

# PCB terminals and connectors OMNIMATE®

Let's connect.



Version 2019





## Dear Customers,

The PDF versions of our catalogues offer practical additional functions, helping you to find your way around our product range and simplifying the ordering process.

In addition to the catalogue, the PDF also contains:

- Internal page links
- Links to the online catalogue

Try it out for yourself. Click the order number to obtain more detailed information and close-up images via your web browser. The links in the PDF file also enable you to go directly to the next desired catalogue page.

Further Weidmüller product catalogues can be accessed by clicking the following:





# PCB terminals and connectors

## OMNIMATE®

### Catalogue 2

PCB terminals and connectors  
OMNIMATE®

Services & products in use

OMNIMATE® Data

OMNIMATE® Signal

PCB terminals

PCB connectors in 2.50 mm pitch

PCB connectors in 3.50 mm pitch

PCB connectors in 3.81 mm pitch

PCB connectors in 5.00 mm and 5.08 mm pitch

PCB connectors Series RSV

Accessories

OMNIMATE® Power

PCB terminals

PCB connectors

Through-Panel Terminals

Accessories

OMNIMATE® Housings

Housings for electronics / Accessories

Weidmüller Support

Technical appendix

Index

Search according to type or order number

Contents

A

B

C

D

E

F

G

H

I

J

K

L

M

N

V

W

X

## Rely on the quality and leading edge of the pioneer in connectivity

With each new generation, device designs are becoming smaller, more economical and offer greater performance. Accordingly, the connection system for more compact sizes must, for example, transfer high currents to the printed circuit board reliably and with minimum losses and also ensure a mechanically stable connection. At the same time, handling should be made safer and more convenient.

Do not leave the success of your device developments to chance. Trust the original OMNIMATE® PCB connection technology. As the inventor of the PCB terminal block and technological leader in device connectivity, Weidmüller offers high-quality components and unique design-in services that promise real added value for your device design.

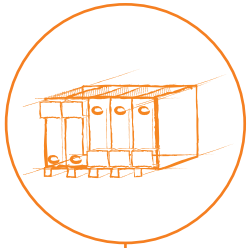

**1960**

### Pioneering accomplishment

Weidmüller brings the worldwide first PCB terminal block onto the market

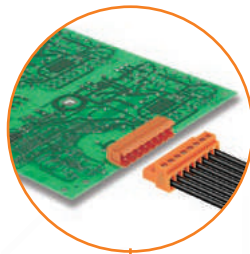

**1980**

### Groundbreaking

The first plug-in connector for the PCB connection still today defines a connector face standard



**2003**

### Creative

Power connectors up to 16 mm<sup>2</sup> with mounting flange simplify safe connection and release

**PUSH IN**

**1978**

### Progressive

The PUSH IN connection technology is used for the very first time in a PCB terminal block



**1999**

### Efficient

The first male header for the SMT reflow soldering processing is launched



**Your way to the right product  
The AppGuide**

You can search for ways to successfully implement ideas for an application. Simply select your device application in our AppGuide, and we will recommend a range of products for all the different functions of your device.

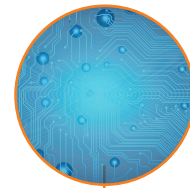

**20xx  
Visionary**

We develop products and technologies for the industrial infrastructure of the future



**2016  
New**

Compact PUSH IN terminal blocks set new standards in efficiency and reliability



**2009  
Innovative**

With the hybrid motor connector, Weidmüller provides the first single cable interface for drives

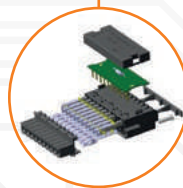

**2018  
Smart**

The BL I/O CJC integrates electronics into a PCB plug-in connector for the first time



**2019  
Digital**

The digital twin of all components as the key to Industry 4.0

OMNIMATE®  
Services

**2013  
Unique**

AppGuide, 72-hour sample service and configurators are just some of the diverse planning and support tools

# Your ideas need the right connections Ours are simply brilliant

## OMNIMATE® Data

Plug-in connectors and jacks for data transmission are already an integral part of the future-proof device design. In the industrial environment, they have to stand up to exacting requirements and the ever-increasing data transmission rates demand high-quality on individual components. The Weidmüller data connectors provide convincing solutions. RJ45 and USB plug-in connectors ensure a safe and efficient interface to your device. The fully shielded product range boasts high levels of electromagnetic compatibility, caters to all established outlet angles, and includes latching hooks on the top and bottom as well as an innovative STEADYTEC® connection system for an industry standard design. Benefit from using our coordinated and high-performance components and a wide range of potential applications.



## OMNIMATE® Signal

A reliable device connection is an absolute must for your customised applications. Thanks to OMNIMATE® Signal, we can now offer you the appropriate connection technology to meet your exact requirements.

You can also choose products from a product range that includes extremely compact PCB terminals and connectors, which thanks to intelligent locking concepts and high-performance connection technologies, provides your design-in-process with a wide range of application-specific solutions and does not set any limits on your creativity.

We have also not forgotten about your production processes when formulating our product range, as our THR and SMD components ensure the highest productivity levels during the reflow soldering process.





## OMNIMATE® Power

New products and innovations help to shake up the market. Many power electronics applications are constantly evolving at a rapid pace, resulting in the requirements placed on connection systems also increasing.

As we are specialists with a great deal of practical experience, we know the maximum power and security requirements that you place on your electronic devices. Our high-performance PCB terminals, connectors and feed-through terminals therefore meet the relevant device standards, e.g. IEC 61800, for speed-controlled drive technology. Our power products also fully achieve 600 volts in accordance with UL standards.

Application-specific connectors for motor connections with shield support round off the product range.

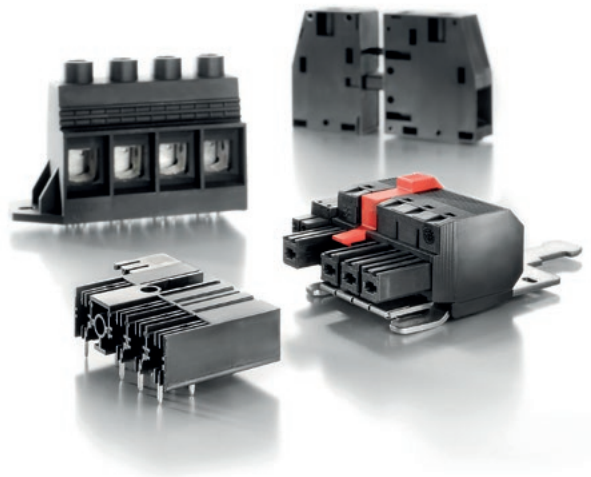

## OMNIMATE® Housings

Your electronics are ready. Are you now only missing the appropriate universal housing? If so, you've come to the right place! OMNIMATE® provides your electronics with a future-proof packaging.

And the best thing about this is that our wide range of housing platforms guarantee the highest degree of modularity while simultaneously delivering an individual design for each application and application area in your product series. In doing so, the maximum layout area and maximum amount of installation space is provided.

For example, our modular CH20M component housing has a high degree of flexibility and variability, as well as an unrivalled compactness. The PCBs in the housings offer the maximum exterior dimensions for fully automatic reflow processability. The patented universal DIN rail system bus ensures that power can be supplied, connected and distributed with ease.

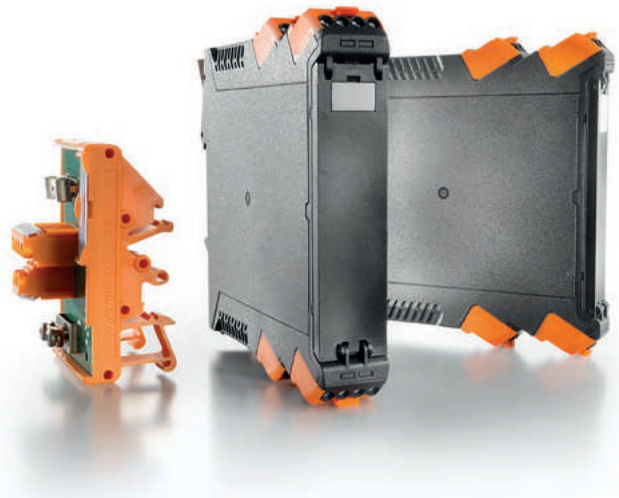

**OMNIMATE® Data – PCB jacks and plug-in connectors**

**PCB-jacks**



**RJ45 solder connection for (THT)**  
PCB jack for wave soldering process

- Outlet direction: 90° und 180°
- Catch mechanism: top and bottom
- Category: up to Cat 6
- Plugging cycles: 750
- With / without LEDs

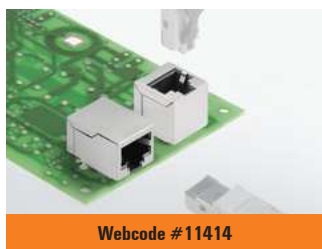

**RJ45 solder connection (THR)**  
PCB jack for reflow and wave soldering process

- Outlet direction: 90° und 180°
- Catch mechanism: top and bottom
- Category: up to Cat 6
- Plugging cycles: 750
- With / without LEDs



**RJ45 solder connection for (SMT)**  
PCB jack for reflow soldering process

- Outlet direction: 90° und 180°
- Catch mechanism: top and bottom
- Category: up to Cat 5
- Plugging cycles: 750
- With / without LEDs

**RJ45 transformer jacks**



**RJ45 solder connection for (THT)**  
PCB jack for wave soldering process

- Integrated magnetics
- Outlet direction: 90°
- Catch mechanism: top and bottom
- Power class: up to 1Gbit/s
- Plugging cycles: 750



**RJ45 solder connection (THR)**  
PCB jack for reflow and wave soldering process

- Integrated magnetics
- Outlet direction: 90° und 180°
- Catch mechanism: top and bottom
- Power class: up to 1Gbit/s
- Plugging cycles: 750
- With / without LEDs



**RJ45 solder connection (THT) multiport**  
PCB jack for wave soldering process

- Integrated magnetics
- Outlet direction: 90°
- Catch mechanism: top and bottom
- Power class: up to 1Gbit/s
- Plugging cycles: 750



**RJ45 solder connection (THR) multiport**  
PCB jack for wave soldering process

- Integrated magnetics
- Outlet direction: 90°
- Catch mechanism: top and bottom
- Power class: up to 1Gbit/s
- Plugging cycles: 750

**USB jacks**



**USB 3.0/2.0 solder connection (THT)**  
PCB jack for wave soldering process

- Outlet direction: 90° und 180°
- Power class: up to 5 Gbit/s
- Plugging cycles: ≥1,500
- Packed in tray



**USB 3.0 solder connection (THR)**  
PCB jack for reflow and wave soldering process

- Outlet direction: 90° und 180°
- Power class: up to 5 Gbit/s
- Plugging cycles: ≥1,500
- Packed in tray or ToR



**USB 2.0 solder connection for (SMT)**  
PCB jack for reflow soldering process (SMT)

- Outlet direction: 90° und 180°
- Power class: up to 5 Gbit/s
- Plugging cycles: ≥1,500
- Packed in ToR

**OMNIMATE® Signal – PCB terminals**

**Clamping yoke screw connection**

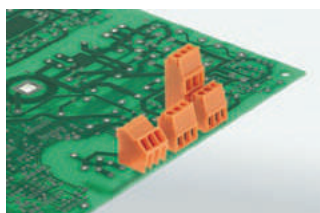

Webcode #01011

**LM 3.50 / LM1N / LM2N**

Small, compact PCB terminal with conductor outlet direction of 90° or 135°.

- Clamping yoke screw connection
- Pitch: 3.50 mm
- Number of poles: 2-12
- IEC: 320 V / 16 A / 0.2-1.5 mm<sup>2</sup>
- UL: 300 V / 10 A / AWG 28-14

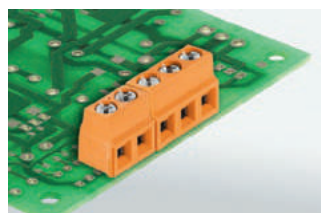

Webcode #01015

**LS 5.08**

Small, compact PCB terminal with conductor outlet direction of 90°.

- Clamping yoke screw connection
- Pitch: 5.08 mm
- Number of poles: 2-12
- IEC: 630 V / 17.5 A / 0.08-1.5 mm<sup>2</sup>
- UL: 300 V / 15 A / AWG 28-14

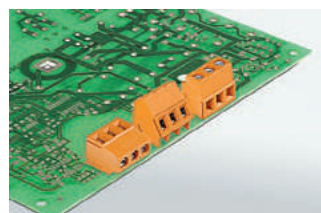

Webcode #01013

**LM 5.00/5.08**

Single-row PCB terminal with conductor outlet direction of 90°, 135° and 180°.

- Clamping yoke screw connection
- Pitch: 5.00 mm / 5.08 mm
- Number of poles: 2-24
- IEC: 630 V / 17.5 A / 0.2-2.5 mm<sup>2</sup>
- UL: 300 V / 15 A / AWG 24-14

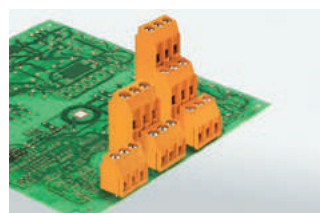

Webcode #01017

**LL 5.00/5.08**

Single-row PCB terminal with conductor outlet direction of 90° and 180°.

- Clamping yoke screw connection
- Pitch: 5.00 mm / 5.08 mm
- Number of poles: 2-24
- IEC: 500 V / 32.5 A / 0.5-6 mm<sup>2</sup>
- UL: 300 V / 20 A / AWG 28-12

**Clamping yoke screw connection**

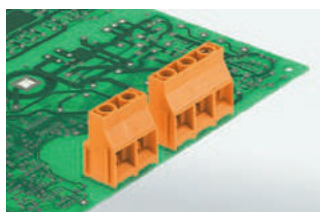

Webcode #01019

**LL 9.52**

Single-row PCB terminal with conductor outlet direction of 90°.

- Clamping yoke screw connection
- Pitch: 9.52 mm
- Number of poles: 2-3
- IEC: 1,000 V / 32 A / 0.18-6 mm<sup>2</sup>
- UL: 300 V / 30 A / AWG 26-10

**TOP screw connection**

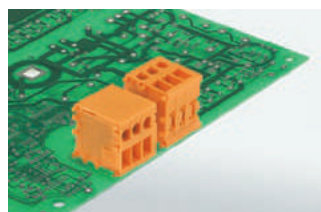

Webcode #01025

**TOP**

PCB terminal with conductor insertion and contact point actuation from the same direction.

- TOP screw connection
- Pitch: 5.08 mm / 6.35 mm / 7.62 mm
- Number of poles: 2-24
- IEC: 630 V / 24 A / 0.2-2.5 mm<sup>2</sup>
- UL: 300 V / 10 A / AWG 26-14

**Leaf-spring screw connection**

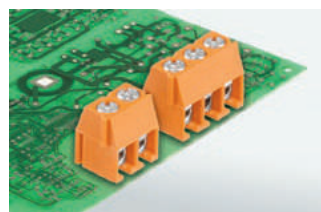

Webcode #01021

**PS 3.5**

Very small and compact PCB terminal with conductor outlet direction of 90°.

- Leaf-spring screw connection
- Pitch: 3.50 mm
- Number of poles: 2-12
- IEC: 320 V / 17.5 A / 0.2-1.5 mm<sup>2</sup>
- UL: 300 V / 10 A / AWG 28-16

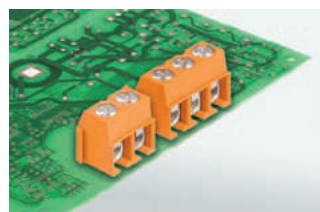

Webcode #01023

**PM 5.00/5.08**

PCB terminal with conductor inlet direction of 90°.

- Leaf-spring screw connection
- Pitch: 5.00 mm / 5.08 mm
- Number of poles: 2-12
- IEC: 600 V / 24 A / 0.13-2.5 mm<sup>2</sup>
- UL: 300 V / 15 A / AWG 26-14

**PUSH IN spring connection**

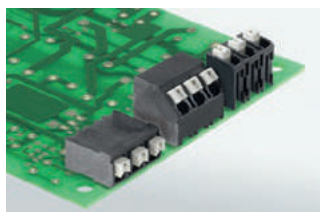

Webcode #01029

**LSF-SMT 3.5 / 3.81**

PCB terminal for fully automatic assembly for THR reflow soldering (SMT) and wave soldering.

- PUSH IN spring connection
- Pitch: 3.50 mm / 3.81 mm
- Number of poles: 2-24
- IEC: 320 V / 17.5 A / 0.2-1.5 mm<sup>2</sup>
- UL: 300 V / 12 A / AWG 24-16

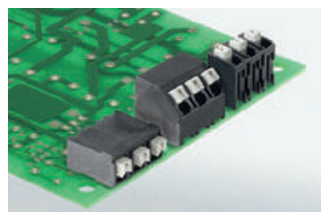

Webcode #01031

**LSF-SMT 5.00 / 5.08**

PCB terminal for fully automatic assembly for THR reflow soldering (SMT) and wave soldering.

- PUSH IN spring connection
- Pitch: 5.00 mm / 5.08 mm
- Number of poles: 2-8
- IEC: 500 V / 17.5 A / 0.2-1.5 mm<sup>2</sup>
- UL: 300 V / 12 A / AWG 24-16

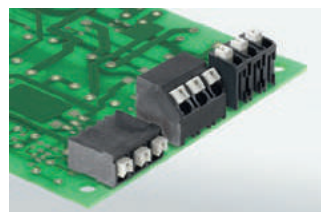

Webcode #01033

**LSF-SMT 7.50 / 7.62**

PCB terminal for fully automatic assembly for THR reflow soldering (SMT) and wave soldering.

- PUSH IN spring connection
- Pitch: 7.50 mm / 7.62 mm
- Number of poles: 2-8
- IEC: 800 V / 17.5 A / 0.2-1.5 mm<sup>2</sup>
- UL: 300 V / 12 A / AWG 24-16

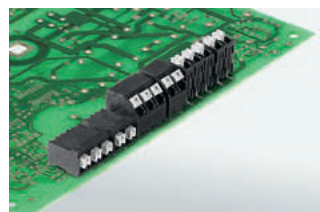

Webcode #01035

**LSF-SMD 3.5**

PCB terminal for fully automatic assembly for reflow soldering (SMT).

- PUSH IN spring connection
- Pitch: 3.50 mm
- Number of poles: 2-12
- IEC: 320 V / 17.5 A / 0.2-1.5 mm<sup>2</sup>
- UL: 300 V / 12 A / AWG 24-16

**OMNIMATE® Signal – PCB terminals**

**PUSH IN spring connection**

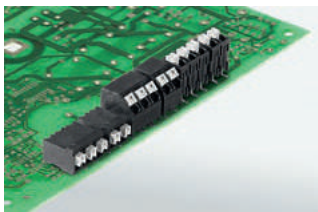

**Webcode #01037**

**LSF-SMD 5.00**

PCB terminal for fully automatic assembly for reflow soldering (SMT).

- PUSH IN spring connection
- Pitch: 5.00 mm
- Number of poles: 2-8
- IEC: 500 V / 17.5 A / 0.2-1.5 mm<sup>2</sup>
- UL: 300 V / 12 A / AWG 24-16

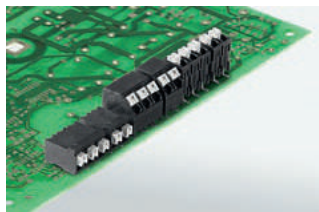

**Webcode #01039**

**LSF-SMD 7.50**

PCB terminal for fully automatic assembly for reflow soldering (SMT).

- PUSH IN spring connection
- Pitch: 7.50 mm
- Number of poles: 2-6
- IEC: 800 V / 17.5 A / 0.2-1.5 mm<sup>2</sup>
- UL: 300 V / 12 A / AWG 24-16

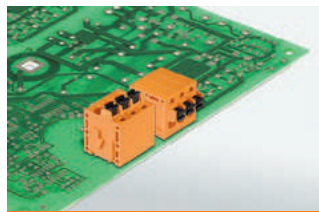

**Webcode #01041**

**LMF 5.00/5.08**

PCB terminal with pusher for opening the contact point and an integrated test point.

- PUSH IN spring connection
- Pitch: 5.00 mm / 5.08 mm
- Number of poles: 2-24
- IEC: 400 V / 24 A / 0.2-2.5 mm<sup>2</sup>
- UL: 300 V / 10 A / AWG 26-12

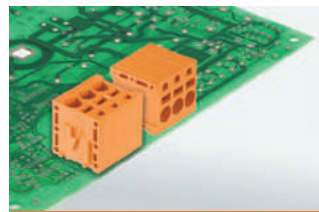

**Webcode #01043**

**LMFS 5.00/5.08**

PCB terminal without pusher; contact point can be opened using a screwdriver and integrated test point.

- PUSH IN spring connection
- Pitch: 5.00 mm / 5.08 mm
- Number of poles: 2-24
- IEC: 400 V / 24 A / 0.2-2.5 mm<sup>2</sup>
- UL: 300 V / 10 A / AWG 26-12

**PUSH IN spring connection**

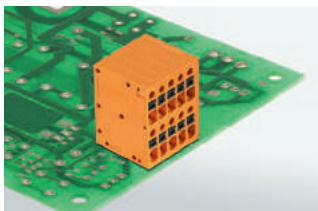

**Webcode #01027**

**LS2HF 3.50**

Double-storey PCB terminal for wave soldering processes, with conductor insertion and slider operation from the same direction (TOP).

- PUSH IN spring connection
- Pitch: 3.50 mm
- Number of poles: 4-24
- IEC: 400 V / 10 A / 0.14-1.5 mm<sup>2</sup>
- UL: 150 V / 12.5 A / AWG 26-16

**Tension clamp connection**

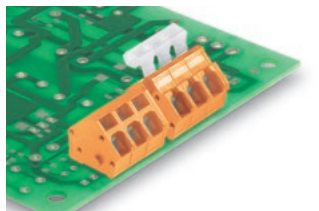

**Webcode #11448**

**LMZF**

Single-row PCB terminal with maintenance-free tension clamp connection and with conductor outlet direction of 135°.

- Tension clamp connection
- Pitch: 5, 7 & 10 mm
- Number of poles: 2-24
- IEC: 630 V/24 A / 0.13 - 2.5 mm<sup>2</sup>
- UL: 300 V/15 A / AWG 26-AWG 14

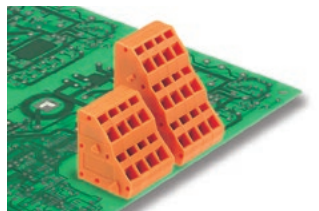

**Webcode #11447**

**LM2NZF & LM3RZF**

Multi-level PCB terminal with conductor outlet direction of 135°.

- Tension clamp connection
- Pitch: 5.08 mm
- Number of poles: 2-24
- IEC: 630 V/24 A / 0.13 - 2.5 mm<sup>2</sup>
- UL: 300 V/15 A / AWG 26-AWG 14

**OMNIMATE® Signal – PCB connectors**

**Pitch 2.50 mm**



**BLF 2.50**  
Female plug for conductor connection with PUSH IN spring connection.

- PUSH IN spring connection
- Pitch: 2.50 mm
- Number of poles: 2-12
- IEC: 320 V / 6 A / 0.08 - 0.5 mm<sup>2</sup>
- UL: 150 V / 5 A / AWG 28 - 20



**SL 2.50**  
Male header for wave soldering methods for 2.50 mm pitch.

- Male header
- Pitch: 2.50 mm
- Number of poles: 2-12
- IEC: 320 V / 6 A
- UL: 320 V / 6 A

**Pitch 3.50 mm double-row design**

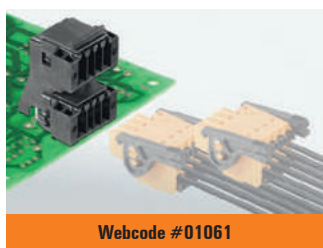

**S2C 3.50**  
High-temperature-resistant, double-row male header for reflow and wave soldering methods.

- Male header
- Pitch: 3.50 mm
- Number of poles: 4-36
- IEC: 200 V / 13.4 A
- UL: 150 V / 10 A

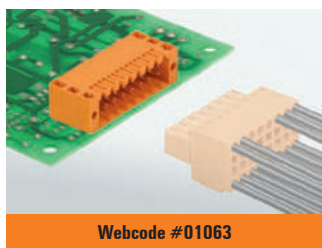

**S2L 3.50**  
Double-row male header for wave soldering methods.

- Male header
- Pitch: 3.50 mm
- Number of poles: 6-36
- IEC: 250 V / 10 A
- UL: 150 V / 10 A

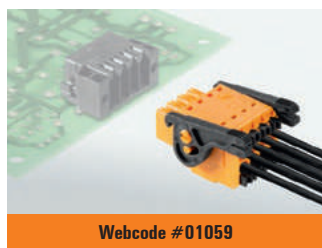

**B2CF 3.50**  
Compact double-row female plug with maximum connection density within an extremely small space.

- PUSH IN spring connection
- Pitch: 3.50 mm
- Number of poles: 4-36
- IEC: 320 V / 13.4 A / 0.14-1.5 mm<sup>2</sup>
- UL: 300 V / 9.5 A / AWG 26-16

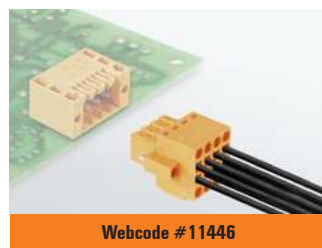

**B2L 3.50**  
Double-row female plug with Tension clamp connection.

- Tension clamp connection
- Pitch: 3.50 mm
- Number of poles: 4-36
- IEC: 200 V / 10.3 A / 0.2-1 mm<sup>2</sup>
- UL: 300 V / 10 A / AWG 28-AWG 16

**Pitch 3.50 mm**

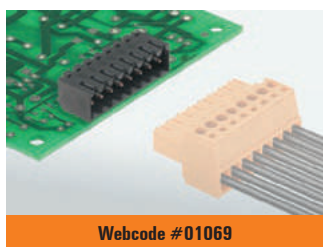

**SL-SMT 3.50**  
High-temperature-resistant male header for reflow and wave soldering methods.

- Male header
- Pitch: 3.50 mm
- Number of poles: 2-24
- IEC: 320 V / 15 A
- UL: 300 V / 10 A

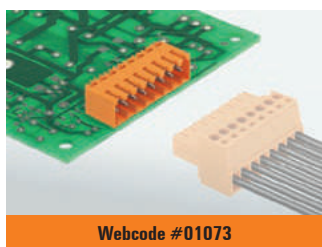

**SL 3.50**  
Male header for wave soldering methods.

- Male header
- Pitch: 3.50 mm
- Number of poles: 2-24
- IEC: 320 V / 17 A
- UL: 300 V / 10 A

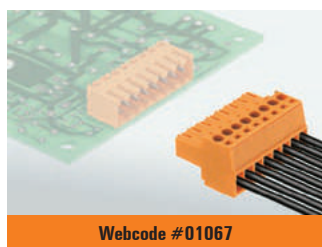

**BL 3.50**  
Female plug for conductor connection with clamping yoke screw connection.

- Clamping yoke screw connection
- Pitch: 3.50 mm
- Number of poles: 2-24
- IEC: 320 V / 17 A / 0.2-1.5 mm<sup>2</sup>
- UL: 300 V / 10 A / AWG 28-14

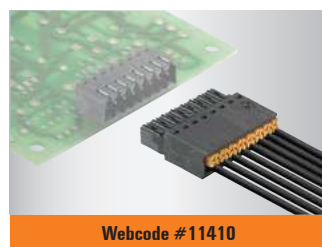

**BLF 3.5**  
Female plug with PUSH IN spring connection

- PUSH IN spring connection
- 3.50 mm pitch
- Number of poles: 2-24
- IEC: 320 V / 14.5 A
- UL: 300 V / 9.5 A

**OMNIMATE® Signal – PCB connectors**

**Pitch 3.50 mm**

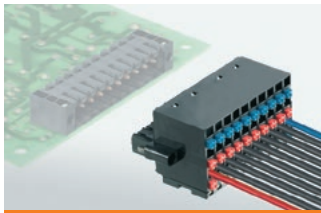

Webcode #01065

**BL I/O 3.5**

Extremely compact female plug in one or three-row design and with an integrated LED display.

- PUSH IN spring connection
- Pitch: 3.50 mm
- Number of poles: 10–30
- IEC: 200 V / 2.2 A / 0.2–1 mm<sup>2</sup>
- UL: 50 V / 5 A / AWG 24–16



Webcode #11445

**BL I/O CJC**

Compact female plug with integrated cold junction compensation.

- PUSH IN spring connection
- Pitch: 3.50 mm
- Number of poles: 10
- IEC: 50V / 2,2 A / 0,2 - 1,5 mm<sup>2</sup>
- UL: 50 V / 5 A / AWG 24 - 16

**Pitch 3.81 mm**

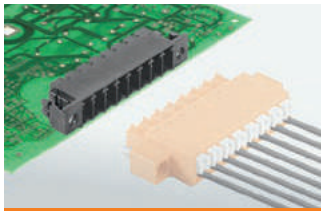

Webcode #01077

**SC-SMT 3.81**

High-temperature-resistant male header with a very low profile for reflow and wave soldering methods.

- Male header
- Pitch: 3.81 mm
- Number of poles: 2–16
- IEC: 320 V / 17.5 A
- UL: 300 V / 10 A

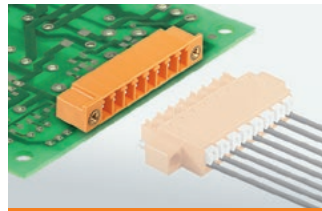

Webcode #01081

**SC 3.81**

Male header with a very low profile for wave soldering methods.

- Male header
- Pitch: 3.81 mm
- Number of poles: 2–20
- IEC: 320 V / 17.5 A
- UL: 300 V / 10 A



Webcode #11333

**SCZ 3.81**

Compact male plug for conductor connection with clamping yoke screw connection.

- Clamping yoke screw connection
- Pitch: 3.81 mm
- Number of poles: 2–12
- IEC: 320 V / 17.5 A / 0.14–1.5 mm<sup>2</sup>
- UL: 300 V / 10 A / AWG 28–16

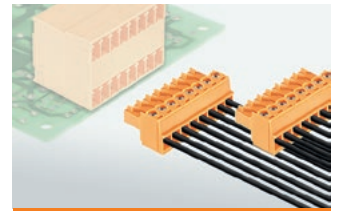

Webcode #01075

**BCZ 3.81**

Compact female plug for conductor connection with clamping yoke screw connection.

- Clamping yoke screw connection
- Pitch: 3.81 mm
- Number of poles: 2–20
- IEC: 320 V / 17.5 A / 0.14–1.5 mm<sup>2</sup>
- UL: 300 V / 10 A / AWG 28–16

**Pitch 3.81 mm**

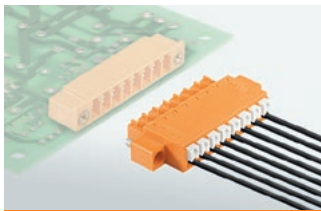

Webcode #01079

**BCF 3.81**

Female plug with very low profile for conductor connection with PUSH IN spring connection.

- PUSH IN spring connection
- Pitch: 3.81 mm
- Number of poles: 2–18
- IEC: 320 V / 17.5 A / 0.2–1.5 mm<sup>2</sup>
- UL: 300 V / 10 A / AWG 28–16

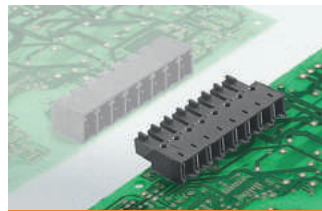

Webcode #01083

**BCL-SMT 3.81**

High-temperature-resistant female header with a very low profile for reflow soldering methods.

- Female header
- Pitch: 3.81 mm
- Number of poles: 2–12
- IEC: 320 V / 17.5 A
- UL: 300 V / 10 A

**OMNIMATE® Signal – PCB connectors**

**Pitch 5.00 mm**

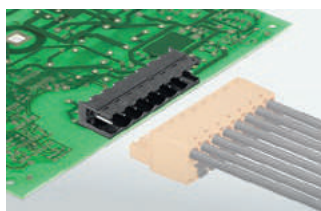

**Webcode #11444**

**SL-SMT 5.00HC**

High-temperature-resistant, bent pin header, optimized for automatic assembly and reflow and wave soldering.

- Male header
- Pitch: 5.00 mm
- Number of poles: 2-24
- IEC: 400 V / 27.5 A
- UL: 300 V / 18.5 A

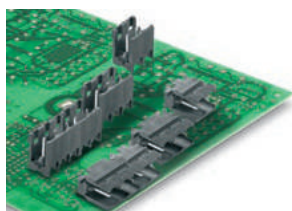

**Webcode #11443**

**SL-SMaRT 5.0xHC**

High-temperature-resistant, Modular pin header.

- High-current male header
- Pitch: 5.0x mm
- Number of poles: 2 & 3
- IEC: 400 V / 27.5 A
- UL: 300 V / 15 A

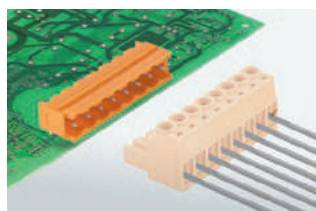

**Webcode #01095**

**SL 5.00**

Pin headers with solder pin length optimized for wave flow soldering.

- Male header
- Pitch: 5.00 mm
- Number of poles: 2-24
- IEC: 400 V / 24 A
- UL: 300 V / 18.5 A

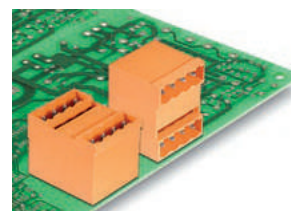

**Webcode #11461**

**SLD 5.00**

2-tier male header with parallel pin arrangement with outlet direction of 90° & 180°, optimized for wave soldering methods.

- Male header
- Pitch: 5.00 mm
- Number of poles: 4-48
- IEC: 400 V / 15 A
- UL: 300 V / 10 A

**Pitch 5.00 mm**

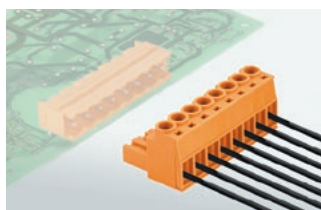

**Webcode #01165**

**BLZP 5.00HC**

High-current-female-plug for outlet direction of 90°, 180°, 225° or 270°.

- Clamping yoke screw connection
- Pitch: 5.00 mm
- Number of poles: 2-24
- IEC: 400 V / 23 A / 0.2-4 mm<sup>2</sup>
- UL: 300 V / 20 A / AWG 30-12

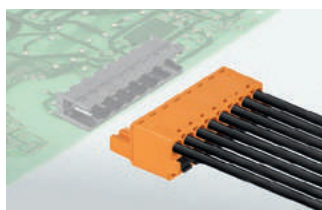

**Webcode #11442**

**BLF 5.00HC**

Compact high-current-female-plug for outlet direction of 90°, 180° or 270°.

- PUSH IN spring connection
- Pitch: 5.00 mm
- Number of poles: 2-24
- IEC: 400 V / 24 A / 0.2-2.5 mm<sup>2</sup>
- UL: 300 V / 18.5 A / AWG 26-12

**Pitch 5.08 mm**

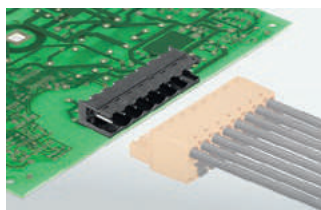

**Webcode #01091**

**SL-SMT 5.08HC**

Highly temperature-resistant angled male header optimised for automatic assembly and for reflow and wave soldering methods.

- Male header
- Pitch: 5.08 mm
- Number of poles: 2-24
- IEC: 400 V / 27.5 A
- UL: 300 V / 18.5 A

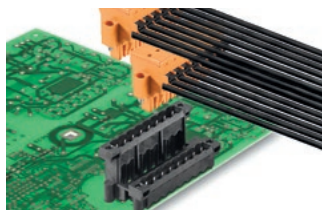

**Webcode #11441**

**SLDV-THR 5.08**

High-temperature resistant, double level, laterally offset, male connector with flange or solder flange.

- Male header
- Pitch: 5.08 mm
- Number of poles: 4-48
- IEC: 400 V / 15 A
- UL: 300 V / 10 A

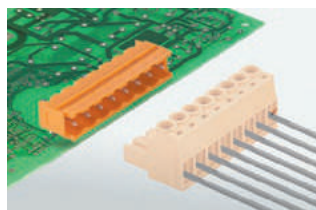

**Webcode #01095**

**SL 5.08HC**

Male headers in glass-fibre-reinforced plastic, optimised for wave soldering methods.

- Male header
- Pitch: 5.08 mm
- Number of poles: 2-24
- IEC: 400 V / 24 A
- UL: 300 V / 18.5 A

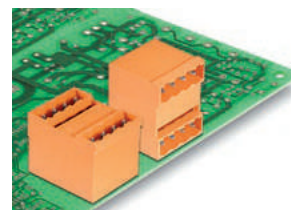

**Webcode #11440**

**SLD 5.08**

2-tier male header with parallel or laterally offset pin arrangement with with outlet direction of 90° & 180°, optimized for wave soldering methods.

- Male header, parallel or laterally offset
- Pitch: 5.08 mm
- Number of poles: 4-48
- IEC: 400 V / 15 A
- UL: 300 V / 10 A

**OMNIMATE® Signal – PCB connectors**

**Pitch 5.08 mm**

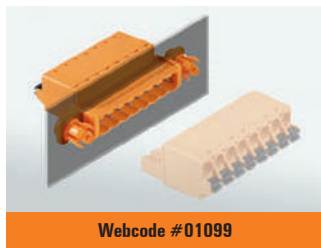

Webcode #01099

**SLF 5.08**  
Male plugs with straight outlet direction provide space for labelling and can be coded.

- PUSH IN spring connection
- Pitch: 5.08 mm
- Number of poles: 2-12
- IEC: 400 V / 25.9 A / 0.2-2.5 mm<sup>2</sup>
- UL: 300 V / 14 A / AWG 26-12



Webcode #01087

**SLS 5.08**  
Male plug with clamping-yoke screw wire-connect system.

- Clamping yoke screw connection
- Pitch: 5.08 mm
- Number of poles: 2-24
- IEC: 400 V/21.5 A / 0.2-2.5 mm<sup>2</sup>
- UL: 300 V/14 A / AWG 26-AWG 12

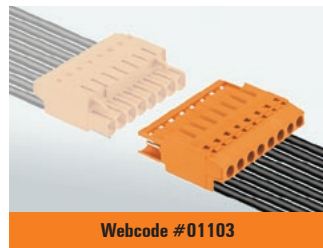

Webcode #01103

**SLT 5.08**  
Male plugs with straight outlet direction provide space for labelling and can be coded.

- TOP screw connection system
- Pitch: 5.08 mm
- Number of poles: 2-16
- IEC: 400 V / 16 A / 0.2-2.5 mm<sup>2</sup>
- UL: 300 V / 15 A / AWG 26-14



Webcode #01085

**BLZP 5.08HC**  
High-current female plug for conductor connection with 90°, 180° to 225° and 270° outlet direction.

- Clamping yoke screw connection
- Pitch: 5.08 mm
- Number of poles: 2-24
- IEC: 400 V / 23 A / 0.2-4 mm<sup>2</sup>
- UL: 300 V / 20 A / AWG 30-12

**Pitch 5.08 mm**



Webcode #01093

**BLT 5.08HC**  
High-current female plug for conductor connection with a straight 180° outlet direction and space for labelling.

- TOP screw connection
- Pitch: 5.08 mm
- Number of poles: 2-24
- IEC: 400 V / 27 A / 0.2-2.5 mm<sup>2</sup>
- UL: 300 V / 17 A / AWG 26-14



Webcode #01089

**BLF 5.08HC**  
Compact high-current female plug for conductor outlet directions of 90° to 180° and 270°.

- PUSH IN spring connection
- Pitch: 5.08 mm
- Number of poles: 2-24
- IEC: 400 V / 24 A / 0.2-2.5 mm<sup>2</sup>
- UL: 300 V / 18.5 A / AWG 26-12

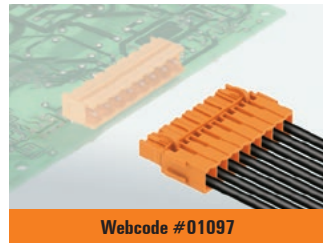

Webcode #01097

**BLC 5.08**  
Female plug to allow for the pre-assembly of wiring harnesses in large quantities.

- Crimp connection system
- Pitch: 5.08 mm
- Number of poles: 2-16
- IEC: 400 V / 21 A
- UL: 300 V / 10 A / AWG 26-14

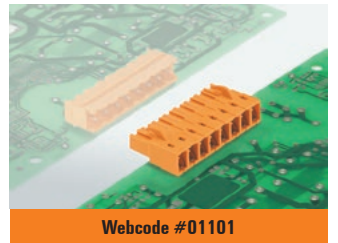

Webcode #01101

**BLL 5.08**  
Female header for PCB assembly with 90° and 180° outlet direction and optimised solder pin length for wave soldering methods.

- Female header
- Pitch: 5.08 mm
- Number of poles: 2-24
- IEC: 400 V / 23 A
- UL: 300 V / 15 A

**Rectangular connector**



Webcode #11361

**RSV 1.6 C**  
Rectangular connector for a high component density, for use as a free coupling or a PCB variant.

- Crimp connection system
- Pitch: 5.00 mm
- Number of poles: 4-36
- IEC: 630 V / 17 A
- UL: 600 V / 10 A / AWG 26-12



Webcode #01107

**RSV 1.6 L**  
Rectangular connector with solder pin and solder jack contacts for PCB applications.

- Solder pin contacts
- Pitch: 5.00 mm
- Number of poles: 4-36
- IEC: 500 V / 14 A
- UL: 300 V / 10 A

**Accessories**



Webcode #11439

**Accessories**  
For signal PCB terminals



Webcode #11438

**Accessories**  
For signal PCB connectors



**OMNIMATE® Power PCB terminals**

**Clamping yoke screw connection**

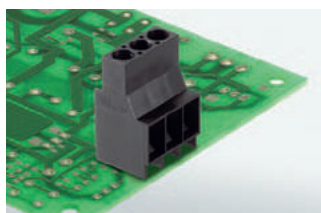

Webcode #01045

**LL 6.35**

High-performance PCB terminal with offset solder pins and conductor outlet direction of 90°.

- Clamping yoke screw connection
- Pitch: 6.35 mm
- Number of poles: 2-12
- IEC: 1,000 V / 32 A / 0.18-6 mm<sup>2</sup>
- UL: 600 V / 30 A / AWG 26-10



Webcode #01049

**LU 10.16**

High-performance PCB terminal with offset solder pins and conductor outlet direction of 90°.

- Clamping yoke screw connection
- Pitch: 10.16 mm
- Number of poles: 2-10
- IEC: 1,000 V / 76 A / 0.5-16 mm<sup>2</sup>
- UL: 300 V / 65 A / AWG 26-6

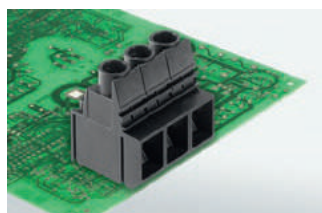

Webcode #01051

**LUP 10.16 V with test point**

High-performance PCB terminal with integrated test point and conductor outlet direction of 90°.

- Clamping yoke screw connection
- Pitch: 10.16 mm
- Number of poles: 2-9
- IEC: 1,000 V / 76 A / 0.5-16 mm<sup>2</sup>
- UL: 600 V / 51 A / AWG 26-6

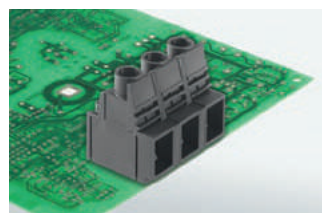

Webcode #01053

**LUP 12.70 with test point**

High-performance PCB terminal with integrated test point and conductor outlet direction of 90°.

- Clamping yoke screw connection
- Pitch: 12.70 mm
- Number of poles: 2-9
- IEC: 1,000 V / 76 A / 0.5-16 mm<sup>2</sup>
- UL: 600 V / 58 A / AWG 26-6

**Clamping yoke screw connection**

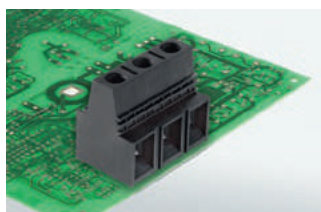

Webcode #01055

**LX 15.00 with test point**

High-performance PCB terminal with integrated test point and conductor outlet direction of 90°.

- Clamping yoke screw connection
- Pitch: 15.00 mm
- Number of poles: 1-9
- IEC: 1,000 V / 101 A / 1.5-25 mm<sup>2</sup>
- UL: 600 V / 85 A / AWG 16-4



Webcode #01057

**LXXX 15.00 with test point**

High-performance PCB terminal with integrated test point and conductor outlet direction of 90°.

- Clamping yoke screw connection
- Pitch: 15.00 mm
- Number of poles: 1-9
- IEC: 1,000 V / 150 A / 0.5-50 mm<sup>2</sup>
- UL: 600 V / 127 A / AWG 20-1

**PUSH IN spring connection**

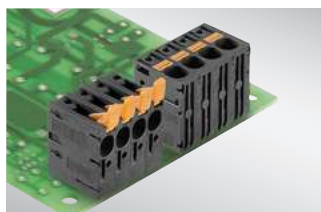

Webcode #11408

**LLF / LLFS 7.5**

Highly reliable PCB terminals with integrated test point and conductor outlet direction of 90° and 180°

- PUSH IN spring connection
- Fast wiring without tool (LLF 7.50)
- Pitch: 7.5 mm
- Number of poles: 1-12
- IEC: 1,000 V / 41 A / 0.5-6 mm<sup>2</sup>
- UL: 600 V / 35 A / AWG 24-8



Webcode #01046

**LUF / LUFS 10**

Highly reliable PCB terminals with integrated test point and conductor outlet direction of 90° and 180°

- PUSH IN spring connection
- Fast wiring without tool (LUF10)
- Pitch: 10.00 mm
- Number of poles: 1-12,
- IEC: 1,000 V / 76 A / 0.5-16 mm<sup>2</sup>
- UL: 600 V / 61 A / AWG 18-6

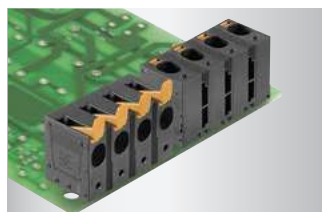

Webcode #11409

**LUF / LUFS 15**

Highly reliable PCB terminals with integrated test point and conductor outlet direction of 90° and 180°

- PUSH IN spring connection
- Fast wiring without tool (LUF 15)
- Pitch: 15.00 mm
- Number of poles: 2-8
- IEC: 1,000 V / 76 A / 0.5-16 mm<sup>2</sup>
- UL: 1,000 V / 57 A / AWG 18-6

**OMNIMATE® Power – PCB connectors**

**OMNIMATE® Power Hybrid**



**SV-SMT 7.62 Hybrid**  
High-temperature-resistant hybrid male header with energy and signal contacts.

- Male header
- Pitch: 7.62 mm
- Number of poles: 2-5
- IEC: 1,000 V / 41 A
- UL: 300 V / 35 A



**SV 7.62 hybrid**  
Hybrid male header with energy and signal contacts.

- Male header
- Pitch: 7.62 mm
- Pole count: 2/4-5/8
- IEC: 1,000 V / 41 A
- UL: 300 V / 35 A



**BVF 7.62HP hybrid**  
Hybrid female plug – the perfect 2-in-1 solution for the simultaneous combination of energy and signals. Available with plug-in EMC shield support on request.

- PUSH IN spring connection
- Pitch: 7.62 mm
- Pole count: 2/4-5/8
- IEC: 1,000 V / 38 A / 0.5-10 mm<sup>2</sup>
- UL: 600 V / 35 A / AWG 24-8

**OMNIMATE® Power IT**



**SL 7.62IT**  
Male header with optional solder flange attachment and with leading contact for computer networks.

- Male header
- Pitch: 7.62 mm
- Number of poles: 2-6
- IEC: 630 V / 29 A
- UL: 300 V / 20 A

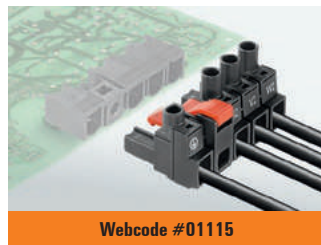

**BLZ 7.62IT**  
Female plug with 180° outlet direction and touch safety for IT networks with self-locking centre flange.

- Clamping yoke screw connection
- Pitch: 7.62 mm
- Number of poles: 2-6
- IEC: 1,000 V / 41 A / 0.2-6 mm<sup>2</sup>
- UL: 600 V / 40.5 A / AWG 24-8

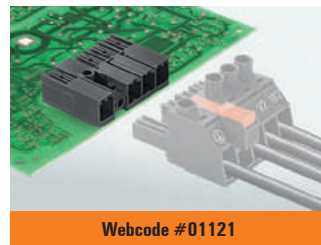

**BV 7.62IT**  
Male header with optional solder flange attachment and with leading contact for computer networks.

- Male header
- Pitch: 7.62 mm
- Number of poles: 2-4
- IEC: 1,000 V / 41 A
- UL: 300 V / 40.5 A

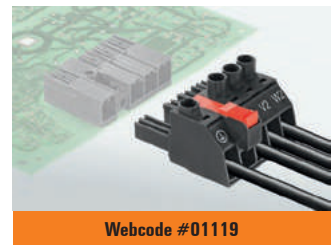

**BVZ 7.62IT**  
Female plug with 180° outlet direction and touch safety for IT networks with self-locking centre flange.

- Clamping yoke screw connection
- Pitch: 7.62 mm
- Number of poles: 2-4
- IEC: 1,000 V / 41 A / 0.2-6 mm<sup>2</sup>
- UL: 600 V / 40.5 A / AWG 24-8

**OMNIMATE® Power IT**

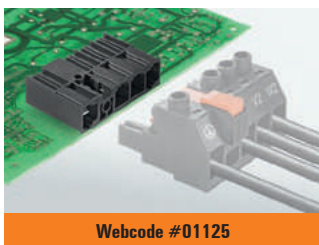

**SU 10.16IT**  
Male header with optional solder flange attachment and with leading contact for computer networks.

- Male header
- Pitch: 10.16 mm
- Number of poles: 2-4
- IEC: 1,000 V / 76 A
- UL: 300 V / 60 A



**BUZ 10.16IT**  
Female plug with 180° outlet direction and touch safety for IT networks with self-locking centre flange.

- Clamping yoke screw connection
- Pitch: 10.16 mm
- Number of poles: 2-4
- IEC: 1,000 V / 78 A / 0.2-16 mm<sup>2</sup>
- UL: 300 V / 60 A / AWG 22-4

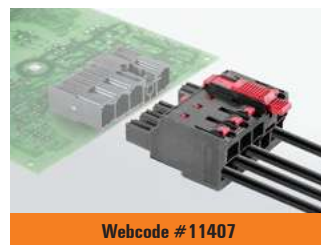

**BUF 10.16IT**  
Female plug with 180° outlet direction for IT networks with self-locking centre flange

- PUSH IN spring connection
- Pitch: 10.16 mm
- Number of poles: 2-5
- IEC: 1,000 V / 76 A / 2.5 - 16 mm<sup>2</sup>
- UL: 600 V / 55 A / AWG 12 - AWG 4

**OMNIMATE® Power – PCB connectors**

**OMNIMATE® Power HP pitch 7.62 mm**

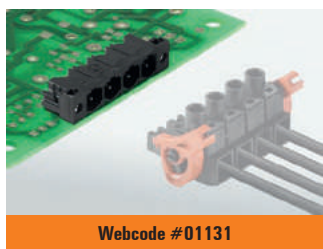

**SL 7.62HP**  
Male header with single compartment mating profile and touch protection.

- Male header
- Pitch: 7.62 mm
- Number of poles: 2-12
- IEC: 630 V / 29 A
- UL: 300 V / 20 A

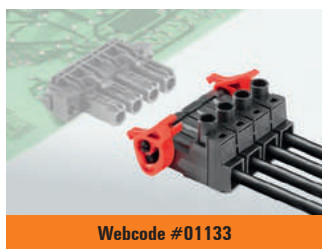

**SLZ 7.62HP**  
Male plug with single compartment mating profile with 180° outlet direction as touch-safe solution for the reverse voltage in HP networks.

- Clamping yoke screw connection
- Pitch: 7.62 mm
- Number of poles: 2-5
- IEC: 1,000 V / 20 A / 0.5-2.5 mm<sup>2</sup>
- UL: 600 V / 17 A / AWG 20-12

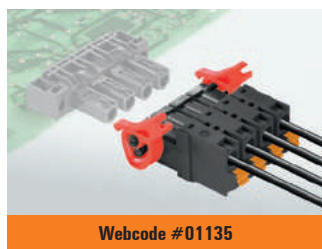

**SLF 7.62HP**  
Male plug with single compartment mating profile with 180° outlet direction as touch-safe solution for the reverse voltage in HP networks.

- PUSH IN spring connection
- Pitch: 7.62 mm
- Number of poles: 2-5
- IEC: 1,000 V / 24 A / 0.5-2.5 mm<sup>2</sup>
- UL: 600 V / 20 A / AWG 20-12

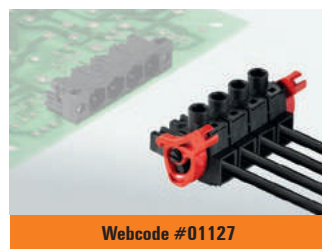

**BLZ 7.62HP**  
Female plug with single compartment mating profile with 180° outlet direction and touch protection for HP networks.

- Clamping yoke screw connection
- Pitch: 7.62 mm
- Number of poles: 2-12
- IEC: 630 V / 29 A / 0.2-4 mm<sup>2</sup>
- UL: 600 V / 20 A / AWG 20-12

**OMNIMATE® Power HP pitch 7.62 mm**

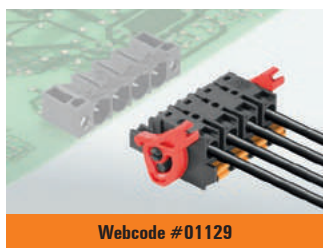

**BLF 7.62HP**  
Female plug with single compartment mating profile with 180° outlet direction and touch protection for HP networks.

- PUSH IN spring connection
- Pitch: 7.62 mm
- Number of poles: 2-12
- IEC: 1,000 V / 24 A / 0.5-2.5 mm<sup>2</sup>
- UL: 600 V / 20 A / AWG 20-12

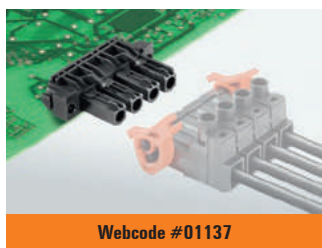

**BLL 7.62HP**  
Touch-safe female header with single compartment mating profile for the PCB with one-hand safety interlock.

- Female header
- Pitch: 7.62 mm
- Number of poles: 2-5
- IEC: 630 V / 24 A
- UL: 300 V / 20 A

**OMNIMATE® Power HP pitch 7.62 mm**



**SV 7.62HP**  
High-performance single-row male header for pole-loss-safe attachment or for use with patented multi-function flanges for TNC(S) networks.

- Male header
- Pitch: 7.62 mm
- Number of poles: 2-12
- IEC: 1,000 V / 41 A
- UL: 300 V / 40.5 A



**SVZ 7.62HP**  
High-performance male plug for pole-loss-safe attachment or for use with patented multi-function flanges for TNC(S) networks.

- Clamping yoke screw connection
- Pitch: 7.62 mm
- Number of poles: 2-7
- IEC: 1,000 V / 41 A / 0.2-6 mm<sup>2</sup>
- UL: 600 V / 35 A / AWG 24-10



**SVF 7.62HP**  
High-performance male plug with 180° outlet direction as a three-flange version for the housing feedthrough for TNC(S) networks.

- PUSH IN spring connection
- Pitch: 7.62 mm
- Number of poles: 2-6
- IEC: 1,000 V / 41 A / 0.5-10 mm<sup>2</sup>
- UL: 600 V / 35 A / AWG 24-10

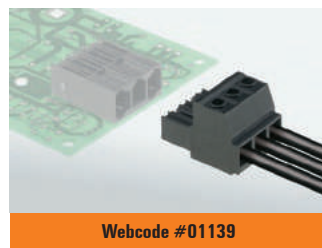

**BVZ 7.62HP**  
High-performance female plug for pole-loss-safe attachment or for use with patented multi-function flanges for TNC(S) networks.

- Clamping yoke screw connection
- Pitch: 7.62 mm
- Number of poles: 2-12
- IEC: 1,000 V / 41 A / 0.2-6 mm<sup>2</sup>
- UL: 600 V / 40.5 A / AWG 24-8

## OMNIMATE® Power – PCB connectors

### OMNIMATE® Power HP pitch 6 mm<sup>2</sup>

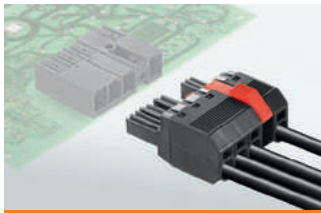

Webcode #01141

#### BVL 7.62HP

High-performance female plug with 180° outlet direction as a touch-safe solution for the power output for TNC(S) networks.

- PUSH IN spring connection
- Pitch: 7.62 mm
- Number of poles: 2-5
- IEC: 1,000 V / 41 A / 0.5-10 mm<sup>2</sup>
- UL: 600 V / 35 A / AWG 24-8



Webcode #01149

#### BVF 7.62HP

High-performance female header for pole-loss-safe attachment or for use with patented multi-function flanges for TNC(S) networks.

- Female header
- Pitch: 7.62 mm
- Number of poles: 2-7
- IEC: 1,000 V / 41 A
- UL: 300 V / 35 A

### OMNIMATE® Power HP pitch 10.16 mm

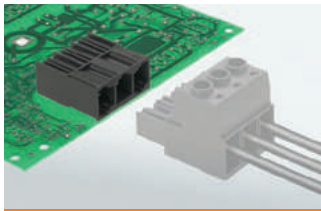

Webcode #01153

#### SUZ 10.16HP

High-performance single-row male header for pole-loss-safe attachment or for use with patented multi-function flanges for TNC(S) networks.

- Male header
- Pitch: 10.16 mm
- Number of poles: 2-9
- IEC: 1,000 V / 76 A
- UL: 300 V / 60 A

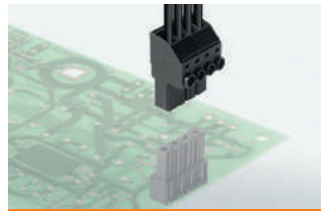

Webcode #01155

#### BUZ 10.16HP

High-performance male plug with 180° outlet direction and high-strength contact system for TNC(S) networks.

- Clamping yoke screw connection
- Pitch: 10.16 mm
- Number of poles: 2-9
- IEC: 1,000 V / 78 A / 0.2-16 mm<sup>2</sup>
- UL: 600 V / 54 A / AWG 24-6



Webcode #01151

#### BUF 10.16HP

High-performance female plug with 180° outlet direction for pole-loss-safe attachment or for use with patented multi-function flanges for TNC(S) networks.

- Clamping yoke screw connection
- Pitch: 10.16 mm
- Number of poles: 2-9
- IEC: 1,000 V / 78 A / 0.2-16 mm<sup>2</sup>
- UL: 600 V / 60 A / AWG 22-4

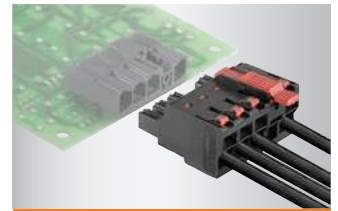

Webcode #11407

#### BVF 10.16IT

High-performance female plug with 180° outlet direction, optionally with multifunction or middle flange for IT power networks.

- PUSH IN spring connection
- 10.16 mm pitch
- Pole count: 2-5
- IEC: 1,000 V / 76 A / 2.5-16 mm<sup>2</sup>

### OMNIMATE® Power HP pitch 16 mm<sup>2</sup>

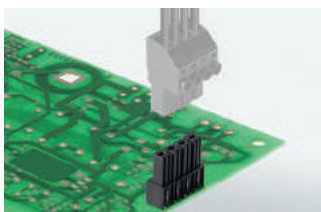

Webcode #01157

#### BUL 10.16HP

High-performance female header with 180° outlet direction and high-strength contact system for TNC(S) networks.

- Female header
- Pitch: 10.16 mm
- Number of poles: 2-4
- IEC: 1,000 V / 76 A
- UL: 300 V / 57 A

## OMNIMATE® Power – Feed-through terminals

### PUSH IN spring connection



Webcode #01159

#### PGK

Device feedthrough terminal blocks with disc design and intuitive locking for a quick and compact solution.

- PUSH IN spring connection
- Connection cross-section: up to 4 mm<sup>2</sup>
- IEC: 500 V / 32 A / 0.5-4 mm<sup>2</sup>
- UL: 300 V / 30 A / AWG 24-10

### Clamping yoke screw connection



Webcode #01161

#### WGK

High-current feed-through terminals as a universal solution to guide currents of various scales through the device wall.

- Clamping yoke screw connection
- Connection cross-section: 6 to 95 mm<sup>2</sup>
- IEC: 1,000 V / 232 A / 0.5-95 mm<sup>2</sup>
- UL: 600 V / 230 A / AWG 24-4/0

### Accessories

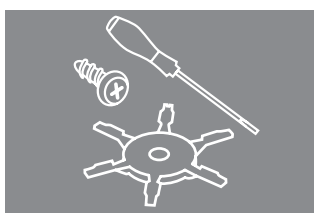

Webcode #11463

#### Accessories

For Power feed-through terminals

**OMNIMATE® Housings**

**CH20M**



**CH20M6**

The tailor-made solution for a wide application spectrum. Fits in any terminal strip.

- Housing width: 6.1 mm
- Connection levels on each side: 4
- Connectable conductors: 8
- Connection technology reflow-compatible: yes
- Circuit board capacity: 1
- Variable circuit board positions: no



**CH20M12**

The "small" option amongst the "large" housing solutions for compact electronics applications.

- Housing width: 12.5 mm
- Connection levels on each side: 3
- Connectable conductors: 12
- Connection technology reflow-compatible: yes
- Circuit board capacity: 1
- Variable circuit board positions: yes



**CH20M17**

Ideal housing solution for compact standard electronics applications.

- Housing width: 17.5 mm
- Connection levels on each side: 3
- Connectable conductors: 18
- Connection technology reflow-compatible: yes
- Circuit board capacity: 1
- Variable circuit board positions: yes



**CH20M22**

Standard format with optimal width for most typical electronics applications.

- Housing width: 22.5 mm
- Connection levels on each side: 3
- Connectable conductors: 24
- Connection technology reflow-compatible: yes
- Circuit board capacity: 1
- Variable circuit board positions: yes

**CH20M**



**CH20M45**

Extra-large size for electronics applications that require more space, such as compact controllers and power supplies.

- Housing width: 45 mm
- Connection levels on each side: 3
- Connectable conductors: 48
- Connection technology reflow-compatible: yes
- Circuit board capacity: 2
- Variable circuit board positions: yes



**CH20M67**

XXL size for those electronics applications that require lots of space, such as compact controllers and power supplies.

- Housing width: 67.5 mm
- Connection levels on each side: 3
- Connectable conductors: 72
- Connection technology reflow-compatible: yes
- Circuit board capacity: 3
- Variable circuit board positions: yes

**Connection system CH20M**



**Connection system CH20M**

PCB terminal or male header and plug-in connectors for the CH20M housing.

- Pitch: 5.00 mm
- Proven connection system
- Misconnection-proof assignment of the connections
- Time and cost saving

**Accessories CH20M**



**Accessories**

for CH20M

**MICROBOX**



**Small enclosure with 6 screw and tension clamp connections**

- Clamping yoke screw connection for conductors up to 2.5 mm<sup>2</sup>
- Tension clamp connection for conductors up to 1.5 mm<sup>2</sup>
- Vibration-resistant contacts
- Vibration-free terminal rail mounting
- Enclosure wall clipped on securely

**TERMINALBOX**

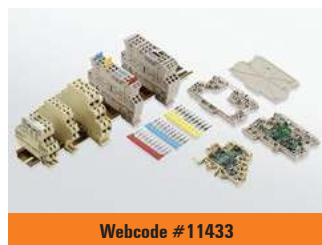

**Small housing with 4 to 6 connection, in screw-connection and tension-clamp versions**

- Versatile arrangements of circuit boards and transparent top plate for clear, permanent labelling
- Cover plates for sealing the enclosure
- Compatible with terminal rails TS32 and TS35

**Modular housings of profile form series RS**



**Modular housings of profile form**

- Pitch profiles with standard widths ranging from 5 mm to 45 mm
- Variable heights
- Different installation variations
- Solid hoods

# Services & products in use

---

<b>Services &amp; products in use</b>	Service	A.2
	AppGuide - Products in use	A.14

---

# Shape design-in processes in a uniquely efficient way

## Our services make sure you get perfect results

They develop connection systems for PCBs and devices based on the final application. Our specialists will gladly provide you with really concrete support with your design-in process, with expertise, advice and a range of useful services.



Our design-in application specialists know your working environment intimately and will support you from the specifications stage right through to series production of your individual solution. Not only will you benefit from our OMNIMATE® services such as the product configurator with 3D models available for download, or the unparalleled 72-hour sample service for your free design-in samples; you'll also have access to a wide range of additional services designed to make your day-to-day work quicker, easier and more professional.



Webcode #01163

### 72-hour sample service

With PCB and device designs, there always comes a point at which design engineers need to find exactly the right connection for their application. Just order your design-in samples, quickly and easily. Make the most of the free 72-hour sample service for OMNIMATE®. Wherever you're situated, we always keep our word and deliver your samples to the desired location within 72 hours.



Webcode #01201

### Webinars on practical issues

Exciting online seminars on relevant issues relating to device connection systems will help you with the practical aspects of your project, from device design to integration into modern drive modules or how to reduced engineering costs. All webinar services are free of charge. You can find out dates, topics and presenters quickly and easily using the corresponding webcode.



Webcode #11359

### Whitepaper

Find out detailed information and interesting facts about trend topics in the field of device connectivity in our Whitepaper section.



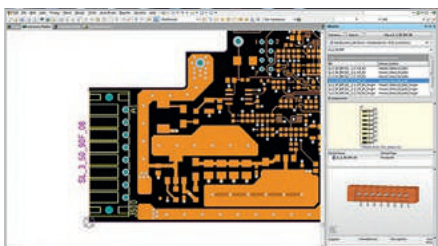

Webcode #01203

### Component library for electronic PCB design

Switching symbols and the painstaking creation of footprints are now things of the past. We offer extensive component libraries of OMNIMATE® PCB terminals and PCB connectors for a wide range of different EDA systems. Simply download and import the data set and you're ready to go.



b2b.partcommunity.com

### CAD models in the Part Community

CAD models for our OMNIMATE® PCB connection systems can be found in one of the industry's most important online forums. The "Part Community" allows engineers and technicians to trade knowledge on technical topics in all fields. The Community's online catalogue contains the exact dimensions and all other relevant data for our products.



Webcode #11347

### Technical information

The OMNIMATE® device connection methodology is highly flexible, ensuring your application requirements are met. The more familiar you are with it, the easier it is to find the optimum component.



### Weidmüller YouTube channel

Did you know? You can find a range of useful handling videos about our products, as well as exciting company insights, on our YouTube channel. Have a look and subscribe to our channel today!



### On-site advice by application specialists

We develop connection systems for PCBs and devices based on the application. And if you can involve us in your development at an early stage – even better. As part of our personal on-site customer consultancy service, our application specialists will meet with your technicians to discuss questions and problems relating to your project, and will assist you with their comprehensive expertise.



# Do you need fast, exclusive, specialist support? Our extensive support is faster than you can imagine.

A

## Your service portfolio

Weidmüller's products and services are designed with one goal in mind: Optimisation.

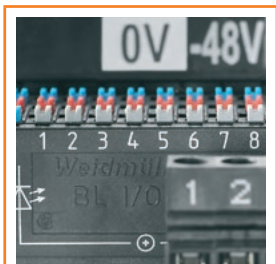

Clear labelling



Distinctive coding

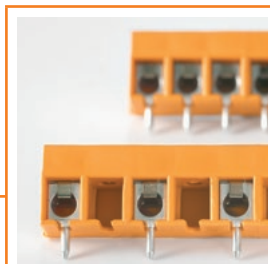

Custom assembly



Process-compatible packaging



Optimised pin lengths



Automated PCB manufacturing compliant



Customised colours



Application-specific developments

## The aim: to match your requirements.



**Comprehensive support network**

The Weidmüller design-in partnership – more than just a contact

**Partnership.  
Powered by  
Weidmüller**

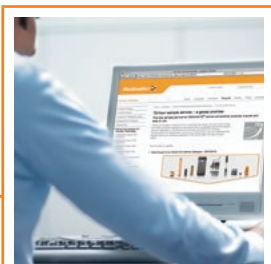

Online product selector and configurator

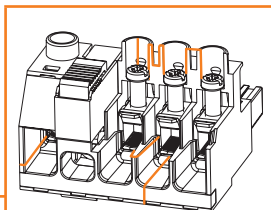

Online 3D CAD/CAE data download



72 h delivery service for prototype samples

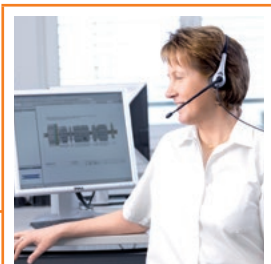

Personal advice that delivers a consistent solutions-oriented approach



Proactive design-in – high level of application expertise

# The new Weidmüller online services

## The intelligent service concept for the design-in process

A

### Design-in at the pace of time

Your entire development process is computer-assisted; you can obtain internal data over the Intranet, or simply go online for your research and communication or to place orders. So why not make the most of new search paths and services independently of the catalogues? It's web-based, making it really simple and saving valuable time.

Weidmüller has fundamentally re-designed the selection and ordering process for device connectivity in a way that better suits your application. In the future, there'll no longer be just the one path to the right product; there'll just be the right path: yours. Let's connect.

## What you'll get from the new web-based service

### Increased range of selection options

Make the most of the full breadth and depth of our product and services range for PCBs and PCB device connectivity without missing a thing.

### Intuitive handling

All of our tools are self-explanatory and are also suitable for beginners.

### Excellent functionality

Discover the range of possibilities offered by practice-oriented tools and special functions, such as the counterpart selector that helps you find the right counterpart straight away.

### Simple navigation

With a clear overview and easy navigation through the different product categories, lists and tables.

### Vast array of options

Whether carrying out a restrictive or an expanded search, simply use the specification method nearest to you.

### Added value

Find exactly the right expertise, the most helpful support and the most reliable service to help you execute your project. 72-hour sample service included!

# Meet the newest member of our team: the webcode

## The hashtag for easy product searching



### What are webcodes?

A hashtag followed by five digits – that's all you need to find out detailed information about the products in our wide-ranging portfolio. Entering the sequence of characters activates certain product groups or an individual product.

#### Where can I find the webcode?

Next to the product, either in this brochure or online.

#### Where do I enter the webcode?

Just enter the code into the search screen on our website. \*)

#### Where will I be directed to once I've entered the webcode?

You'll be taken to the product specifications and technical details, as well as additional info and downloads.

\*) Note: Make sure that the pop-up blocker settings are disabled

# Four paths to the right product

## Our online services as process-optimisation tools

As a leading provider and pioneer in the field of device connectivity, Weidmüller supports the entire design-in process with deep-rooted application expertise and tried-and-tested problem-solving skills. Our intelligent service concept is designed to assist you on the way to a successful PCB and device design.

Our global design-in support provides the perfect connection between products and services, and your task is always the key focus. Take advantage of the benefits that strengthen your processes with one of our three paths to the right product.

There is more than one route to the final layout. Our support concept will assist you in all of your search and selection options.



### The AppGuide

When working with applications, you'll need to find ways of successfully implementing your ideas. Simply select your device application in our AppGuide, and we will recommend a range of products for all the different functions of your device.



### The product configurators

Your layout is ready and you know what components you want to use. Use the product configurator to quickly select device connectivity and housings and to adapt them according to your application's component specifications and requirements.



Find the right services for every step of your device development at:  
**[www.weidmueller.com/omnimate](http://www.weidmueller.com/omnimate)**



[www.weidmueller.com](http://www.weidmueller.com)

**Webcode selection**

For an application, you need certain specifications for certain products. Our new webcode allows you to go directly to the relevant products: simply choose the required product from the following pages and enter the hashtag with five-digit code on our website, and you'll be directed to the relevant details.



<http://catalog.weidmueller.com>

**Specification filters**

In our online catalog in the area of device connectivity, you filter the right product in seconds using your product and application requirements.

# From concept to prototype in just 72 hours

**You prefer to implement your ideas for PCB and device designs directly. We share your passion. Try our unique, on-demand, 72-hour sample service and see how great it is. Let's connect.**

When designing PCBs and devices, development engineers eventually reach the point when they have to find the ideal connectivity components for their applications.

With Weidmüller's sample service, you won't lose any time; within 72 hours, Weidmüller delivers samples of your device connection components and electronics housing to you, wherever you are located.

The path from our sample stock to your designers workplace is simple and begins with Weidmüller's online catalogue. Here, searchers will find 2,500 products in the area of device connectivity and can select up to 25 samples.

Just a click of the mouse on the new "Order sample" button initiates the delivery process – from Weidmüller's warehouse to you, anywhere in the world. Let's connect.

**Available for order online**  
Select your sample directly from the OMNIMATE® online catalogue.  
[www.sample-service.com](http://www.sample-service.com)



**This is how to get your design-in sample:**

Simply go to the Weidmüller online catalogue or **[www.sample-service.com](http://www.sample-service.com)**. Find the ideal OMNIMATE® component there, enter your contact information and send in your order. Done! We'll deliver your design-in sample to any location.



**Let's connect.**

**Best-in-class service**

Our service team is ready to respond to any enquiry. You benefit from our best-in-class customer service.





**Large selection of products**

Choose your samples from more than 2,500 items in the OMNIMATE® product portfolio.



**At your workplace in 72 hours**

You will receive your samples no later than 72 hours after placing the order. Track your samples using your individual tracking number.

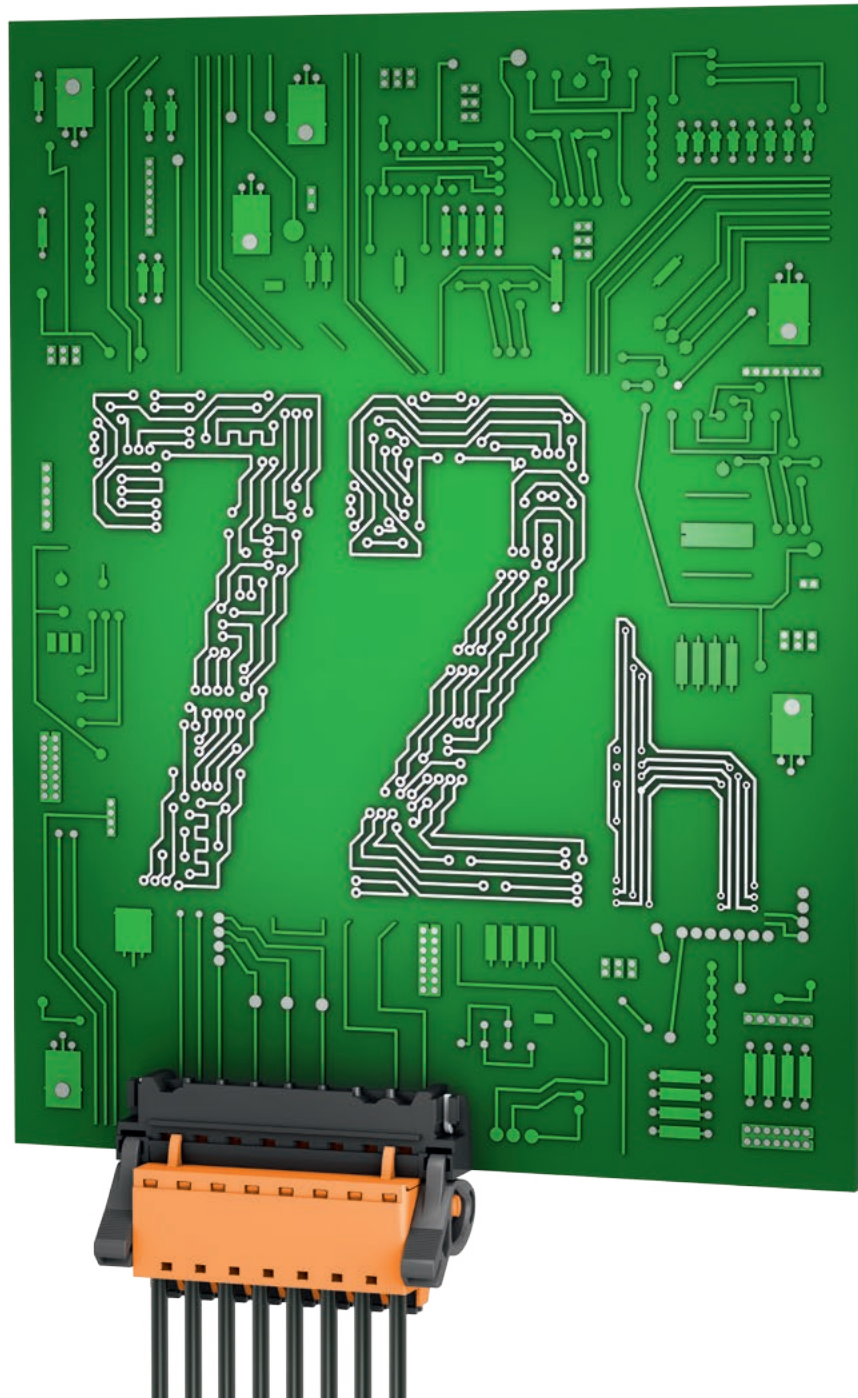

# Your requirements for individual components

## Our product configurators for more design freedom

### Product configurator for device connection technology

Whenever you are looking for the right connection technology, the product configurator for device connection technology enables the quick selection and adaptation of terminals and plug connectors according to component specifications and application requirements.

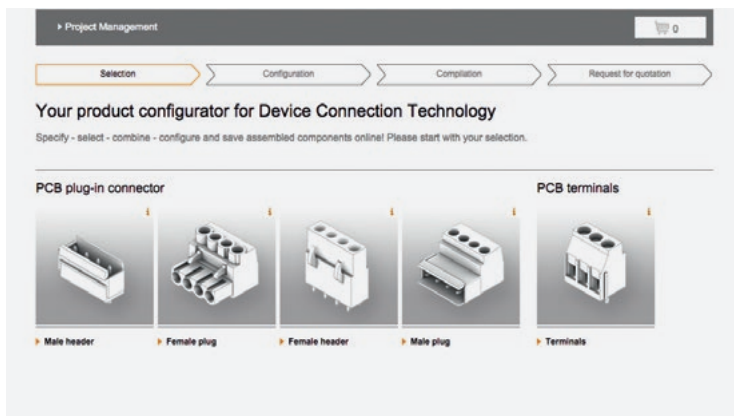

### Stored data packages

- Ordering data
- Dimensions and weights
- System specifications
- Material data
- Connection system data
- Rating and nominal data
- Classifications
- Approvals



Customised colours



Process-compatible packaging

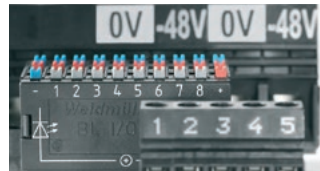

Clear labelling



Application-oriented surfacing systems



Optimised pin lengths



Distinctive coding

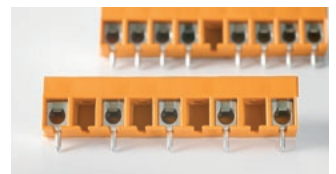

Custom assembly

### Product configurator for electronic housings

Weidmüller's innovative CH20M housing system allows us to provide the best platform to fit your custom requirements – for whatever electronics application you are planning. Configure custom-fit housings according to your requirements from our line of connectivity, housing, and accessory components.

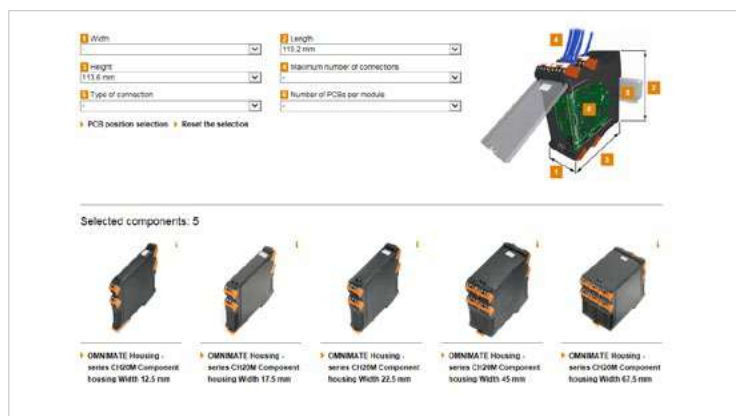

Customised colours



Clear labelling



Custom assembly



Dimensions of the circuit board



User-friendly mounting rail connection

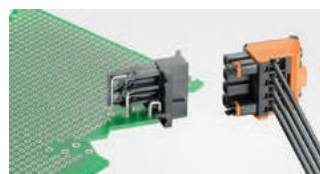

Pin lengths optimized for the process



Process-compatible packaging

## Your device application

### Our AppGuide for device developers

Based on your application, the AppGuide will show you a representative range of products for the different functions of your device.

The overview will show you the application as you know it. Move the cursor over the markings to find out information on the connection technology for sub-assemblies and components. And it's just a few more clicks from here to your desired product.



# AppGuide

## for device developers

Wanted. Found. **Let's connect.**

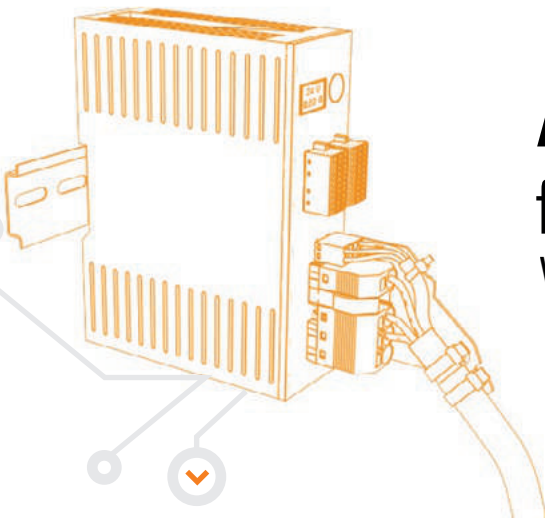

#### 1. Open the AppGuide

Go to:  
[www.weidmueller.com/AppGuide](http://www.weidmueller.com/AppGuide) or use  
the **Webcode #01171**

#### 2. Select the application

Hotspots will show you the way  
to our recommended products

# Go directly to your application with the webcode



Industrial controls  
Webcode #01173



Drive controllers and regulators  
Webcode #01175



Devices of machine safety  
Webcode #01177



Analogue signal converter  
Webcode #01179



Photovoltaic inverter  
Webcode #01181



Power supply  
Webcode #01183



Radio base stations  
Webcode #01187



Heating electronics  
Webcode #01189



Building security equipment  
Webcode #01191



LED lighting systems  
Webcode #01195



Elevator electronics devices  
Webcode #01197

## Webcodes #

Simply enter the hashtag with five digits into the search screen on our website to find out more about your application and the matching products.



### 3. Select product group

Use the hotspots to find the perfect products for your applications



### 4. Receive the product

Configure your selection and use the available functions of our online catalogue.

## An example of the OMNIMATE® Signal device connection method used in an industrial control application.

The trend in industrial automation technology is towards space-saving, cost-effective design. This results in higher density in the controls and individual components. At the same time, cost pressure and the demands of plant safety also increase. Furthermore, standards across all industries have to be complied with and automation know-how must be kept in tip-top shape.

We have been closely monitoring developments in electrical engineering and processing through all their stages and our range of products meets the trends and in many cases anticipates them. One example is our pin headers, which were optimised for the automated assembly and reflow soldering processes in advance. We are specialists in industrial connectivity. With an eye on practical application, we can support you in all your needs for automation and systems technology (measurement, industrial process and control technology), particularly in the areas of sensor actuator interfaces and power supplies.

We think you will be very pleased with our broad spectrum of products, particularly those in the OMNIMATE® family. You have a choice of device connectivity products which you can trust to be perfectly suited to your application needs. Our customer service staff is on hand to advise you in the selection process. In addition, our online configurator, located on our website, can help you put together your own entire product from the comfort of your computer. You can also find a 3D CAD tool for your product development free of charge under our Downloads section online. To round off our service, we offer our unique, on-demand 72-hour sample service, which ensures that you get the sample you request directly on site within three days.

Let's connect.



### Input card

PCB BL-I/O plug-in connectors with PUSH IN connections for the most compact solution



**Power supply & peripherals**

PCB terminals and connectors, in 5.08 pitch, with PUSH IN or screw wire connections

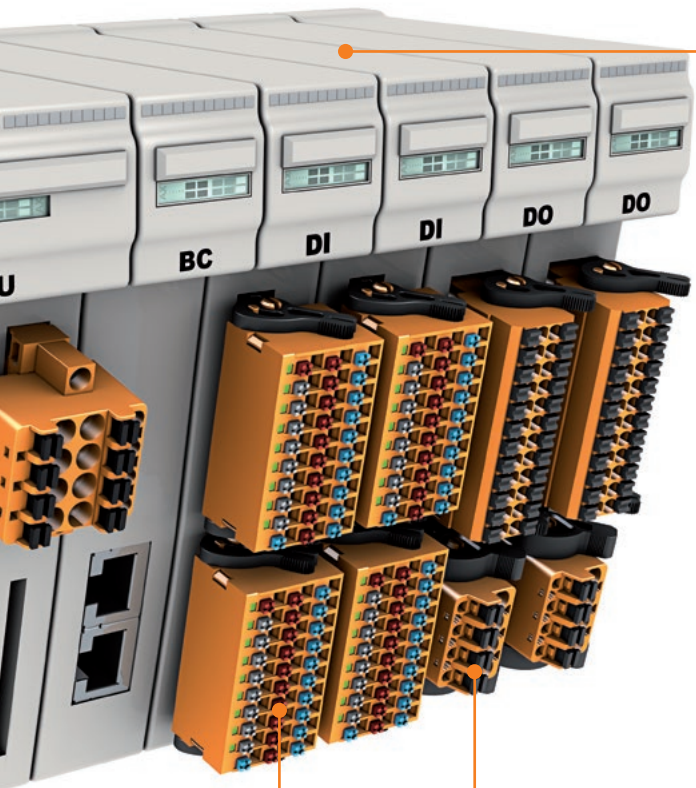

**Housings**

CH20M electronic component housing in module widths of 6 mm to 67.5 mm



**Output card**

Compact B2CF 3.5 mm PCB plug-in connectors in two rows of PUSH IN connection



# An example of the OMNIMATE® Power device connection method in a frequency converter application.

Semiconductor technology for power electronics has progressed at a steady pace in the last few years enabling more complex drive controllers to be manufactured, e.g. for rotational speed controllers or for precise positioning systems. So it's more important than ever to take advantage of connection technology that you can trust now and in the future.

We specialise in industrial connectivity; our connectivity solutions for the power electronics sector are backed by our comprehensive, real-world expertise. We understand the extremely demanding requirements for the servo-controllers and frequency inverters that are common in this business. Voltages of 400 to 690 V (according to IEC) and 600 V (according to UL), and up to 1,000 V in DC circuits, are not uncommon for such equipment. That is why you require high current-carrying capacity implemented in the most compact space possible. We can provide superior connectivity solutions to meet these challenging requirements.

You will be impressed with the vast range of our OMNIMATE® product line. Our OMNIMATE® Signal, OMNIMATE® Power, OMNIMATE® Housings and FieldPower® series offer you a choice range of products and the ideal connectivity solution for your application. We also support you with free 3D CAD files, which can be downloaded from the Weidmüller Online Configurator. In addition our unique, convenient and quick 72-hour OMNIMATE® sample service guarantees your design project stays on schedule. This service is convenient and quick to use – you receive the requested samples within 72 hours.

Let's connect.

### Power supply

High-performance connectors and terminals for circuit boards; terminals for feeding through housing walls



### Motor connections

Convenient and standardised motor connections: hybrid motor plugs, soldered feedthrough terminals and PCB terminals blocks

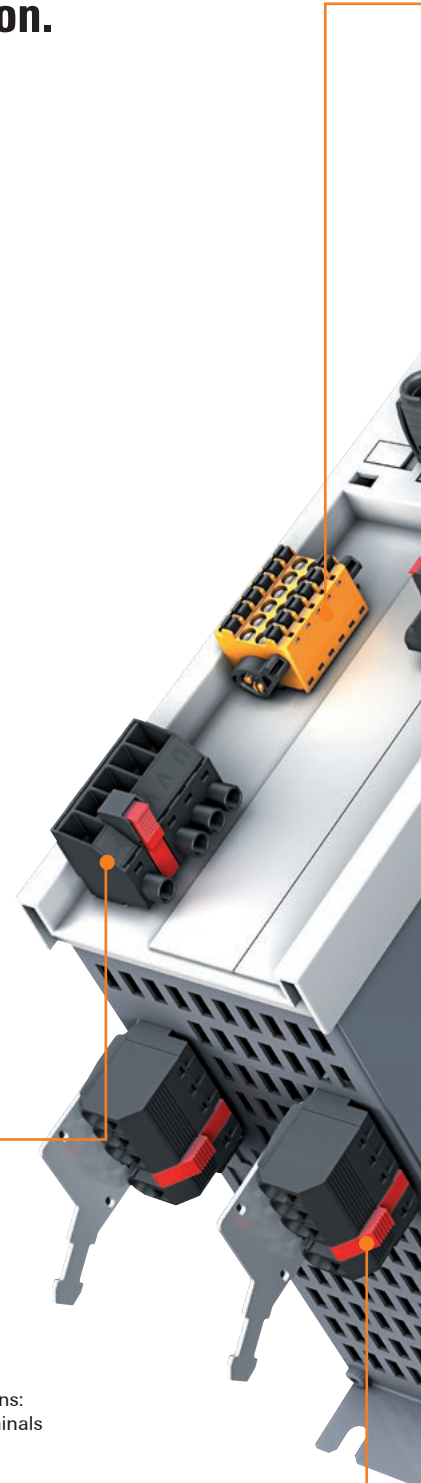



**Safety circuit**

PCB terminals and connectors, in 5.08 pitch, with PUSH IN or screw wire connections



**External I/Os**

Solutions with PUSH IN provide the most compact installation density for I/Os: in single row, triple row and double row



**Intermediate circuits (DC-Link)**

Device feedthrough terminals for direct connections, PCB terminals, connectors carrying high voltages safely

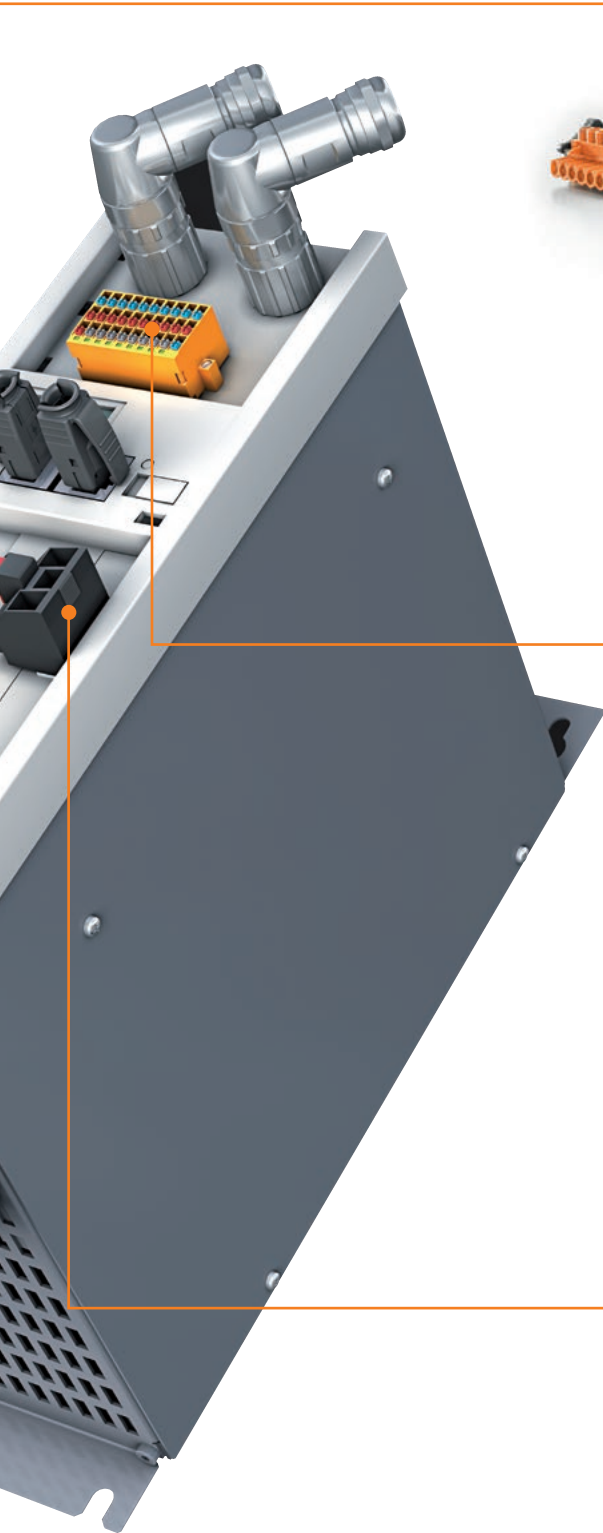

## An example of OMNIMATE® Housings in an analogue signal converter application

Industrial sectors with sensitive requirements need extremely accurate measurements in their applications. These include oil and gas production, chemical, steel and power plants, water-processing and waste disposal plants. Here the job is to define values such as temperature, pressure, fill level, flow volume, weight or speed and then measure them as part of a continuous production process. For maximum accuracy, external influences must be eliminated and measurement values must be transferred within the process chain without any errors – even over long distances.

The best electronic devices ensure that temperature fluctuations, electromagnetic interference, vibration, corrosion and potentially explosive atmospheres do not affect the accuracy of signal transmission and conversion. This level of accuracy can be effectively supported by the use of special electronics housings and reliable connection systems.

At Weidmüller, our designs meet the demands you place on your electronics housings and connection systems. This is due to our expertise and experience in the production of signal converters. With our OMNIMATE® Housing, OMNIMATE® Signal and OMNIMATE® Power product groups, you can select the right connection solution for your application.

Let's connect.

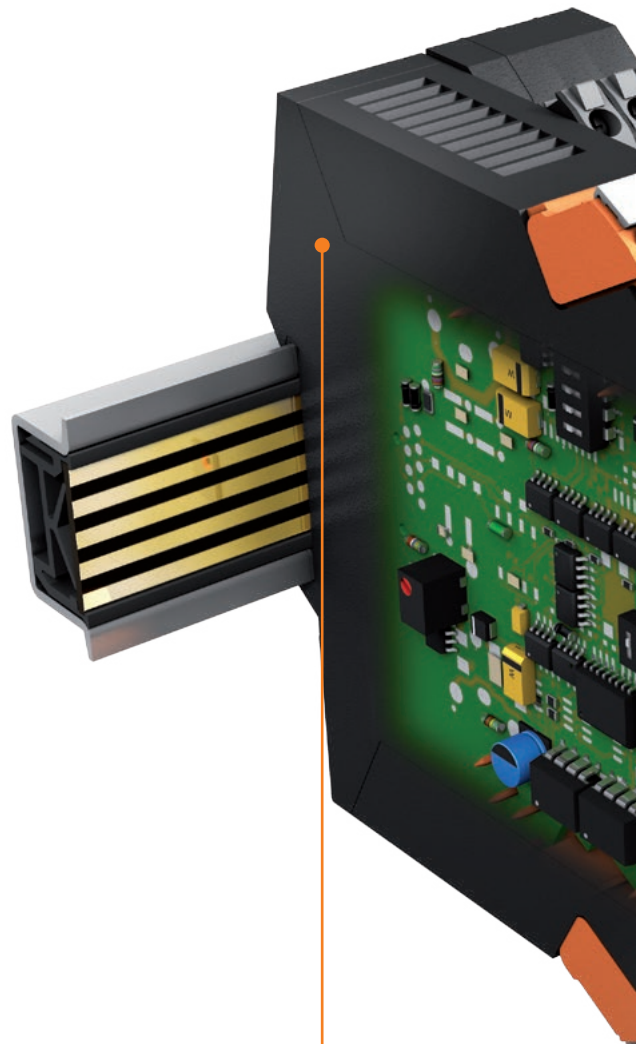

### Housing

CH20M – the new housing standard – the ideal platform for customised electronic applications.



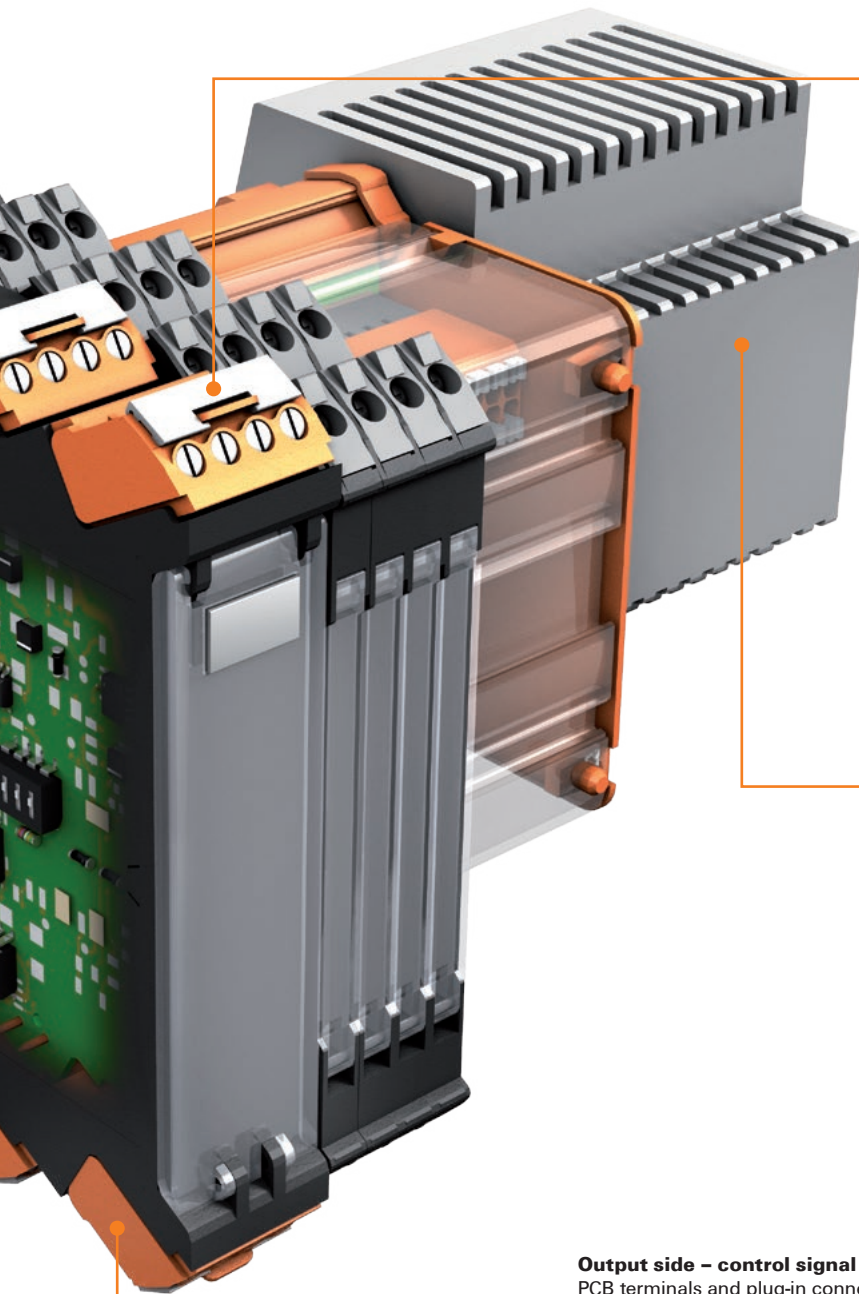

**Input side – signal acquisition**

PCB terminals and plug-in connectors create reliable connections



**Power supply**

Integrated system bus in the TS 35 standard top-hat rail



**Output side – control signal**

PCB terminals and plug-in connectors with PUSH IN or screw connections





# OMNIMATE® Data

<b>OMNIMATE® Data</b>	PCB connectors - OMNIMATE® Data	B.2
	RJ45 modular jacks	B.4
	RJ45 transformer jacks	B.24
	USB jacks	B.42

# Reliable transmission of high-frequency data

## OMNIMATE® data components meet the highest demands

A wide variety of PCB jacks are needed for the data transmission in Industrial Ethernet environment. Trends in technology, like the shift from fieldbus to Industrial Ethernet, demand an increasing number of designs of RJ45 PCB jacks to enable adaptation to individual housing design.

RJ45 components from Weidmüller ensure a reliable transmission with high data rates of up to 1 Gbps and provide sufficient safety reserves. With diverse variants, such as for THT, THR or SMT soldering methods, the PCB sockets are suitable for all common methods of circuit board assembly. The shielded technology also allows its use in products for harsh and electromagnetically noisy environments.



### Process-optimised assembly

Suitable for fully automatic assembly (tape on reel) or assembly by hand (tray).



### Variants for every soldering process

We offer suitable products that allow reliable PCB assembly for each of the technologies, SMT, THT or THR soldering, and for any assembly process.

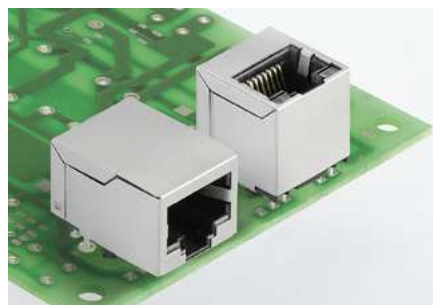



#### Trouble-free assembly

High placement precision due to shorter solder pins (PiP soldering) with chamfered pin tops. In the THR process, this prevents the solder paste from being pressed out of the holes.

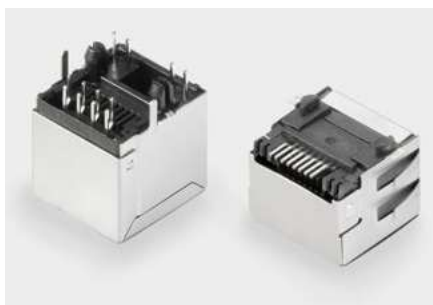

#### Your special advantages

- Weidmüller RJ45 PCB jacks actively counteract noises by integrated "Magnetics", save space on the circuit board and reduce assembly costs
- The reinforced gold layer improves corrosion protection, reduces contact problems and guarantees high durability



Webcode: #11406

<http://www.OMNIMATE.net>

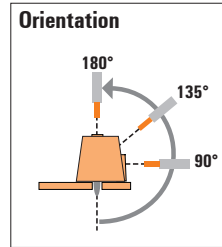

## RJ45 modular jacks

- Shielded
- Contact surface: 30µ" Au
- Temperature range: -40 °C to +85 °C

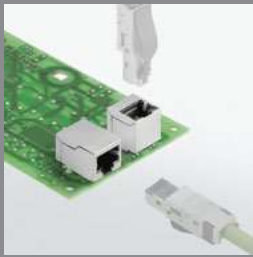

### Mounting onto the PCB



**SMT-soldering process**



**THR-soldering process**



**Wave soldering process**

Reference picture	Outgoing elbow/ Latch option	Shield tabs	LED (left/right)	Performance category
	180° vertical	No	No	Cat.3
		Yes	No	Cat.3
	90° horizontal/latch down	No	No	Cat.3
		No	No	Cat.3
	90° horizontal/latch up	No	No	Cat.3
		Yes	G/Y	Cat.3
		Yes	No	Cat.3
	180° vertical	No	G/Y	Cat.5
		No	No	Cat.5
	90° horizontal/latch down	Yes	G/Y	Cat.5
		Yes	No	Cat.5
	90° horizontal/latch up	Yes	No	Cat.5
		No	G/Y	Cat.5
	180°/vertical	No	No	Cat.6
		No	G/Y	Cat.5
		No	No	Cat.5
		No	No	Cat.5
	90°/latch down	No	No	Cat.5
		Yes	G/Y	Cat.5
		Yes	No	Cat.5
	90°/latch up	No	No	Cat.6
		No	No	Cat.5
		Yes	G/Y	Cat.5
		Yes	No	Cat.5

**Note:**  
 \*1 Solder pin - shield THR  
 \*2 Solder pin - shield SMT  
 \*3 Solder pin - shield front



Packaging	Order No.	Type
Tape	1433900000	RJ45C3 S1V 2.7N4N RL
Tape	2514600000	RJ45C3 S1V 2.7E4N RL
Tape	2000890000	RJ45C3 S1D 2.7N4N RL*1
Tape	1433890000	RJ45C3 S1D 2.7N4N RL*2
Tape	1455220000	RJ45C3 S1U 0.9N4N RL
Tape	2562890000	RJ45C3 S1U DE4G/Y RL
Tape	2562940000	RJ45C3 S1U DE4N RL
Tray	2516380000	RJ45C5 R1V 3.2N4G/Y TY
Tape	2562970000	RJ45C5 R1V 3.2N4N RL
Tape	2562870000	RJ45C5 R1D 3.2E4G/Y RL
Tape	2562910000	RJ45C5 R1D 3.3E4N RL
Tape	2562930000	RJ45C5 R1U 2.8E4N RL
Tape	2562950000	RJ45C5 R1U 2.8N4G/Y RL
Tray	1433920000	RJ45C6 T1V 3.8N4N TY
Tray	2562960000	RJ45C5 T1V 3.2N4G/Y TY
Tray	2436450000	RJ45C5 T1V 4.0N4N TY
Tray	1433810000	RJ45C5 T1V 3.2N4N TY*3
Tray	1433800000	RJ45C5 T1D 3.2N4N TY
Tray	2562820000	RJ45C5 T1D 3.2E4G/Y TY
Tray	2562900000	RJ45C5 T1D 3.3E4N TY
Tray	1433910000	RJ45C6 T1U 2.7N4N TY
Tray	1455240000	RJ45C5 T1U 2.8N4N TY
Tray	2562880000	RJ45C5 T1U 2.8E4G/Y TY
Tray	2562920000	RJ45C5 T1U 2.8E4N TY

RJ45 G1 R1U 3.2E4 GY/GY TY RJ45G1 R1U 3.2E4GY/GY TY

<b>Packaging</b>	<b>TY</b> RL	Tray in box (manual assembly) Tape on Reel (automated assembly)
<b>LED</b>	Y/G G/Y GY/GY O/G R/O ... N	Yellow/Green Green/Yellow (standard) Green-Yellow/Green-Yellow Orange/Green Red/Orange ... (further combinations possible) without LED
<b>Contact surface thickness</b>	4	1 = 3µm, 2 = 6µm, 3 = 15µm, 4 = 30µm, 5 = 50µm
<b>EMI tabs (ground fingers)</b>	E N	E = with EMI tabs N = without EMI tabs
<b>Solder Pin length</b>	3.2 1.6 D	3.2 mm 1.6 mm SMD
<b>Direction, latch style</b>	U D V Y	Horizontal (90°, side entry), latch up Horizontal (90°, side entry), latch down Vertical (180°, top entry) Diagonal (45°), latch up
<b>Number of Ports</b>	1 12; 14; ... 21; 41; ...	1 Port multi ports side by side, Multiport multi ports about each other, Multilevel
<b>Assembly on PCB</b>	R S T	Through Hole Reflow - THR Soldering process: Wave or Reflow soldering Surface Mount Technology - SMT Soldering process: Reflow soldering Through Hole Technology - THT Soldering process: Wave
<b>Performance Category</b>	C5 C6 C6A C5e M G1 G10 U MP MP+	Category 5 Category 6 Category 6A Category 5e 10/100 Mbit 10/100/1000 Mbit 10 Gbit Unshielded 10/100 Mbit with POE 10/100 Mbit with POE+

**RJ45 modular jacks  
for SMT soldering process**

**1x1 port, 180° (vertical)**

For additional articles and information, refer to [catalog.weidmuller.com](http://catalog.weidmuller.com)



OMNIMATE® Data

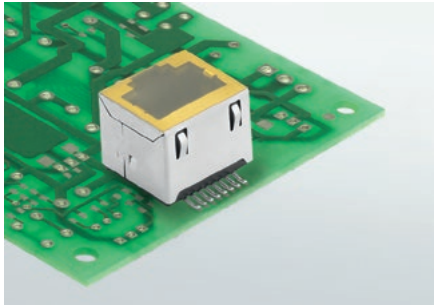

- 360° shielding
- Contact surface 30µ" (0.76µm) Au
- ≥750 plugging cycles
- Extended temperature range: -40 °C to +85 °C
- For fully automatic assembly (tape-on-reel)
- Optimised package sizes
- Other variations on request

B

**Technical data**

Outgoing elbow	180°
Pitch	1.27 mm
Type of insulation material	PA 9T
Colour	Black
UL 94 flammability rating	V-0
Moisture Level (MSL)	1
Shielding material	Copper alloy
Shield surface	nickel-plated
Contact base material	Phosphorus bronze
<b>Note</b>	

Layer structure of plug contact	30-80 µ" Ni / 30-µ" Au
Operating temperature	-40...85 °C
Rated voltage	125 V AC
Rated current	1.5 A
Dielectric strength, contact / contact	≥ 1000 V DC
Insulation resistance	> 500 MΩ
Plugging cycles	750
Approvals	CURUS
Pin dimensions = d	

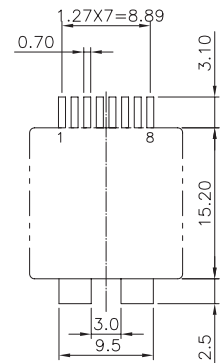
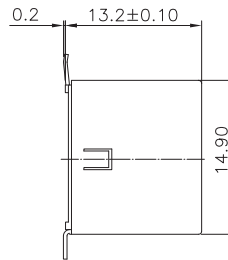
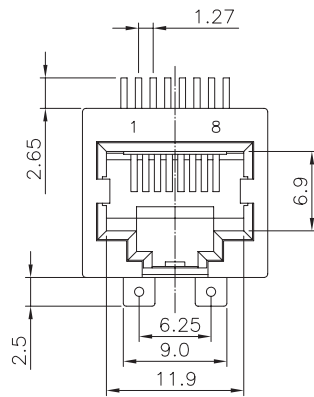

PCB LAYOUT

**Ordering data**

Type	Mounting onto the PCB	Latch option	Shield tabs	LED	Performance-Category	Packaging	Qty.	Order No.
RJ45C3 S1V 2.7N4N RL	SMD solder connection		none	No	Cat.3	Tape	300	1433900000
Other versions on request								



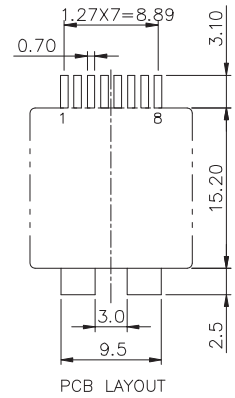
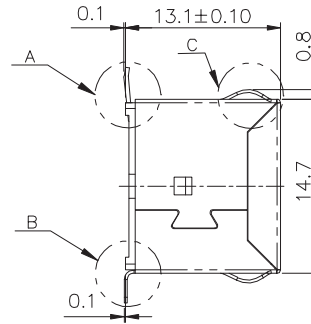
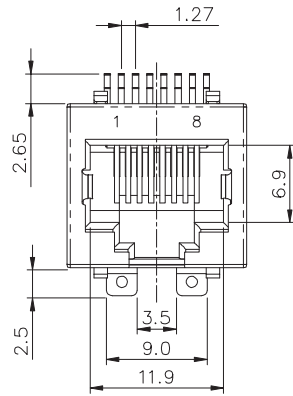

PCB LAYOUT

**Ordering data**

Type	Mounting onto the PCB	Latch option	Shield tabs	LED	Performance-Category	Packaging	Qty.	Order No.
RJ45C3 S1V 2.7E4N RL	SMD solder connection		4 tabs	No	Cat.3	Tape	300	251460000

**RJ45 modular jacks  
for SMT soldering process**

**1x1 port, 90° (horizontal) latch down**

For additional articles and information, refer to [catalog.weidmuller.com](http://catalog.weidmuller.com)



OMNIMATE® Data

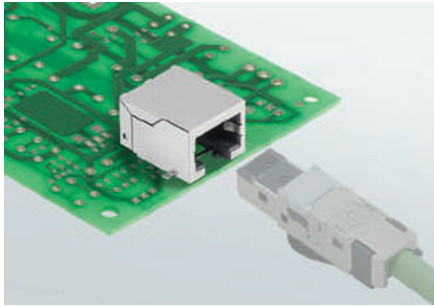

- 360° shielding
- Contact surface 30µ" (0.76µm) Au
- ≥750 plugging cycles
- Extended temperature range: -40 °C to +85 °C
- For fully automatic assembly (tape-on-reel)
- Optimised package sizes
- Other variations on request

B

**Technical data**

Outgoing elbow	90°
Pitch	1.27 mm
Type of insulation material	PA 9T
Colour	Black
UL 94 flammability rating	V-0
Moisture Level (MSL)	1
Shielding material	Copper alloy
Shield surface	nickel-plated
Contact base material	Phosphorus bronze
<b>Note</b>	

Layer structure of plug contact	30-80 µ" Ni / 30-µ" Au
Operating temperature	-40...85 °C
Rated voltage	125 V AC
Rated current	1.5 A
Dielectric strength, contact / contact	≥ 1000 V DC
Insulation resistance	> 500 MΩ
Plugging cycles	750
Approvals	CURUS
Pin dimensions = d	

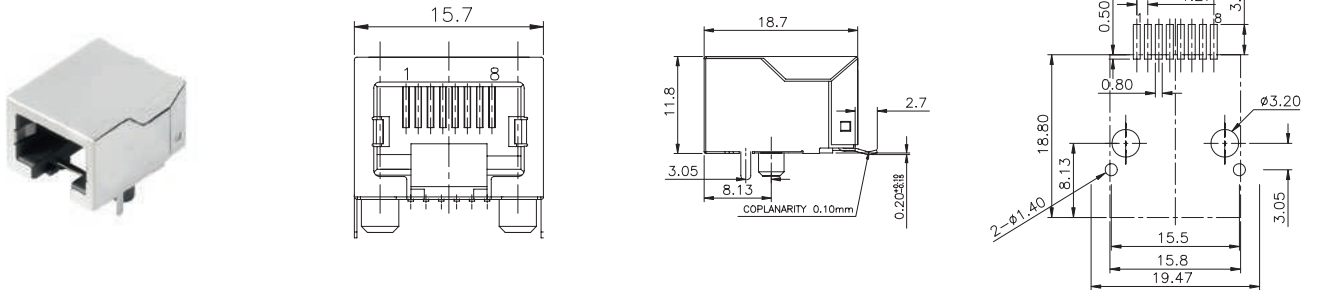

**Ordering data**

Type	Mounting onto the PCB	Latch option	Shield tabs	LED	Performance-Category	Packaging	Qty.	Order No.
RJ45C3 S1D 2.7N4N RL	SMD solder connection	bottom	none	No	Cat.3	Tape	240	<b>2000890000</b>

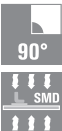

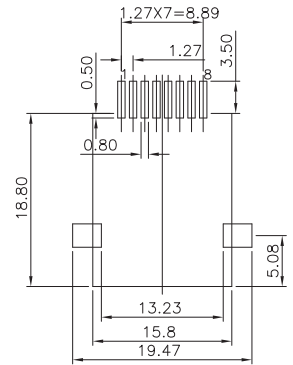
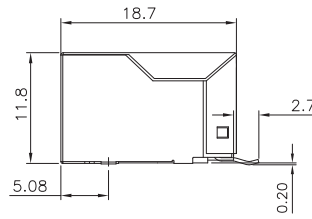
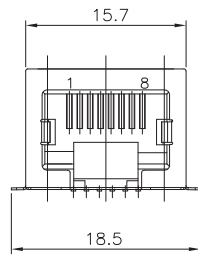

PCB LAYOUT

### Ordering data

Type	Mounting onto the PCB	Latch option	Shield tabs	LED	Performance-Category	Packaging	Qty.	Order No.
RJ45C3 S1D 2.7N4N RL	SMD solder connection	bottom	none	No	Cat.3	Tape	300	1433890000
Other versions on request								

**RJ45 modular jacks  
for SMT soldering process**

**1x1 port, 90° (horizontal) latch up**

For additional articles and information, refer to [catalog.weidmuller.com](http://catalog.weidmuller.com)



OMNIMATE® Data

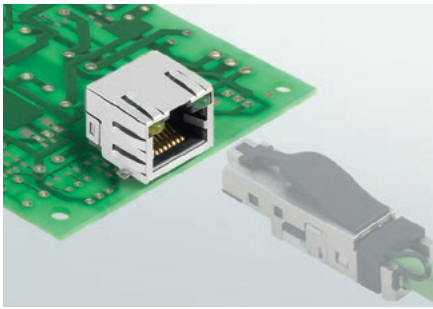

- 360° shielding
- Contact surface 30µ" (0.76µm) Au
- ≥750 plugging cycles
- Extended temperature range: -40 °C to +85 °C
- For fully automatic assembly (tape-on-reel)
- Optimised package sizes
- Other variations on request

B

**Technical data**

Outgoing elbow	90°
Pitch	1.27 mm
Type of insulation material	PA 9T
Colour	Black
UL 94 flammability rating	V-0
Moisture Level (MSL)	1
Shielding material	Copper alloy
Shield surface	nickel-plated
Contact base material	Phosphorus bronze
<b>Note</b>	

Layer structure of plug contact	30-80 µ" Ni / 30-µ" Au
Operating temperature	-40...85 °C
Rated voltage	125 V AC
Rated current	1.5 A
Dielectric strength, contact / contact	≥ 1000 V DC
Insulation resistance	> 500 MΩ
Plugging cycles	750
Approvals	CURUS
Pin dimensions = d	

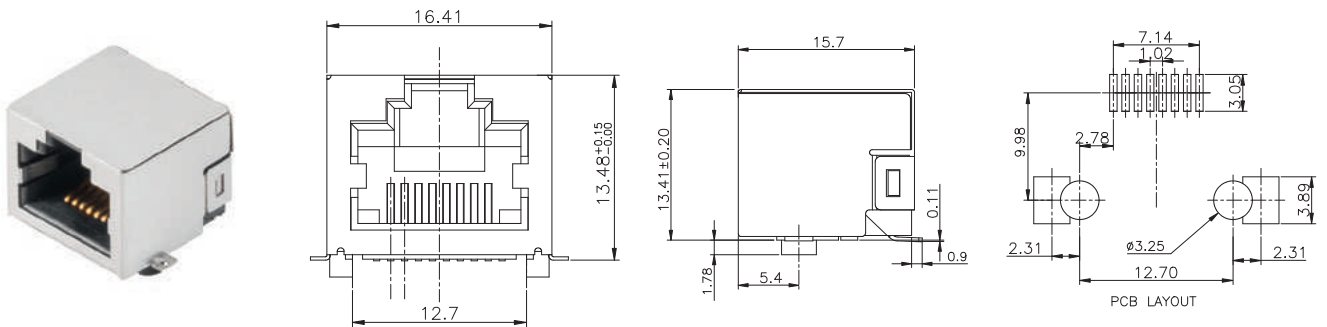

**Ordering data**

Type	Mounting onto the PCB	Latch option	Shield tabs	LED	Performance-Category	Packaging	Qty.	Order No.
RJ45C3 S1U 0.9N4N RL	SMD solder connection	top	none	No	Cat.3	Tape	200	1455220000

Other versions on request

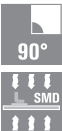

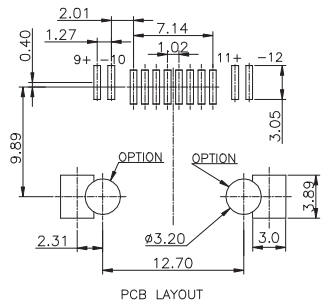
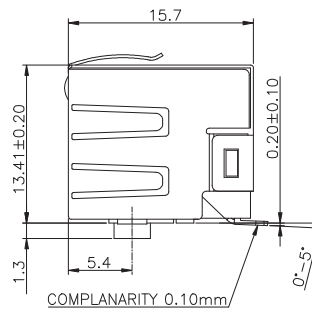
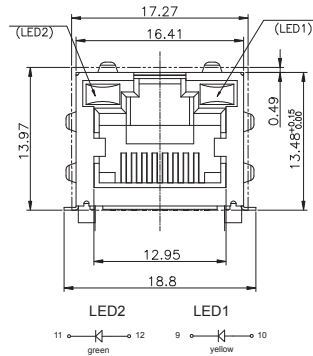

### Ordering data

Type	Mounting onto the PCB	Latch option	Shield tabs	LED	Performance-Category	Packaging	Qty.	Order No.
RJ45C3 S1U DE4G/Y RL	SMD solder connection	top	6 tabs	Yes	Cat.3	Tape	200	2562890000

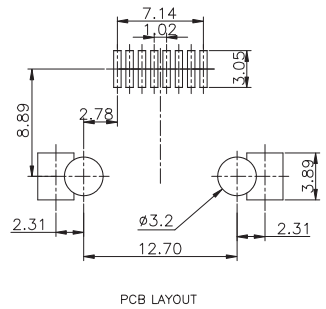
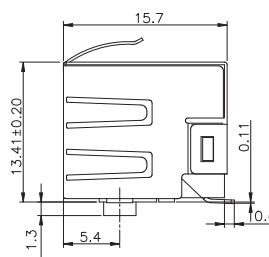
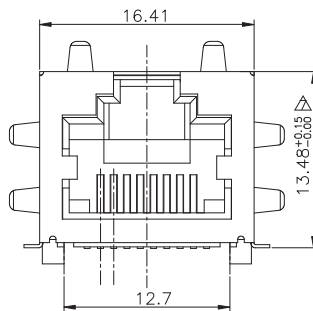

### Ordering data

Type	Mounting onto the PCB	Latch option	Shield tabs	LED	Performance-Category	Packaging	Qty.	Order No.
RJ45C3 S1U DE4N RL	SMD solder connection	top	6 tabs	No	Cat.3	Tape	200	2562940000

**RJ45 modular jacks  
for THR soldering process**

**1x1 port, 180° (vertical)**

For additional articles and information, refer to [catalog.weidmuller.com](http://catalog.weidmuller.com)



- 360° shielding
- Contact surface 30µ" (0.76µm) Au
- ≥750 plugging cycles
- Extended temperature range: -40 °C to +85 °C
- For fully automated assembly (tape-on-reel) or manual assembly (tray)
- Optimised package sizes
- Other variations on request

**Technical data**

Outgoing elbow	180°
Pitch	1.27 mm
Type of insulation material	PA 9T
Colour	Black
UL 94 flammability rating	V-0
Moisture Level (MSL)	1
Shielding material	Brass
Shield surface	nickel-plated
Contact base material	Phosphorus bronze
<b>Note</b>	

Layer structure of plug contact	30-80 µ" Ni / 30-µ" Au
Operating temperature	-40...85 °C
Rated voltage	125 V AC
Rated current	1.5 A
Dielectric strength, contact / contact	1500 V DC
Insulation resistance	1000 MΩ at 500 V DC
Plugging cycles	750
Approvals	CURUS
Pin dimensions = d	

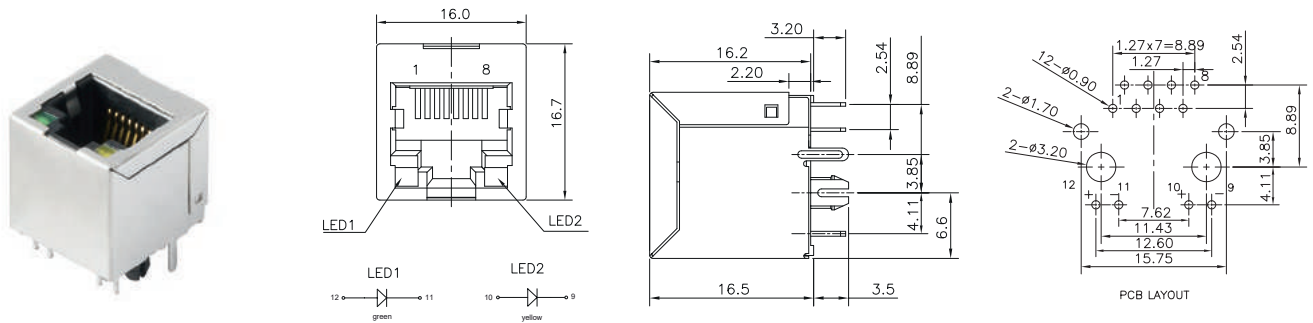

**Ordering data**

Type	Mounting onto the PCB	Latch option	Shield tabs	LED	Performance-Category	Packaging	Qty.	Order No.
RJ45C5 R1V 3.2N4G/Y TY	THT/THR solder connection		none	Yes	Cat. 5	Tray	120	<b>2516380000</b>

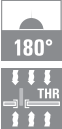



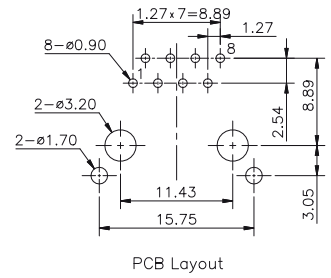
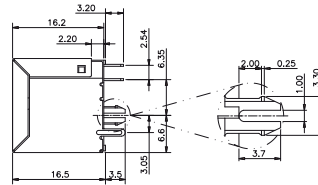
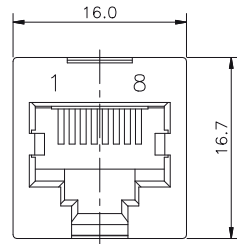

### Ordering data

Type	Mounting onto the PCB	Latch option	Shield tabs	LED	Performance-Category	Packaging	Qty.	Order No.
RJ45C5 R1V 3.2N4N RL	THT/THR solder connection		none	No	Cat. 5	Tape	200	2562970000

**RJ45 modular jacks  
for THR soldering process**

OMNIMATE® Data

B

**1x1 port, 90° (horizontal) latch down**

For additional articles and information, refer to [catalog.weidmueller.com](http://catalog.weidmueller.com)

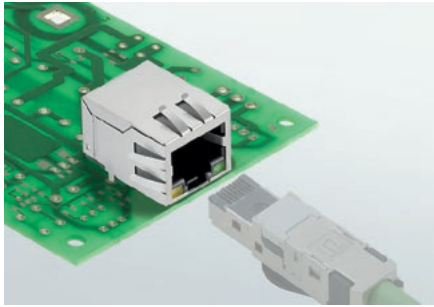

- 360° shielding
- Contact surface 30µ" (0.76µm) Au
- ≥750 plugging cycles
- Extended temperature range: -40 °C to +85 °C
- For fully automated assembly (tape-on-reel) or manual assembly (tray)
- Optimised package sizes
- Other variations on request

**Technical data**

Outgoing elbow	90°
Pitch	1.27 mm
Type of insulation material	PA 9T
Colour	Black
UL 94 flammability rating	V-0
Moisture Level (MSL)	1
Shielding material	Brass
Shield surface	nickel-plated
Contact base material	Phosphorus bronze
<b>Note</b>	

Layer structure of plug contact	30-80 µ" Ni / 30-µ" Au
Operating temperature	-40...85 °C
Rated voltage	125 V AC
Rated current	1.5 A
Dielectric strength, contact / contact	1000 V AC
Insulation resistance	1000 MΩ at 500 V DC
Plugging cycles	750
Approvals	CURUS
Pin dimensions = d	

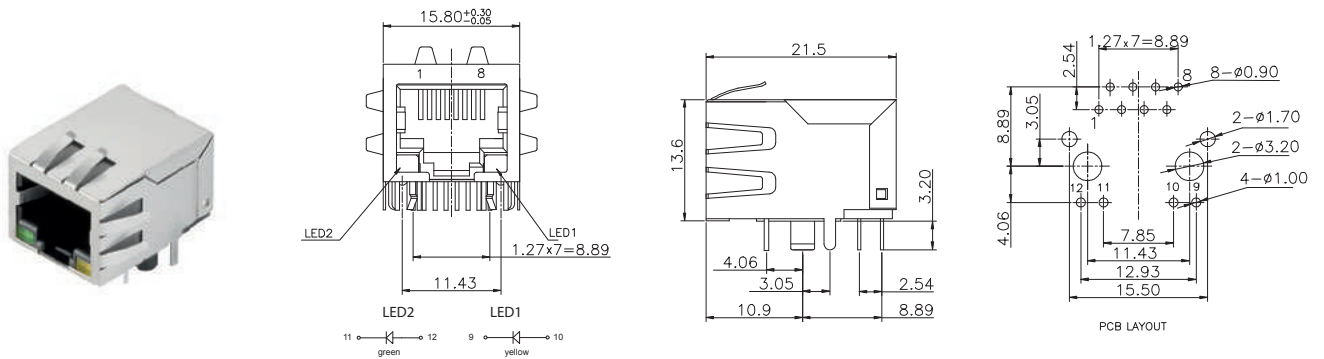

**Ordering data**

Type	Mounting onto the PCB	Latch option	Shield tabs	LED	Performance-Category	Packaging	Qty.	Order No.
RJ45C5 R1D 3.2E4G/Y RL	THT/THR solder connection	bottom	6 tabs	Yes	Cat. 5	Tape	200	<b>2562870000</b>

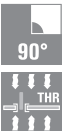

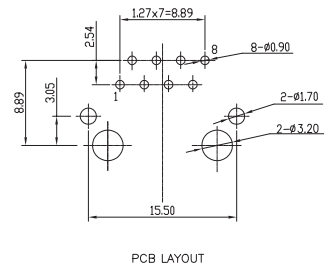
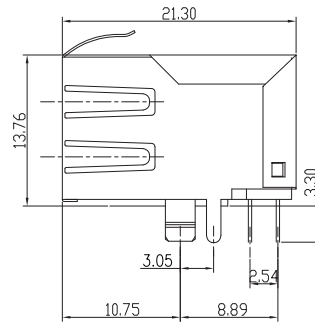
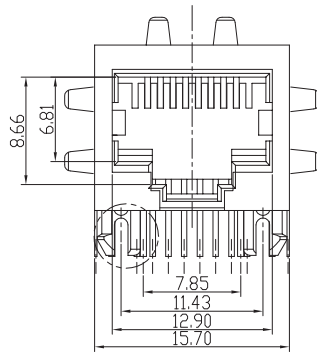

### Ordering data

Type	Mounting onto the PCB	Latch option	Shield tabs	LED	Performance-Category	Packaging	Qty.	Order No.
RJ45C5 R1D 3.3E4N RL	THT/THR solder connection	bottom	6 tabs	No	Cat. 5	Tape	200	2562910000

## RJ45 modular jacks for THR soldering process

### 1x1 port, 90° (horizontal) latch up

For additional articles and information, refer to  
catalog.weidmüller.com

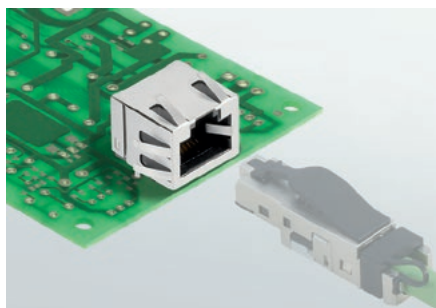

- 360° shielding
- Contact surface 30µ" (0.76µm) Au
- ≥750 plugging cycles
- Extended temperature range: -40 °C to +85 °C
- For fully automated assembly (tape-on-reel) or manual assembly (tray)
- Optimised package sizes
- Other variations on request

#### Technical data

Outgoing elbow	90°
Pitch	1.27 mm
Type of insulation material	PA 9T
Colour	Black
UL 94 flammability rating	V-0
Moisture Level (MSL)	1
Shielding material	Brass
Shield surface	nickel-plated
Contact base material	Phosphorus bronze
<b>Note</b>	

Layer structure of plug contact	30-80 µ" Ni / 30-µ" Au
Operating temperature	-40...85 °C
Rated voltage	125 V AC
Rated current	1.5 A
Dielectric strength, contact / contact	1000 V AC
Insulation resistance	1000 MΩ at 500 V DC
Plugging cycles	750
Approvals	CURUS
Pin dimensions = d	

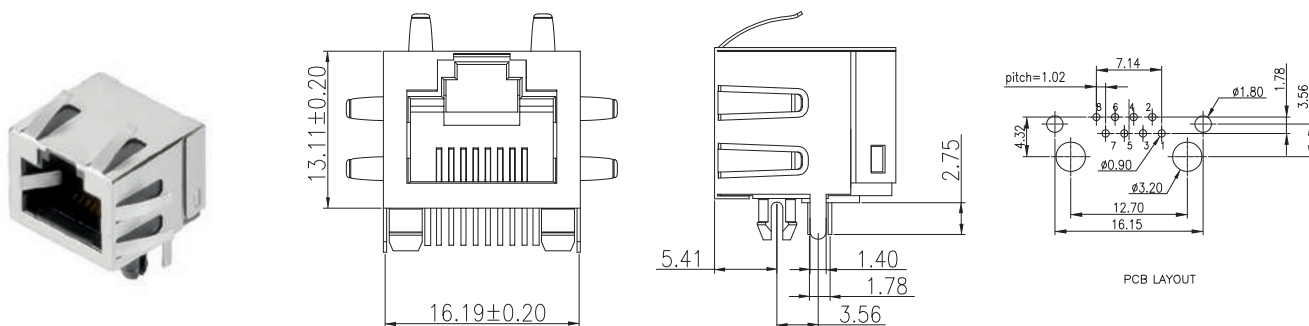

#### Ordering data

Type	Mounting onto the PCB	Latch option	Shield tabs	LED	Performance-Category	Packaging	Qty.	Order No.
RJ45C5 R1U 2.8E4N RL	THT/THR solder connection	bottom	6 tabs	No	Cat. 5	Tape	200	2562930000



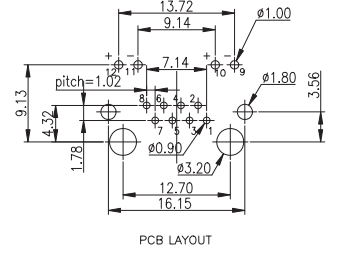
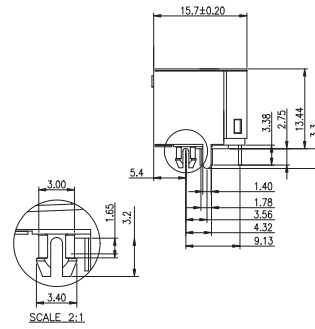
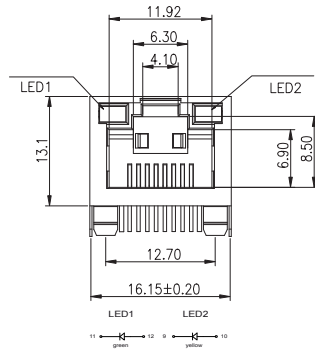

### Ordering data

Type	Mounting onto the PCB	Latch option	Shield tabs	LED	Performance-Category	Packaging	Qty.	Order No.
RJ45C5 R1U 2.8N4G/Y RL	THT/THR solder connection	top	none	Yes	Cat. 5	Tape	200	2562950000

**RJ45 modular jacks  
for wave soldering process**

**1x1 port, 180° (vertical)**

For additional articles and information, refer to [catalog.weidmueller.com](http://catalog.weidmueller.com)



OMNIMATE® Data

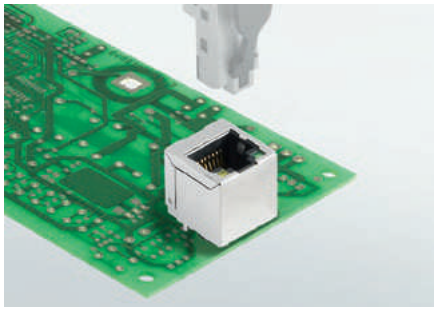

- 360° shielding
- Contact surface 30µ" (0.76µm) Au
- ≥750 plugging cycles
- Extended temperature range: -40 °C to +85 °C
- For manual assembly
- Optimised package sizes
- Other variations on request

B

**Technical data**

Outgoing elbow	180°
Pitch	1.27 mm
Type of insulation material	PA 66
Colour	Black
UL 94 flammability rating	V-0
Shielding material	Copper alloy
Shield surface	nickel-plated
Contact base material	Phosphorus bronze
<b>Note</b>	

Layer structure of plug contact	30-80 µ" Ni / 30-µ" Au
Operating temperature	-40...85 °C
Rated voltage	125 V AC
Rated current	1.5 A
Dielectric strength, contact / contact	≥ 1000 V DC
Insulation resistance	1000 MΩ at 500 V DC
Plugging cycles	750
Approvals	CURUS
Pin dimensions = d	0.40 x 0.30 mm

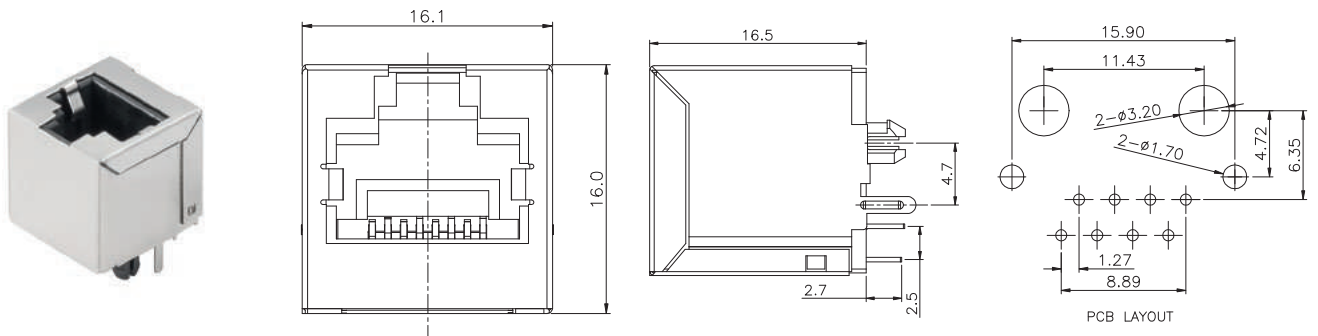

**Ordering data**

Type	Mounting onto the PCB	Latch option	Shield tabs	LED	Performance-Category	Packaging	Qty.	Order No.
RJ45C6 T1V 3.8N4N TY	THT solder connection		none	No	Cat. 6	Tray	160	1433920000
Other versions on request								



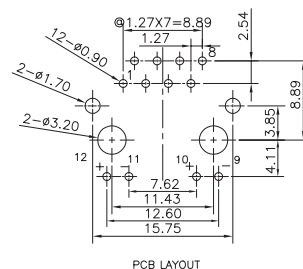
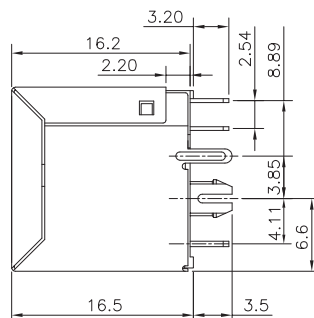
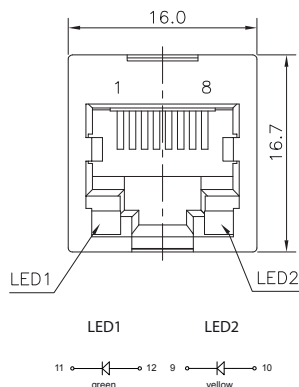

Ordering data

Type	Mounting onto the PCB	Latch option	Shield tabs	LED	Performance-Category	Packaging	Qty.	Order No.
RJ45C5 T1V 3.2N4G/Y TY	THT solder connection		none	Yes	Cat. 5	Tray (manual assembly)	120	2562960000

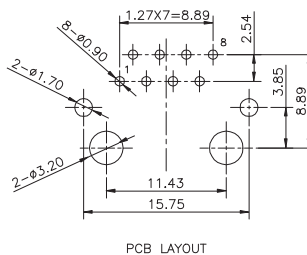
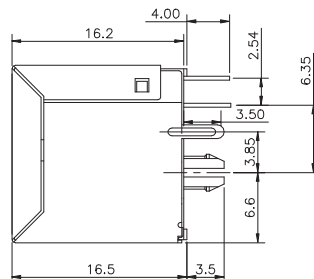
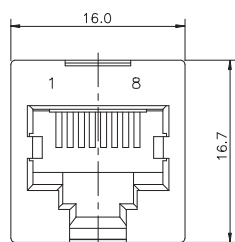

Ordering data

Type	Mounting onto the PCB	Latch option	Shield tabs	LED	Performance-Category	Packaging	Qty.	Order No.
RJ45C5 T1V 3.2N4N TY	THT solder connection		none	No	Cat. 5	Tray (manual assembly)	120	2436450000

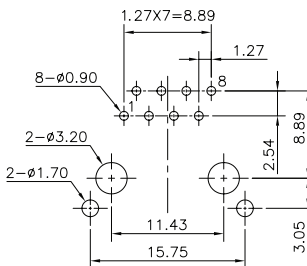
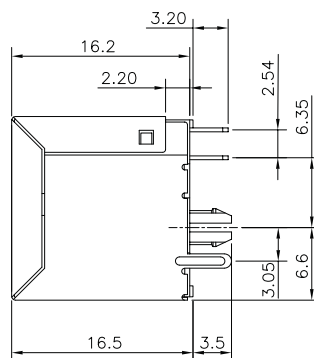
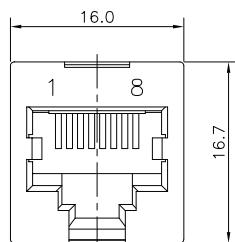

Ordering data

Type	Mounting onto the PCB	Latch option	Shield tabs	LED	Performance-Category	Packaging	Qty.	Order No.
RJ45C5 T1V 3.2N4N TY	THT solder connection		none	No	Cat. 5	Tray	120	1433810000

Other versions on request

**RJ45 modular jacks  
for wave soldering process**

OMNIMATE® Data

B

**1x1 port, 90° (horizontal) latch down**

For additional articles and information, refer to [catalog.weidmueller.com](http://catalog.weidmueller.com)

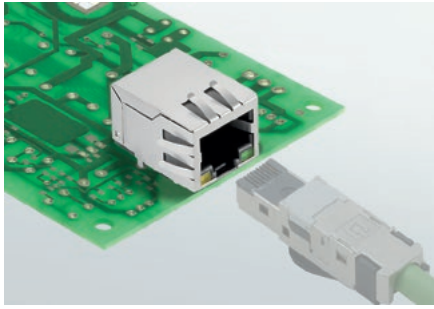

- 360° shielding
- Contact surface 30µ" (0.76µm) Au
- ≥750 plugging cycles
- Extended temperature range: -40 °C to +85 °C
- For manual assembly
- Optimised package sizes
- Other variations on request

**Technical data**

Outgoing elbow	90°
Pitch	1.27 mm
Type of insulation material	PA 66
Colour	Black
UL 94 flammability rating	V-0
Shielding material	Copper alloy
Shield surface	nickel-plated
Contact base material	Phosphorus bronze
<b>Note</b>	

Layer structure of plug contact	30-80 µ" Ni / 30-µ" Au
Operating temperature	-40...85 °C
Rated voltage	125 V AC
Rated current	1.5 A
Dielectric strength, contact / contact	≥ 1000 V DC
Insulation resistance	> 500 MΩ
Plugging cycles	750
Approvals	CURUS
Pin dimensions = d	0.40 x 0.30 mm

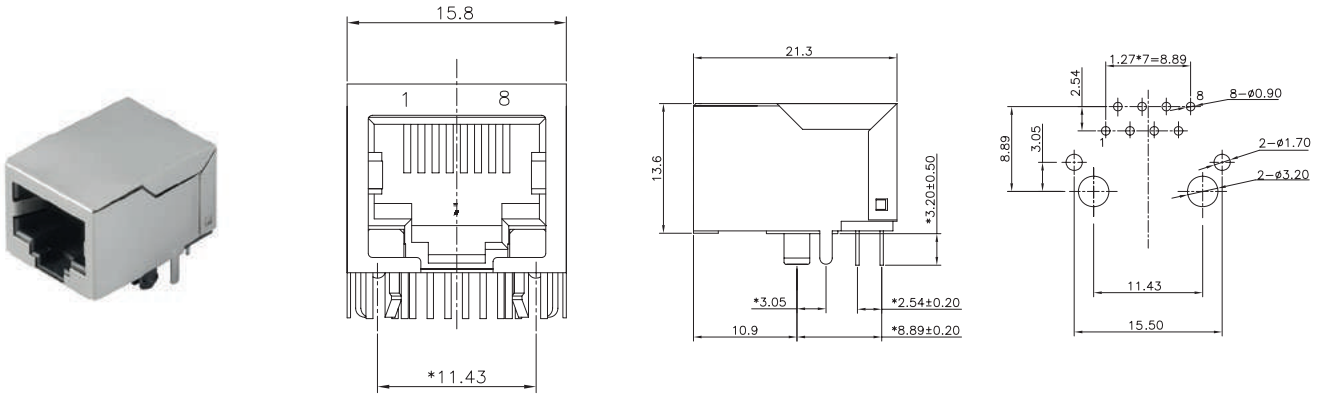

**Ordering data**

Type	Mounting onto the PCB	Latch option	Shield tabs	LED	Performance-Category	Packaging	Qty.	Order No.
RJ45C5 T1D 3.2N4N TY	THT solder connection	bottom	none	No	Cat. 5	Tray	120	1433800000
Other versions on request								





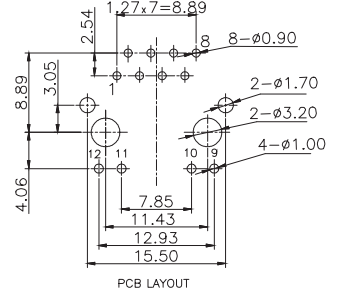
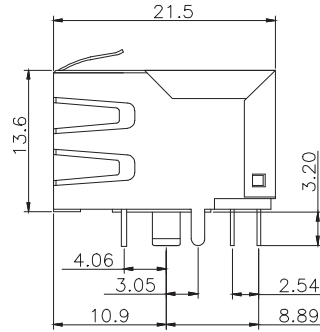
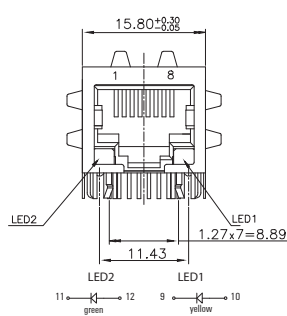

### Ordering data

Type	Mounting onto the PCB	Latch option	Shield tabs	LED	Performance-Category	Packaging	Qty.	Order No.
RJ45C5 T1D 3.2E4G/Y TY	THT solder connection	bottom	6 tabs	Yes	Cat. 5	Tray (manual assembly)	140	2562820000

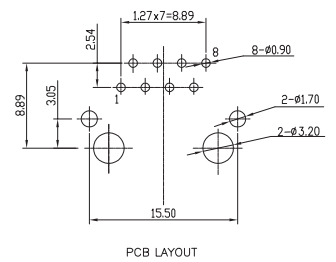
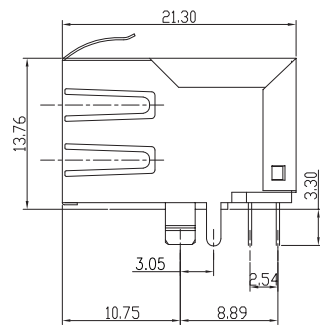
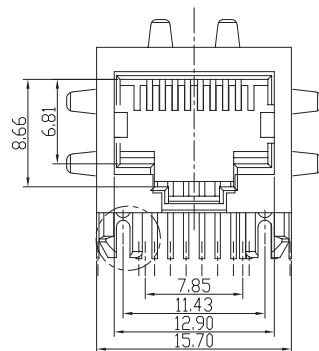

### Ordering data

Type	Mounting onto the PCB	Latch option	Shield tabs	LED	Performance-Category	Packaging	Qty.	Order No.
RJ45C5 T1D 3.3E4N TY	THT solder connection	bottom	6 tabs	No	Cat. 5	Tray (manual assembly)	120	2562900000

**RJ45 modular jacks  
for wave soldering process**

**1x1 port, 90° (horizontal) latch up**

For additional articles and information, refer to [catalog.weidmueller.com](http://catalog.weidmueller.com)



OMNIMATE® Data

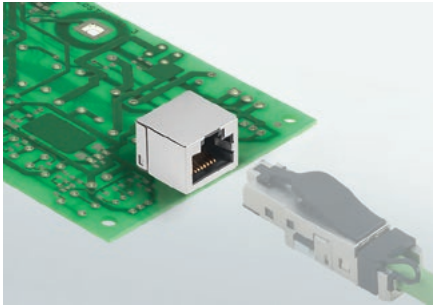

- 360° shielding
- Contact surface 30µ" (0.76µm) Au
- ≥750 plugging cycles
- Extended temperature range: -40 °C to +85 °C
- For manual assembly
- Optimised package sizes
- Other variations on request

B

**Technical data**

Outgoing elbow	90°
Pitch	1.27 mm
Type of insulation material	PA 66
Colour	Black
UL 94 flammability rating	V-0
Shielding material	Copper alloy
Shield surface	nickel-plated
Contact base material	Phosphorus bronze

Layer structure of plug contact	30-80 µ" Ni / 30-µ" Au
Operating temperature	-40...85 °C
Rated voltage	125 V AC
Rated current	1.5 A
Dielectric strength, contact / contact	≥ 1000 V DC
Insulation resistance	1000 MΩ at 500 V DC
Plugging cycles	750
Approvals	CURUS
Pin dimensions = d	0.40 x 0.30 mm

**Note**

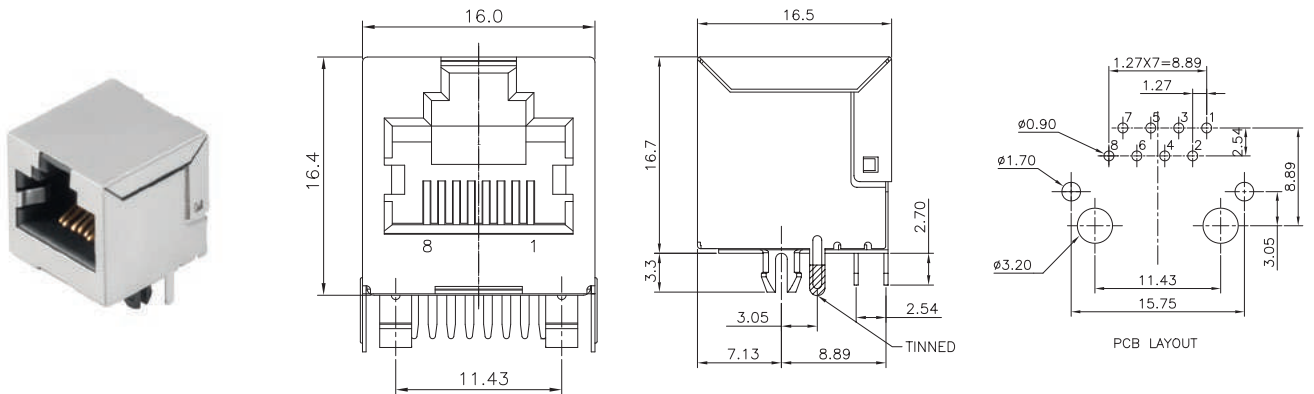

**Ordering data**

Type	Mounting onto the PCB	Latch option	Shield tabs	LED	Performance-Category	Packaging	Qty.	Order No.
RJ45C6 T1U 2.7N4N TY	THT solder connection	top	none	No	Cat. 6	Tray	160	1433910000

Other versions on request



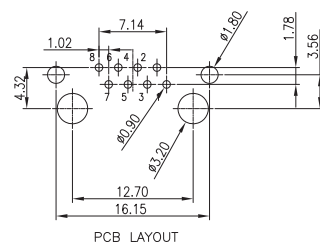
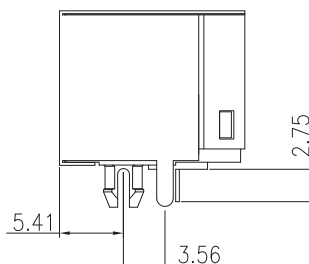
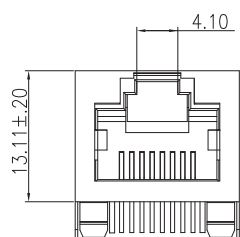

**Ordering data**

Type	Mounting onto the PCB	Latch option	Shield tabs	LED	Performance-Category	Packaging	Qty.	Order No.
RJ45C5 T1U 2.8N4N TY	THT solder connection	top	none	No	Cat. 5	Tray	140	1455240000

Other versions on request

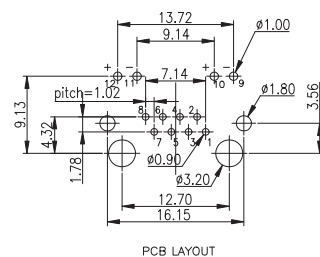
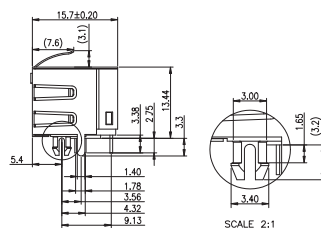
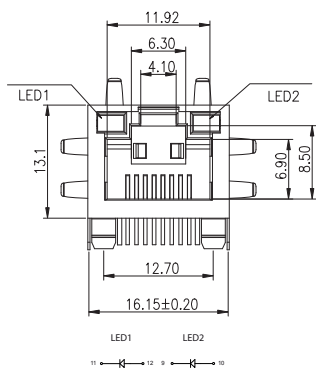

**Ordering data**

Type	Mounting onto the PCB	Latch option	Shield tabs	LED	Performance-Category	Packaging	Qty.	Order No.
RJ45C5 T1U 2.8E4G/Y TY	THT solder connection	top	6 tabs	Yes	Cat. 5	Tray (manual assembly)	140	2562880000

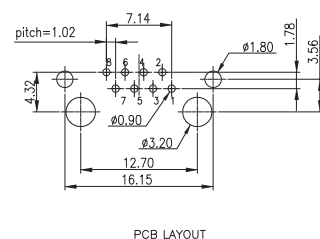
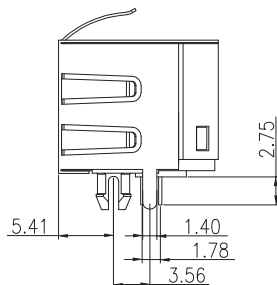
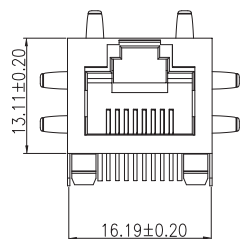

**Ordering data**

Type	Mounting onto the PCB	Latch option	Shield tabs	LED	Performance-Category	Packaging	Qty.	Order No.
RJ45C5 T1U 2.8E4N TY	THT solder connection	top	6 tabs	No	Cat. 5	Tray (manual assembly)	140	2562920000

<http://www.OMNIMATE.net>

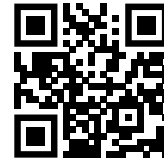
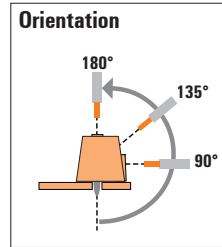

## RJ45 Transformer jacks

- With magnetics
- Shielded
- Contact surface 30μ" Au
- temperature range:  
-40 °C to +85 °C

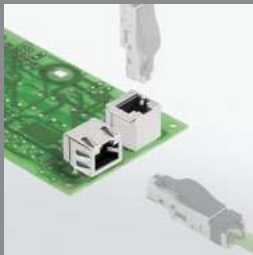

Mounting onto the PCB



SMT-soldering process



THR-soldering process



Wave soldering process

Reference picture	Outgoing elbow/ Latch option	Shield tabs	LED (left/right)	Performance category
	90° horizontal/latch down	No	No	10/100 Mbit/s
	180° vertical	No	YG/YG	1000 MBit/s
		No	YG/YG	10/100 Mbit/s
		No	Y/G	10/100 Mbit/s
	90° liegend/latch down	Yes	No	1000 MBit/s
		Yes	G/Y	1000 MBit/s
		Yes	No	10/100 Mbit/s
		Yes	G/Y	10/100 Mbit/s
		No	Y/G	10/100 Mbit/s
	90° horizontal/latch down Multiport	Yes	YG/YG	1000 MBit/s
		Yes	G/Y	1000 MBit/s
		No	YG/YG	1000 MBit/s
		No	G/Y	10/100 Mbit/s
	90° horizontal/latch down Multiport	Yes	No	10/100 Mbit/s
		Yes	G/Y	10/100 Mbit/s
	90° horizontal/latch down Multiport	Yes	G/Y	10/100 Mbit/s

Packaging	Order No.	Type
Tape	2564450000	RJ45M S1D DE4N RL
Tape	2562160000	RJ45G R1V 1.9N4YG/YG RL
Tape	2562150000	RJ45M R1V 1.9N4YG/YG RL
Tray	2461070000	RJ45M R1V 3.3N4Y/G TY
Tape	2564440000	RJ45G1 R1D 3.2E4N RL
Tray	2544510000	RJ45G1 R1D 3.3E4G/Y TY
Tape	2564430000	RJ45M R1D 3.2E4N RL
Tape	2564410000	RJ45M R1D 3.3E4G/Y RL
Tray	2461060000	RJ45M R1D 3.3N4Y/G TY
Tape	2036510000	RJ45G1 R12D 3.3E4YG/YG RL
Tray	2544500000	RJ45G1 R12D 3.3E4G/Y TY
Tape	2485370000	RJ45G1 R12D 3.3N4YG/YG RL
Tape	2551900000	RJ45M R12D 3.2N4G/Y RL
Tray	2474160000	RJ45M T1D 3.2E4N TY
Tray	2563850000	RJ45M T1D 3.3E4G/Y TY
Tape	2036460000	RJ45M T12D 3.3E4G/Y RL

RJ45 G1 R1U 3.2E4 GY/GY TY RJ45G1 R1U 3.2E4GY/GY TY		
<b>Packaging</b>	<b>TY</b> <b>RL</b>	<b>Tray</b> in box (manual assembly) <b>Tape on Reel</b> (automated assembly)
<b>LED</b>	<b>Y/G</b> <b>G/Y</b> <b>GY/GY</b> <b>O/G</b> <b>R/O</b> ... <b>N</b>	<b>Yellow/Green</b> <b>Green/Yellow</b> (standard) <b>Green-Yellow/Green-Yellow</b> <b>Orange/Green</b> <b>Red/Orange</b> ... (further combinations possible) without LED
<b>Contact surface thickness</b>	<b>4</b>	1 = 3µm, 2 = 6µm, 3 = 15µm, <b>4 = 30µm</b> , 5 = 50µm
<b>EMI tabs (ground fingers)</b>	<b>E</b> <b>N</b>	<b>E</b> = with EMI tabs <b>N</b> = without EMI tabs
<b>Solder Pin length</b>	<b>3.2</b> <b>1.6</b> <b>D</b>	3.2 mm 1.6 mm <b>SMD</b>
<b>Direction, latch style</b>	<b>U</b> <b>D</b> <b>V</b> <b>Y</b>	<b>Horizontal</b> (90°, side entry), latch <b>up</b> <b>Horizontal</b> (90°, side entry), latch <b>down</b> <b>Vertical</b> (180°, top entry) <b>Diagonal</b> (45°), latch up
<b>Number of Ports</b>	<b>1</b> <b>12; 14; ...</b> <b>21; 41; ...</b>	<b>1 Port</b> multi ports side by side, Multiport multi ports about each other, Multilevel
<b>Assembly on PCB</b>	<b>R</b> <b>S</b> <b>T</b>	<b>Through Hole Reflow - THR</b> Soldering process: Wave or Reflow soldering <b>Surface Mount Technology - SMT</b> Soldering process: Reflow soldering <b>Through Hole Technology - THT</b> Soldering process: Wave
<b>Performance Category</b>	<b>C5</b> <b>C6</b> <b>C6A</b> <b>C5e</b> <b>M</b> <b>G1</b> <b>G10</b> <b>U</b> <b>MP</b> <b>MP+</b>	<b>Category 5</b> <b>Category 6</b> <b>Category 6A</b> <b>Category 5e</b> <b>10/100 Mbit</b> <b>10/100/1000 Mbit</b> <b>10 Gbit</b> <b>Unshielded</b> <b>10/100 Mbit with POE</b> <b>10/100 Mbit with POE+</b>

# RJ45 transformer jacks for SMT soldering process

## 1x1 port, 90° (horizontal) latch down

For additional articles and information, refer to [catalog.weidmueller.com](http://catalog.weidmueller.com)

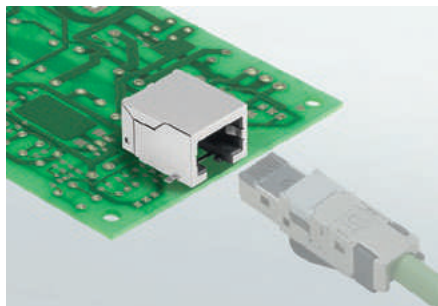

- With integrated magnetics
- 360° shielding
- Contact surface 30µm (0.76µm) Au
- ≥750 plugging cycles
- Extended temperature range: -40 °C to +85 °C
- For fully automatic assembly (tape-on-reel)
- Optimised package sizes
- Other variations on request

### Characteristics

Inductance	350 µH min. at 100 kHz, 100 mV, 8 mA DC Bias
Leakage Inductance	0.3 µH max. at 100 kHz, 100 mV
Insertion Loss	1.1 dB max. at (1 - 100) MHz
Return Loss	18 dB min. at (1 - 30) MHz 16 dB min. at (30 - 60) MHz 12 dB min. at (60 - 80) MHz
Cross Talk	30 dB min. at (1 - 100) MHz
Common Mode Rejection	30 dB min. at (1 - 100) MHz

### Technical data

Outgoing elbow	90°
Pitch	1.27 mm
Type of insulation material	PA 9T
Colour	Black
UL 94 flammability rating	V-0
Moisture Level (MSL)	1
Shielding material	Brass
Shield surface	nickel-plated
Contact base material	Phosphorus bronze
<b>Note</b>	

Layer structure of plug contact	30-80 µm Ni / 30-µm Au
Operating temperature	-40...85 °C
Rated voltage	125 V AC
Rated current	1.5 A
Dielectric strength, contact / contact	1000 V DC
Insulation resistance	> 500 MΩ
Plugging cycles	750
Approvals	CURUS
Pin dimensions = d	

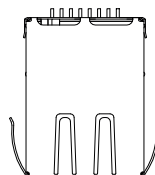
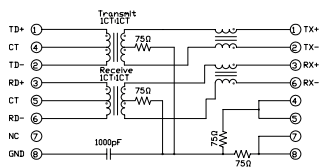
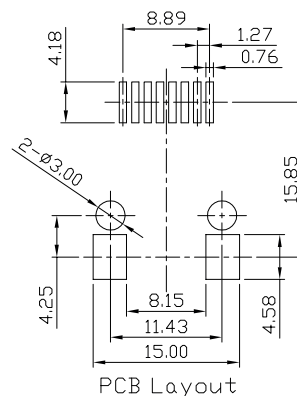
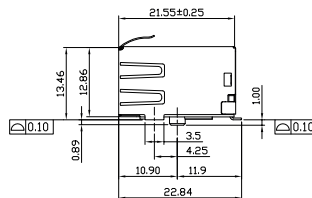
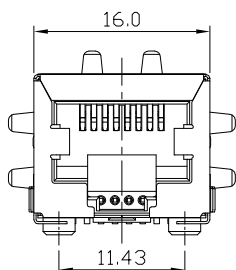

### Ordering data

Type	Mounting onto the PCB	Latch option	Shield tabs	LED	Performance-Category	Packaging	Qty.	Order No.
RJ45M S1D DE4N RL	SMD solder connection		6 tabs	No	10/100 MBit/s	Tape	200	2564450000



# RJ45 transformer jacks for THR soldering process

1x1 port, 180° (vertical)

For additional articles and information, refer to [catalog.weidmuller.com](http://catalog.weidmuller.com)

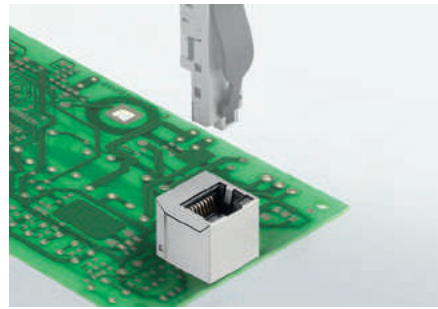

- With integrated magnetics
- 360° shielding
- Contact surface 30µm (0.76µm) Au
- ≥750 plugging cycles
- Extended temperature range: -40 °C to +85 °C
- For fully automated assembly (tape-on-reel) or manual assembly (tray)
- Optimised package sizes
- Other variations on request

### Characteristics

Inductance	350 µH min. at 100 kHz, 100 mV, 8 mA DC Bias
Leakage Inductance	0.3 µH max. at 100 kHz, 100 mV
Insertion Loss	1.1 dB max. at (1 - 100) MHz
Return Loss	18 dB min. at (1 - 30) MHz 16 dB min. at (30 - 60) MHz 12 dB min. at (60 - 80) MHz
Cross Talk	30 dB min. at (1 - 100) MHz
Common Mode Rejection	30 dB min. at (1 - 100) MHz

### Technical data

Outgoing elbow	180°
Pitch	1.27 mm
Type of insulation material	PA 9T
Colour	Black
UL 94 flammability rating	V-0
Moisture Level (MSL)	1
Shielding material	Brass
Shield surface	nickel-plated
Contact base material	Phosphorus bronze
<b>Note</b>	

Layer structure of plug contact	30-80 µm Ni / 30-µm Au
Operating temperature	-40...85 °C
Rated voltage	125 V AC
Rated current	1.5 A
Dielectric strength, contact / contact	1000 V DC
Insulation resistance	> 500 MΩ
Plugging cycles	750
Approvals	CURUS
Pin dimensions = d	

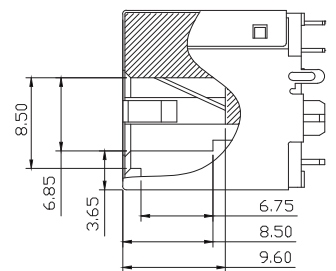
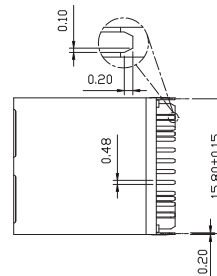
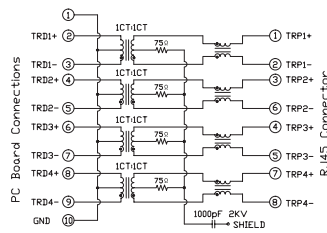
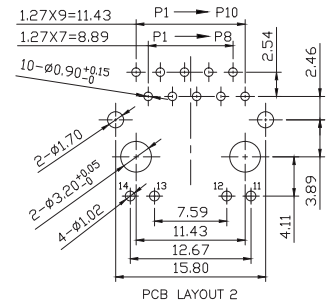
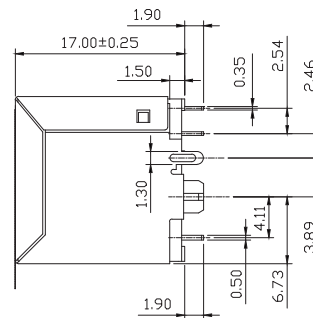
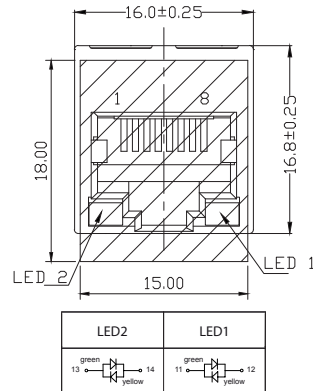

### Ordering data

Type	Mounting onto the PCB	Latch option	Shield tabs	LED	Performance-Category	Packaging	Qty.	Order No.
RJ45G R1V 1.9N4YG/YG RL	THT/THR solder connection		none	Yes	1000 Mbps	Tape	200	2562160000





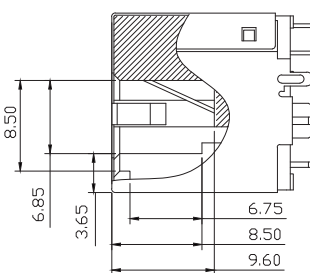
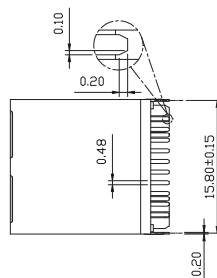
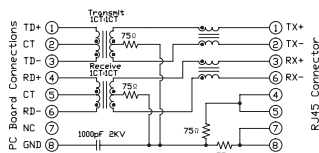
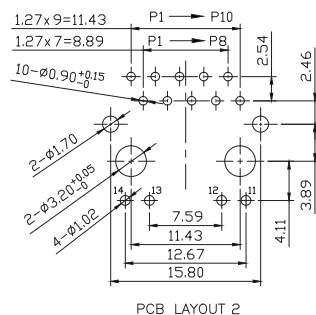
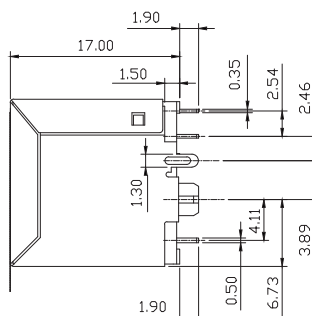
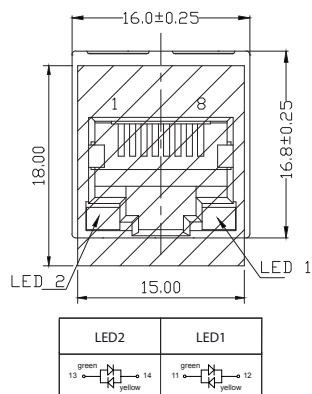

Ordering data

Type	Mounting onto the PCB	Latch option	Shield tabs	LED	Performance-Category	Packaging	Qty.	Order No.
RJ45M R1V 1.9N4YG/YG RL	THT/THR solder connection		none	Yes	10/100 MBit/s	Tape	200	2562150000

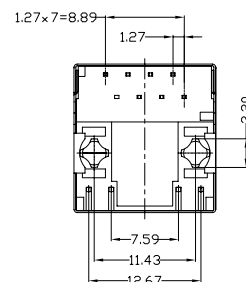
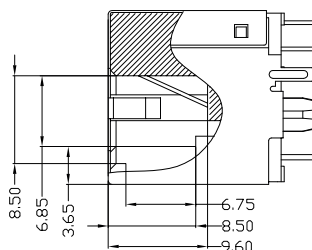
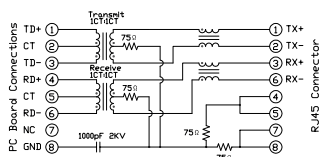
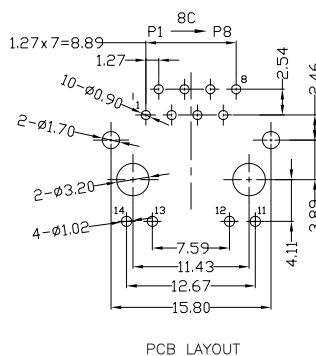
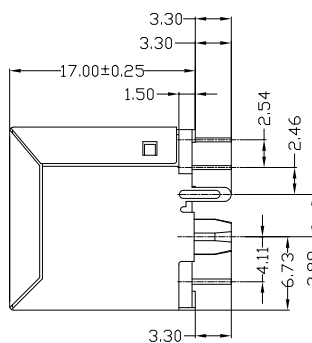
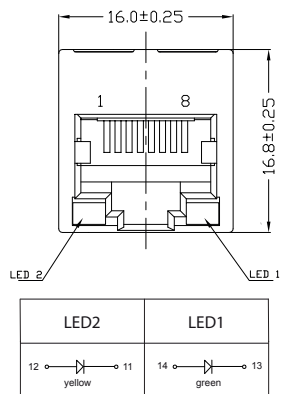

Ordering data

Type	Mounting onto the PCB	Latch option	Shield tabs	LED	Performance-Category	Packaging	Qty.	Order No.
RJ45M R1V 3.3N4Y/G TY	THT/THR solder connection		none	Yes	10/100 MBit/s	Tray (manual assembly)	120	2461070000

# RJ45 transformer jacks for THR soldering process

## 1x1 port, 90° (horizontal) latch down

For additional articles and information, refer to [catalog.weidmueller.com](http://catalog.weidmueller.com)

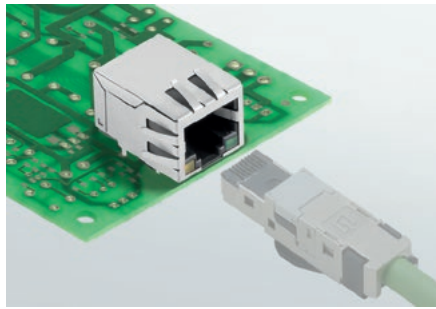

- With integrated magnetics
- 360° shielding
- Contact surface 30µm (0.76µm) Au
- ≥750 plugging cycles
- Extended temperature range: -40 °C to +85 °C
- For fully automated assembly (tape-on-reel) or manual assembly (tray)
- Optimised package sizes
- Other variations on request

### Characteristics

Inductance	350 µH min. at 100 kHz, 100 mV, 8 mA DC Bias
Leakage Inductance	0.3 µH max. at 100 kHz, 100 mV
Insertion Loss	1.1 dB max. at (1 - 100) MHz
Return Loss	18 dB min. at (1 - 30) MHz 16 dB min. at (30 - 60) MHz 12 dB min. at (60 - 80) MHz
Cross Talk	30 dB min. at (1 - 100) MHz
Common Mode Rejection	30 dB min. at (1 - 100) MHz

### Technical data

Outgoing elbow	90°
Pitch	1.27 mm
Type of insulation material	PA 9T
Colour	Black
UL 94 flammability rating	V-0
Shielding material	Brass
Shield surface	nickel-plated
Contact base material	Phosphorus bronze

Layer structure of plug contact	30-80 µm Ni / 30-µm Au
Operating temperature	-40...85 °C
Rated voltage	125 V AC
Rated current	1.5 A
Dielectric strength, contact / contact	1000 V DC
Insulation resistance	> 500 MΩ
Plugging cycles	750
Approvals	
Pin dimensions = d	

### Note

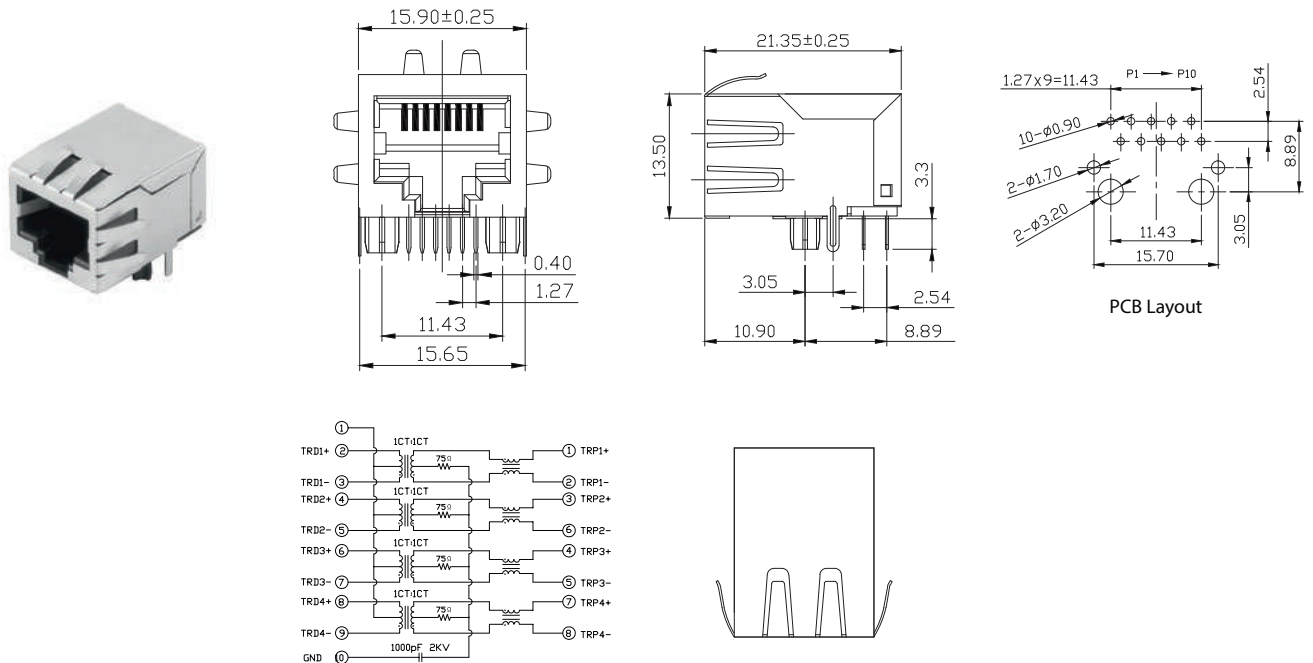

### Ordering data

Type	Mounting onto the PCB	Latch option	Shield tabs	LED	Performance-Category	Packaging	Qty.	Order No.
RJ45G1 R1D 3.2E4N RL	THT/THR solder connection	bottom	6 tabs	No	1000 Mbps	Tape	200	2564440000

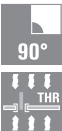

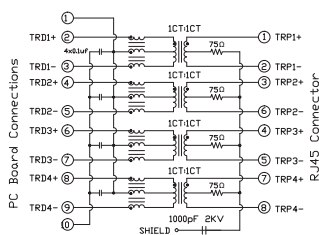
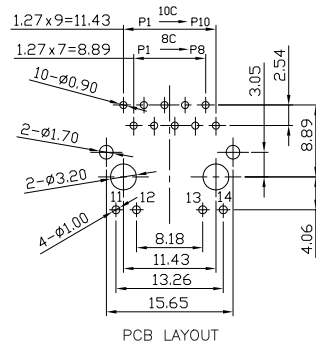
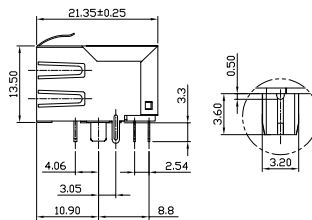
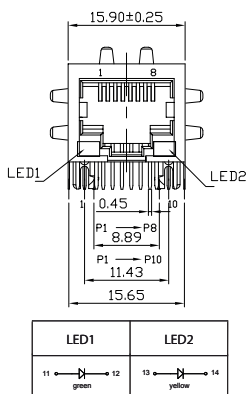

Ordering data

Type	Mounting onto the PCB	Latch option	Shield tabs	LED	Performance-Category	Packaging	Qty.	Order No.
RJ45G1 R1D 3.3E4G/Y TY	THT/THR solder connection	bottom	6 tabs	Yes	1000 Mbps	Tray (manual assembly)	120	2544510000

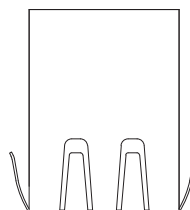
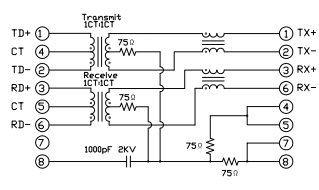
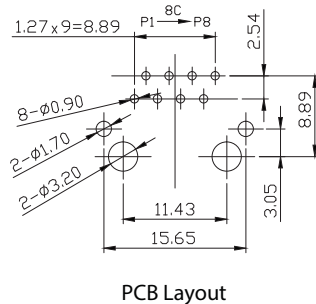
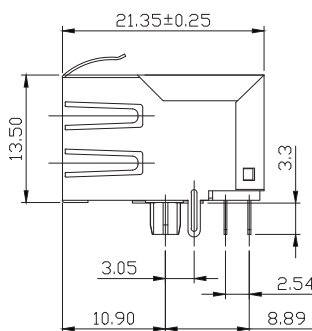
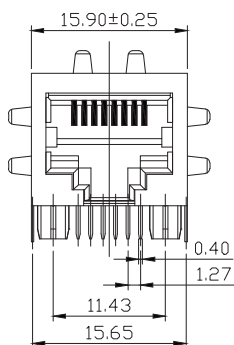

Ordering data

Type	Mounting onto the PCB	Latch option	Shield tabs	LED	Performance-Category	Packaging	Qty.	Order No.
RJ45M R1D 3.2E4N RL	THT/THR solder connection	bottom	6 tabs	No	10/100 MBit/s	Tape	200	2564430000

# RJ45 transformer jacks for THR soldering process

OMNIMATE® Data

B

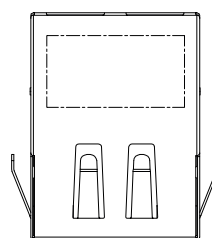
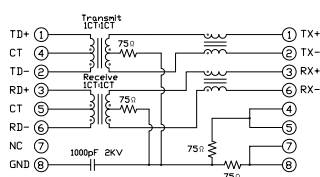
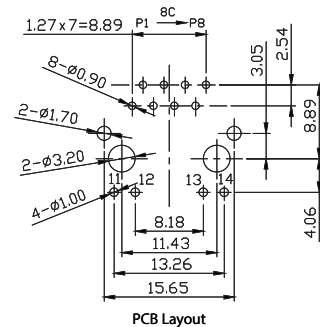
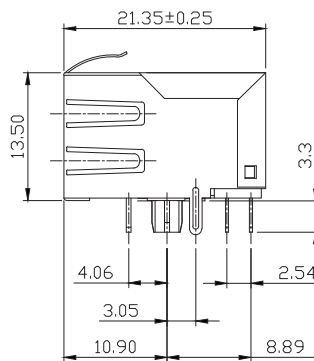
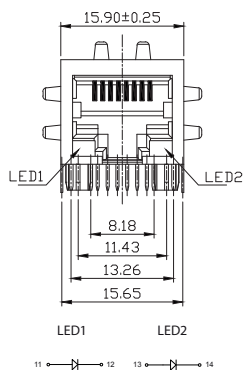

## Ordering data

Type	Mounting onto the PCB	Latch option	Shield tabs	LED	Performance-Category	Packaging	Qty.	Order No.
RJ45M R1D 3.3E4G/Y RL	THT/THR solder connection	bottom	6 tabs	Yes	10/100 MBit/s	Tape	120	25644 10000

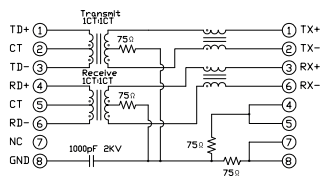
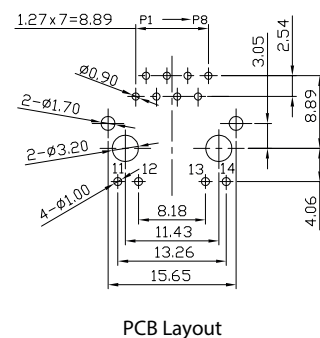
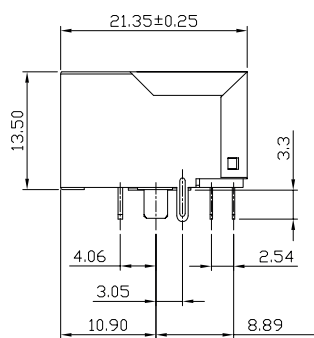
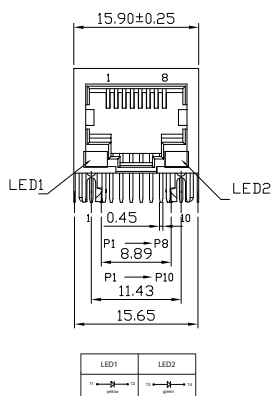

90°

THR

## Ordering data

Type	Mounting onto the PCB	Latch option	Shield tabs	LED	Performance-Category	Packaging	Qty.	Order No.
RJ45M R1D 3.3N4Y/G TY	THT/THR solder connection	bottom	none	Yes	10/100 MBit/s	Tray (manual assembly)	120	2461060000



# RJ45 transformer jacks for THR soldering process

## 1x2 multiport, 90° (horizontal) latch down

For additional articles and information, refer to [catalog.weidmuller.com](http://catalog.weidmuller.com)

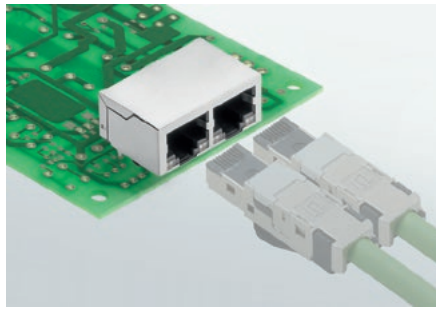

- With integrated magnetics
- 360° shielding
- Contact surface 30µm (0.76µm) Au
- ≥750 plugging cycles
- Extended temperature range: -40 °C to +85 °C
- For fully automated assembly (tape-on-reel) or manual assembly (tray)
- Optimised package sizes
- Other variations on request

### Characteristics

Inductance	350 µH min. at 100 kHz, 100 mV, 8 mA DC Bias
Leakage Inductance	0.3 µH max. at 100 kHz, 100 mV
Insertion Loss	1.1 dB max. at (1 - 100) MHz
Return Loss	18 dB min. at (1 - 30) MHz 16 dB min. at (30 - 60) MHz 12 dB min. at (60 - 80) MHz
Cross Talk	30 dB min. at (1 - 100) MHz
Common Mode Rejection	30 dB min. at (1 - 100) MHz

### Technical data

Outgoing elbow	90°
Pitch	1.27 mm
Type of insulation material	PA 9T
Colour	Black
UL 94 flammability rating	V-0
Moisture Level (MSL)	1
Shielding material	Brass
Shield surface	nickel-plated
Contact base material	Phosphorus bronze
<b>Note</b>	

Layer structure of plug contact	30-80 µm Ni / 30-µm Au
Operating temperature	-40...85 °C
Rated voltage	125 V
Rated current	1.5 A
Dielectric strength, contact / contact	≥ 1000 V DC
Insulation resistance	> 500 MΩ
Plugging cycles	750
Approvals	CURUS
Pin dimensions = d	0.40 x 0.30 mm, LED pins = 0.50 x 0.50 mm

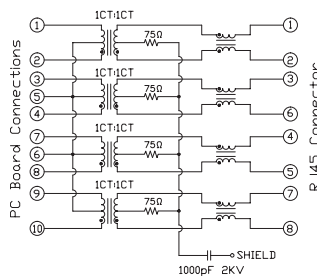
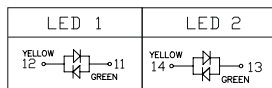
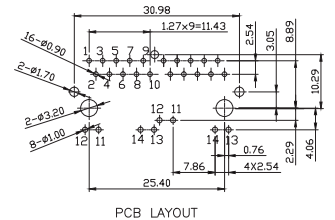
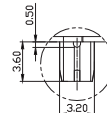
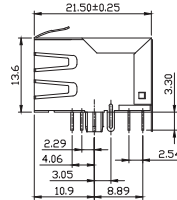
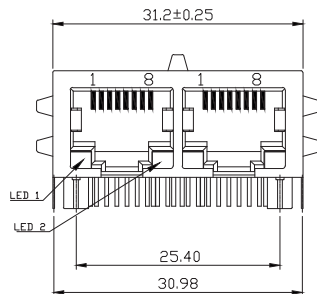

### Ordering data

Type	Mounting onto the PCB	Latch option	Shield tabs	LED	Performance-Category	Packaging	Qty.	Order No.
RJ45G1 R12D 3.3E4YG/YG RL	THT/THR solder connection	bottom	6 tabs	Yes	1000 Mbps	Tape	200	2036510000

OMNIMATE® Data

B

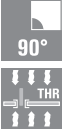

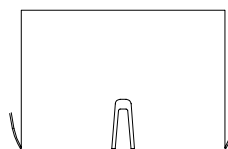
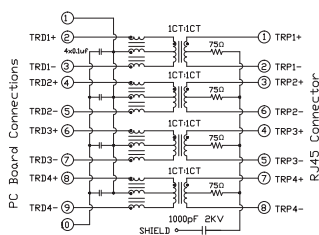
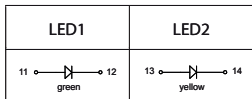
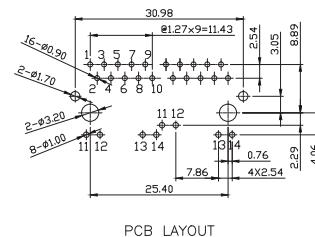
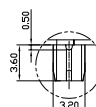
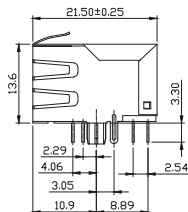
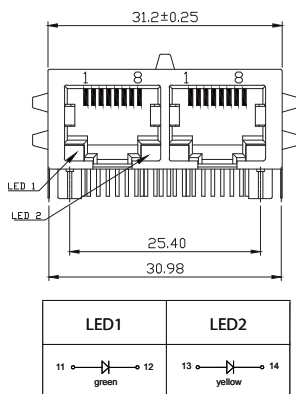

Ordering data

Type	Mounting onto the PCB	Latch option	Shield tabs	LED	Performance-Category	Packaging	Qty.	Order No.
RJ45G1 R12D 3.3E4G/Y TY	THT/THR solder connection	bottom	6 tabs	Yes	1000 Mbps	Tray (manual assembly)	80	2544500000

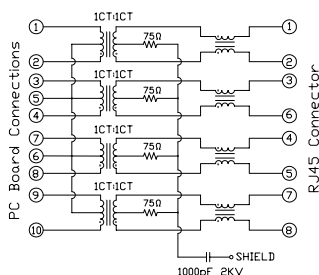
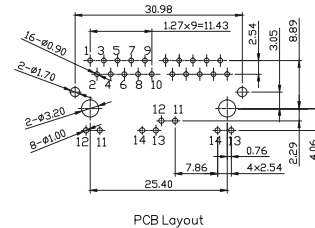
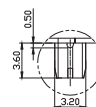
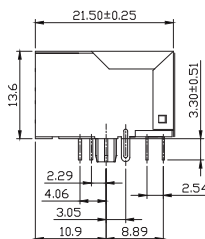
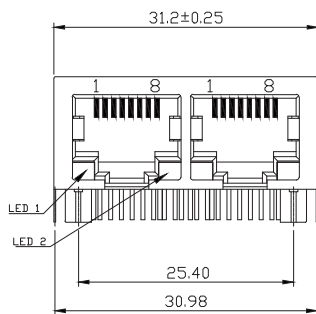

Ordering data

Type	Mounting onto the PCB	Latch option	Shield tabs	LED	Performance-Category	Packaging	Qty.	Order No.
RJ45G1 R12D 3.3N4YG/YG RL	THT/THR solder connection	bottom	none	Yes	1000 Mbps	Tape	200	2485370000

# RJ45 transformer jacks for THR soldering process

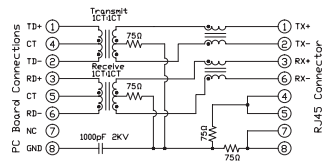
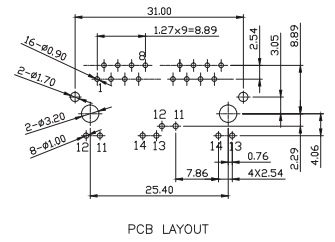
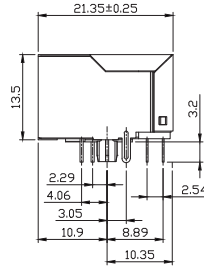
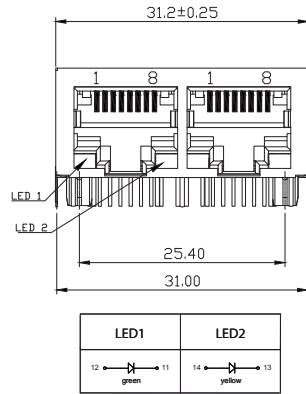

## Ordering data

Type	Mounting onto the PCB	Latch option	Shield tabs	LED	Performance-Category	Packaging	Qty.	Order No.
RJ45M R12D 3.2N4G/Y RL	THT/THR solder connection	bottom	none	Yes	10/100 MBit/s	Tape	200	<b>2551900000</b>

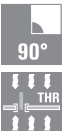





# RJ45 transformer jacks for wave soldering process

## 1x1 port, 90° (horizontal) latch down

For additional articles and information, refer to [catalog.weidmueller.com](http://catalog.weidmueller.com)

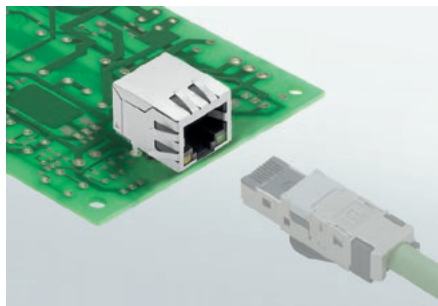

- With integrated magnetics
- 360° shielding
- Contact surface 30µm (0.76µm) Au
- ≥750 plugging cycles
- Extended temperature range: -40 °C to +85 °C
- For or manual assembly (tray)
- Optimised package sizes
- Other variations on request

### Characteristics

Inductance	350 µH min. at 100 kHz, 100 mV, 8 mA DC Bias
Leakage Inductance	0.3 µH max. at 100 kHz, 100 mV
Insertion Loss	1.1 dB max. at (1 - 100) MHz
Return Loss	18 dB min. at (1 - 30) MHz 16 dB min. at (30 - 60) MHz 12 dB min. at (60 - 80) MHz
Cross Talk	30 dB min. at (1 - 100) MHz
Common Mode Rejection	30 dB min. at (1 - 100) MHz

### Technical data

Outgoing elbow	90°
Pitch	1.27 mm
Type of insulation material	PA 66
Colour	Black
UL 94 flammability rating	V-0
Shielding material	Brass
Shield surface	nickel-plated
Contact base material	Phosphorus bronze

Layer structure of plug contact	30-80 µm Ni / 30-µm Au
Operating temperature	-40...85 °C
Rated voltage	125 V AC
Rated current	1.5 A
Dielectric strength, contact / contact	≥ 1000 V DC
Insulation resistance	> 500 MΩ
Plugging cycles	750
Approvals	CURUS
Pin dimensions = d	

### Note

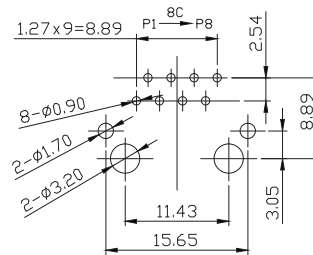
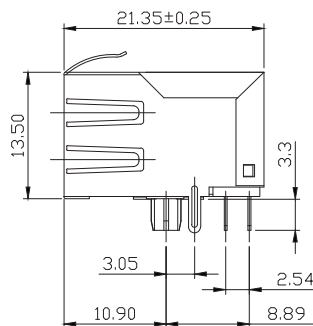
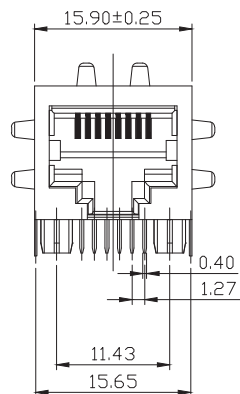

PCB Layout

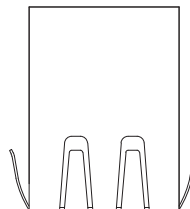
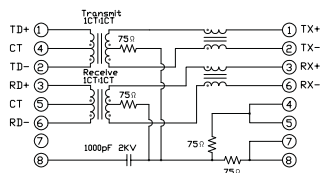

### Ordering data

Type	Mounting onto the PCB	Latch option	Shield tabs	LED	Performance-Category	Packaging	Qty.	Order No.
RJ45M T1D 3.2E4N TY	THT solder connection	bottom	6 tabs	No	10/100 MBit/s	Tray (manual assembly)	120	2474160000

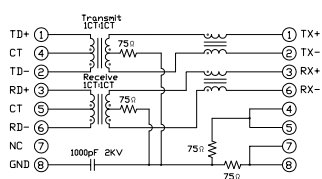
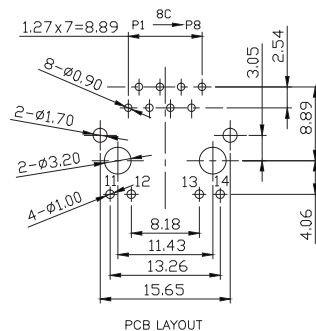
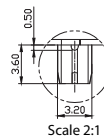
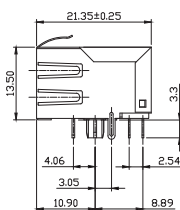
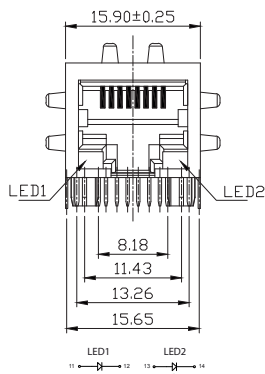

### Ordering data

Type	Mounting onto the PCB	Latch option	Shield tabs	LED	Performance-Category	Packaging	Qty.	Order No.
RJ45M T1D 3.3E4G/Y TY	THT solder connection	bottom	6 tabs	Yes	10/100 MBit/s	Tray (manual assembly)	120	<b>2563850000</b>

# RJ45 transformer jacks for wave soldering process

## 1x2 multiport, 90° (horizontal) latch down

For additional articles and information, refer to [catalog.weidmueller.com](http://catalog.weidmueller.com)

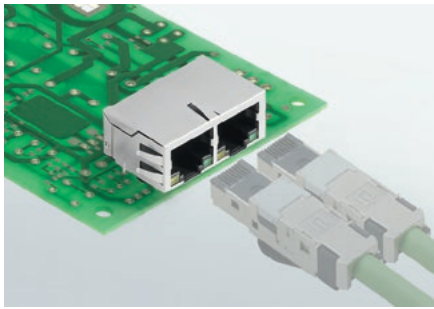

- With integrated magnetics
- 360° shielding
- Contact surface 30µm (0.76µm) Au
- ≥750 plugging cycles
- Extended temperature range: -40 °C to +85 °C
- For fully automatic assembly (tape-on-reel)
- Optimised package sizes
- Other variations on request

### Characteristics

Inductance	350 µH min. at 100 kHz, 100 mV, 8 mA DC Bias
Leakage Inductance	0.3 µH max. at 100 kHz, 100 mV
Insertion Loss	1.1 dB max. at (1 - 100) MHz
Return Loss	18 dB min. at (1 - 30) MHz 16 dB min. at (30 - 60) MHz 12 dB min. at (60 - 80) MHz
Cross Talk	30 dB min. at (1 - 100) MHz
Common Mode Rejection	30 dB min. at (1 - 100) MHz

### Technical data

Outgoing elbow	90°
Pitch	1.27 mm
Type of insulation material	PA 66
Colour	Black
UL 94 flammability rating	V-0
Shielding material	Brass
Shield surface	nickel-plated
Contact base material	Phosphorus bronze

Layer structure of plug contact	30-80 µm Ni / 30-µm Au
Operating temperature	-40...85 °C
Rated voltage	125 V AC
Rated current	1.5 A
Dielectric strength, contact / contact	≥ 1000 V DC
Insulation resistance	> 500 MΩ
Plugging cycles	750
Approvals	CURUS
Pin dimensions = d	0.40 x 0.30 mm, LED pins = 0.50 x 0.50 mm

### Note

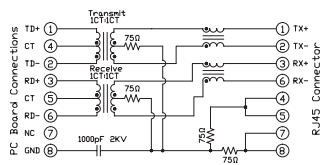
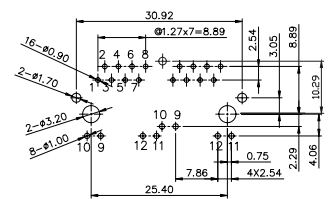
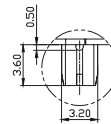
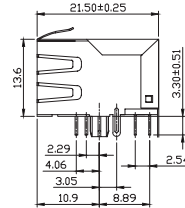
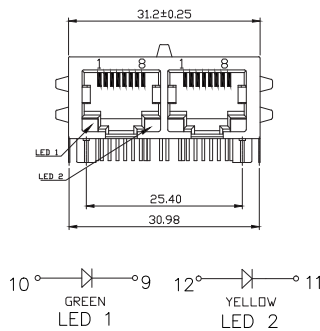

### Ordering data







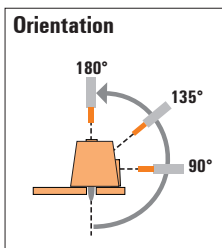



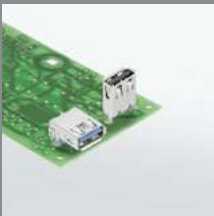

Type	Mounting onto the PCB	Latch option	Shield tabs	LED	Performance-Category	Packaging	Qty.	Order No.
RJ45M T12D 3.3E4G/Y RL	THT solder connection	bottom	6 tabs	Yes	10/100 MBit/s	Tape	200	2036460000



<http://www.OMNIMATE.net>



## USB 3.0/2.0 jacks

	Mounting onto the PCB	Reference picture	Outgoing elbow	Performance		Order No.	Type	
				category	Packaging			
<p>Rated current up to 1,5 A</p> <ul style="list-style-type: none"> <li>• Up to 1500 mating cycles</li> <li>• Backwards compatible</li> </ul> 	 <p><b>SMT-soldering process</b></p>		180° vertical	480 Mbit/s	Tray	<b>on request</b>	USB2.0A S1V 1.4N4 TY BK	
			90° horizontal	480 Mbit/s	Tray	<b>2563720000</b>	USB2.0A S1H 1.4N4 TY BK	
	 <p><b>THR-soldering process</b></p>		180° vertical	480 Mbit/s	Tray	<b>2563730000</b>	USB2.0A R1V 2.5N4 TY BK	
			180° vertical	5 Gbit/s	Tray	<b>1549730000</b>	USB3.0A R1V 3.0N2 TY BL	
			90° horizontal	480 Mbit/s	Tray	<b>on request</b>	USB2.0A R1H 2.5N4 TY BK	
		 <p><b>Wave soldering process</b></p>		180° vertical	480 Mbit/s	Tray	<b>1985910000</b>	USB2.0A T1V 2.5N4 TY BK
				90° horizontal	480 Mbit/s	Tray	<b>2563710000</b>	USB2.0A T1H 2.5N4 TY BK
				90° horizontal	5 Gbit/s	Tray	<b>2563550000</b>	USB3.0A T1H 2.3N4 TY BL

USB 3.0A R 1 V 3.0 N 4 TY BL USB3.0A R1V 3.0N4 TY BL

<b>Colour / Special Option</b>	<b>BL</b>	blue (plastic)
	<b>BK</b>	black (plastic)
	<b>WH</b>	white (plastic)
<b>Packaging</b>	<b>TY</b>	Tray in box (manual assembly)
	<b>RL</b>	Tape on Reel (automated assembly)
	<b>TU</b>	Tube
<b>Contact surface thickness</b>	<b>4</b>	1 = 3µ, 2 = 6µ, 3 = 15µ, 4 = 30µ, 5 = 50µ
	<b>N</b>	no use
<b>Solder Pin length</b>	<b>3.2</b>	3.2 mm
	<b>1.6</b>	1.6 mm
	<b>D</b>	SMD
<b>Direction</b>	<b>H</b>	Horizontal (90°, side entry)
	<b>U</b>	Horizontal, Upright 90°
	<b>V</b>	Vertical (180°, top entry)
<b>Number of Ports</b>	<b>1</b>	1 Port
	<b>21; 41; ...</b>	multi ports about each other, Multilevel
<b>Assembly on PCB</b>	<b>R</b>	Through Hole Reflow - THR Soldering process: Wave or Reflow soldering
	<b>S</b>	Surface Mount Technology - SMT Soldering process: Reflow soldering
	<b>T</b>	Through Hole Technology - THT Soldering process: Wave
<b>Type / Performance</b>	<b>2.0A</b>	USB 2.0 Type A
	<b>3.0A</b>	USB 3.0 Type A

**USB jacks  
for SMT soldering process**

**Type 2.0 A, 90° (lying)**

For additional articles and information, refer to [catalog.weidmueller.com](http://catalog.weidmueller.com)

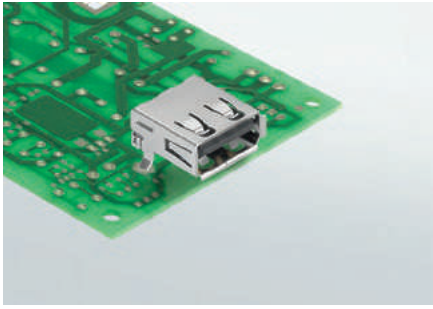

- Rated current up to 1.5 A
- Up to 1500 plugging cycles
- Downward compatible

**Technical data**

Outgoing elbow	90°
Pitch	2.00 mm
Type of insulation material	LCP
Colour	Black
UL 94 flammability rating	V-0
Moisture Level (MSL)	1
Shielding material	Brass
Shield surface	nickel-plated
Contact base material	Phosphorus bronze
<b>Note</b>	

Layer structure of plug contact	30-80 µ" Ni / 30-µ" Au
Operating temperature	-40...60 °C
Rated voltage	30 V
Rated current	1.5 A
Dielectric strength, contact / contact	750 V AC
Insulation resistance	≥ 1000 MΩ

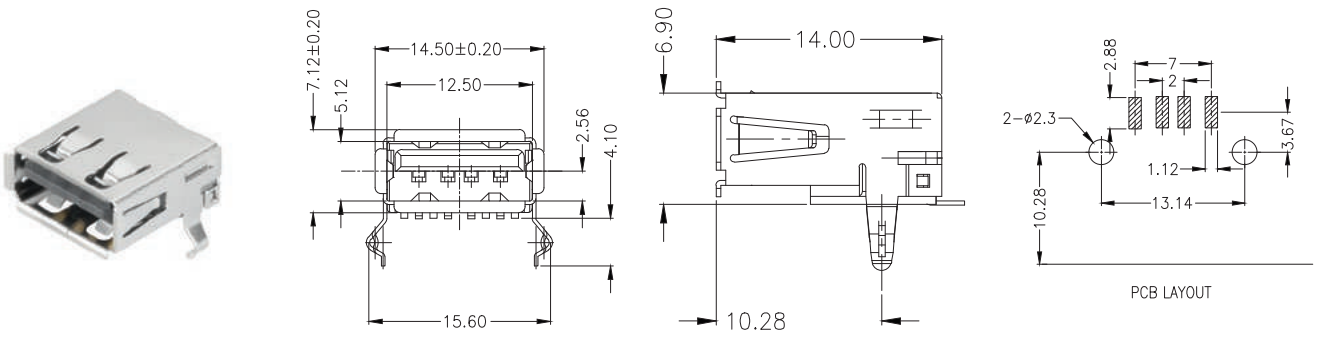

**Ordering data**

Type	Mounting onto the PCB	Plugging cycles	Performance-Category	Packaging	Qty.	Order No.
USB2.0A S1H 1.4N4 TY BK	THT/THR solder connection	≥ 1500	480 Mbps	Tray (manual assembly)	100	<b>2563720000</b>

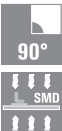





**USB jacks  
for THR soldering process**

**Type 3.0/2.0 A, 180° (vertical)**

For additional articles and information, refer to [catalog.weidmuller.com](http://catalog.weidmuller.com)

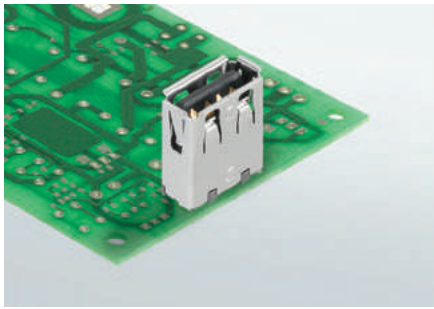

- Rated current up to 1.5 A
- Up to 1500 plugging cycles
- Downward compatible

**Technical data**

Outgoing elbow	180°
Pitch	2.00 mm
Type of insulation material	LCP
Colour	Black
UL 94 flammability rating	V-0
Moisture Level (MSL)	1
Shielding material	Brass
Shield surface	nickel-plated
Contact base material	Phosphorus bronze
<b>Note</b>	

Layer structure of plug contact	30-80 µ" Ni / 30-µ" Au
Operating temperature	-20...60 °C
Rated voltage	30 V
Rated current	1.5 A at 250 V AC
Dielectric strength, contact / contact	500 V AC
Insulation resistance	≥ 1000 MΩ

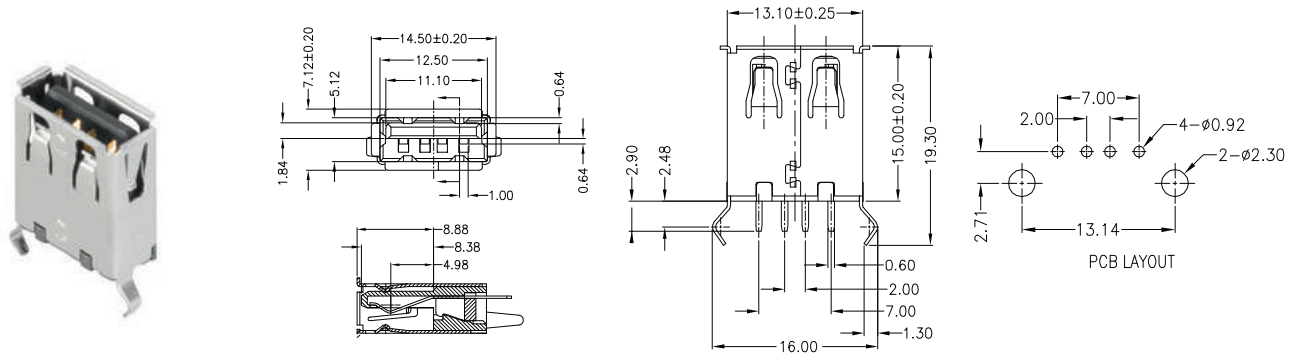

**Ordering data**

Type	Mounting onto the PCB	Plugging cycles	Performance-Category	Packaging	Qty.	Order No.
USB2.0A R1V 2.5N4 TY BK	THT/THR solder connection	≥ 1500	480 Mbps	Tray (manual assembly)	100	<b>2563730000</b>



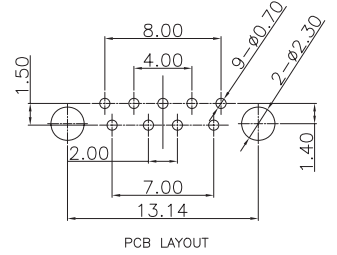
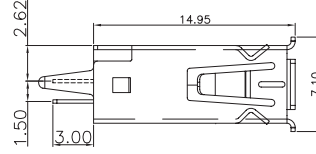
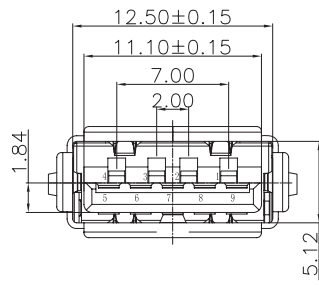

**Ordering data**

Type	Mounting onto the PCB	Plugging cycles	Performance-Category	Packaging	Qty.	Order No.
USB3.0A R1V 3.0N2 TY BL	THT/THR solder connection	≥ 1500	5 Gbps	Tray (manual assembly)	100	1549730000

**USB jacks**  
for wave soldering process

**Type 3.0/2.0 A, 180° (vertical)**

For additional articles and information, refer to [catalog.weidmueller.com](http://catalog.weidmueller.com)

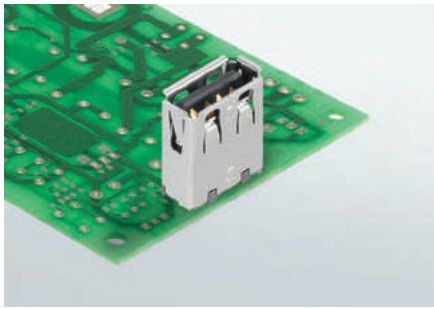

- Rated current up to 1.5 A
- Up to 1500 plugging cycles
- Downward compatible

**Technical data**

Outgoing elbow	180°
Pitch	2.00 mm
Type of insulation material	PBT
Colour	Black
UL 94 flammability rating	V-0
Shielding material	Brass
Shield surface	nickel-plated
Contact base material	Phosphorus bronze

Layer structure of plug contact	30-80 μ" Ni / 30-μ" Au
Operating temperature	-40...60 °C
Rated voltage	30 V
Rated current	1.5 A at 250 V AC
Dielectric strength, contact / contact	500 V AC
Insulation resistance	≥ 1000 MΩ

**Note**

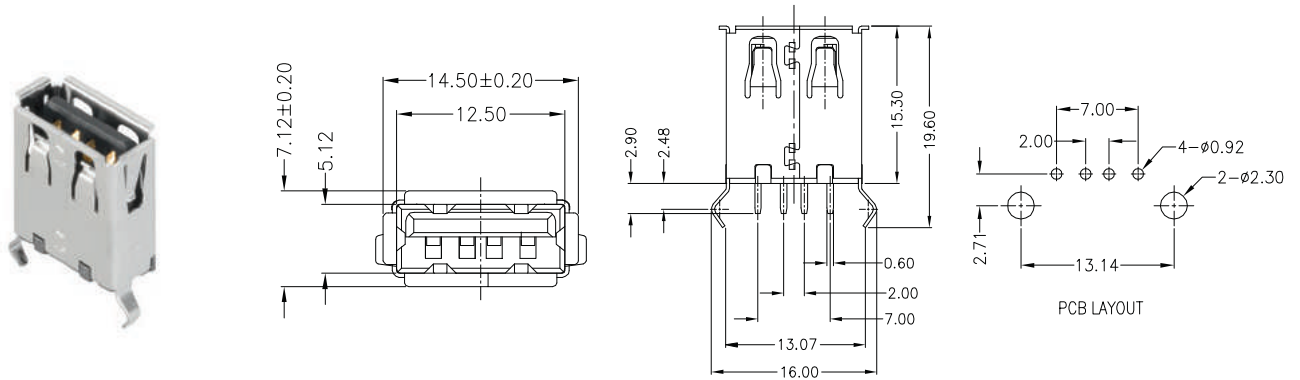

**Ordering data**

Type	Mounting onto the PCB	Plugging cycles	Performance-Category	Packaging	Qty.	Order No.
USB2.0A T1V 2.5N4 TY BK	THT solder connection	≥ 1500	480 Mbps	Tray (manual assembly)	100	<b>1985910000</b>





**USB jacks**  
for wave soldering process

**Type 3.0/2.0 A, 180° (vertical)**

For additional articles and information, refer to [catalog.weidmueller.com](http://catalog.weidmueller.com)

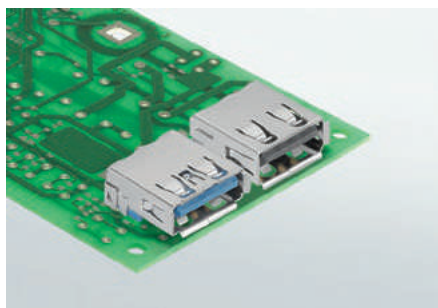

- Rated current up to 1.5 A
- Up to 1500 plugging cycles
- Downward compatible

OMNIMATE® Data

B

**Technical data**

Outgoing elbow	90°
Pitch	2.00 mm
Type of insulation material	PBT
Colour	Black
UL 94 flammability rating	V-0
Shielding material	Brass
Shield surface	nickel-plated
Contact base material	Phosphorus bronze

Layer structure of plug contact	30-80 µ" Ni / 30-µ" Au
Operating temperature	-20...60 °C
Rated voltage	30 V
Rated current	1.5 A at 250 V AC
Dielectric strength, contact / contact	500 V AC
Insulation resistance	≥ 1000 MΩ

**Note**

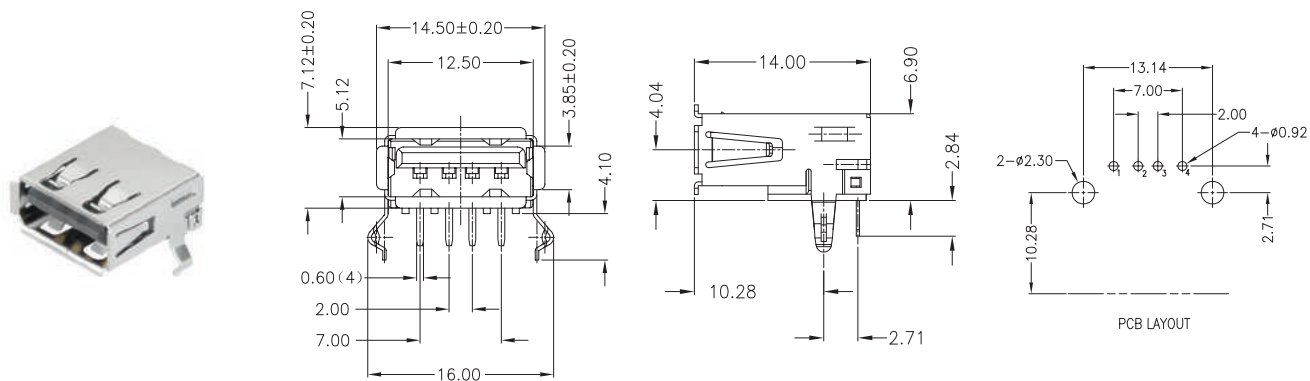

**Ordering data**

Type	Mounting onto the PCB	Plugging cycles	Performance-Category	Packaging	Qty.	Order No.
USB2.0A T1H 2.5N4 TY BK	THT solder connection	≥ 1500	480 Mbps	Tray (manual assembly)	100	<b>2563710000</b>



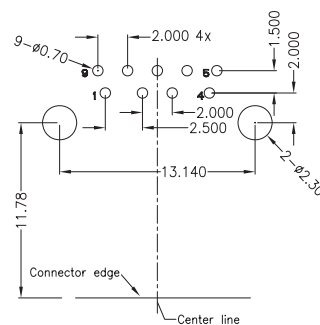
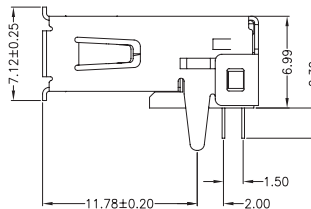
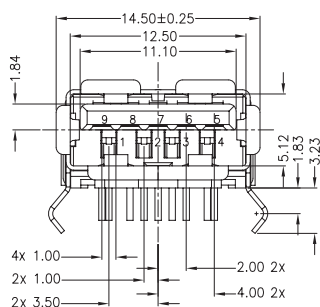

Ordering data

Type	Mounting onto the PCB	Plugging cycles	Performance-Category	Packaging	Qty.	Order No.
USB3.0A T1H 2.3N4 TY BL	THT solder connection	≥ 1500	5 Gbps	Tray (manual assembly)	104	2563550000





# OMNIMATE® Signal PCB terminals

<b>OMNIMATE® Signal PCB terminals</b>	Explanation	C.2
	Device Connectivity	C.10
	Quick selection	C.12
	Clamping yoke screw connection	C.14
	TOP screw connection	C.36
	Leaf spring screw connection	C.44
	PUSH IN spring connection	C.48
	Tension clamp connection	C.96

# OMNIMATE® Signal PCB terminals

## Flexible and versatile in pitches of between 3.5 mm and 9.52 mm for the wave soldering process

A wide variety of application requirements from the industrial automation and control fields are solved using the components from the comprehensive OMNIMATE® Signal PCB terminal range. You can find a suitable solution for almost any application, whether in terms of the conductor outlet direction, the pitch, the wire cross-section to be clamped, the required contact density through multi-level varieties or the sort of connection you want.

C

### Standard-compliant integration

Following relevant international guidelines/standards and Weidmüller's laboratory accreditation ensure highest quality standards for use globally.



### Screw connection system

The automatically counter-operating Weidmüller steel clamping yoke uses force generated by tightening the screw to open the upper thread. Settling of the connected wires and vibrations are compensated for and this guarantees a maintenance free operation. Subsequent tightening and maintenance of the screw is not needed.

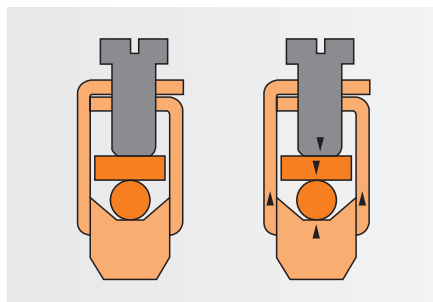

**Fire resistance**

The high-quality plastics used in many of the product families in the OMNIMATE® Signal product line meet the higher fire safety requirements according to the domestic appliance standard IEC 60335-1.



**Tension clamp connection system**

Simple and fast - the universal screw-less connector with a steel spring. Ideal for PCB installation terminals where it is important that the connections are secure. Single row, with or without an operating lever to open the terminal point with a wire cross-section of up to 2.5 mm<sup>2</sup>. Higher connector density with double, or triple level variations with a pitch of 5.08 mm and clamping range of up to 2.5 mm<sup>2</sup>.

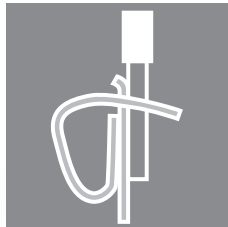

**Power reserve for safety**

The high performance insulating material WEMID with a continuous operating temperature of 120 °C for higher load currents and ambient temperatures. OMNIMATE® Signal PCB terminals already exceed the standard PA working temperature (100 °C) of many product families by 20 °K. This allows more power reserves and increased safety during temperature fluctuations or overloads.

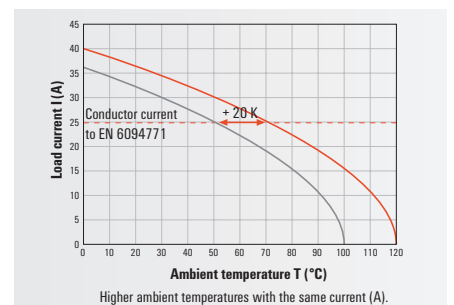

**PUSH IN connection system**

The innovative quick connector – simple, safe and economical. Direct insertion of solid-core wires and stranded wires with ferrules when used with the LSF-SMT series.

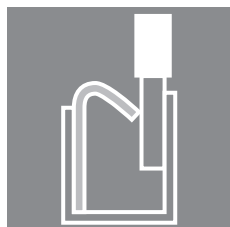



# OMNIMATE® Signal PCB terminals

## LSF-SMT spring connection in pitches of between 3.5 mm and 7.62 mm for the reflow soldering process (THR)

The innovative quick connector - simple, safe and economical. Its compact dimensions and surprising performance of 17.5 A / 800 V (IEC) means that the LSF-SMT meets the market push for miniaturisation. The OMNIMATE® Signal PCB terminals LSF-SMT offer a wide pitch range from 3.5 to 7.62 mm, in various conductor outlet directions (90°/135°/180°) to the PCB for connections of wire cross-sections of up to 1.5 mm<sup>2</sup>. The use of high-quality materials guarantees maximum cost effectiveness in the manufacturing of electronic assemblies.

### Form stability for the reflow soldering process

The high-temperature-resistant insulating material LCP used in the LSF-SMT range, is characterised by its form and dimensional stability. Due to low moisture absorption, the LSF-SMT can be immediately used in the Reflow THR soldering process without an extra drying phase. The uninterrupted production process from automated assembly to soldering is achieved saving you time and money.

### SMT/THR process compatible

The compact design and packaging (tape-on-reel) for automatic pick and place systems of SMT production lines reduces production costs of electronic components even further.

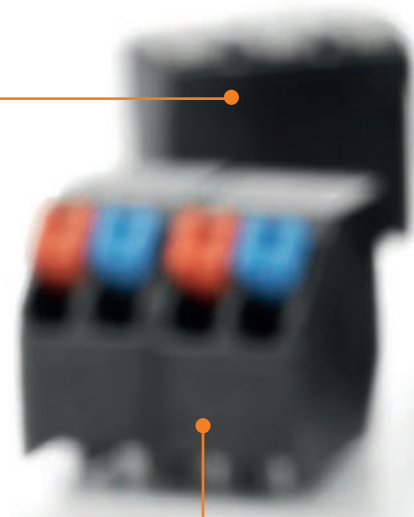

### Flexible processing

With a pin length of 3.5 mm for hand and wave soldering, or 1.5 mm for reflow soldering (THR), there are standard models available even for double sided assembled PCBs.

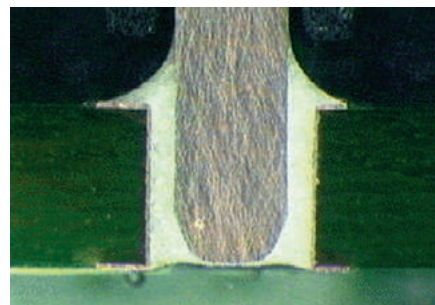

**Fire resistance**

The high-quality plastics used meet the higher fire safety requirements according to the domestic appliance standard IEC 60335-1.



**Design flexibility**

With the conductor outlet directions of 90°/135° and 180° over all pitches from 3.5 to 7.62 mm, all design options are possible.

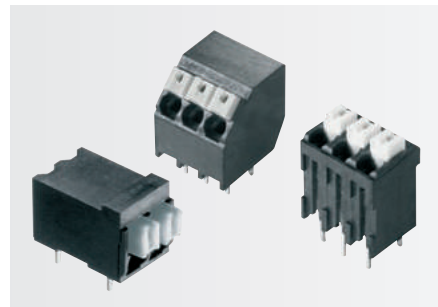

**Marking and mapping**

Terminal points can be distinctively marked with coloured push buttons or individual printing.



**Safe and efficient**

Solid conductors or wires with ferrules up to 1.5 mm<sup>2</sup> can be connected with the rapid spring-connection technology PUSH IN. The integrated push buttons are used for releasing. Amazingly simple and simply amazing in practice.

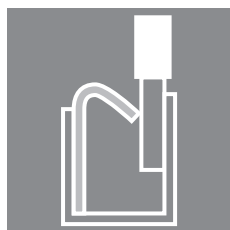

# OMNIMATE® Signal PCB terminals

## LSF-SMD 3.5/180 spring connection for the reflow soldering process (SMD)



The new LSF-SMD meets the demands for fully automatic PCB assembling as a surface-mounting device (SMD). Two SMD soldering pads per pole provide a high level of mechanical stability in accordance with IPC-A-610 class 2.

It is now possible for applications on glass based, ceramic based and aluminium compound based PCB's to also take advantage of PUSH IN technology. The existing portfolio of Weidmüller's reflow compatible LSF-SMT terminals with THR soldering has been expanded to include a real SMD variant.

The 3.5 mm pitch and the wire outlet direction of 180° allow a high packing density with a maximum wire cross section of 1.5 mm<sup>2</sup>.

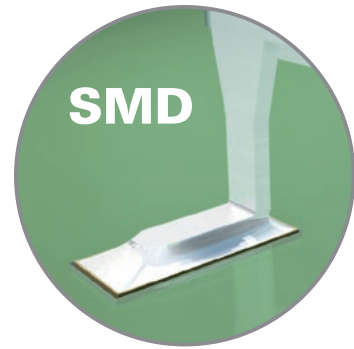

### Order a sample

Let yourself be convinced by the LSF-SMD features. Request a free sample using.



### Reliable processing

The LCP causes no formation of blisters and no predrying is required (MSL 1). Direct assembly with the SMT process is possible.

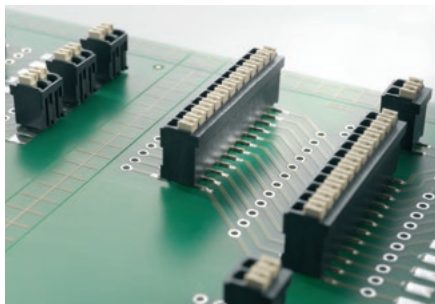

**Stable soldering connections**

With two solder pins per pole, the LSF-SMD PCB terminal is adequately attached to the circuit board and does not need an additional mounting flange.

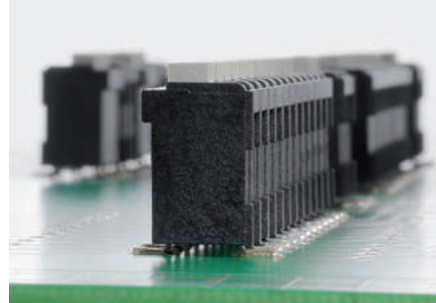

**Efficient assembly**

An efficient automatic assembly process is supported by the tape on reel packaging in standard tape widths. The optimised Pick and Place pads ensure that the pick and place process is safe and reliable.



**Fast wire connection method**

Safe contact connections up to 1.5 mm<sup>2</sup> with no tools needed: made possible by the proven PUSH IN connection system. The integrated release button is used to disconnect the cable in a simple and quick manner.

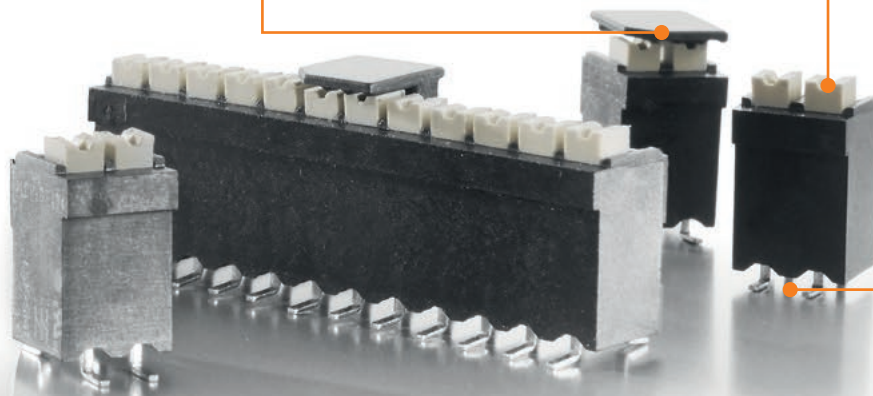
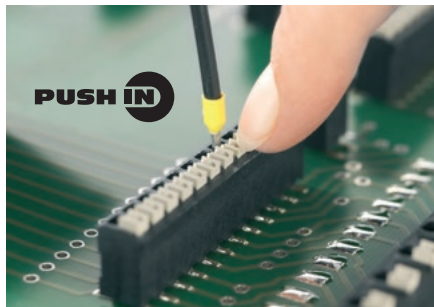

# OMNIMATE® Signal – PUSH IN PCB-terminal LMF

## Modern connectivity technology fulfilling the high demands of design up to a conductor cross section of 2.5 mm<sup>2</sup>

**Innovative developments in industrial devices means precision-fit connectivity for power supplies is needed. Your best choice is our new, compact LMF PCB terminals, which are compelling with their modern connectivity technology. Let's connect.**

The demands on PCB terminals in industrial device applications with a supply voltage of 250 V requires an extremely reliable wire connection contact and very safe electrical insulation materials.

C

Our response to this is the LMF with time saving PUSH IN spring connection technology, an integrated test point and a 90° or 180° wire outlet direction for different applications.

The Wemid insulation material allows the assembling of PCB terminals and continuous use in temperatures of up to 120 °C.

With these functions, the LMF meets the tough design requirements of industrial device connections. Let's connect.

### Integrated test point

The required maintenance and measurement can be carried out in a safe, reliable and convenient manner.

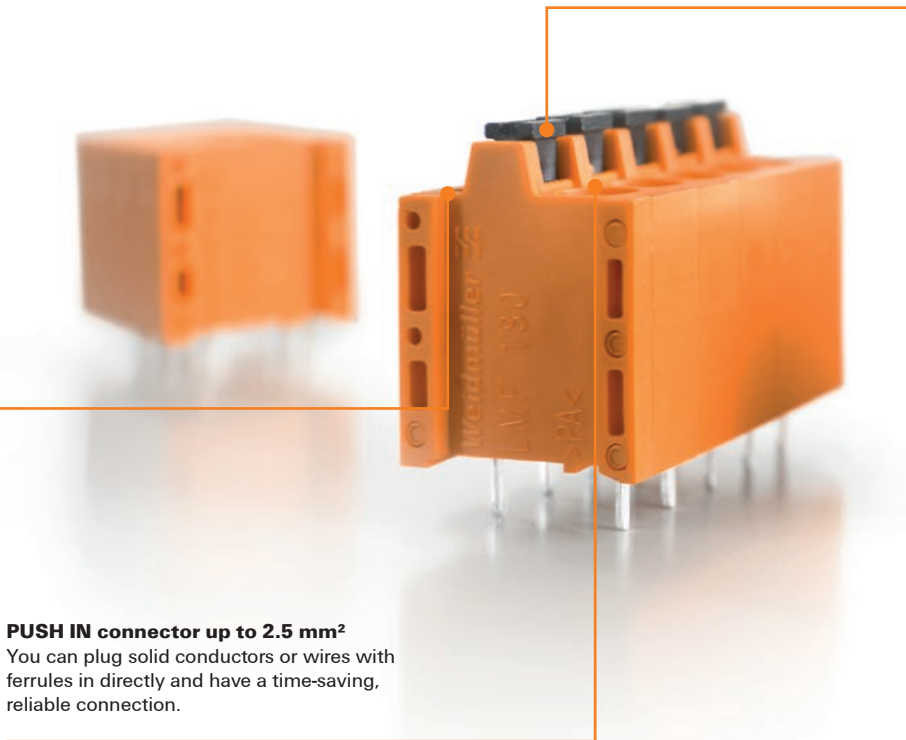

### PUSH IN connector up to 2.5 mm<sup>2</sup>

You can plug solid conductors or wires with ferrules in directly and have a time-saving, reliable connection.





**Wire outlet direction of 90° or 180°**

High flexibility in your design is given by options of wire outlet directions from above (180°) or the side (90°).

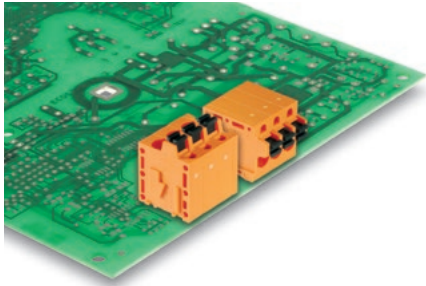

**Two solder pins per pole**

Benefit from the highly secure, current-carrying capacity and mechanical stability on the PCB board, without additional mounting elements.



**Optional “pusher”**

Select your preferred way of activating the PUSH IN spring connection: Depending on your choice, you open the contacts with the integrated “pusher” or by using a screwdriver.

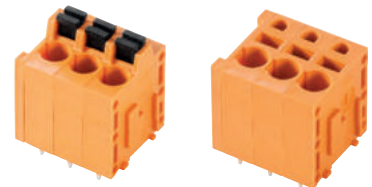

**120° C continuous use temperature**

In addition to fulfilling strict environmental standards, the Wemid insulation material also meets the requirement of maximum system reliability.

With a continuous use temperature of 120 °C, it exceeds the PA standard (100 °C) by 20 K.

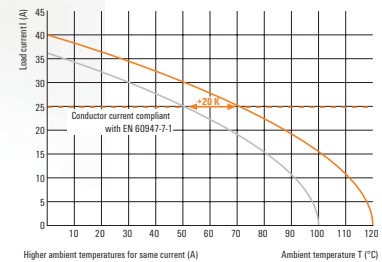

**Reliable functionality due to the “pusher”**

The optional push button provides a fast and exact wiring. By pressing the push button, the contact will open very quickly and easily.

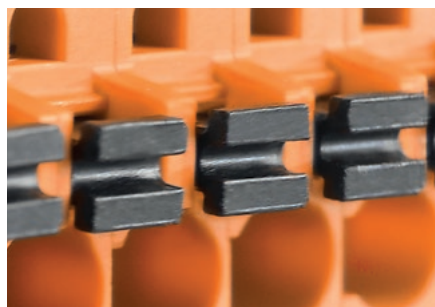

**Add-on programs of PUSH IN PCB terminals are the LSF product lines**

This terminal series for conductor cross-sections up to 1.5 mm<sup>2</sup> meets all the requirements of the automated assembly and reflow processes.

## The simple way to connect wires with cross-sections up to 1.5 mm<sup>2</sup> LS2HF with PUSH IN connection system on two connection levels

Ensuring compact dimensions through miniaturisation, while maintaining excellent functionality: these are the specific challenges faced when designing monitoring and I/O systems and devices in the field of building automation.

The new double-row OMNIMATE® Signal PCB terminal LS2HF meets both of these requirements at once thanks to the space-saving design and especially through the use of the time saving PUSH IN connection system. Optimised for wire cross-sections up to 1.5 mm<sup>2</sup> in a pitch dimension of 3.5 mm.

The LS2HF includes an integrated pusher for opening the contact in easiest way. An additional test point has also been integrated, making it easy to do necessary service measurements. The wire entry direction of 90° and the compact, double-row design of the LS2HF allows the simple integration into the front panel of a device.

### **PUSH IN connection**

Solid wires or wires with ferrules can be plugged directly thanks to the PUSH IN connection technology, which saves time and ensures a reliable connection.

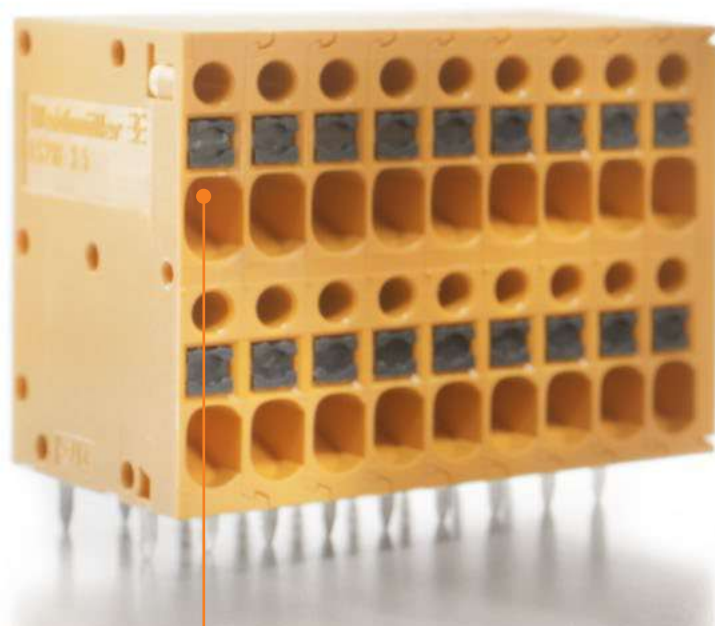
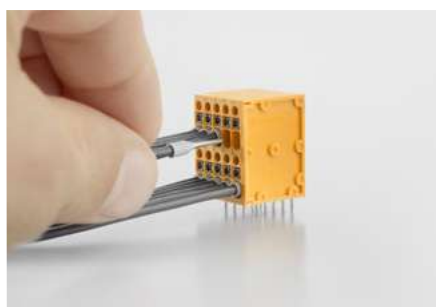

### **Integrated test point**

Necessary maintenance and measurements can be carried out in a safe, reliable and convenient manner.



**Reliable functionality**

The PUSH IN contact can be opened easily by pressing the push button in a particularly fast and unmistakable way.

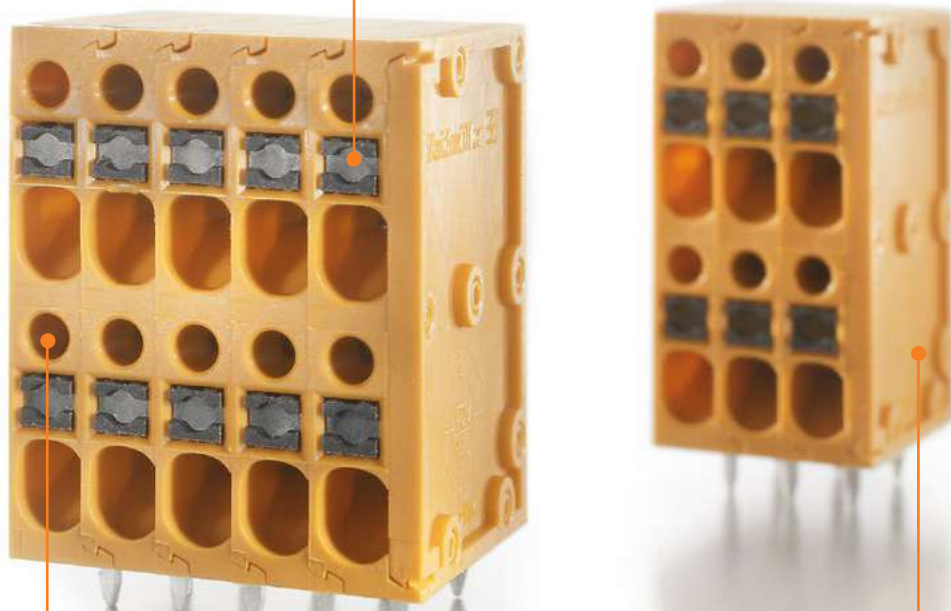
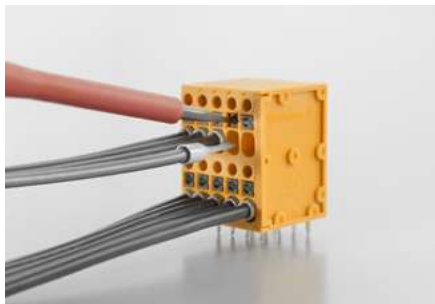

**High component density**

The compact design with PUSH IN connection system over two levels is perfectly suited for wire cross-sections up to 1.5 mm<sup>2</sup> in a pitch dimension of 3.5 mm.



**Your special advantages:**

**PCB connection within the smallest space**

For those looking for a compact and simple connection solution for optional installation in a front panel, the double-level LS2HF will not disappoint.



Quick and safe wiring with excellent performance: the space-saving LS2HF PCB terminal allows a perfect integration into the front panel of a device, e.g. with industrial control units and frequency converters

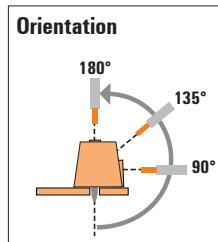

<http://www.OMNIMATE.net>

### PCB terminals

Type of connection	Clamping range	Type	IEC / UL	90°	135°	180°	
Screw	Clamping yoke ≤ 1.5 mm <sup>2</sup>	LM	IEC: 320 V/16 A/0.5 - 1.5 mm <sup>2</sup> UL: 300 V/10 A/AWG 28 - 14	●	●		
		LS	IEC: 630 V/17.5 A/0.08 - 1.5 mm <sup>2</sup> UL: 300 V/15 A/AWG 28 - 14	●			
		LM	IEC: 630 V/17.5 A/0.2 - 2.5 mm <sup>2</sup> UL: 300 V/15 A/AWG 24 - 14	●	●	●	
		LL	IEC: 500 V/32.5 A/0.5 - 6 mm <sup>2</sup> UL: 300 V/20 A/AWG 28 - 12	●		●	
	TOP	≤ 2.5 mm <sup>2</sup>	TOP1.5GS	IEC: 630 V/24 A/0.5 - 2.5 mm <sup>2</sup> UL: 300 V/10 A/AWG 26 - 14	●		●
		≤ 6.0 mm <sup>2</sup>	TOP4GS	IEC: 320 V/32 A/0.5 - 6 mm <sup>2</sup> UL: 300 V/30 A/AWG 26 - 10	●		●
		≤ 1.5 mm <sup>2</sup>	PS	IEC: 320 V/17.5 A/0.2 - 1.5 mm <sup>2</sup> UL: 300 V/10 A/AWG 28 - 16	●		
	Leaf spring	≤ 2.5 mm <sup>2</sup>	PM	IEC: 600 V/24 A/0.13 - 2.5 mm <sup>2</sup> UL: 300 V/15 A/AWG 26 - 14	●		
		Spring	≤ 1.5 mm <sup>2</sup>	LSF-SMT	IEC: 320 V/17.5 A/0.2 - 1.5 mm <sup>2</sup> UL: 300 V/12 A/AWG 24 - 16	●	●
	LSF-SMD			IEC: 320 V/17.5 A/0.2 - 1.5 mm <sup>2</sup> UL: 300 V/12 A/AWG 24 - 16			●
LMF(S)	IEC: 400 V/24 A/0.2 - 2.5 mm <sup>2</sup> UL: 300 V/10 A/AWG 26 - 12			●		●	
LS2HF	IEC: 400 V/17 A/0.2 - 1.5 mm <sup>2</sup> UL: 150 V/12.5 A/AWG 26 - 16			●			
Tension clamp ≤ 2.5 mm <sup>2</sup>	LMZF		IEC: 630 V/24 A/0.13 - 2.5 mm <sup>2</sup> UL: 300 V/15 A/AWG 26 - 14		●		



LM 3.5

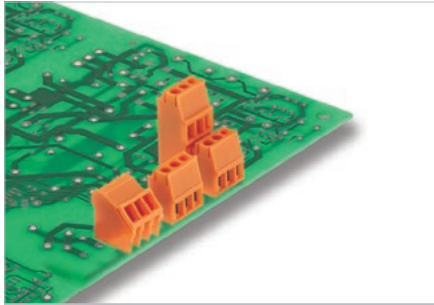

Small, compact PCB terminal with our proven clamping yoke screw connection in 3.5 mm pitch, suitable for wire cross-sections up to 1.5 mm<sup>2</sup>.

- Wire outlet direction: 90° or 135° version.
- 2- and 3-pole block construction – can be aligned together for higher pole counts.

Technical data

<b>In compliance with IEC 60664-1 / IEC 61984</b>			
Clamping range, max.	mm <sup>2</sup>	0.08...2.08	
<b>Solid core H05(07) V-U</b>	mm <sup>2</sup>	<b>0.5...1.5</b>	
Stranded H07 V-R			
Flexible H05(07) V-K	mm <sup>2</sup>	0.5...1.5	
Flexible with ferrule			
Ferrule with plastic collar	mm <sup>2</sup>	0.5...0.75	
Stripping length	mm	5	
Screwdriver blade	mm	0.4 x 2.5	
According to norm		DIN 5264	
Tightening torque range	Nm	0.2...0.25	
<b>Rated current, max.</b>	<b>A</b>	<b>16</b>	<b>14</b>
At ambient temperature		20°C	40°C
For conductor cross-section			
Overtoltage category		III	III II
Pollution severity		3	2 2
<b>Rated voltage</b>	<b>V</b>	<b>160</b>	<b>160 320</b>
Rated impulse voltage	kV	2.5	2.5 2.5
<b>UL / CUL (Use Group)</b>		<b>B</b>	<b>C D</b>
<b>Rated voltage</b>	<b>V</b>	<b>300</b>	<b>300</b>
<b>Rated current</b>	<b>A</b>	<b>10</b>	<b>10</b>
<b>AWG conductor</b>	<b>AWG</b>	<b>28-14</b>	
<b>CSA (Use Group)</b>		<b>B</b>	<b>C D</b>
Rated voltage	V	300	300
Rated current	A	10	10
AWG conductor	AWG	28-14	
<b>General data</b>			
Type of insulation material		PA	
UL 94 flammability rating		V-2	
Contact base material		Copper alloy	
Material of contact surface		tinned	
Pin dimensions = d	mm	1.0 x 0.6	
Solder eyelet Ø = D	mm	1.3	
Solder eyelet Ø tolerance	mm	+ 0,1	

Product data

IEC: 320 V / 16 A / 0.5 - 1.5 mm<sup>2</sup>  
 UL: 300 V / 10 A / AWG 28 - 14



For additional articles and information, refer to [catalog.weidmueller.com](http://catalog.weidmueller.com)

Note:

- Additional colours on request
- Rated current related to rated cross-section & min. No. of poles.
- Max. outer diameter of the conductor: 2.9 mm
- Wire end ferrule with plastic collar to DIN 46228/4
- P on drawing = pitch
- Rated data refer only to the component itself. Clearance and creepage distances to other components are to be designed in accordance with the relevant application standards.
- It is necessary to hold the insulating body of the one or two pole terminal when tightening the screw

LM 3.5/.. /90



Dimensioned drawing

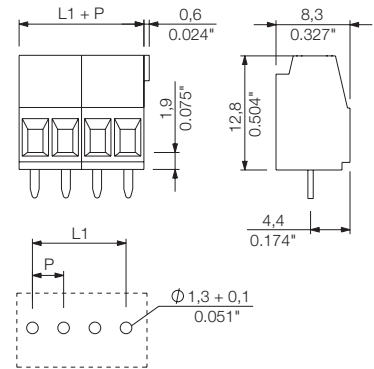

Ordering data

<b>Solder pin length</b>		3.2 mm		
<b>Colour</b>		Orange		
<b>Pitch</b>		3.50 mm		
Pol.	L1	(inch)	Qty.	Order No.
2	3.50	0.138	100	1667750000
3	7.00	0.276	100	1667770000
4	10.50	0.413	100	1845040000
5	14.00	0.551	100	1720250000
6	17.50	0.689	50	1845050000
7	21.00	0.827	50	1845060000
8	24.50	0.965	50	1845070000
9	28.00	1.102	50	1845080000
10	31.50	1.240	50	1845090000
11	35.00	1.378	50	1845100000
12	38.50	1.516	50	1845110000

Accessories

Note: Refer to the Accessories chapter for additional accessories.

Screwdriver		Order No.
	SDS 0.4X2.5X75	9009030000
	SDIS 0.4X2.5X75	9008370000

Representative deratings curve

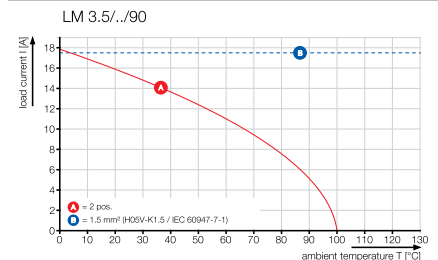

## LM 3.5

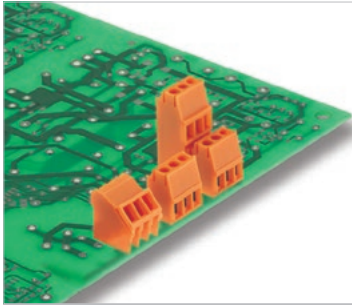

Small, compact PCB terminal with our proven clamping yoke screw connection in 3.5 mm pitch, suitable for wire cross-sections up to 1.5 mm<sup>2</sup>.

- Wire outlet direction: 90° or 135° version.
- 2- and 3-pole block construction – can be aligned together for higher pole counts.

## Product data

IEC: 320 V / 16 A / 0.5 - 1.5 mm<sup>2</sup>  
UL: 300 V / 10 A / AWG 28 - 14



For additional articles and information, refer to [catalog.weidmueller.com](http://catalog.weidmueller.com)

## Note:

- Additional colours on request
- Rated current related to rated cross-section & min. No. of poles.
- Max. outer diameter of the conductor: 2.9 mm
- Wire end ferrule with plastic collar to DIN 46228/4
- P on drawing = pitch
- Rated data refer only to the component itself. Clearance and creepage distances to other components are to be designed in accordance with the relevant application standards.
- It is necessary to hold the insulating body of the one or two pole terminal when tightening the screw

## LM 3.5/.. /135



## Dimensioned drawing

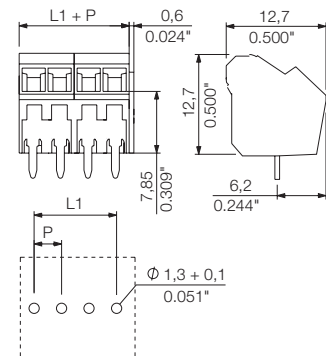



## Technical data

## In compliance with IEC 60664-1 / IEC 61984

Clamping range, max.	mm <sup>2</sup>	0.08...2.08	
<b>Solid core H05(07) V-U</b>	mm <sup>2</sup>	<b>0.5...1.5</b>	
Stranded H07 V-R			
Flexible H05(07) V-K	mm <sup>2</sup>	0.5...1.5	
Flexible with ferrule			
Ferrule with plastic collar	mm <sup>2</sup>	0.5...0.75	
Stripping length	mm	5	
Screwdriver blade	mm	0.4 x 2.5	
According to norm		DIN 5264	
Tightening torque range	Nm	0.2...0.25	
<b>Rated current, max.</b>	<b>A</b>	<b>16</b>	<b>14</b>
At ambient temperature		20°C	40°C
For conductor cross-section			
Overtoltage category		III	III
Pollution severity		3	2
<b>Rated voltage</b>	<b>V</b>	<b>160</b>	<b>160</b>
Rated impulse voltage	kV	2.5	2.5
<b>UL / CUL (Use Group)</b>		<b>B</b>	<b>C</b>
<b>Rated voltage</b>	<b>V</b>	<b>300</b>	<b>300</b>
<b>Rated current</b>	<b>A</b>	<b>10</b>	<b>10</b>
<b>AWG conductor</b>	<b>AWG</b>	<b>28-14</b>	
<b>CSA (Use Group)</b>		<b>B</b>	<b>C</b>
Rated voltage	V	300	300
Rated current	A	10	10
AWG conductor	AWG	28-14	
<b>General data</b>			
Type of insulation material		PA	
UL 94 flammability rating		V-2	
Contact base material		Copper alloy	
Material of contact surface		tinned	
Pin dimensions = d	mm	1.0 x 0.6	
Solder eyelet $\varnothing = D$	mm	1.3	
Solder eyelet $\varnothing$ tolerance	mm	+ 0,1	

## Accessories

Note: Refer to the Accessories chapter for additional accessories.

Screwdriver		Order No.
	SDS 0.4X2.5X75	<b>9009030000</b>
	SDIS 0.4X2.5X75	<b>9008370000</b>

## Ordering data

Solder pin length		3.2 mm		
Colour		Orange		
Pitch		3.50 mm		
Pol.	L1	(inch)	Qty.	Order No.
2	3.50	0.138	100	<b>1714980000</b>
3	7.00	0.276	100	<b>1715020000</b>
4	10.50	0.413	100	<b>1845220000</b>
5	14.00	0.551	50	<b>1845230000</b>
6	17.50	0.689	50	<b>1845240000</b>
7	21.00	0.827	50	<b>1845250000</b>
8	24.50	0.965	50	<b>1845260000</b>
9	28.00	1.102	50	<b>1845270000</b>
10	31.50	1.240	50	<b>1845280000</b>
11	35.00	1.378	50	<b>1845290000</b>
12	38.50	1.516	50	<b>1845300000</b>

## Representative deratings curve

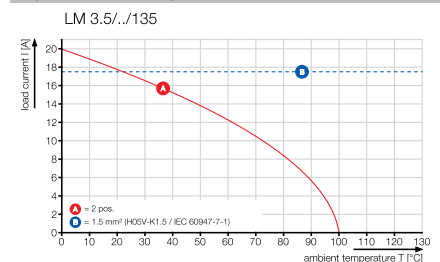

LM 3.5

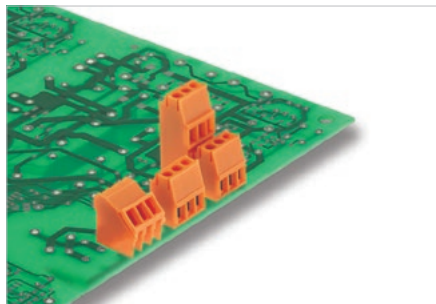

Small, compact PCB terminal with our proven clamping yoke screw connection in 3.5 mm pitch, suitable for wire cross-sections up to 1.5 mm<sup>2</sup>.

- Wire outlet direction: 90° or 135° version.
- 2- and 3-pole block construction – can be aligned together for higher pole counts.

Technical data

<b>In compliance with IEC 60664-1 / IEC 61984</b>			
Clamping range, max.	mm <sup>2</sup>	0.08...2.08	
<b>Solid core H05(07) V-U</b>	mm <sup>2</sup>	<b>0.5...1.5</b>	
Stranded H07 V-R			
Flexible H05(07) V-K	mm <sup>2</sup>	0.5...1.5	
Flexible with ferrule			
Ferrule with plastic collar	mm <sup>2</sup>	0.5...0.75	
Stripping length	mm	5	
Screwdriver blade	mm	0.4 x 2.5	
According to norm		DIN 5264	
Tightening torque range	Nm	0.2...0.25	
<b>Rated current, max.</b>	<b>A</b>	<b>13</b>	<b>11</b>
At ambient temperature		20°C	40°C
For conductor cross-section			
Overtoltage category		III	III II
Pollution severity		3	2 2
<b>Rated voltage</b>	<b>V</b>	<b>160</b>	<b>160 320</b>
Rated impulse voltage	kV	2.5	2.5 2.5
<b>UL / CUL (Use Group)</b>		<b>B</b>	<b>C D</b>
<b>Rated voltage</b>	<b>V</b>	<b>300</b>	<b>300</b>
<b>Rated current</b>	<b>A</b>	<b>10</b>	<b>10</b>
<b>AWG conductor</b>	<b>AWG</b>	<b>28-14</b>	
<b>CSA (Use Group)</b>		<b>B</b>	<b>C D</b>
Rated voltage	V	300	300
Rated current	A	10	10
AWG conductor	AWG	28-14	
<b>General data</b>			
Type of insulation material		PA	
UL 94 flammability rating		V-2	
Contact base material		Copper alloy	
Material of contact surface		tinned	
Pin dimensions = d	mm	1.0 x 0.6	
Solder eyelet Ø = D	mm	1.3	
Solder eyelet Ø tolerance	mm	+ 0,1	

Product data

IEC: 320 V / 13 A / 0.5 - 1.5 mm<sup>2</sup>  
 UL: 300 V / 10 A / AWG 28 - 14



For additional articles and information, refer to [catalog.weidmueller.com](http://catalog.weidmueller.com)

Note:

- Additional colours on request
- Rated current related to rated cross-section & min. No. of poles.
- Max. outer diameter of the conductor: 2.9 mm
- Wire end ferrule with plastic collar to DIN 46228/4
- P on drawing = pitch
- Rated data refer only to the component itself. Clearance and creepage distances to other components are to be designed in accordance with the relevant application standards.
- It is necessary to hold the insulating body of the one or two pole terminal when tightening the screw

LM1N 3.5/./90



Dimensioned drawing

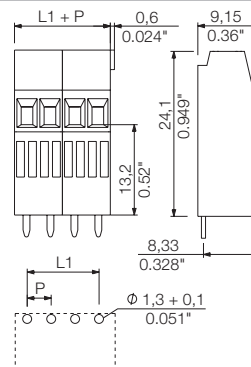

Ordering data

<b>Solder pin length</b>		3.2 mm		
<b>Colour</b>		Orange		
<b>Pitch</b>		3.50 mm		
<b>Pol.</b>	<b>L1</b>	<b>(inch)</b>	<b>Qty.</b>	<b>Order No.</b>
2	3.50	0.138	100	1716710000
3	7.00	0.276	100	1716720000

Accessories

Note: Refer to the Accessories chapter for additional accessories.

Screwdriver		Order No.
	SDS 0.4X2.5X75	9009030000
	SDIS 0.4X2.5X75	9008370000

Representative deratings curve

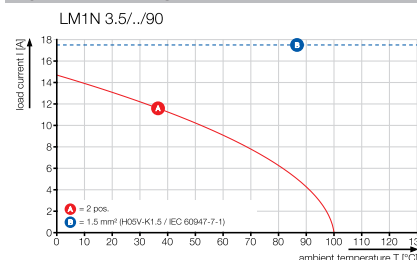



## LM 3.5

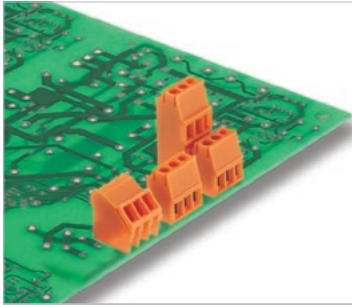

Small, compact PCB terminal with our proven clamping yoke screw connection in 3.5 mm pitch, suitable for wire cross-sections up to 1.5 mm<sup>2</sup>.

- Wire outlet direction: 90° or 135° version.
- 2- and 3-pole block construction – can be aligned together for higher pole counts.

## Technical data

## In compliance with IEC 60664-1 / IEC 61984

Clamping range, max.	mm <sup>2</sup>	0.08...2.08	
<b>Solid core H05(07) V-U</b>	mm <sup>2</sup>	<b>0.5...1.5</b>	
Stranded H07 V-R			
Flexible H05(07) V-K	mm <sup>2</sup>	0.5...1.5	
Flexible with ferrule			
Ferrule with plastic collar	mm <sup>2</sup>	0.5...0.75	
Stripping length	mm	5	
Screwdriver blade	mm	0.4 x 2.5	
According to norm		DIN 5264	
Tightening torque range	Nm	0.2...0.2	
<b>Rated current, max.</b>	<b>A</b>	<b>13</b>	<b>11</b>
At ambient temperature		20°C	40°C
For conductor cross-section			
Overtoltage category		III	III II
Pollution severity		3	2 2
<b>Rated voltage</b>	<b>V</b>	<b>160</b>	<b>160 320</b>
Rated impulse voltage	kV	2.5	2.5 2.5
<b>UL / CUL (Use Group)</b>		<b>B</b>	<b>C D</b>
<b>Rated voltage</b>	<b>V</b>	<b>300</b>	<b>300</b>
<b>Rated current</b>	<b>A</b>	<b>10</b>	<b>10</b>
<b>AWG conductor</b>	<b>AWG</b>	<b>28-14</b>	
<b>CSA (Use Group)</b>		<b>B</b>	<b>C D</b>
Rated voltage	V	300	300
Rated current	A	10	10
AWG conductor	AWG	28-14	

## General data

Type of insulation material		PA
UL 94 flammability rating		V-2
Contact base material		Copper alloy
Material of contact surface		tinned
Pin dimensions = d	mm	1.0 x 0.6
Solder eyelet Ø = D	mm	1.3
Solder eyelet Ø tolerance	mm	+ 0,1

## Product data

IEC: 320 V / 13 A / 0.5 - 1.5 mm<sup>2</sup>  
UL: 300 V / 10 A / AWG 28 - 14



For additional articles and information, refer to [catalog.weidmuller.com](http://catalog.weidmuller.com)

## Note:

- Additional colours on request
- Rated current related to rated cross-section & min. No. of poles.
- Max. outer diameter of the conductor: 2.9 mm
- Wire end ferrule with plastic collar to DIN 46228/4
- P on drawing = pitch
- Rated data refer only to the component itself. Clearance and creepage distances to other components are to be designed in accordance with the relevant application standards.

## LM2N 3.5/./90

multi-row



## Dimensioned drawing

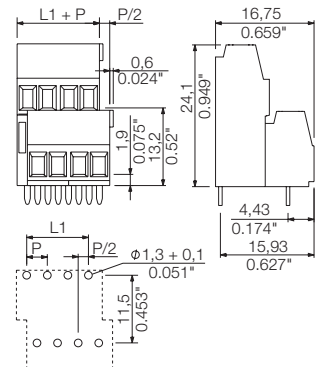

## Ordering data

Solder pin length		3.2 mm		
Colour		Orange		
Pitch		3.50 mm		
Pol.	L1	(inch)	Qty.	Order No.
4	3.50	0.138	100	1703700000
6	7.00	0.276	100	1703710000
8	10.50	0.413	100	1703720000
10	14.00	0.551	50	1703730000
12	17.50	0.689	50	1703740000
14	21.00	0.827	50	1703750000
16	24.50	0.965	50	1703760000
18	28.00	1.102	50	1703770000
20	31.50	1.240	50	1703780000
22	35.00	1.378	25	1703790000
24	38.50	1.516	25	1703800000
26	42.00	1.654	25	1703810000
28	45.50	1.791	25	1703820000
30	49.00	1.929	25	1703830000
32	52.50	2.067	25	1703840000
34	56.00	2.205	25	1703850000
36	59.50	2.343	25	1703860000
38	63.00	2.480	25	1703870000
40	66.50	2.618	25	1703880000
42	70.00	2.756	20	1703890000
44	73.50	2.894	20	1703900000
46	77.00	3.031	20	1703910000
48	80.50	3.169	20	1703920000

## Representative deratings curve

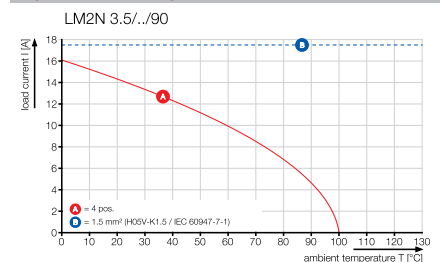

LS 5.08

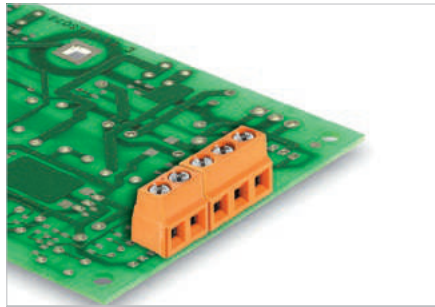

Small, compact PCB terminal with our proven clamping yoke screw connection in 5.08 mm pitch, suitable for wire cross-sections up to 1.5 mm<sup>2</sup>.

- Increased derating reserves through the use of WEMID insulating material
- Wire outlet direction: 90° version
- 2- and 3-pole block construction – can be aligned together for higher pole counts.

Technical data

In compliance with IEC 60664-1 / IEC 61984

Clamping range, max.	mm <sup>2</sup>	0.08...1.5	
<b>Solid core H05(07) V-U</b>	mm <sup>2</sup>	<b>0.08...1.5</b>	
Stranded H07 V-R			
Flexible H05(07) V-K	mm <sup>2</sup>	0.08...1.5	
Flexible with ferrule	mm <sup>2</sup>	0.25...1.5	
Ferrule with plastic collar	mm <sup>2</sup>	0.25...1.5	
Stripping length	mm	6	
Screwdriver blade	mm	0.6 x 3.5	
According to norm		DIN 5264	
Tightening torque range	Nm	0.4...0.5	
<b>Rated current, max.</b>	<b>A</b>	<b>17.5</b>	<b>17.5</b>
At ambient temperature		20°C	40°C
For conductor cross-section			
Overtoltage category		III	III II
Pollution severity		3	2 2
<b>Rated voltage</b>	<b>V</b>	<b>250</b>	<b>320 630</b>
Rated impulse voltage	kV	4	4 4
<b>UL / CUL (Use Group)</b>		<b>B</b>	<b>C D</b>
<b>Rated voltage</b>	<b>V</b>	<b>300</b>	<b>300</b>
<b>Rated current</b>	<b>A</b>	<b>15</b>	<b>10</b>
<b>AWG conductor</b>	<b>AWG</b>	<b>28-14</b>	
<b>CSA (Use Group)</b>		<b>B</b>	<b>C D</b>
Rated voltage	V	300	300
Rated current	A	20	10
AWG conductor	AWG	28-14	
<b>General data</b>			
Type of insulation material		Wemid (PA)	
UL 94 flammability rating		V-0	
Contact base material		Copper alloy	
Material of contact surface		tinned	
Pin dimensions = d	mm	0.5 x 1.0	
Solder eyelet Ø = D	mm	1.3	
Solder eyelet Ø tolerance	mm	+ 0,1	

Product data

IEC: 630 V / 17.5 A / 0.08 - 1.5 mm<sup>2</sup>  
 UL: 300 V / 15 A / AWG 28 - 14



For additional articles and information, refer to [catalog.weidmueller.com](http://catalog.weidmueller.com)

Note:

- Rated current related to rated cross-section & min. No. of poles.
- Wire end ferrule without plastic collar to DIN 46228/1
- Wire end ferrule with plastic collar to DIN 46228/4
- P on drawing = pitch
- Rated data refer only to the component itself. Clearance and creepage distances to other components are to be designed in accordance with the relevant application standards.
- It is necessary to hold the insulating body of the one or two pole terminal when tightening the screw

LS 5.08/./90



Dimensioned drawing

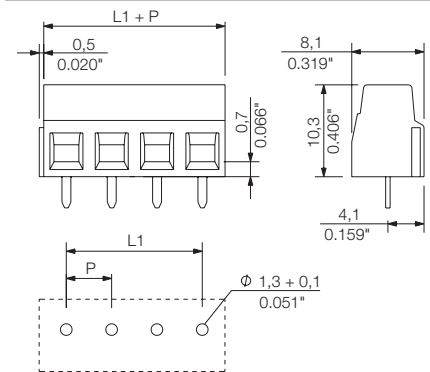

Ordering data

<b>Solder pin length</b>		3.5 mm		
<b>Colour</b>		Orange		
<b>Pitch</b>		5.08 mm		
Pol.	L1	(inch)	Qty.	Order No.
2	5.08	0.200	100	1912520000
3	10.16	0.400	100	1912530000
4	15.24	0.600	100	1912540000
5	20.32	0.800	100	1912560000
6	25.40	1.000	100	1912570000
7	30.48	1.200	100	1912850000
8	35.56	1.400	100	1912890000
9	40.64	1.600	100	1912900000
10	45.72	1.800	100	1912910000
11	50.80	2.000	100	1912930000
12	55.88	2.200	100	1912940000

Accessories

Note: Refer to the Accessories chapter for additional accessories.

Screwdriver		Order No.
	SDS 0.6X3.5X100	9008330000
	SDIS 0.6X3.5X100	9008390000

Representative deratings curve

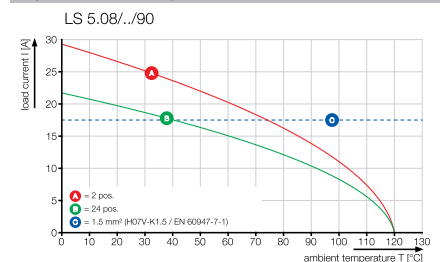



LM 5.00

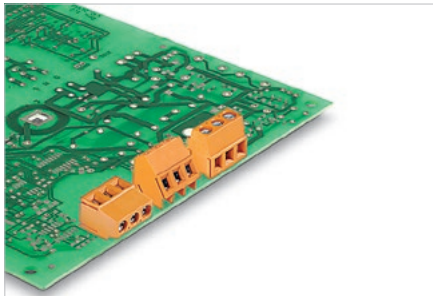

Single-row PCB terminal with our proven clamping-yoke screw connection in 5.00 mm pitch, suitable for wire cross-sections up to 2.5 mm<sup>2</sup>.

- Increased derating reserves through the use of WEMID insulating material
- Wire outlet direction: 90°, 135° or 180° version.
- 2- and 3-pole block construction – can be aligned together for higher pole counts.

Technical data

In compliance with IEC 60664-1 / IEC 61984			
Clamping range, max.	mm <sup>2</sup>	0.2...2.5	
<b>Solid core H05(07) V-U</b>	<b>mm<sup>2</sup></b>	<b>0.2...2.5</b>	
Stranded H07 V-R			
Flexible H05(07) V-K	mm <sup>2</sup>	0.2...2.5	
Flexible with ferrule	mm <sup>2</sup>	0.25...1.5	
Ferrule with plastic collar	mm <sup>2</sup>	0.25...1.5	
Stripping length	mm	6	
Screwdriver blade	mm	0.6 x 3.5	
According to norm		DIN 5264	
Tightening torque range	Nm	0.4...0.5	
<b>Rated current, max.</b>	<b>A</b>	<b>17.5</b>	<b>17.5</b>
At ambient temperature	20°C	40°C	
For conductor cross-section			
Overtoltage category		III	III II
Pollution severity		3	2 2
<b>Rated voltage</b>	<b>V</b>	<b>250</b>	<b>320 630</b>
Rated impulse voltage	kV	4	4 4
<b>UL / CUL (Use Group)</b>		<b>B</b>	<b>C D</b>
<b>Rated voltage</b>	<b>V</b>	<b>300</b>	<b>300</b>
<b>Rated current</b>	<b>A</b>	<b>15</b>	<b>10</b>
<b>AWG conductor</b>	<b>AWG</b>	<b>24-14</b>	
<b>CSA (Use Group)</b>		<b>B</b>	<b>C D</b>
Rated voltage	V	300	300
Rated current	A	18	10
AWG conductor	AWG	24-14	
General data			
Type of insulation material		Wemid (PA)	
UL 94 flammability rating		V-0	
Contact base material		Copper alloy	
Material of contact surface		tinned	
Pin dimensions = d	mm	0.95 x 0.8	
Solder eyelet Ø = D	mm	1.3	
Solder eyelet Ø tolerance	mm	+ 0,1	

Product data

IEC: 630 V / 17.5 A / 0.2 - 2.5 mm<sup>2</sup>  
 UL: 300 V / 15 A / AWG 24 - 14



For additional articles and information, refer to [catalog.weidmueller.com](http://catalog.weidmueller.com)

Note:

- Rated current related to rated cross-section & min. No. of poles.
- Wire end ferrule without plastic collar to DIN 46228/1
- Wire end ferrule with plastic collar to DIN 46228/4
- P on drawing = pitch
- Rated data refer only to the component itself. Clearance and creepage distances to other components are to be designed in accordance with the relevant application standards.
- It is necessary to hold the insulating body of the one or two pole terminal when tightening the screw

LM 5.00/..90



Dimensioned drawing

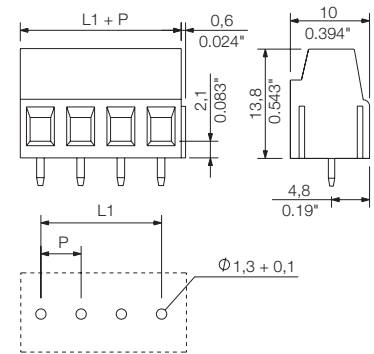

Accessories

Note: Refer to the Accessories chapter for additional accessories.

Screwdriver		Order No.
	SDS 0.6X3.5X100	9008330000
	SDIS 0.6X3.5X100	9008390000

Ordering data

Solder pin length		3.5 mm		
Colour		Orange		
Pitch	5.00 mm			
Pol.	L1	(inch)	Qty.	Order No.
2	5.00	0.197	500	1715310000
3	10.00	0.394	500	1715320000
4	15.00	0.591	50	1821490000
5	20.00	0.787	50	1845310000
6	25.00	0.984	50	1845320000
7	30.00	1.181	50	1845330000
8	35.00	1.378	50	1845340000
9	40.00	1.575	50	1845350000
10	45.00	1.772	50	1845360000
11	50.00	1.969	50	1845370000
12	55.00	2.165	50	1845380000
13	60.00	2.362	50	1234050000
14	65.00	2.559	50	1234070000
15	70.00	2.756	50	1234090000
16	75.00	2.953	50	1234120000
17	80.00	3.150	50	1234130000
18	85.00	3.346	50	1234140000
19	90.00	3.543	50	1234150000
20	95.00	3.740	50	1234170000
21	100.00	3.937	50	1234180000
22	105.00	4.134	50	1234190000
23	110.00	4.331	50	1234200000
24	115.00	4.528	50	1234210000

Representative deratings curve

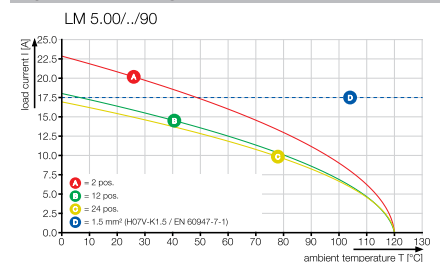

LM 5.00/./135



Dimensioned drawing

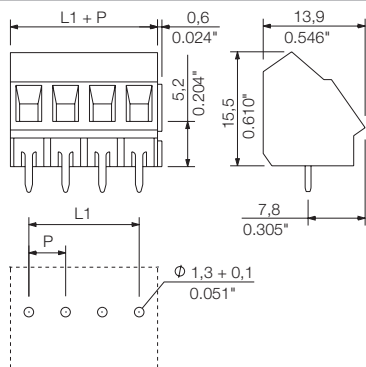

Ordering data

Solder pin length		3.5 mm	
Colour		Orange	
Pitch		5.00 mm	
Pol.	L1	(inch)	Qty. Order No.
2	5.00	0.197	500 1715350000
3	10.00	0.394	500 1715360000
4	15.00	0.591	50 1845390000
5	20.00	0.787	50 1845400000
6	25.00	0.984	50 1845410000
7	30.00	1.181	50 1845420000
8	35.00	1.378	50 1845430000
9	40.00	1.575	50 1845440000
10	45.00	1.772	50 1845450000
11	50.00	1.969	50 1845460000
12	55.00	2.165	50 1845470000
13	60.00	2.362	50 1233910000
14	65.00	2.559	50 1233920000
15	70.00	2.756	50 1233930000
16	75.00	2.953	50 1233940000
17	80.00	3.150	50 1233950000
18	85.00	3.346	50 1233970000
19	90.00	3.543	50 1233980000
20	95.00	3.740	50 1233990000
21	100.00	3.937	50 1234010000
22	105.00	4.134	50 1234020000
23	110.00	4.331	50 1234030000
24	115.00	4.528	50 1234040000

LM 5.00/./180



Dimensioned drawing

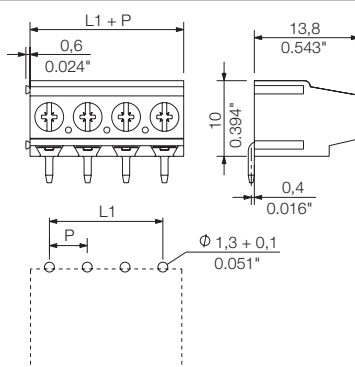

Ordering data

Solder pin length		3.5 mm	
Colour		Orange	
Pitch		5.00 mm	
Pol.	L1	(inch)	Qty. Order No.
2	5.00	0.197	500 1715330000
3	10.00	0.394	500 1715340000
4	15.00	0.591	50 1234230000
5	20.00	0.787	50 1234240000
6	25.00	0.984	50 1234250000
7	30.00	1.181	50 1234270000
8	35.00	1.378	50 1234280000
9	40.00	1.575	50 1234290000
10	45.00	1.772	50 1234310000
11	50.00	1.969	50 1234320000
12	55.00	2.165	50 1234330000
13	60.00	2.362	50 1234340000
14	65.00	2.559	50 1234350000
15	70.00	2.756	50 1234370000
16	75.00	2.953	50 1234380000
17	80.00	3.150	50 1234390000
18	85.00	3.346	50 1234400000
19	90.00	3.543	50 1234410000
20	95.00	3.740	50 1234420000
21	100.00	3.937	50 1234430000
22	105.00	4.134	50 1234440000
23	110.00	4.331	50 1234450000
24	115.00	4.528	50 1234470000

Additional deratings curves

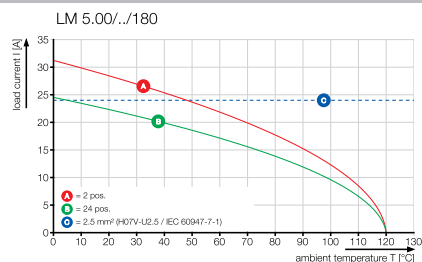
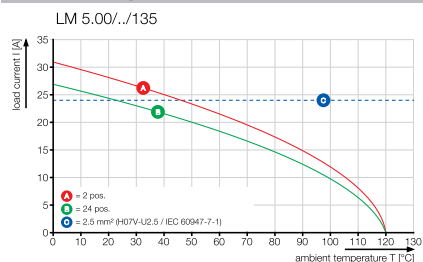

LM 5.08

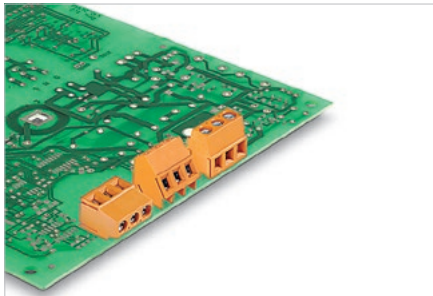

Single-row PCB terminal with our proven clamping-yoke screw connection in 5.08 mm pitch, suitable for wire cross-sections up to 2.5 mm<sup>2</sup>.

- Increased derating reserves through the use of WEMID insulating material
- Wire outlet direction: 90°, 135° or 180° version.
- 2- and 3-pole block construction – can be aligned together for higher pole counts.

Technical data

In compliance with IEC 60664-1 / IEC 61984			
Clamping range, max.	mm <sup>2</sup>	0.2...2.5	
<b>Solid core H05(07) V-U</b>	<b>mm<sup>2</sup></b>	<b>0.2...2.5</b>	
Stranded H07 V-R			
Flexible H05(07) V-K	mm <sup>2</sup>	0.2...2.5	
Flexible with ferrule	mm <sup>2</sup>	0.25...1.5	
Ferrule with plastic collar	mm <sup>2</sup>	0.25...1.5	
Stripping length	mm	6	
Screwdriver blade	mm	0.6 x 3.5	
According to norm		DIN 5264	
Tightening torque range	Nm	0.4...0.5	
<b>Rated current, max.</b>	<b>A</b>	<b>17.5</b>	<b>17.5</b>
At ambient temperature		20°C	40°C
For conductor cross-section			
Overtoltage category		III	III II
Pollution severity		3	2 2
<b>Rated voltage</b>	<b>V</b>	<b>250</b>	<b>320 630</b>
Rated impulse voltage	kV	4	4 4
<b>UL / CUL (Use Group)</b>		<b>B</b>	<b>C D</b>
<b>Rated voltage</b>	<b>V</b>	<b>300</b>	<b>300</b>
<b>Rated current</b>	<b>A</b>	<b>15</b>	<b>10</b>
<b>AWG conductor</b>	<b>AWG</b>	<b>24-14</b>	
<b>CSA (Use Group)</b>		<b>B</b>	<b>C D</b>
Rated voltage	V	300	300
Rated current	A	18	10
AWG conductor	AWG	24-14	
General data			
Type of insulation material		Wemid (PA)	
UL 94 flammability rating		V-0	
Contact base material		Copper alloy	
Material of contact surface		tinned	
Pin dimensions = d	mm	0.95 x 0.8	
Solder eyelet Ø = D	mm	1.3	
Solder eyelet Ø tolerance	mm	+ 0,1	

5.08

90°

2.5 mm<sup>2</sup>

Product data

IEC: 630 V / 17.5 A / 0.2 - 2.5 mm<sup>2</sup>  
 UL: 300 V / 15 A / AWG 24 - 14



For additional articles and information, refer to [catalog.weidmueller.com](http://catalog.weidmueller.com)

Note:

- Rated current related to rated cross-section & min. No. of poles.
- Wire end ferrule without plastic collar to DIN 46228/1
- Wire end ferrule with plastic collar to DIN 46228/4
- P on drawing = pitch
- Rated data refer only to the component itself. Clearance and creepage distances to other components are to be designed in accordance with the relevant application standards.

LM 5.08/..90



Dimensioned drawing

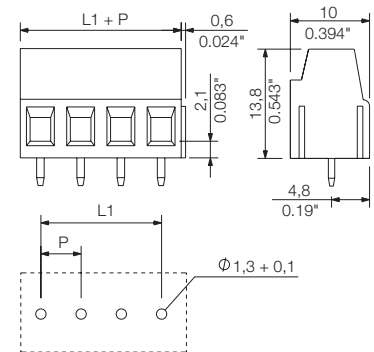

Accessories

Note: Refer to the Accessories chapter for additional accessories.

Screwdriver		Order No.
	SDS 0.6X3.5X100	9008330000
	SDIS 0.6X3.5X100	9008390000

Ordering data

Solder pin length		3.5 mm		
Colour		Orange		
Pitch		5.08 mm		
Pol.	L1	(inch)	Qty.	Order No.
2	5.08	0.200	500	1716080000
3	10.16	0.400	500	1716090000
4	15.24	0.600	50	9994130000
5	20.32	0.800	50	9994140000
6	25.40	1.000	50	9994150000
7	30.48	1.200	50	9994160000
8	35.56	1.400	50	9994170000
9	40.64	1.600	50	9994180000
10	45.72	1.800	50	9994190000
11	50.80	2.000	50	9994200000
12	55.88	2.200	50	9994210000
13	60.96	2.400	50	9994220000
14	66.04	2.600	50	9994230000
15	71.12	2.800	50	9994240000
16	76.20	3.000	50	9994250000
17	81.28	3.200	50	9994260000
18	86.36	3.400	50	9994270000
19	91.44	3.600	50	9994280000
20	96.52	3.800	50	9994290000
21	101.60	4.000	50	9994300000
22	106.68	4.200	50	9994310000
23	111.76	4.400	50	9994320000
24	116.84	4.600	50	9994330000

Representative deratings curve

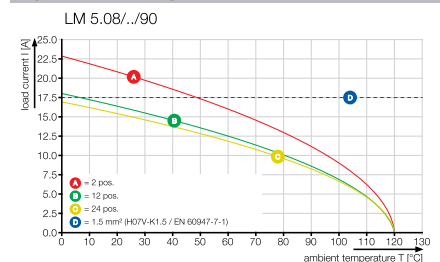

LM 5.08../135



Dimensioned drawing

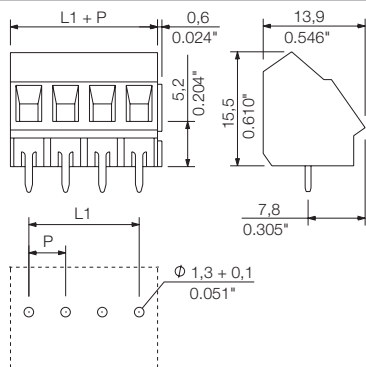

Ordering data

Solder pin length		3.5 mm	
Colour		Orange	
Pitch		5.08 mm	
Pol.	L1 (inch)	Qty.	Order No.
2	5.08	500	1716120000
3	10.16	500	1716130000
4	15.24	50	9994550000
5	20.32	50	9994560000
6	25.40	50	9994570000
7	30.48	50	9994580000
8	35.56	50	9994590000
9	40.64	50	9994600000
10	45.72	50	9994610000
11	50.80	50	9994620000
12	55.88	50	9994630000
13	60.96	50	9994640000
14	66.04	50	9994650000
15	71.12	50	9994660000
16	76.20	50	9994670000
17	81.28	50	9994680000
18	86.36	50	9994690000
19	91.44	50	9994700000
20	96.52	50	9994710000
21	101.60	50	9994720000
22	106.68	50	9994730000
23	111.76	50	9994740000
24	116.84	50	9994750000

LM 5.08../180



Dimensioned drawing

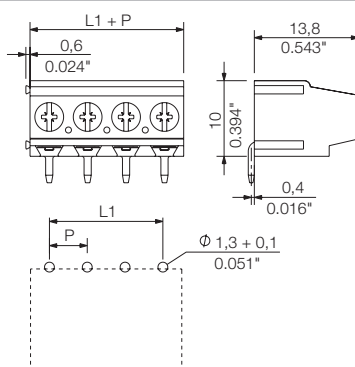

Ordering data

Solder pin length		3.5 mm	
Colour		Orange	
Pitch		5.08 mm	
Pol.	L1 (inch)	Qty.	Order No.
2	5.08	500	1716100000
3	10.16	500	1716110000
4	15.24	50	9994970000
5	20.32	50	9994980000
6	25.40	50	9994990000
7	30.48	50	9995000000
8	35.56	50	9995010000
9	40.64	50	9995020000
10	45.72	50	9995030000
11	50.80	50	9995040000
12	55.88	50	9995050000
13	60.96	50	9995060000
14	66.04	50	9995070000
15	71.12	50	9995080000
16	76.20	50	9995090000
17	81.28	50	9995100000
18	86.36	50	9995110000
19	91.44	50	9995120000
20	96.52	50	9995130000
21	101.60	50	9995140000
22	106.68	50	9995150000
23	111.76	50	9995210000
24	116.84	50	9995220000

Additional deratings curves

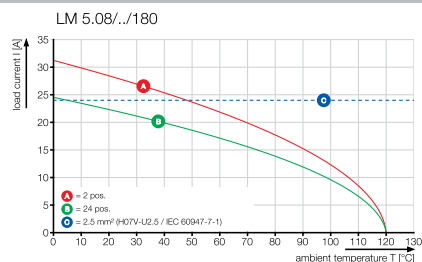
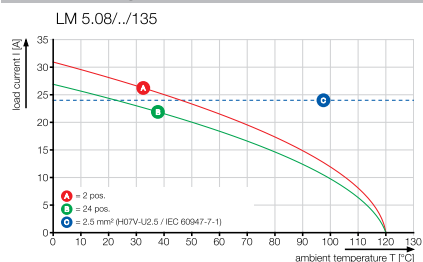

LM 5.08, multi-level

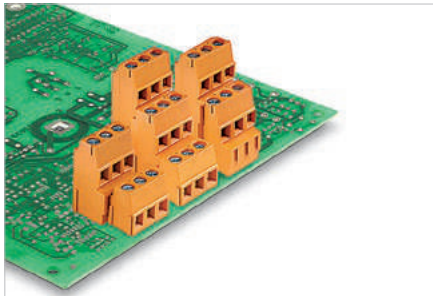

Multi-level PCB terminal with our proven clamping yoke screw connection in 5.08 mm pitch, suitable for wire cross-sections up to 2.5 mm<sup>2</sup>.

- Increased derating reserves through the use of WEMID insulating material
- Wire outlet direction: 90° version
- Block construction – can be aligned together for higher pole counts.

Technical data

In compliance with IEC 60664-1 / IEC 61984			
Clamping range, max.	mm <sup>2</sup>	0.2...2.5	
<b>Solid core H05(07) V-U</b>	<b>mm<sup>2</sup></b>	<b>0.2...2.5</b>	
Stranded H07 V-R			
Flexible H05(07) V-K	mm <sup>2</sup>	0.2...2.5	
Flexible with ferrule	mm <sup>2</sup>	0.25...1.5	
Ferrule with plastic collar	mm <sup>2</sup>	0.25...1.5	
Stripping length	mm	6	
Screwdriver blade	mm	0.6 x 3.5	
According to norm		DIN 5264	
Tightening torque range	Nm	0.4...0.5	
<b>Rated current, max.</b>	<b>A</b>	<b>17.5</b>	<b>17.5</b>
At ambient temperature		20°C	40°C
For conductor cross-section			
Overvoltage category		III	III II
Pollution severity		3	2 2
<b>Rated voltage</b>	<b>V</b>	<b>250</b>	<b>320 630</b>
Rated impulse voltage	kV	4	4 4
<b>UL / CUL (Use Group)</b>		<b>B</b>	<b>C D</b>
<b>Rated voltage</b>	<b>V</b>	<b>300</b>	<b>300</b>
<b>Rated current</b>	<b>A</b>	<b>15</b>	<b>10</b>
<b>AWG conductor</b>	<b>AWG</b>	<b>24-14</b>	
<b>CSA (Use Group)</b>		<b>B</b>	<b>C D</b>
Rated voltage	V	300	300
Rated current	A	18	10
AWG conductor	AWG	24-14	
<b>General data</b>			
Type of insulation material		Wemid (PA)	
UL 94 flammability rating		V-0	
Contact base material		Copper alloy	
Material of contact surface		tinned	
Pin dimensions = d	mm	0.95 x 0.8	
Solder eyelet Ø = D	mm	1.3	
Solder eyelet Ø tolerance	mm	+ 0,1	

Product data

IEC: 630 V / 17.5 A / 0.2 - 2.5 mm<sup>2</sup>  
 UL: 300 V / 15 A / AWG 24 - 14



For additional articles and information, refer to [catalog.weidmueller.com](http://catalog.weidmueller.com)

Note:

- Rated current related to rated cross-section & min. No. of poles.
- Wire end ferrule without plastic collar to DIN 46228/1
- Wire end ferrule with plastic collar to DIN 46228/4
- P on drawing = pitch
- Rated data refer only to the component itself. Clearance and creepage distances to other components are to be designed in accordance with the relevant application standards.
- It is necessary to hold the insulating body of the one or two pole terminal when tightening the screw

LM1N 5.08/..90

single row medium



Dimensioned drawing

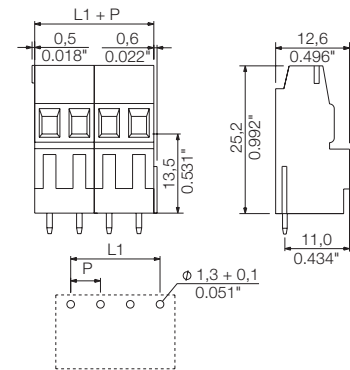

Ordering data

Solder pin length		3.5 mm	
Colour		Orange	
Pitch		5.08 mm	
Pol.	L1	(inch)	Qty. Order No.
2	5.08	0.200	100 1766300000
3	10.16	0.400	100 1766310000

Accessories

Note: Refer to the Accessories chapter for additional accessories.

Screwdriver		Order No.
	SDS 0.6X3.5X100	9008330000
	SDIS 0.6X3.5X100	9008390000

Representative deratings curve

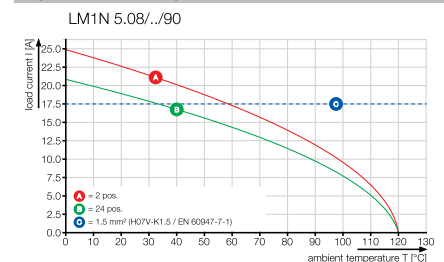



**LM1H 5.08/./90**

single row high



**Dimensioned drawing**

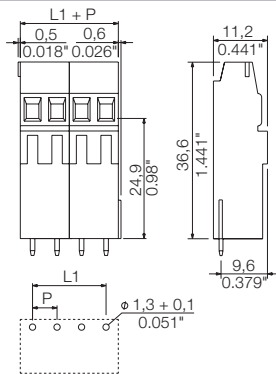

**Ordering data**

<b>Solder pin length</b>		3.5 mm	
<b>Colour</b>		Orange	
<b>Pitch</b>		5.08 mm	
Pol.	L1	(inch)	Qty. Order No.
2	5.08	0.200	100 <b>1766360000</b>
3	10.16	0.400	100 <b>1766370000</b>

**Additional deratings curves**

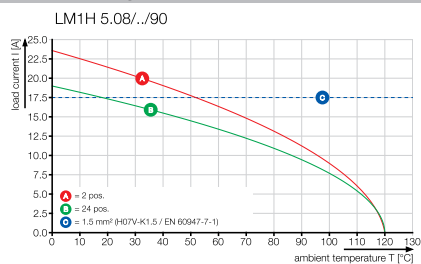

LM 5.08, multi-level

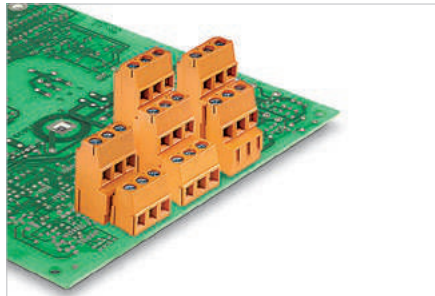

Multi-level PCB terminal with our proven clamping yoke screw connection in 5.08 mm pitch, suitable for wire cross-sections up to 2.5 mm<sup>2</sup>.

- Increased derating reserves through the use of WEMID insulating material
- Wire outlet direction: 90° version
- Block construction – can be aligned together for higher pole counts.

Technical data

In compliance with IEC 60664-1 / IEC 61984			
Clamping range, max.	mm <sup>2</sup>	0.2...2.5	
<b>Solid core H05(07) V-U</b>	<b>mm<sup>2</sup></b>	<b>0.2...2.5</b>	
Stranded H07 V-R			
Flexible H05(07) V-K	mm <sup>2</sup>	0.2...2.5	
Flexible with ferrule	mm <sup>2</sup>	0.25...1.5	
Ferrule with plastic collar	mm <sup>2</sup>	0.25...1.5	
Stripping length	mm	6	
Screwdriver blade	mm	0.6 x 3.5	
According to norm		DIN 5264	
Tightening torque range	Nm	0.4...0.5	
<b>Rated current, max.</b>	<b>A</b>	<b>17.5</b>	<b>17.5</b>
At ambient temperature	20°C	40°C	
For conductor cross-section			
Overtoltage category		III	III II
Pollution severity		3	2 2
<b>Rated voltage</b>	<b>V</b>	<b>250</b>	<b>320 630</b>
Rated impulse voltage	kV	4	4 4
<b>UL / CUL (Use Group)</b>		<b>B</b>	<b>C D</b>
<b>Rated voltage</b>	<b>V</b>	<b>300</b>	<b>300</b>
<b>Rated current</b>	<b>A</b>	<b>15</b>	<b>10</b>
<b>AWG conductor</b>	<b>AWG</b>	<b>24-14</b>	
<b>CSA (Use Group)</b>		<b>B</b>	<b>C D</b>
Rated voltage	V	300	300
Rated current	A	18	10
AWG conductor	AWG	24-14	
<b>General data</b>			
Type of insulation material		Wemid (PA)	
UL 94 flammability rating		V-0	
Contact base material		Copper alloy	
Material of contact surface		tinned	
Pin dimensions = d	mm	0.95 x 0.8	
Solder eyelet Ø = D	mm	1.3	
Solder eyelet Ø tolerance	mm	+ 0,1	

Product data

IEC: 630 V / 17.5 A / 0.2 - 2.5 mm<sup>2</sup>  
 UL: 300 V / 15 A / AWG 24 - 14



For additional articles and information, refer to [catalog.weidmueller.com](http://catalog.weidmueller.com)

Note:

- Rated current related to rated cross-section & min. No. of poles.
- Wire end ferrule without plastic collar to DIN 46228/1
- Wire end ferrule with plastic collar to DIN 46228/4
- P on drawing = pitch
- Rated data refer only to the component itself. Clearance and creepage distances to other components are to be designed in accordance with the relevant application standards.

LM2N 5.08/..../90

double row low



Dimensioned drawing

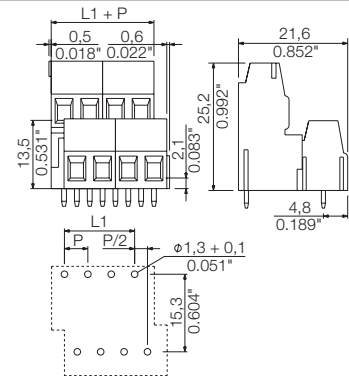

Ordering data

Solder pin length		3.5 mm		
Colour		Orange		
Pitch		5.08 mm		
Pol.	L1	(inch)	Qty.	Order No.
4	5.08	0.200	50	1768850000
6	10.16	0.400	50	1768860000
8	15.24	0.600	50	1768870000
10	20.32	0.800	50	1768880000
12	25.40	1.000	20	1768890000
14	30.48	1.200	20	1768900000
16	35.56	1.400	20	1768910000
18	40.64	1.600	20	1768920000
20	45.72	1.800	20	1768930000
22	50.80	2.000	20	1768940000
24	55.88	2.200	10	1768950000
26	60.96	2.400	10	1768960000
28	66.04	2.600	10	1768970000
30	71.12	2.800	10	1768980000
32	76.20	3.000	10	1768990000
34	81.28	3.200	10	1769000000
36	86.36	3.400	10	1769010000
38	91.44	3.600	10	1769020000
40	96.52	3.800	10	1769030000
42	101.60	4.000	10	1769040000
44	106.68	4.200	10	1769050000
46	111.76	4.400	10	1769060000
48	116.84	4.600	10	1769070000

Representative deratings curve

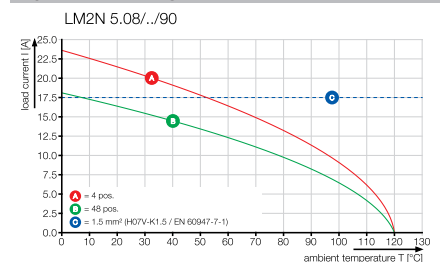

LM2H 5.08../90

double row high



Dimensioned drawing

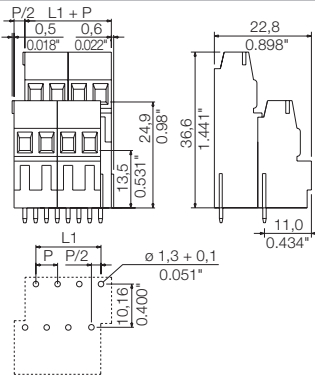

Ordering data

Solder pin length		3.5 mm	
Colour		Orange	
Pitch		5.08 mm	
Pol.	L1	(inch)	Qty. Order No.
4	5.08	0.200	50 1769240000
6	10.16	0.400	50 1769250000
8	15.24	0.600	50 1769260000
10	20.32	0.800	50 1769270000
12	25.40	1.000	20 1769280000
14	30.48	1.200	20 1769290000
16	35.56	1.400	20 1769300000
18	40.64	1.600	20 1769310000
20	45.72	1.800	20 1769320000
22	50.80	2.000	20 1769330000
24	55.88	2.200	10 1769340000
26	60.96	2.400	10 1769350000
28	66.04	2.600	10 1769360000
30	71.12	2.800	10 1769370000
32	76.20	3.000	10 1769380000
34	81.28	3.200	10 1769390000
36	86.36	3.400	10 1769400000
38	91.44	3.600	10 1769410000
40	96.52	3.800	10 1769420000
42	101.60	4.000	10 1769430000
44	106.68	4.200	10 1769440000
46	111.76	4.400	10 1769450000
48	111.76	4.400	10 1769460000

LM3R 5.08../90

triple row



Dimensioned drawing

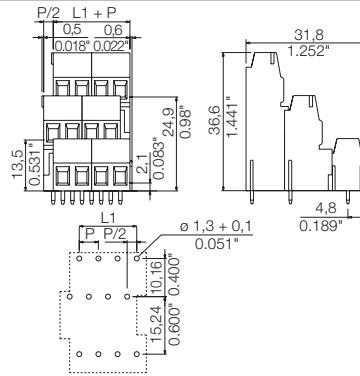

Ordering data

Solder pin length		3.5 mm	
Colour		Orange	
Pitch		5.08 mm	
Pol.	L1	(inch)	Qty. Order No.
6	5.08	0.200	50 1769620000
9	10.16	0.400	50 1769630000
12	15.24	0.600	50 1769640000
15	20.32	0.800	25 1769650000
18	25.40	1.000	25 1769660000
21	30.48	1.200	20 1769670000
24	35.56	1.400	20 1769680000
27	40.64	1.600	20 1769690000
30	45.72	1.800	10 1769700000
33	50.80	2.000	10 1769710000
36	55.88	2.200	10 1769720000
39	60.96	2.400	10 1769730000
42	66.04	2.600	10 1769740000
45	71.12	2.800	10 1769750000
48	76.20	3.000	10 1769760000
51	81.28	3.200	10 1769770000
54	86.36	3.400	5 1769780000
57	91.44	3.600	5 1769790000
60	96.52	3.800	5 1769800000
63	101.60	4.000	5 1769810000
66	106.68	4.200	5 1769820000
69	111.76	4.400	5 1769830000
72	116.84	4.600	5 1769840000

Additional deratings curves

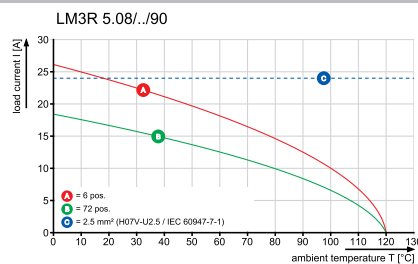
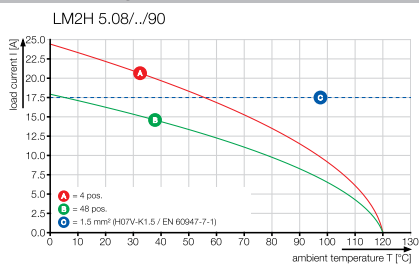

LL 5.00 & LL 5.08

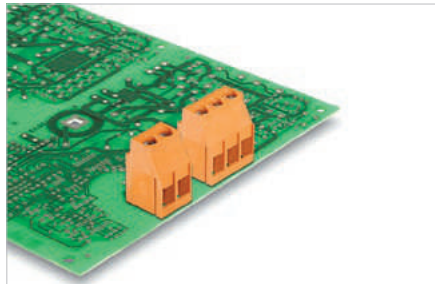

Single-row PCB terminal with our proven clamping yoke screw connection in 5.00 and 5.08 mm pitches, suitable for wire cross-sections up to 6.0 mm<sup>2</sup>.

- Increased derating reserves through the use of WEMID insulating material
- Wire outlet direction: 90° version
- 2- and 3-pole block construction – can be aligned together for higher pole counts.

Technical data

In compliance with IEC 60664-1 / IEC 61984			
Clamping range, max.	mm <sup>2</sup>	0.08...6	
<b>Solid core H05(07) V-U</b>	mm <sup>2</sup>	<b>0.5...6</b>	
Stranded H07 V-R			
Flexible H05(07) V-K	mm <sup>2</sup>	0.5...4	
Flexible with ferrule	mm <sup>2</sup>	0.5...2.5	
Ferrule with plastic collar	mm <sup>2</sup>	0.5...2.5	
Stripping length	mm	6	
Screwdriver blade	mm	0.6 x 3.5	
According to norm		DIN 5264	
Tightening torque range	Nm	0.5...0.6	
<b>Rated current, max.</b>	<b>A</b>	<b>32.5</b>	<b>27.5</b>
At ambient temperature		20°C	40°C
For conductor cross-section			
Overtoltage category		III	III II
Pollution severity		3	2 2
<b>Rated voltage</b>	<b>V</b>	<b>250</b>	<b>320 500</b>
Rated impulse voltage	kV	4	4 4
<b>UL / CUL (Use Group)</b>		<b>B</b>	<b>C D</b>
<b>Rated voltage</b>	<b>V</b>	<b>300</b>	<b>300</b>
<b>Rated current</b>	<b>A</b>	<b>20</b>	<b>10</b>
<b>AWG conductor</b>	<b>AWG</b>	<b>26-12</b>	
<b>CSA (Use Group)</b>		<b>B</b>	<b>C D</b>
Rated voltage	V	300	300
Rated current	A	20	10
AWG conductor	AWG	26-12	
General data			
Type of insulation material		Wemid (PA)	
UL 94 flammability rating		V-0	
Contact base material		Copper alloy	
Material of contact surface		tinned	
Pin dimensions = d	mm	0.75 x 0.9	
Solder eyelet Ø = D	mm	1.3	
Solder eyelet Ø tolerance	mm	+ 0,1	

Product data

IEC: 500 V / 32.5 A / 0.5 - 6 mm<sup>2</sup>  
 UL: 300 V / 20 A / AWG 26 - 12



For additional articles and information, refer to [catalog.weidmueller.com](http://catalog.weidmueller.com)

Note:

- Rated current related to rated cross-section & min. No. of poles.
- Wire end ferrule without plastic collar to DIN 46228/1
- Wire end ferrule with plastic collar to DIN 46228/4
- P on drawing = pitch
- Rated data refer only to the component itself. Clearance and creepage distances to other components are to be designed in accordance with the relevant application standards.
- It is necessary to hold the insulating body of the one or two pole terminal when tightening the screw

LL 5.00/./90



Dimensioned drawing

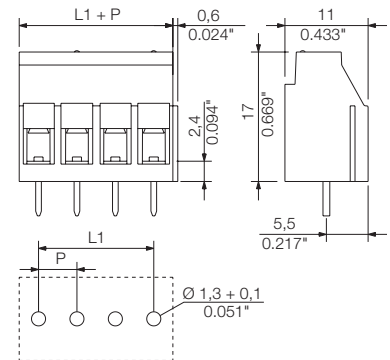

Ordering data

Solder pin length		3.2 mm	
Colour		Orange	
Pitch	5.00 mm	Qty.	Order No.
2	5.00	0.197	100 1934270000
3	10.00	0.394	100 1934280000
4	15.00	0.591	100 1001720000
5	20.00	0.788	50 1001730000
6	25.00	0.985	50 1001740000
7	30.00	1.182	50 1001750000
8	35.00	1.379	50 1001760000
9	40.00	1.576	50 1001770000
10	45.00	1.773	50 1001780000
11	50.00	1.970	50 1001790000
12	55.00	2.167	50 1001800000
13	60.00	2.364	50 1251330000
14	65.00	2.561	50 1001810000
15	70.00	2.758	50 1251340000
16	75.00	2.955	50 1001820000
17	80.00	3.152	20 1251350000
18	85.00	3.349	20 1251360000
19	90.00	3.546	20 1251370000
20	95.00	3.743	20 1251380000
21	100.00	3.940	20 1251390000
22	105.00	4.137	20 1251410000
23	110.00	4.334	20 1251420000
24	115.00	4.531	20 1001830000

Representative deratings curve

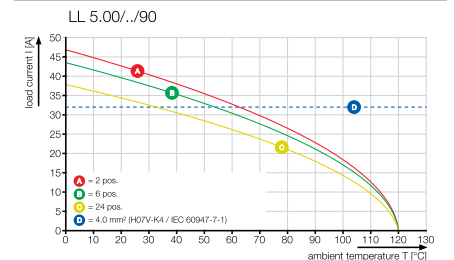

LL 5.08../90

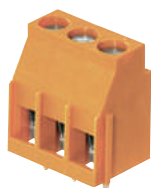

Dimensioned drawing

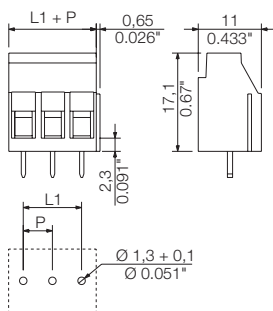

Ordering data

Solder pin length		3.2 mm	
Colour		Orange	
Pitch		5.08 mm	
Pol.	L1	(inch)	Qty. Order No.
2	5.08	0.200	100 1934250000
3	10.16	0.400	100 1934260000
4	15.24	0.600	100 1001850000
5	20.32	0.800	50 1001860000
6	25.40	1.000	50 1001870000
7	30.48	1.200	50 1001880000
8	35.56	1.400	50 1001890000
9	40.64	1.600	50 1001900000
10	45.72	1.800	50 1001910000
11	50.80	2.000	50 1001920000
12	55.88	2.200	50 1001930000
13	60.96	2.400	50 1001940000
14	66.04	2.600	50 1001950000
15	71.12	2.800	50 1001960000
16	76.20	3.000	50 1001970000
17	81.28	3.200	20 1001980000
18	86.36	3.400	20 1001990000
19	91.44	3.600	20 1002000000
20	96.52	3.800	20 1002010000
21	101.60	4.000	20 1002020000
22	106.68	4.200	20 1002030000
23	111.76	4.400	20 1002040000
24	116.84	4.600	20 1002050000

LL 5.00../180



Dimensioned drawing

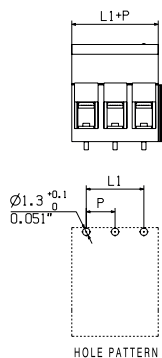

Ordering data

Solder pin length		3.2 mm	
Colour		Orange	
Pitch		5.00 mm	
Pol.	L1	(inch)	Qty. Order No.
2	5.00	0.197	174 1994230000
3	10.00	0.394	114 1994240000
4	15.00	0.591	90 2429470000
5	20.00	0.788	72 2429530000
6	25.00	0.985	60 2429540000
7	30.00	1.182	48 2429550000
8	35.00	1.379	42 2429560000
9	40.00	1.576	36 2429570000
10	45.00	1.773	36 2429580000
11	50.00	1.970	30 2429590000
12	55.00	2.167	30 2429600000
13	60.00	2.364	24 2429610000
14	65.00	2.561	24 2429620000
15	70.00	2.758	24 2429630000
16	75.00	2.955	18 2429640000
17	80.00	3.152	18 2429650000
18	85.00	3.349	18 2429660000
19	90.00	3.546	18 2429670000
20	95.00	3.743	18 2429680000
21	100.00	3.940	12 2429690000
22	105.00	4.137	12 2429700000
23	111.76	4.400	12 2429710000
24	116.84	4.600	12 2429720000

LL 5.08../180



Dimensioned drawing

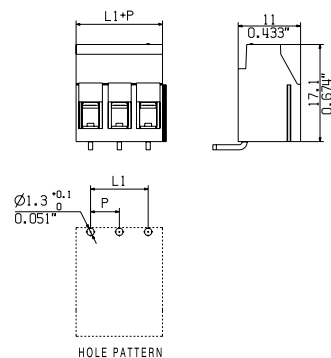

Ordering data

Solder pin length		3.2 mm	
Colour		Orange	
Pitch		5.08 mm	
Pol.	L1	(inch)	Qty. Order No.
2	5.08	0.200	168 1994250000
3	10.16	0.400	114 1994260000
4	15.24	0.600	84 2429810000
5	20.32	0.800	66 2431930000
6	25.40	1.000	60 2431950000
7	30.48	1.200	48 2431960000
8	35.56	1.400	42 2431970000
9	40.64	1.600	36 2431980000
10	45.72	1.800	36 2431990000
11	50.80	2.000	30 2432000000
12	55.88	2.200	30 2432010000
13	60.96	2.400	24 2432020000
14	66.04	2.600	24 2432030000
15	71.12	2.800	24 2432040000
16	76.20	3.000	18 2432050000
17	81.28	3.200	18 2432060000
18	86.36	3.400	18 2432070000
19	91.44	3.600	18 2432080000
20	96.52	3.800	18 2432090000
21	101.60	4.000	12 2432100000
22	106.68	4.200	12 2432110000
23	111.76	4.400	12 2432120000
24	116.84	4.600	12 2432130000

Additional deratings curves

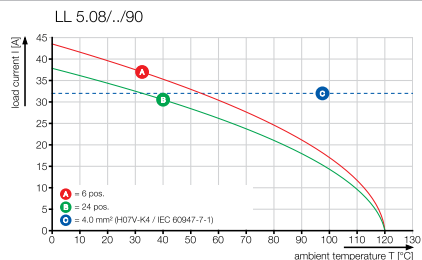

LL 5.00, multi-level

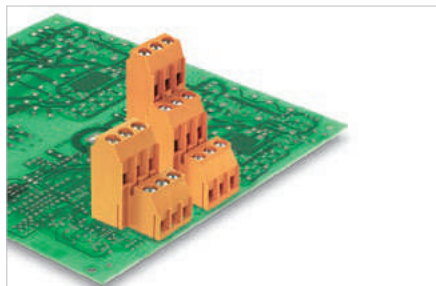

Multi-level PCB terminal with our proven clamping yoke screw connection in 5.00 mm pitch, suitable for wire cross-sections up to 6 mm<sup>2</sup>.

- Increased derating reserves through the use of WEMID insulating material
- Wire outlet direction: 90° version
- Block construction – can be aligned together for higher pole counts.

Technical data

In compliance with IEC 60664-1 / IEC 61984			
Clamping range, max.	mm <sup>2</sup>	0.08...6	
<b>Solid core H05(07) V-U</b>	<b>mm<sup>2</sup></b>	<b>0.5...6</b>	
Stranded H07 V-R			
Flexible H05(07) V-K	mm <sup>2</sup>	0.5...4	
Flexible with ferrule	mm <sup>2</sup>	0.5...2.5	
Ferrule with plastic collar	mm <sup>2</sup>	0.5...2.5	
Stripping length	mm	6	
Screwdriver blade	mm	0.6 x 3.5	
According to norm		DIN 5264	
Tightening torque range	Nm	0.5...0.6	
<b>Rated current, max.</b>	<b>A</b>	<b>32.5</b>	<b>27.5</b>
At ambient temperature	20°C	40°C	
For conductor cross-section			
Overtoltage category		III	III II
Pollution severity		3	2 2
<b>Rated voltage</b>	<b>V</b>	<b>250</b>	<b>320 500</b>
Rated impulse voltage	kV	4	4 4
<b>UL / CUL (Use Group)</b>		<b>B</b>	<b>C D</b>
<b>Rated voltage</b>	<b>V</b>	<b>300</b>	<b>300</b>
<b>Rated current</b>	<b>A</b>	<b>20</b>	<b>10</b>
<b>AWG conductor</b>	<b>AWG</b>	<b>26-12</b>	
<b>CSA (Use Group)</b>		<b>B</b>	<b>C D</b>
Rated voltage	V	300	300
Rated current	A	20	10
AWG conductor	AWG	26-12	
<b>General data</b>			
Type of insulation material		Wemid (PA)	
UL 94 flammability rating		V-0	
Contact base material		Copper alloy	
Material of contact surface		tinned	
Pin dimensions = d	mm	0.75 x 0.9	
Solder eyelet Ø = D	mm	1.3	
Solder eyelet Ø tolerance	mm	+ 0,1	

Product data

IEC: 500 V / 32.5 A / 0.5 - 6 mm<sup>2</sup>  
 UL: 300 V / 20 A / AWG 26 - 12



For additional articles and information, refer to [catalog.weidmueller.com](http://catalog.weidmueller.com)

Note:

- Rated current related to rated cross-section & min. No. of poles.
- Wire end ferrule without plastic collar to DIN 46228/1
- Wire end ferrule with plastic collar to DIN 46228/4
- P on drawing = pitch
- Rated data refer only to the component itself. Clearance and creepage distances to other components are to be designed in accordance with the relevant application standards.
- It is necessary to hold the insulating body of the one or two pole terminal when tightening the screw

LL1N 5.00/.. /90



Dimensioned drawing

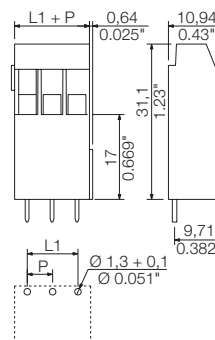

Accessories

Note: Refer to the Accessories chapter for additional accessories.

Screwdriver		Order No.
	SDS 0.6X3.5X100	9008330000
	SDIS 0.6X3.5X100	9008390000

Ordering data

Solder pin length		3.2 mm		
Colour		Orange		
Pitch	5.00 mm			
Pol.	L1	(inch)	Qty.	Order No.
2	5.00	0.197	100	1975250000
3	10.00	0.394	100	1975260000
4	15.00	0.591	100	1975270000
5	20.00	0.788	50	1975280000
6	25.00	0.985	50	1975290000
7	30.00	1.182	50	1975300000
8	35.00	1.379	50	1975310000
9	40.00	1.576	50	1975320000
10	45.00	1.773	50	1975330000
11	50.00	1.970	50	1975340000
12	55.00	2.167	50	1975350000

Representative deratings curve

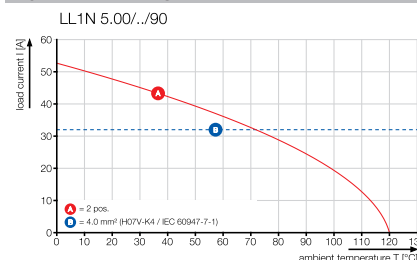

LL2N 5.00/./90



Dimensioned drawing

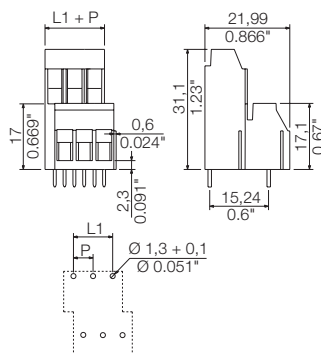

Ordering data

Solder pin length		3.2 mm			
Colour		Orange			
Pitch		5.00 mm			
Pol.	L1	(inch)	Qty.	Order No.	
4	10.00	0.197	50	1934310000	
8	15.00	0.591	50	1977260000	
12	25.00	0.985	50	1977280000	
16	35.00	1.379	20	1977310000	
20	45.00	1.773	20	1977330000	
24	55.00	2.167	10	1977350000	
28	65.00	2.561	10	1977370000	
32	75.00	2.955	10	1977390000	
36	85.00	3.349	10	1977410000	
40	95.00	3.743	10	1977430000	
44	105.00	4.137	10	1977450000	
48	115.00	4.531	10	1977470000	

LL3R 5.00/./90



Dimensioned drawing

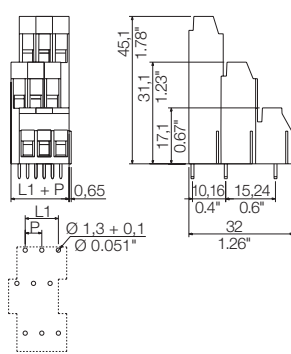

Ordering data

Solder pin length		3.2 mm			
Colour		Orange			
Pitch		5.00 mm			
Pol.	L1	(inch)	Qty.	Order No.	
6	5.00	0.197	50	1934360000	
12	15.00	0.591	50	1978850000	
18	25.00	0.985	25	1978870000	
24	35.00	1.379	20	1978890000	
30	45.00	1.773	10	1978910000	
36	55.00	2.167	10	1978930000	
42	65.00	2.561	10	1978950000	
48	75.00	2.955	10	1978970000	
54	85.00	3.349	10	1978990000	
60	95.00	3.743	5	1979010000	
66	105.00	4.137	5	1979030000	
72	115.00	4.531	5	1979050000	

Additional deratings curves

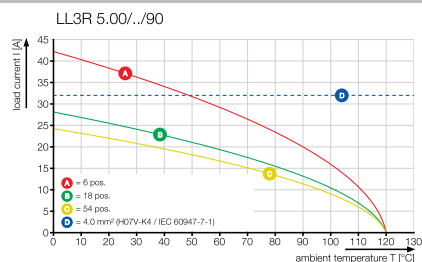
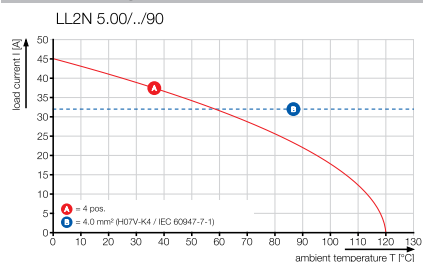

LL 5.08, multi-level

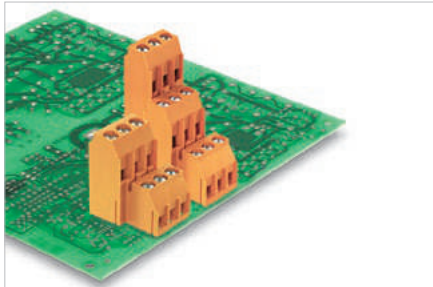

Multi-level PCB terminal with our proven clamping yoke screw connection in 5.08 mm pitch, suitable for wire cross-sections up to 6 mm<sup>2</sup>.

- Increased derating reserves through the use of WEMID insulating material
- Wire outlet direction: 90° version
- Block construction can be aligned together for higher pole counts.

Technical data

In compliance with IEC 60664-1 / IEC 61984			
Clamping range, max.	mm <sup>2</sup>	0.08...6	
<b>Solid core H05(07) V-U</b>	mm <sup>2</sup>	<b>0.5...6</b>	
Stranded H07 V-R			
Flexible H05(07) V-K	mm <sup>2</sup>	0.5...4	
Flexible with ferrule	mm <sup>2</sup>	0.5...2.5	
Ferrule with plastic collar	mm <sup>2</sup>	0.5...2.5	
Stripping length	mm	6	
Screwdriver blade	mm	0.6 x 3.5	
According to norm		DIN 5264	
Tightening torque range	Nm	0.5...0.6	
<b>Rated current, max.</b>	<b>A</b>	<b>32.5</b>	<b>27.5</b>
At ambient temperature	20°C	40°C	
For conductor cross-section			
Overtoltage category		III	III II
Pollution severity		3	2 2
<b>Rated voltage</b>	<b>V</b>	<b>250</b>	<b>320 500</b>
Rated impulse voltage	kV	4	4 4
<b>UL / CUL (Use Group)</b>		<b>B</b>	<b>C D</b>
<b>Rated voltage</b>	<b>V</b>	<b>300</b>	<b>300</b>
<b>Rated current</b>	<b>A</b>	<b>20</b>	<b>10</b>
<b>AWG conductor</b>	<b>AWG</b>	<b>26-12</b>	
<b>CSA (Use Group)</b>		<b>B</b>	<b>C D</b>
Rated voltage	V	300	300
Rated current	A	20	10
AWG conductor	AWG	26-12	
<b>General data</b>			
Type of insulation material		Wemid (PA)	
UL 94 flammability rating		V-0	
Contact base material		Copper alloy	
Material of contact surface		tinned	
Pin dimensions = d	mm	0.75 x 0.9	
Solder eyelet Ø = D	mm	1.3	
Solder eyelet Ø tolerance	mm	+ 0,1	

5.08

90°

6 mm<sup>2</sup>

Product data

IEC: 500 V / 32.5 A / 0.5 - 6 mm<sup>2</sup>  
 UL: 300 V / 20 A / AWG 26 - 12



For additional articles and information, refer to [catalog.weidmueller.com](http://catalog.weidmueller.com)

Note:

- Rated current related to rated cross-section & min. No. of poles.
- Wire end ferrule without plastic collar to DIN 46228/1
- Wire end ferrule with plastic collar to DIN 46228/4
- P on drawing = pitch
- Rated data refer only to the component itself. Clearance and creepage distances to other components are to be designed in accordance with the relevant application standards.
- It is necessary to hold the insulating body of the one or two pole terminal when tightening the screw

LL1N 5.08/./90



Dimensioned drawing

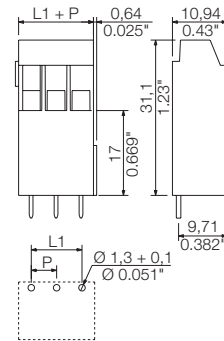

Accessories

Note: Refer to the Accessories chapter for additional accessories.

Screwdriver		Order No.
	SDS 0.6X3.5X100	9008330000
	SDIS 0.6X3.5X100	9008390000

Ordering data

Solder pin length		3.2 mm		
Colour		Orange		
Pitch		5.08 mm		
Pol.	L1	(inch)	Qty.	Order No.
2	5.08	0.200	100	1975360000
3	10.16	0.400	100	1975370000
4	15.24	0.600	100	1975380000
5	20.32	0.800	50	1975390000
6	25.40	1.000	50	1975400000
7	30.48	1.200	50	1975410000
8	35.56	1.400	50	1975420000
9	40.64	1.600	50	1975430000
10	45.72	1.800	50	1975440000
11	50.80	2.000	50	1975460000
12	55.88	2.200	50	1975470000

Representative deratings curve

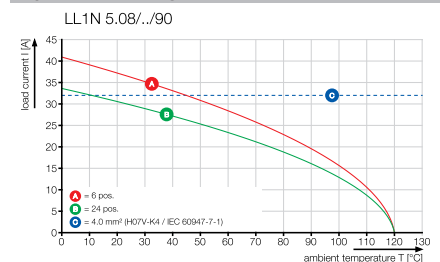



LL2N 5.08/./90



Dimensioned drawing

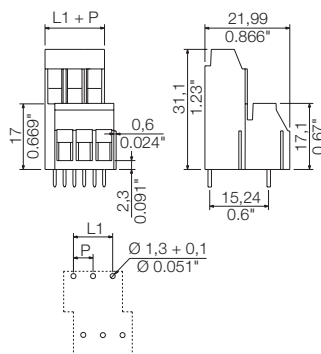

Ordering data

Solder pin length		3.2 mm			
Colour		Orange			
Pitch		5.08 mm			
Pol.	L1	(inch)	Qty.	Order No.	
8	15.24	0.600	50	1977480000	
12	25.40	1.000	50	1977500000	
16	35.56	1.400	20	1977520000	
20	45.72	1.800	20	1977540000	
24	55.88	2.200	10	1977560000	
28	66.04	2.600	10	1977580000	
32	76.20	3.000	10	1977600000	
36	86.36	3.400	10	1977620000	
40	96.52	3.800	10	1977640000	
44	106.68	4.200	10	1977660000	
48	116.84	4.600	10	1977680000	

LL3R 5.08/./90



Dimensioned drawing

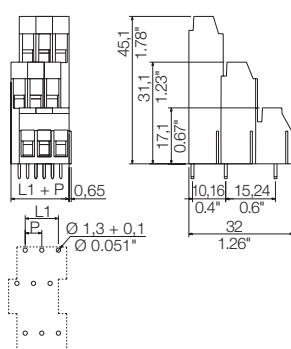

Ordering data

Solder pin length		3.2 mm			
Colour		Orange			
Pitch		5.08 mm			
Pol.	L1	(inch)	Qty.	Order No.	
6	5.08	0.200	50	1934340000	
12	15.24	0.600	50	1979060000	
18	25.40	1.000	25	1979080000	
24	35.56	1.400	20	1979100000	
30	45.72	1.800	10	1979120000	
36	55.88	2.200	10	1979140000	
42	66.04	2.600	10	1979160000	
48	76.20	3.000	10	1979180000	
54	86.36	3.400	10	1979200000	
60	96.52	3.800	5	1979220000	
66	106.68	4.200	5	1979240000	
72	116.84	4.600	5	1979260000	

Additional deratings curves

LL2N 5.08/./90

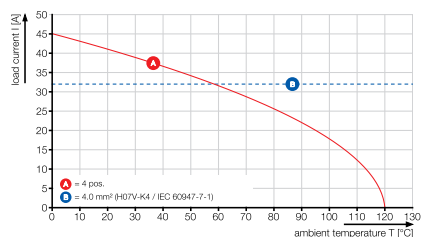

LL3R 5.08/./90

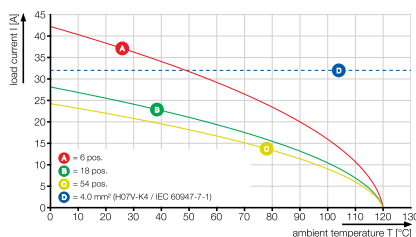

LL 9.52

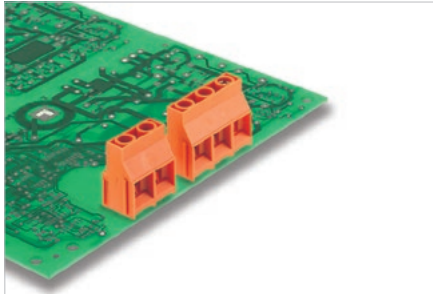

Single-row PCB terminal with our proven clamping-yoke screw connection in 9.52 mm pitch, suitable for wire cross-sections up to 6 mm<sup>2</sup>.

- Increased derating reserves through the use of WEMID insulating material
- Wire outlet direction: 90° version
- 2- and 3-pole block construction – can be aligned together for higher pole counts.

Technical data

In compliance with IEC 60664-1 / IEC 61984			
Clamping range, max.	mm <sup>2</sup>	0.18...6	
<b>Solid core H05(07) V-U</b>	<b>mm<sup>2</sup></b>	<b>0.18...6</b>	
Stranded H07 V-R			
Flexible H05(07) V-K	mm <sup>2</sup>	0.22...4	
Flexible with ferrule	mm <sup>2</sup>	0.5...4	
Ferrule with plastic collar	mm <sup>2</sup>	0.5...2.5	
Stripping length	mm	7	
Screwdriver blade	mm	0.8 x 4.0	
According to norm		DIN 5264	
Tightening torque range	Nm	0.5...0.6	
<b>Rated current, max.</b>	<b>A</b>	<b>32</b>	<b>32</b>
At ambient temperature		20°C	40°C
For conductor cross-section			
Overtoltage category		III	III II
Pollution severity		3	2 2
<b>Rated voltage</b>	<b>V</b>	<b>690</b>	<b>1000 1000</b>
Rated impulse voltage	kV	8	8 6
<b>UL / CUL (Use Group)</b>	<b>B C D</b>	<b>B</b>	<b>C D</b>
<b>Rated voltage</b>	<b>V</b>	<b>300</b>	<b>300</b>
<b>Rated current</b>	<b>A</b>	<b>30</b>	<b>30</b>
<b>AWG conductor</b>	<b>AWG</b>	<b>26-10</b>	
<b>CSA (Use Group)</b>	<b>B C D</b>	<b>B</b>	<b>C D</b>
Rated voltage	V	300	300
Rated current	A	30	35
AWG conductor	AWG	26-10	
<b>General data</b>			
Type of insulation material		Wemid (PA)	
UL 94 flammability rating		V-0	
Contact base material		Copper alloy	
Material of contact surface		tinned	
Pin dimensions = d	mm	0.5 x 1.0	
Solder eyelet Ø = D	mm	1.3	
Solder eyelet Ø tolerance	mm	+ 0,1	

9.52

90°

6 mm<sup>2</sup>

Product data

IEC: 1000 V / 32 A / 0.18 - 6 mm<sup>2</sup>  
 UL: 300 V / 30 A / AWG 26 - 10



For additional articles and information, refer to [catalog.weidmueller.com](http://catalog.weidmueller.com)

Note:

- Rated current related to rated cross-section & min. No. of poles.
- Wire end ferrule without plastic collar to DIN 46228/1
- Wire end ferrule with plastic collar to DIN 46228/4
- P on drawing = pitch
- Rated data refer only to the component itself. Clearance and creepage distances to other components are to be designed in accordance with the relevant application standards.
- It is necessary to hold the insulating body of the one or two pole terminal when tightening the screw

LL 9.52../90



Dimensioned drawing

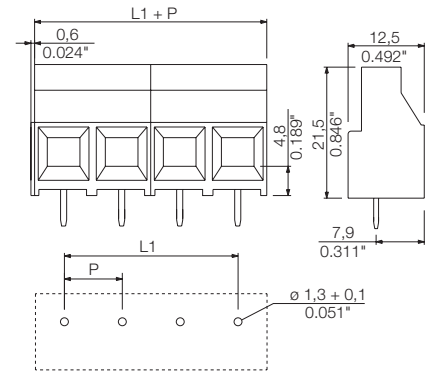

Accessories

Note: Refer to the Accessories chapter for additional accessories.

Screwdriver		Order No.
	SDS 0.8X4.0X100	9008340000
	SDIS 0.8X4.0X100	9008400000
	SDK PZ1	9008530000

Ordering data

Solder pin length		5 mm		
Colour		Orange		
Pitch		9.52 mm		
Pol.	L1	(inch)	Qty.	Order No.
2	9.52	0.375	100	1724680000
3	19.04	0.750	100	1724690000

Representative deratings curve

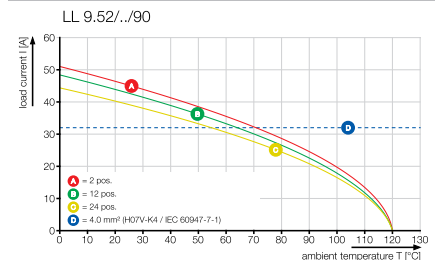

## LL 9.52, multi-level



Double-level PCB terminal with our proven clamping yoke screw connection in 9.52 mm pitch, suitable for wire cross-sections up to 6 mm<sup>2</sup>.

- Increased derating reserves through the use of WEMID insulating material
- Wire outlet direction: 90° version
- Block construction – can be aligned together for higher pole counts.

## Product data

IEC: 1000 V / 32 A / 0.18 - 6 mm<sup>2</sup>  
UL: 300 V / 30 A / AWG 26 - 10



For additional articles and information, refer to [catalog.weidmueller.com](http://catalog.weidmueller.com)

## Note:

- Rated current related to rated cross-section & min. No. of poles.
- Wire end ferrule without plastic collar to DIN 46228/1
- Wire end ferrule with plastic collar to DIN 46228/4
- P on drawing = pitch
- Rated data refer only to the component itself. Clearance and creepage distances to other components are to be designed in accordance with the relevant application standards.

## LL2N 9.52/./90



## Dimensioned drawing

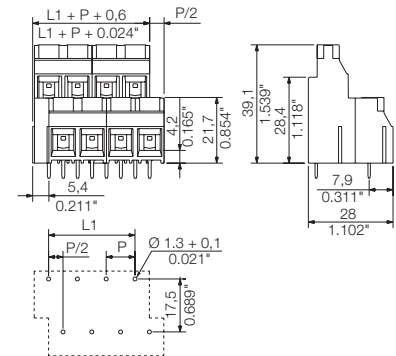



## Technical data

## In compliance with IEC 60664-1 / IEC 61984

Clamping range, max.	mm <sup>2</sup>	0.18...6
<b>Solid core H05(07) V-U</b>	<b>mm<sup>2</sup></b>	<b>0.18...6</b>
Stranded H07 V-R		
Flexible H05(07) V-K	mm <sup>2</sup>	0.22...4
Flexible with ferrule	mm <sup>2</sup>	0.5...2.5
Ferrule with plastic collar	mm <sup>2</sup>	0.5...2.5
Stripping length	mm	7
Screwdriver blade	mm	0.8 x 4.0
According to norm		DIN 5264
Tightening torque range	Nm	0.5...0.6
<b>Rated current, max.</b>	<b>A</b>	<b>32 32</b>
At ambient temperature	20°C	40°C
For conductor cross-section		
Overtoltage category		III III II
Pollution severity		3 2 2
<b>Rated voltage</b>	<b>V</b>	<b>690 690 1000</b>
Rated impulse voltage	kV	6 6 6
<b>UL / CUL (Use Group)</b>	<b>B C D</b>	
<b>Rated voltage</b>	<b>V</b>	<b>300 300</b>
<b>Rated current</b>	<b>A</b>	<b>30 30</b>
<b>AWG conductor</b>	<b>AWG</b>	<b>26-10</b>
<b>CSA (Use Group)</b>	<b>B C D</b>	
Rated voltage	V	300 300
Rated current	A	30 30
AWG conductor	AWG	26-10
<b>General data</b>		
Type of insulation material		Wemid (PA)
UL 94 flammability rating		V-0
Contact base material		Copper alloy
Material of contact surface		tinned
Pin dimensions = d	mm	0.5 x 1.0
Solder eyelet Ø = D	mm	1.3
Solder eyelet Ø tolerance	mm	+ 0,1

## Accessories

Note: Refer to the Accessories chapter for additional accessories.

Screwdriver		Order No.
	SDS 0.8X4.0X100	<b>9008340000</b>
	SDIS 0.8X4.0X100	<b>9008400000</b>
	SDK PZ1	<b>9008530000</b>

## Ordering data

Solder pin length		5 mm		
Colour		Orange		
Pitch		9.52 mm		
Pol.	L1	(inch)	Qty.	Order No.
4	9.52	3.750	10	<b>1926350000</b>
8	28.56	11.250	10	<b>1926360000</b>
12	47.60	18.750	10	<b>1926370000</b>
16	66.64	26.250	5	<b>1926380000</b>
20	85.68	33.750	5	<b>1926390000</b>
24	104.72	41.250	5	<b>1926400000</b>

## Representative deratings curve

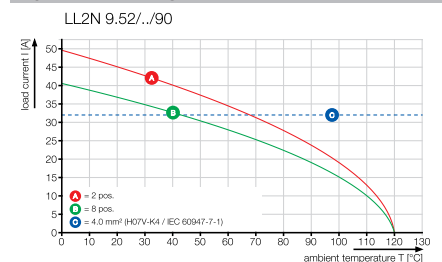

TOP 1.5GS../-5.08

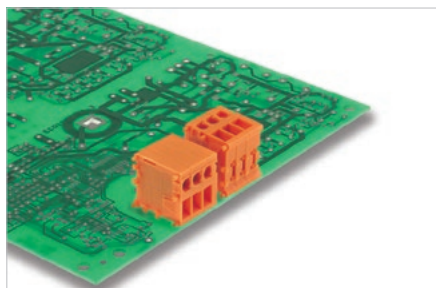

PCB terminal with TOP screw connection in 5.08 mm pitch for wire cross-sections up to 2.5 mm<sup>2</sup>.

- Conductor entry and screw connection in the same direction.
- In versions with 90° (horizontal) or 180° (vertical) angle to PCB.

Technical data

<b>In compliance with IEC 60664-1 / IEC 61984</b>			
Clamping range, max.	mm <sup>2</sup>	0.13...2.5	
<b>Solid core H05(07) V-U</b>	mm <sup>2</sup>	<b>0.5...2.5</b>	
Stranded H07 V-R			
Flexible H05(07) V-K	mm <sup>2</sup>	0.5...2.5	
Flexible with ferrule	mm <sup>2</sup>	0.5...2.5	
Ferrule with plastic collar	mm <sup>2</sup>	0.5...2.5	
Stripping length	mm	10	
Screwdriver blade	mm	0.6 x 3.5	
According to norm		DIN 5264	
Tightening torque range	Nm	0.4...0.5	
<b>Rated current, max.</b>	<b>A</b>	<b>24</b>	<b>21</b>
At ambient temperature		20°C	40°C
For conductor cross-section			
Overtoltage category		III	III II
Pollution severity		3	2 2
<b>Rated voltage</b>	<b>V</b>	<b>250</b>	<b>320 630</b>
Rated impulse voltage	kV	2.5	2.5 2.5
<b>UL / CUL (Use Group)</b>		<b>B</b>	<b>C D</b>
<b>Rated voltage</b>	<b>V</b>	<b>300</b>	<b>300</b>
<b>Rated current</b>	<b>A</b>	<b>10</b>	<b>10</b>
<b>AWG conductor</b>	<b>AWG</b>	<b>26-14</b>	
<b>CSA (Use Group)</b>		<b>B</b>	<b>C D</b>
Rated voltage	V	300	300
Rated current	A	10	10
AWG conductor	AWG	26-14	
<b>General data</b>			
Type of insulation material		PA	
UL 94 flammability rating		V-2	
Contact base material		CuZn	
Material of contact surface		tinned	
Pin dimensions = d	mm	0.8 x 1.0	
Solder eyelet Ø = D	mm	1.3	
Solder eyelet Ø tolerance	mm	+ 0,1	

Product data

IEC: 630 V / 24 A / 0.5 - 2.5 mm<sup>2</sup>  
 UL: 300 V / 10 A / AWG 26 - 14



For additional articles and information, refer to [catalog.weidmueller.com](http://catalog.weidmueller.com)

Note:

- Additional colours on request
- Rated current related to rated cross-section & min. No. of poles.
- Wire end ferrule without plastic collar to DIN 46228/1
- Wire end ferrule with plastic collar to DIN 46228/4
- Crimp form A for wire end ferrules with PZ 6/5 crimping tool are recommended for the largest cable sizes.
- P on drawing = pitch
- Rated data refer only to the component itself. Clearance and creepage distances to other components are to be designed in accordance with the relevant application standards.

TOP 1.5GS../-90-5.08



Dimensioned drawing

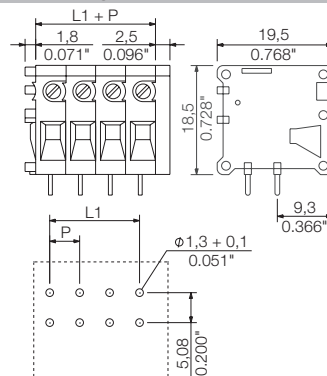

Ordering data

<b>Solder pin length</b>		3.5 mm		
<b>Colour</b>		Orange		
<b>Pitch</b>		5.08 mm		
Pol.	L1	(inch)	Qty.	Order No.
2	5.08	0.200	100	0641960000
3	10.16	0.400	100	0642060000
4	15.24	0.600	50	0642160000
5	20.32	0.800	50	1578820000
6	25.40	1.000	50	0593860000
7	30.48	1.200	50	0593960000
8	35.56	1.400	50	0594060000
9	40.64	1.600	50	0594160000
10	45.72	1.800	50	0642260000
11	50.80	2.000	50	0594260000
12	55.88	2.200	50	0594360000
13	60.96	2.400	50	0594460000
14	66.04	2.600	50	0594560000
15	71.12	2.800	50	0594660000
16	76.20	3.000	20	0642360000
17	81.28	3.200	20	0594760000
18	86.36	3.400	20	1707040000
19	91.44	3.600	10	0594960000
20	96.52	3.800	10	0595060000
21	101.60	4.000	10	0595160000
22	106.68	4.200	10	0595260000
23	111.76	4.400	10	0595360000
24	116.84	4.600	10	0595460000

Representative deratings curve

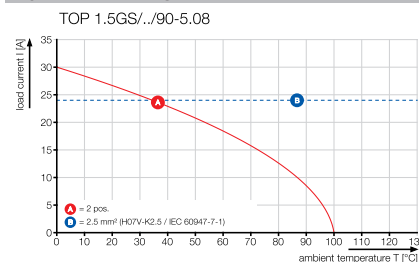

TOP 1.5GS../180-5.08



Dimensioned drawing

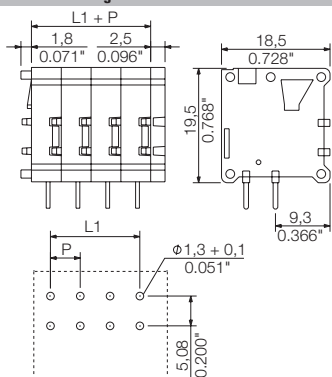

Ordering data

Solder pin length		4.5 mm		
Colour		Orange		
Pitch		5.08 mm		
Pol.	L1	(inch)	Qty.	Order No.
2	5.08	0.200	100	0569960000
3	10.16	0.400	100	0570160000
4	15.24	0.600	50	0570360000
5	20.32	0.800	50	0597360000
6	25.40	1.000	50	0597460000
7	30.48	1.200	50	1695700000
8	35.56	1.400	25	0597660000
9	40.64	1.600	20	1474660000
10	45.72	1.800	20	0570560000
11	50.80	2.000	20	1474760000
12	55.88	2.200	20	0597960000
13	60.96	2.400	20	1724740000
14	66.04	2.600	20	0598160000
15	71.12	2.800	20	1782490000
16	76.20	3.000	20	0570760000
17	81.28	3.200	20	0598360000
18	86.36	3.400	20	0598460000
19	91.44	3.600	20	0598560000
20	96.52	3.800	20	0598660000
21	101.60	4.000	10	0598760000
22	106.68	4.200	10	0598860000
23	111.76	4.400	10	0598960000
24	116.84	4.600	10	0599060000

Additional deratings curves

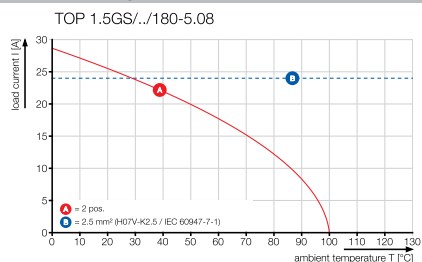

TOP 1.5GS../-7.62

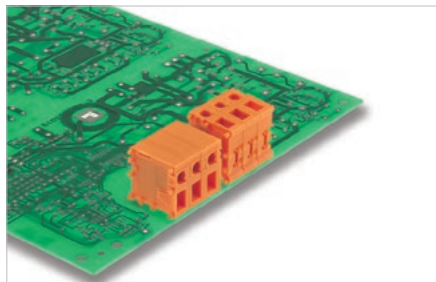

PCB terminal with TOP screw connection in 7.62 mm pitch for wire cross-sections up to 2.5 mm<sup>2</sup>.

- Conductor entry and screw connection in the same direction.
- In versions with 90° (horizontal) or 180° (vertical) angle to PCB.

Technical data

<b>In compliance with IEC 60664-1 / IEC 61984</b>			
Clamping range, max.	mm <sup>2</sup>	0.13...2.5	
<b>Solid core H05(07) V-U</b>	<b>mm<sup>2</sup></b>	<b>0.5...2.5</b>	
Stranded H07 V-R			
Flexible H05(07) V-K	mm <sup>2</sup>	0.5...2.5	
Flexible with ferrule	mm <sup>2</sup>	0.5...2.5	
Ferrule with plastic collar	mm <sup>2</sup>	0.5...2.5	
Stripping length	mm	10	
Screwdriver blade	mm	0.6 x 3.5	
According to norm		DIN 5264	
Tightening torque range	Nm	0.4...0.5	
<b>Rated current, max.</b>	<b>A</b>	<b>24</b>	<b>21</b>
At ambient temperature		20°C	40°C
For conductor cross-section			
Overtoltage category		III	III II
Pollution severity		3	2 2
<b>Rated voltage</b>	<b>V</b>	<b>400</b>	<b>630 1000</b>
Rated impulse voltage	kV	4	4 4
<b>UL / CUL (Use Group)</b>	<b>B C D</b>	<b>B</b>	<b>C D</b>
<b>Rated voltage</b>	<b>V</b>	<b>300</b>	<b>300</b>
<b>Rated current</b>	<b>A</b>	<b>10</b>	<b>10</b>
<b>AWG conductor</b>	<b>AWG</b>	<b>26-14</b>	
<b>CSA (Use Group)</b>	<b>B C D</b>	<b>B</b>	<b>C D</b>
Rated voltage	V	300	300
Rated current	A	10	10
AWG conductor	AWG	26-14	
<b>General data</b>			
Type of insulation material		PA	
UL 94 flammability rating		V-2	
Contact base material		CuZn	
Material of contact surface		tinned	
Pin dimensions = d	mm	0.8 x 1.0	
Solder eyelet Ø = D	mm	1.3	
Solder eyelet Ø tolerance	mm	+ 0,1	

7.62  
90°  
2.5 mm<sup>2</sup>

Product data

IEC: 1000 V / 24 A / 0.5 - 2.5 mm<sup>2</sup>  
UL: 300 V / 10 A / AWG 26 - 14



For additional articles and information, refer to [catalog.weidmueller.com](http://catalog.weidmueller.com)

Note:

- Additional colours on request
- Rated current related to rated cross-section & min. No. of poles.
- Wire end ferrule without plastic collar to DIN 46228/1
- Wire end ferrule with plastic collar to DIN 46228/4
- Crimp form A for wire end ferrules with PZ 6/5 crimping tool are recommended for the largest cable sizes.
- P on drawing = pitch
- Rated data refer only to the component itself. Clearance and creepage distances to other components are to be designed in accordance with the relevant application standards.

TOP 1.5GS../-90-7.62



Dimensioned drawing

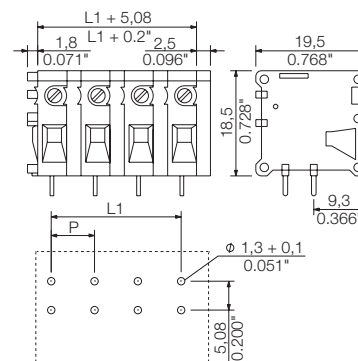

Accessories

Note: Refer to the Accessories chapter for additional accessories.

<b>Mounting block</b>		<b>Order No.</b>
	TOP1.5GS BB OR	1539860000
<b>Screwdriver</b>		
	SDS 0.6X3.5X100	9008330000
	SDIS 0.6X3.5X100	9008390000

Ordering data

<b>Solder pin length</b>	3.5 mm			
<b>Colour</b>	Orange			
<b>Pitch</b>	7.62 mm			
<b>Pol.</b>	<b>L1</b>	<b>(inch)</b>	<b>Qty.</b>	<b>Order No.</b>
2	7.62	0.300	100	0393360000
3	15.24	0.600	100	0393460000
4	22.86	0.900	50	0393560000
5	30.48	1.200	25	0393660000
6	38.10	1.500	20	1683990000
7	45.72	1.800	20	1647310000
8	53.34	2.100	20	0642460000
9	60.96	2.400	20	0393960000
10	68.58	2.700	20	0642560000
11	76.20	3.000	20	0394060000
12	83.82	3.300	20	0394160000

Representative deratings curve

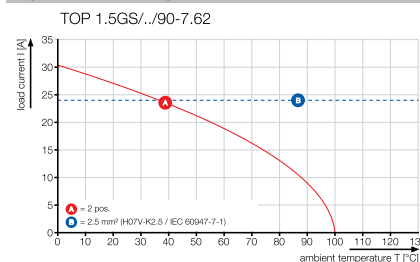

TOP 1.5GS../180-7.62



Dimensioned drawing

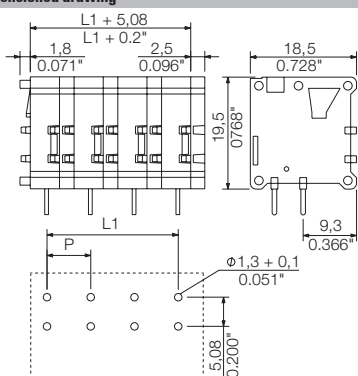

Ordering data

Solder pin length		4.5 mm	
Colour		Orange	
Pitch		7.62 mm	
Pol.	L1	(inch)	Qty. Order No.
2	7.62	0.300	100 <b>0391360000</b>
3	15.24	0.600	50 <b>0391460000</b>
4	22.86	0.900	50 <b>0391560000</b>
5	30.48	1.200	25 <b>1490460000</b>
6	38.10	1.500	25 <b>1597060000</b>
7	45.72	1.800	25 <b>1597070000</b>
8	53.34	2.100	20 <b>0570960000</b>
9	60.96	2.400	20 <b>1597080000</b>
10	68.58	2.700	20 <b>0571160000</b>
11	76.20	3.000	20 <b>1597090000</b>
12	83.82	3.300	20 <b>0392160000</b>

Additional deratings curves

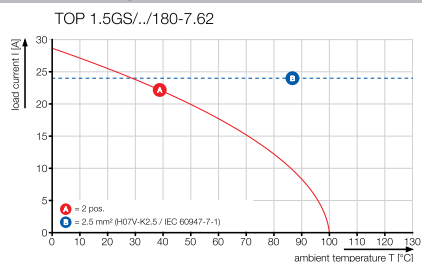

TOP 4GS../-6.35

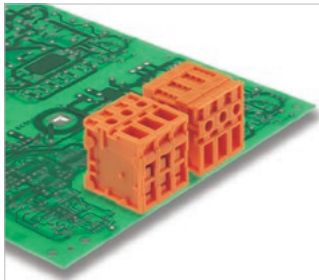

PCB terminal with TOP screw connection in 6.35 mm pitch for wire cross-sections up to 6.0 mm<sup>2</sup>.

- Conductor entry and screw connection in the same direction.
- In versions with 90° (horizontal) or 180° (vertical) angle to PCB.

Technical data

In compliance with IEC 60664-1 / IEC 61984			
Clamping range, max.	mm <sup>2</sup>	0.13...6	
<b>Solid core H05(07) V-U</b>	<b>mm<sup>2</sup></b>	<b>0.5...6</b>	
Stranded H07 V-R			
Flexible H05(07) V-K	mm <sup>2</sup>	0.5...4	
Flexible with ferrule	mm <sup>2</sup>	0.5...4	
Ferrule with plastic collar	mm <sup>2</sup>	0.5...4	
Stripping length	mm	13	
Screwdriver blade	mm	0.6 x 3.5	
According to norm		DIN 5264	
Tightening torque range	Nm	0.5...0.6	
<b>Rated current, max.</b>		<b>32</b>	<b>32</b>
At ambient temperature	20°C	40°C	
For conductor cross-section			
Overtoltage category		III	III II
Pollution severity		3	2 2
<b>Rated voltage</b>	<b>V</b>	<b>320</b>	<b>320 320</b>
Rated impulse voltage	kV	2.5	2.5 2.5
<b>UL / CUL (Use Group)</b>		<b>B</b>	<b>C D</b>
<b>Rated voltage</b>	<b>V</b>	<b>300</b>	<b>300</b>
<b>Rated current</b>	<b>A</b>	<b>30</b>	<b>10</b>
<b>AWG conductor</b>	<b>AWG</b>	<b>26-10</b>	
<b>CSA (Use Group)</b>		<b>B</b>	<b>C D</b>
Rated voltage	V	300	300
Rated current	A	30	10
AWG conductor	AWG	26-10	
<b>General data</b>			
Type of insulation material		PA	
UL 94 flammability rating		V-2	
Contact base material		E-Cu	
Material of contact surface		tinned	
Pin dimensions = d	mm	0.8 x 0.8	
Solder eyelet Ø = D	mm	1.3	
Solder eyelet Ø tolerance	mm	+ 0,1	

6.35

90°

6 mm<sup>2</sup>

Product data

IEC: 320 V / 32 A / 0.5 - 6 mm<sup>2</sup>  
 UL: 300 V / 30 A / AWG 26 - 10



For additional articles and information, refer to [catalog.weidmueller.com](http://catalog.weidmueller.com)

Note:

- Additional colours on request
- Rated current related to rated cross-section & min. No. of poles.
- Wire end ferrule without plastic collar to DIN 46228/1
- Wire end ferrule with plastic collar to DIN 46228/4
- Crimp form A for wire end ferrules with PZ 6/5 crimping tool are recommended for the largest cable sizes.
- P on drawing = pitch
- Rated data refer only to the component itself. Clearance and creepage distances to other components are to be designed in accordance with the relevant application standards.

TOP 4GS../90-6.35



Dimensioned drawing

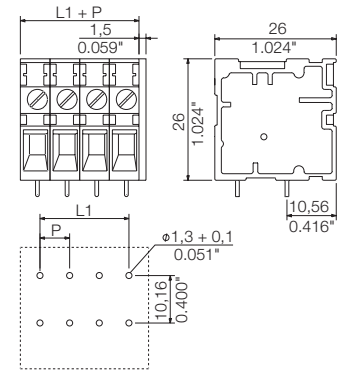

Accessories

Note: Refer to the Accessories chapter for additional accessories.

Screwdriver		Order No.
	SDS 0.6X3.5X100	9008330000
	SDIS 0.6X3.5X100	9008390000

Ordering data

Solder pin length		3.5 mm		
Colour		Orange		
Pitch		6.35 mm		
Pol.	L1	(inch)	Qty.	Order No.
2	6.35	0.250	100	1401760000
3	12.70	0.500	100	1650300000
4	19.05	0.750	50	1786030000
5	25.40	1.000	50	1786040000
6	31.75	1.250	50	1786050000
7	38.10	1.500	50	1786060000
8	44.45	1.750	50	1667910000
9	50.80	2.000	50	1786070000
10	57.15	2.250	50	1786080000
11	63.50	2.500	50	1786090000
12	69.85	2.750	50	1786100000

Representative deratings curve

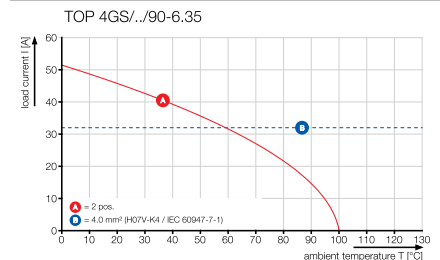



TOP 4GS/./180-6.35



Dimensioned drawing

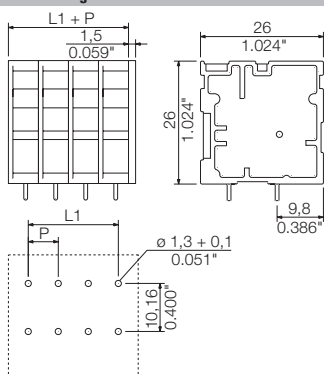

Ordering data

Solder pin length		3.5 mm	
Colour		Orange	
Pitch		6.35 mm	
Pol.	L1	(inch)	Qty. Order No.
2	6.35	0.250	100 1786190000
3	12.70	0.500	100 1786200000
4	19.05	0.750	50 1786210000
5	25.40	1.000	50 1786220000
6	31.75	1.250	50 1786230000
7	38.10	1.500	50 1786240000
8	44.45	1.750	50 1786250000
9	50.80	2.000	50 1786260000
10	57.15	2.250	50 1786270000
11	63.50	2.500	50 1786280000
12	69.85	2.750	50 1786290000

Additional deratings curves

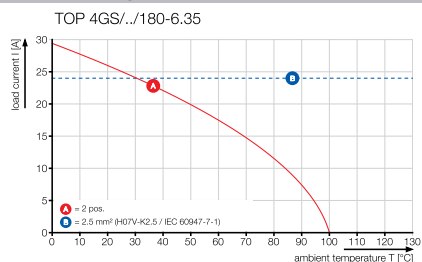

TOP 4GS../-7.62

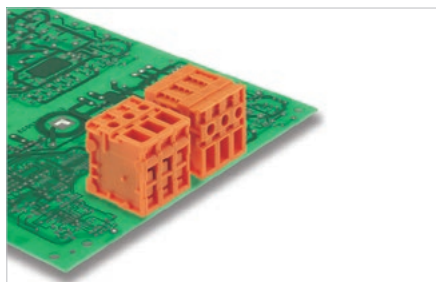

PCB terminal with TOP screw connection in 7.62 mm pitch for wire cross-sections up to 6.0 mm<sup>2</sup>.

- Conductor entry and screw connection in the same direction.
- In versions with 90° (horizontal) or 180° (vertical) angle to PCB.

Technical data

<b>In compliance with IEC 60664-1 / IEC 61984</b>			
Clamping range, max.	mm <sup>2</sup>	0.13...6	
<b>Solid core H05(07) V-U</b>	mm <sup>2</sup>	<b>0.5...6</b>	
Stranded H07 V-R			
Flexible H05(07) V-K	mm <sup>2</sup>	0.5...4	
Flexible with ferrule	mm <sup>2</sup>	0.5...4	
Ferrule with plastic collar	mm <sup>2</sup>	0.5...4	
Stripping length	mm	13	
Screwdriver blade	mm	0.6 x 3.5	
According to norm		DIN 5264	
Tightening torque range	Nm	0.5...0.6	
<b>Rated current, max.</b>		<b>32</b>	<b>32</b>
At ambient temperature	20°C		40°C
For conductor cross-section			
Overtoltage category		III	III II
Pollution severity		3	2 2
<b>Rated voltage</b>	V	<b>500</b>	<b>630 1000</b>
Rated impulse voltage	kV	4	4 4
<b>UL / CUL (Use Group)</b>		<b>B</b>	<b>C D</b>
<b>Rated voltage</b>	V	<b>300</b>	<b>300</b>
<b>Rated current</b>	A	<b>30</b>	<b>10</b>
<b>AWG conductor</b>	AWG	<b>26-10</b>	
<b>CSA (Use Group)</b>		<b>B</b>	<b>C D</b>
Rated voltage	V	300	300
Rated current	A	30	10
AWG conductor	AWG	26-10	
<b>General data</b>			
Type of insulation material		PA	
UL 94 flammability rating		V-2	
Contact base material		E-Cu	
Material of contact surface		tinned	
Pin dimensions = d	mm	0.8 x 0.8	
Solder eyelet Ø = D	mm	1.3	
Solder eyelet Ø tolerance	mm	+ 0,1	

Product data

IEC: 1000 V / 32 A / 0.5 - 6 mm<sup>2</sup>  
 UL: 300 V / 30 A / AWG 26 - 10



For additional articles and information, refer to [catalog.weidmueller.com](http://catalog.weidmueller.com)

Note:

- Additional colours on request
- Rated current related to rated cross-section & min. No. of poles.
- Wire end ferrule without plastic collar to DIN 46228/1
- Wire end ferrule with plastic collar to DIN 46228/4
- Crimp form A for wire end ferrules with PZ 6/5 crimping tool are recommended for the largest cable sizes.
- P on drawing = pitch
- Rated data refer only to the component itself. Clearance and creepage distances to other components are to be designed in accordance with the relevant application standards.

TOP 4GS../-90-7.62



Dimensioned drawing

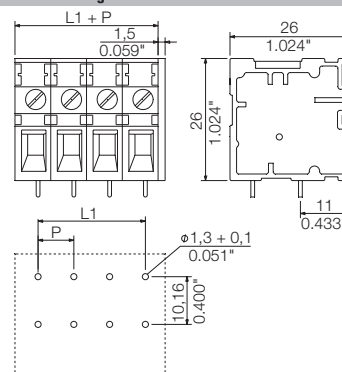

Ordering data

<b>Solder pin length</b>		3.5 mm		
<b>Colour</b>		Orange		
<b>Pitch</b>		7.62 mm		
Pol.	L1	(inch)	Qty.	Order No.
2	7.62	0.300	50	0289660000
3	15.24	0.600	50	0289760000
4	22.86	0.900	50	0290160000
5	30.48	1.200	50	1698740000
6	38.10	1.500	50	1786410000
7	45.72	1.800	50	1647300000
8	53.34	2.100	50	1786420000
9	60.96	2.400	50	1786430000
10	68.58	2.700	50	1786440000
11	76.20	3.000	50	1759860000
12	83.82	3.300	50	1786450000

Accessories

Note: Refer to the Accessories chapter for additional accessories.

Screwdriver		Order No.
	SDS 0.6X3.5X100	9008330000
	SDIS 0.6X3.5X100	9008390000

Representative deratings curve

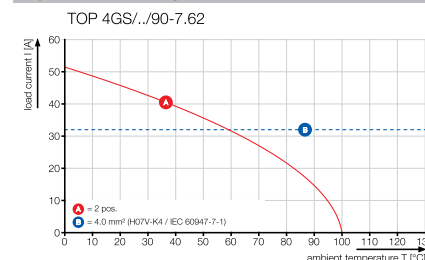

TOP 4GS/./180-7.62



Dimensioned drawing

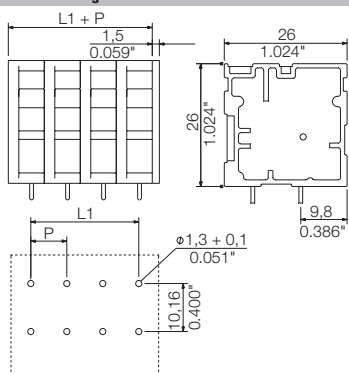

Ordering data

Solder pin length		3.5 mm	
Colour		Orange	
Pitch		7.62 mm	
Pol.	L1	(inch)	Qty. Order No.
2	7.62	0.300	50 0298360000
3	15.24	0.600	50 0298460000
4	22.86	0.900	50 0298560000
5	30.48	1.200	50 1786540000
6	38.10	1.500	50 1494560000
7	45.72	1.800	50 1786550000
8	53.34	2.100	50 1786560000
9	60.96	2.400	50 1571700000
10	68.58	2.700	50 1786570000
11	76.20	3.000	50 1786580000
12	83.82	3.300	50 1749170000

Additional deratings curves

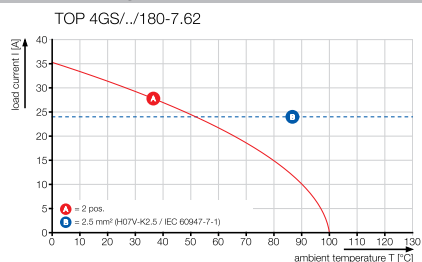

PS 3.5/..90

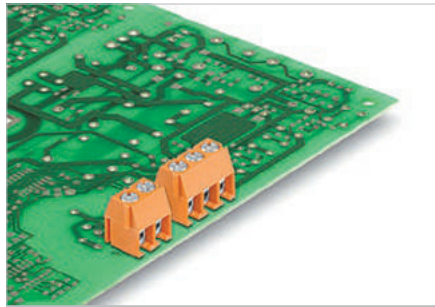

Highly compact PCB terminal with leaf spring screw connection in 3.5 mm pitch for wire cross-sections up to 1.5 mm<sup>2</sup>.

- Increased derating reserves through the use of WEMID insulating material
- Wire outlet direction: 90° version
- 2- and 3-pole block construction – can be aligned together for higher pole counts.

Technical data

<b>In compliance with IEC 60664-1 / IEC 61984</b>			
Clamping range, max.	mm <sup>2</sup>	0.08...1.5	
<b>Solid core H05(07) V-U</b>	mm <sup>2</sup>	<b>0.2...1.5</b>	
Stranded H07 V-R			
Flexible H05(07) V-K	mm <sup>2</sup>	0.2...1.5	
Flexible with ferrule	mm <sup>2</sup>	0.25...0.75	
Ferrule with plastic collar	mm <sup>2</sup>	0.25...0.75	
Stripping length	mm	4	
Screwdriver blade	mm	0.4 x 2.5	
According to norm		DIN 5264	
Tightening torque range	Nm	0.2...0.25	
<b>Rated current, max.</b>	<b>A</b>	<b>17.5</b>	<b>17.5</b>
At ambient temperature	20°C	40°C	
For conductor cross-section			
Overtoltage category		III	III II
Pollution severity		3	2 2
<b>Rated voltage</b>	<b>V</b>	<b>160</b>	<b>160 320</b>
Rated impulse voltage	kV	2.5	2.5 2.5
<b>UL / CUL (Use Group)</b>		<b>B</b>	<b>C D</b>
<b>Rated voltage</b>	<b>V</b>	<b>300</b>	<b>300</b>
<b>Rated current</b>	<b>A</b>	<b>10</b>	<b>10</b>
<b>AWG conductor</b>	<b>AWG</b>	<b>28-16</b>	
<b>CSA (Use Group)</b>		<b>B</b>	<b>C D</b>
Rated voltage	V	300	
Rated current	A	10	
AWG conductor	AWG	28-16	
<b>General data</b>			
Type of insulation material		Wemid (PA)	
UL 94 flammability rating		V-0	
Contact base material		Copper alloy	
Material of contact surface		tinned	
Pin dimensions = d	mm	0.8	
Solder eyelet Ø = D	mm	1.3	
Solder eyelet Ø tolerance	mm	+ 0,1	

Product data

IEC: 320 V / 17.5 A / 0.2 - 1.5 mm<sup>2</sup>  
 UL: 300 V / 10 A / AWG 28 - 16



For additional articles and information, refer to [catalog.weidmueller.com](http://catalog.weidmueller.com)

Note:

- Rated current related to rated cross-section & min. No. of poles.
- Wire end ferrule without plastic collar to DIN 46228/1
- Wire end ferrule with plastic collar to DIN 46228/4
- The data given under CSA relates to a cUL approval - E60693
- P on drawing = pitch
- Rated data refer only to the component itself. Clearance and creepage distances to other components are to be designed in accordance with the relevant application standards.
- It is necessary to hold the insulating body of the one or two pole terminal when tightening the screw

PS 3.5/..90



Dimensioned drawing

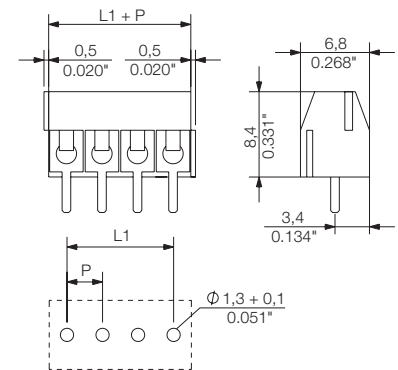

Ordering data

<b>Solder pin length</b>		3.5 mm		
<b>Colour</b>		Orange		
<b>Pitch</b>		3.50 mm		
Pol.	L1	(inch)	Qty.	Order No.
2	3.50	0.138	100	1912320000
3	7.00	0.276	100	1912330000
4	10.50	0.413	100	1912340000
5	14.00	0.551	100	1912350000
6	17.50	0.689	100	1912360000
7	21.00	0.827	100	1912370000
8	24.50	0.965	100	1912380000
9	28.00	1.102	100	1912390000
10	31.50	1.240	100	1912400000
11	35.00	1.378	100	1912410000
12	38.50	1.516	100	1912420000

Accessories

Note: Refer to the Accessories chapter for additional accessories.

Screwdriver		Order No.
	SDIS 0.6X3.5X100	9008390000

Representative deratings curve

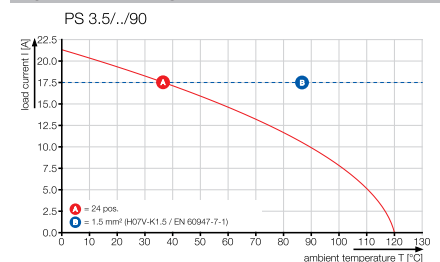



PM 5.00/./90

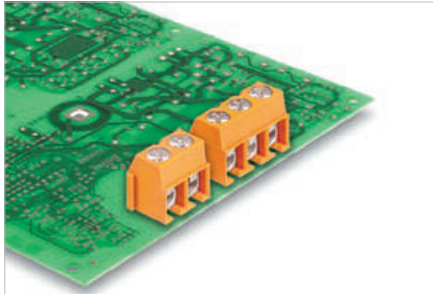

PCB terminal with leaf spring screw connection in 5.00 and 5.08 mm pitches for wire cross-sections up to 2.5 mm<sup>2</sup>.

- Increased derating reserves through the use of WEMID insulating material
- Wire outlet direction: 90° version
- 2- and 3-pole block construction – can be aligned together for higher pole counts.

Technical data

In compliance with IEC 60664-1 / IEC 61984			
Clamping range, max.	mm <sup>2</sup>	0.13...2.5	
<b>Solid core H05(07) V-U</b>	<b>mm<sup>2</sup></b>	<b>0.13...2.5</b>	
Stranded H07 V-R			
Flexible H05(07) V-K	mm <sup>2</sup>	0.13...2.5	
Flexible with ferrule	mm <sup>2</sup>	0.25...1.5	
Ferrule with plastic collar	mm <sup>2</sup>	0.25...1.5	
Stripping length	mm	6	
Screwdriver blade	mm	0.6 x 3.5	
According to norm		DIN 5264	
Tightening torque range	Nm	0.4...0.5	
<b>Rated current, max.</b>	<b>A</b>	<b>24</b>	<b>24</b>
At ambient temperature		20°C	40°C
For conductor cross-section			
Overtoltage category		III	III II
Pollution severity		3	2 2
<b>Rated voltage</b>	<b>V</b>	<b>250</b>	<b>250 600</b>
Rated impulse voltage	kV	4	4 4
<b>UL / CUL (Use Group)</b>		<b>B</b>	<b>C D</b>
<b>Rated voltage</b>	<b>V</b>	<b>300</b>	<b>300</b>
<b>Rated current</b>	<b>A</b>	<b>15</b>	<b>10</b>
<b>AWG conductor</b>	<b>AWG</b>	<b>26-14</b>	
<b>CSA (Use Group)</b>		<b>B</b>	<b>C D</b>
Rated voltage	V	300	300
Rated current	A	15	10
AWG conductor	AWG	26-14	
<b>General data</b>			
Type of insulation material		Wemid (PA)	
UL 94 flammability rating		V-0	
Contact base material		Copper alloy	
Material of contact surface		tinned	
Pin dimensions = d	mm	1.0	
Solder eyelet Ø = D	mm	1.3	
Solder eyelet Ø tolerance	mm	+ 0,1	

Product data

IEC: 600 V / 24 A / 0.13 - 2.5 mm<sup>2</sup>  
 UL: 300 V / 15 A / AWG 26 - 14



For additional articles and information, refer to [catalog.weidmueller.com](http://catalog.weidmueller.com)

Note:

- Rated current related to rated cross-section & min. No. of poles.
- Wire end ferrule without plastic collar to DIN 46228/1
- Wire end ferrule with plastic collar to DIN 46228/4
- The data given under CSA relates to a cUL approval - E60693
- P on drawing = pitch
- Rated data refer only to the component itself. Clearance and creepage distances to other components are to be designed in accordance with the relevant application standards.

PM 5.00/./90



Dimensioned drawing

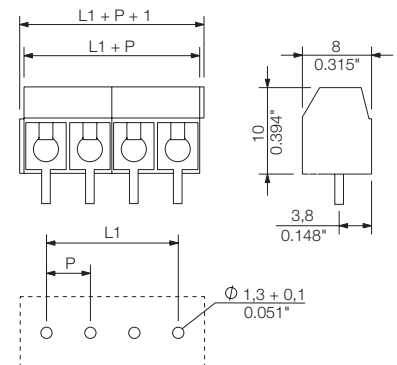

Ordering data

Solder pin length		3.5 mm		
Colour		Orange		
Pitch	5.00 mm			
Pol.	L1	(inch)	Qty.	Order No.
2	5.00	0.197	500	1791610000
3	10.00	0.394	500	1791620000
4	15.00	0.591	100	1234650000
5	20.00	0.787	100	1234670000
6	25.00	0.984	100	1234680000
7	30.00	1.181	100	1234690000
8	35.00	1.378	100	1234700000
9	40.00	1.575	100	1234710000
10	45.00	1.772	100	1234720000
11	50.00	1.969	100	1234730000
12	55.00	2.165	100	1234740000

Accessories

Note: Refer to the Accessories chapter for additional accessories.

Screwdriver		Order No.
	SDIS 0.6X3.5X100	9008390000

Representative deratings curve

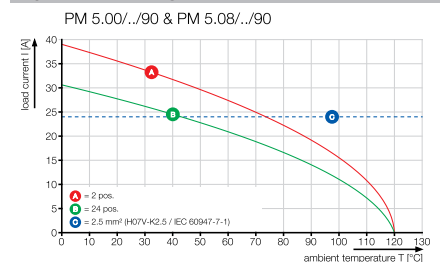

PM 5.08/./90

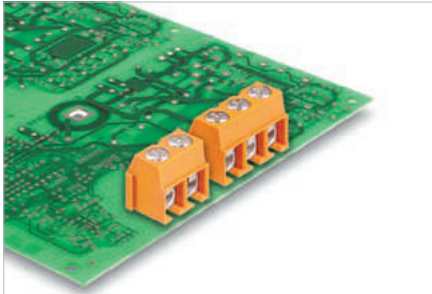

PCB terminal with leaf spring screw connection in 5.00 and 5.08 mm pitches for wire cross-sections up to 2.5 mm<sup>2</sup>.

- Increased derating reserves through the use of WEMID insulating material
- Wire outlet direction: 90° version
- 2- and 3-pole block construction – can be aligned together for higher pole counts.

Technical data

In compliance with IEC 60664-1 / IEC 61984			
Clamping range, max.	mm <sup>2</sup>	0.13...2.5	
<b>Solid core H05(07) V-U</b>	<b>mm<sup>2</sup></b>	<b>0.13...2.5</b>	
Stranded H07 V-R			
Flexible H05(07) V-K	mm <sup>2</sup>	0.13...2.5	
Flexible with ferrule	mm <sup>2</sup>	0.25...1.5	
Ferrule with plastic collar	mm <sup>2</sup>	0.25...1.5	
Stripping length	mm	6	
Screwdriver blade	mm	0.6 x 3.5	
According to norm		DIN 5264	
Tightening torque range	Nm	0.4...0.5	
<b>Rated current, max.</b>	<b>A</b>	<b>24</b>	<b>24</b>
At ambient temperature		20°C	40°C
For conductor cross-section			
Overtoltage category		III	III II
Pollution severity		3	2 2
<b>Rated voltage</b>	<b>V</b>	<b>250</b>	<b>250 600</b>
Rated impulse voltage	kV	4	4 4
<b>UL / CUL (Use Group)</b>		<b>B</b>	<b>C D</b>
<b>Rated voltage</b>	<b>V</b>	<b>300</b>	<b>300</b>
<b>Rated current</b>	<b>A</b>	<b>15</b>	<b>10</b>
<b>AWG conductor</b>	<b>AWG</b>	<b>26-14</b>	
<b>CSA (Use Group)</b>		<b>B</b>	<b>C D</b>
Rated voltage	V	300	300
Rated current	A	15	10
AWG conductor	AWG	26-14	
General data			
Type of insulation material		Wemid (PA)	
UL 94 flammability rating		V-0	
Contact base material		Copper alloy	
Material of contact surface		tinned	
Pin dimensions = d	mm	1.0	
Solder eyelet Ø = D	mm	1.3	
Solder eyelet Ø tolerance	mm	+ 0,1	

Product data

IEC: 600 V / 24 A / 0.13 - 2.5 mm<sup>2</sup>  
 UL: 300 V / 15 A / AWG 26 - 14



For additional articles and information, refer to [catalog.weidmueller.com](http://catalog.weidmueller.com)

Note:

- Rated current related to rated cross-section & min. No. of poles.
- Wire end ferrule without plastic collar to DIN 46228/1
- Wire end ferrule with plastic collar to DIN 46228/4
- The data given under CSA relates to a cUL approval - E60693
- P on drawing = pitch
- Rated data refer only to the component itself. Clearance and creepage distances to other components are to be designed in accordance with the relevant application standards.

PM 5.08/./90



Dimensioned drawing

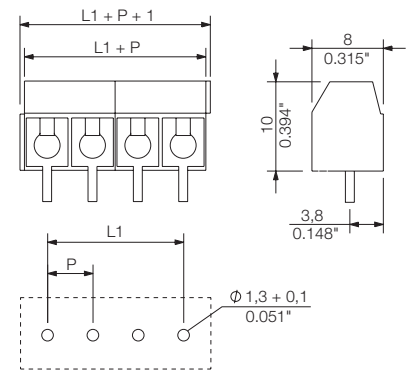

Accessories

Note: Refer to the Accessories chapter for additional accessories.

Screwdriver		Order No.
	SDIS 0.6X3.5X100	9008390000

Ordering data

Solder pin length		3.5 mm		
Colour		Orange		
Pitch		5.08 mm		
Pol.	L1	(inch)	Qty.	Order No.
2	5.08	0.200	500	1760490000
3	10.16	0.400	500	1760500000
4	15.24	0.600	100	1234550000
5	20.32	0.800	100	1234570000
6	25.40	1.000	100	1234580000
7	30.48	1.200	100	1234590000
8	35.56	1.400	100	1234600000
9	40.64	1.600	100	1234610000
10	45.72	1.800	50	1234620000
11	50.80	2.000	100	1234630000
12	55.88	2.200	100	1234640000

Representative deratings curve

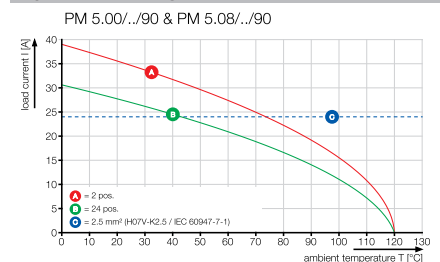

LSF-SMT 3.5/./90

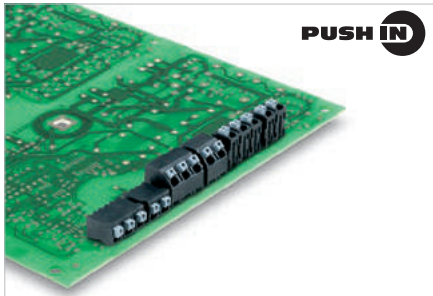

PCB terminal for fully automatic assembly, in 3.5 mm pitch, for THR reflow soldering (SMT) and wave soldering.

- PUSH IN spring connection system for wire cross-sections up to 1.5 mm<sup>2</sup>.
- Form and dimensional stability through the use of LCP insulating material.
- Wire connection and slider operation from the same direction (TOP).
- Packaged in tube or tape-on-reel.
- Pin lengths optimised to 1.5 mm or 3.5 mm.
- Wire outlet direction: 90° version

Technical data

<b>In compliance with IEC 60664-1 / IEC 61984</b>			
Clamping range, max.	mm <sup>2</sup>	0.13...1.5	
<b>Solid core H05(07) V-U</b>	<b>mm<sup>2</sup></b>	<b>0.2...1.5</b>	
Stranded H07 V-R			
Flexible H05(07) V-K	mm <sup>2</sup>	0.2...1.5	
Flexible with ferrule	mm <sup>2</sup>	0.25...1.5	
Ferrule with plastic collar	mm <sup>2</sup>	0.25...0.75	
Stripping length	mm	8	
Screwdriver blade	mm		
According to norm			
Tightening torque range			
<b>Rated current, max.</b>	<b>A</b>	<b>17.5</b>	<b>17.5</b>
At ambient temperature		20°C	40°C
For conductor cross-section			
Overtolerance category		III	III II
Pollution severity		3	2 2
<b>Rated voltage</b>	<b>V</b>	<b>160</b>	<b>160 320</b>
Rated impulse voltage	kV	2.5	2.5 2.5
<b>UL / CUL (Use Group)</b>		<b>B</b>	<b>C D</b>
<b>Rated voltage</b>	<b>V</b>	<b>300</b>	<b>300</b>
<b>Rated current</b>	<b>A</b>	<b>12</b>	<b>10</b>
<b>AWG conductor</b>	<b>AWG</b>	<b>28-14</b>	
<b>CSA (Use Group)</b>		<b>B</b>	<b>C D</b>
Rated voltage	V	300	300
Rated current	A	10	10
AWG conductor	AWG	28-14	
<b>General data</b>			
Type of insulation material		LCP GF	
UL 94 flammability rating		V-0	
Contact base material		Copper alloy	
Material of contact surface			
Pin dimensions = d	mm	0.35 x 0.8	
Solder eyelet Ø = D	mm	1.1	
Solder eyelet Ø tolerance	mm	+ 0,1	

Product data

IEC: 320 V / 17.5 A / 0.2 - 1.5 mm<sup>2</sup>  
 UL: 300 V / 12 A / AWG 28 - 14



For additional articles and information, refer to [catalog.weidmuller.com](http://catalog.weidmuller.com)

Note:

- Additional push button colours on request
- Operating force of slider max. 40 N
- Rated current related to rated cross-section & min. No. of poles.
- Wire end ferrule with plastic collar to DIN 46228/4
- Wire end ferrule without plastic collar to DIN 46228/1
- P on drawing = pitch
- Rated data refer only to the component itself. Clearance and creepage distances to other components are to be designed in accordance with the relevant application standards.
- Crimping shape "A" for wire end ferrules with PZ 6/5 crimping tool are recommended for the largest cable sizes.

LSF-SMT 3.5/./90

Reflow-compatible PCB terminal



Dimensioned drawing

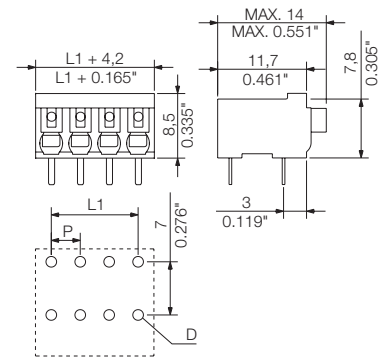

Accessories

Note: Refer to the Accessories chapter for additional accessories.

Screwdriver		Order No.
	SDS 0.4X2.5X75	9009030000
	SDIS 0.4X2.5X75	9008370000

Ordering data

Solder pin length	1.5 mm		3.5 mm	
	Black	Black	Black	Black
<b>Pitch</b>	<b>3.50 mm</b>			
Pol.	L1 (inch)	Qty.	Order No.	Order No.
2	3.50	0.138	71	1870500000 1824420000
3	7.00	0.276	49	1870530000 1824430000
4	10.50	0.413	37	1870550000 1824440000
5	14.00	0.551	30	1870580000 1824450000
6	17.50	0.689	25	1870590000 1824460000
7	21.00	0.827	21	1871020000 1824470000
8	24.50	0.965	19	1871030000 1824480000
9	28.00	1.102	17	1871040000 1824490000
10	31.50	1.240	15	1871050000 1824500000
11	35.00	1.378	14	1871060000 1824510000
12	38.50	1.516	12	1871070000 1824520000
13	42.00	1.654	11	1871080000 1870380000
14	45.50	1.791	11	1871090000 1870390000
15	49.00	1.929	10	1871100000 1870400000
16	52.50	2.067	9	1871110000 1870410000
17	56.00	2.205	9	1871120000 1870420000
18	59.50	2.343	8	1871130000 1870430000
19	63.00	2.480	8	1871140000 1870440000
20	66.50	2.618	7	1871150000 1870450000
21	70.00	2.756	7	1871160000 1870460000
22	73.50	2.894	7	1871170000 1870470000
23	77.00	3.031	6	1871180000 1870480000
24	80.50	3.169	6	1871190000 1870490000

Representative deratings curve

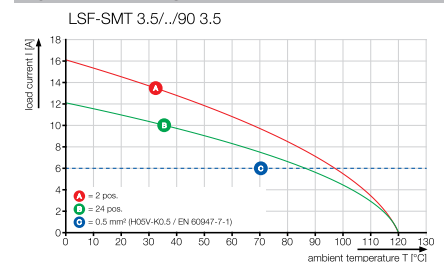



LSF-SMT 3.5/./90 Tape

Reflow-compatible PCB terminal



Dimensioned drawing

Ordering data

Solder pin length		1.5 mm	3.5 mm		
Colour		Black	Black		
Pitch		3.50 mm			
Pol.	L1 (inch)	Qty.	Order No.		
2	3.50	0.138	265	1874690000	1874990000
3	7.00	0.276	265	1874710000	1875030000
4	10.50	0.413	265	1874730000	1875050000
5	14.00	0.551	265	1874740000	1875070000
6	17.50	0.689	265	1874810000	1875080000
7	21.00	0.827	265	1874840000	1875100000
8	24.50	0.965	265	1874890000	1875110000
9	28.00	1.102	265	1874900000	1875120000
10	31.50	1.240	265	1874930000	1875130000
11	35.00	1.378	265	1874940000	1875140000
12	38.50	1.516	265	1874970000	1875160000

Belt widths: 32, 44, 56, 72, 88

Additional deratings curves

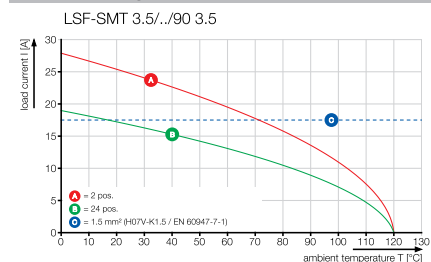

LSF-SMT 3.5/./135

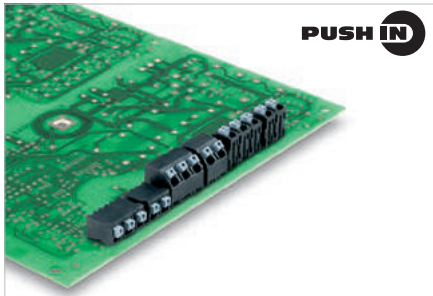

PCB terminal for fully automatic assembly, in 3.5 mm pitch, for THR reflow soldering (SMT) and wave soldering.

- PUSH IN spring connection system for wire cross-sections up to 1.5 mm<sup>2</sup>.
- Form and dimensional stability through the use of LCP insulating material.
- Wire connection and slider operation from the same direction (TOP).
- Packaged in tube or tape-on-reel.
- Pin lengths optimised to 1.5 mm or 3.5 mm.
- Wire outlet direction: 135° version

Technical data

<b>In compliance with IEC 60664-1 / IEC 61984</b>			
Clamping range, max.	mm <sup>2</sup>	0.13...1.5	
<b>Solid core H05(07) V-U</b>	<b>mm<sup>2</sup></b>	<b>0.2...1.5</b>	
Stranded H07 V-R			
Flexible H05(07) V-K	mm <sup>2</sup>	0.2...1.5	
Flexible with ferrule	mm <sup>2</sup>	0.25...1.5	
Ferrule with plastic collar	mm <sup>2</sup>	0.25...0.75	
Stripping length	mm	8	
Screwdriver blade	mm		
According to norm			
Tightening torque range			
<b>Rated current, max.</b>	<b>A</b>	<b>17.5</b>	<b>17.5</b>
At ambient temperature		20°C	40°C
For conductor cross-section			
Overtoltage category		III	III II
Pollution severity		3	2 2
<b>Rated voltage</b>	<b>V</b>	<b>160</b>	<b>160 320</b>
Rated impulse voltage	kV	2.5	2.5 2.5
<b>UL / CUL (Use Group)</b>		<b>B</b>	<b>C D</b>
<b>Rated voltage</b>	<b>V</b>	<b>300</b>	<b>300</b>
<b>Rated current</b>	<b>A</b>	<b>12</b>	<b>10</b>
<b>AWG conductor</b>	<b>AWG</b>	<b>28-14</b>	
<b>CSA (Use Group)</b>		<b>B</b>	<b>C D</b>
Rated voltage	V	300	300
Rated current	A	10	10
AWG conductor	AWG	28-14	
<b>General data</b>			
Type of insulation material		LCP GF	
UL 94 flammability rating		V-0	
Contact base material		Copper alloy	
Material of contact surface			
Pin dimensions = d	mm	0.35 x 0.8	
Solder eyelet Ø = D	mm	1.1	
Solder eyelet Ø tolerance	mm	+ 0,1	

Product data

IEC: 320 V / 17.5 A / 0.2 - 1.5 mm<sup>2</sup>  
 UL: 300 V / 12 A / AWG 28 - 14



For additional articles and information, refer to [catalog.weidmueller.com](http://catalog.weidmueller.com)

Note:

- Additional push button colours on request
- Operating force of slider max. 40 N
- Rated current related to rated cross-section & min. No. of poles.
- Wire end ferrule with plastic collar to DIN 46228/4
- Wire end ferrule without plastic collar to DIN 46228/1
- P on drawing = pitch
- Rated data refer only to the component itself. Clearance and creepage distances to other components are to be designed in accordance with the relevant application standards.
- Crimping shape "A" for wire end ferrules with PZ 6/5 crimping tool are recommended for the largest cable sizes.

LSF-SMT 3.5/./135

Reflow-compatible PCB terminal



Dimensioned drawing

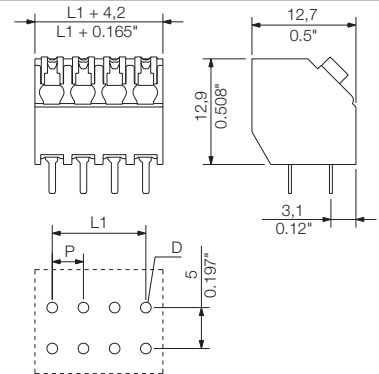

Ordering data

Solder pin length	1.5 mm		3.5 mm	
	Colour	Black	Black	Black
<b>Pitch</b>	<b>3.50 mm</b>			
Pol.	L1 (inch)	Qty.	Order No.	Order No.
2	3.50	0.138	71	1885180000 1885650000
3	7.00	0.276	49	1885190000 1885660000
4	10.50	0.413	37	1885200000 1885670000
5	14.00	0.551	30	1885210000 1885680000
6	17.50	0.689	25	1885220000 1885690000
7	21.00	0.827	21	1885230000 1885700000
8	24.50	0.965	19	1885240000 1885710000
9	28.00	1.102	17	1885250000 1885720000
10	31.50	1.240	15	1885260000 1885730000
11	35.00	1.378	14	1885270000 1885740000
12	38.50	1.516	12	1885280000 1885750000
13	42.00	1.654	11	1885290000 1885760000
14	45.50	1.791	11	1885300000 1885770000
15	49.00	1.929	10	1885310000 1885780000
16	52.50	2.067	9	1885320000 1885790000
17	56.00	2.205	9	1885330000 1885800000
18	59.50	2.343	8	1885340000 1885810000
19	63.00	2.480	8	1885350000 1885820000
20	66.50	2.618	7	1885360000 1885830000
21	70.00	2.756	7	1885370000 1885840000
22	73.50	2.894	7	1885380000 1885850000
23	77.00	3.031	6	1885390000 1885860000
24	80.50	3.169	6	1885400000 1885870000

Representative deratings curve

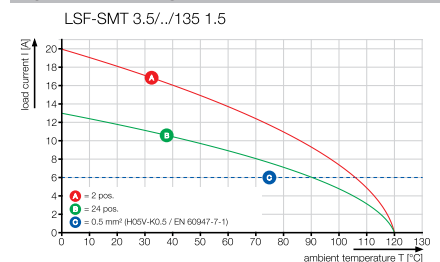

LSF-SMT 3.5/././135 Tape

Reflow-compatible PCB terminal



Dimensioned drawing

Ordering data

Solder pin length		1.5 mm	3.5 mm
Colour		Black	Black
Pitch		3.50 mm	
Pol.	L1 (inch)	Qty.	Order No.
2	3.50 0.138	190	1887550000 1887340000
3	7.00 0.276	190	1887560000 1887350000
4	10.50 0.413	190	1887580000 1887360000
5	14.00 0.551	190	1887630000 1887460000
6	17.50 0.689	190/175	1887640000 1887470000
7	21.00 0.827	190	1887650000 1887480000
8	24.50 0.965	190	1887660000 1887490000
9	28.00 1.102	190	1887670000 1887500000
10	31.50 1.240	190	1887680000 1887510000
11	35.00 1.378	190	1887690000 1887520000
12	38.50 1.516	190	1887700000 1887530000

Belt widths: 32, 44, 56, 72, 88

Additional deratings curves

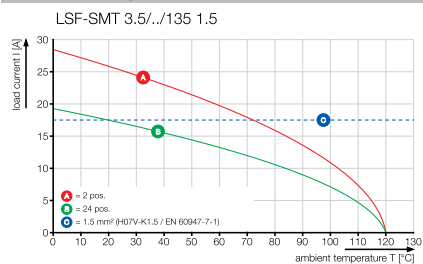

LSF-SMT 3.5/./180

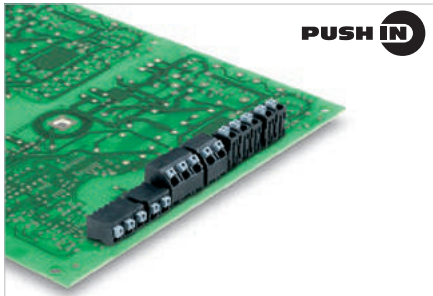

PCB terminal for fully automatic assembly, in 3.5 mm pitch, for THR reflow soldering (SMT) and wave soldering.

- PUSH IN spring connection system for wire cross-sections up to 1.5 mm<sup>2</sup>.
- Form and dimensional stability through the use of LCP insulating material.
- Wire connection and slider operation from the same direction (TOP).
- Packaged in tube or tape-on-reel.
- Pin lengths optimised to 1.5 mm or 3.5 mm.
- Wire outlet direction: 180° version

Technical data

In compliance with IEC 60664-1 / IEC 61984

Clamping range, max.	mm <sup>2</sup>	0.13...1.5
<b>Solid core H05(07) V-U</b>	<b>mm<sup>2</sup></b>	<b>0.2...1.5</b>
Stranded H07 V-R		
Flexible H05(07) V-K	mm <sup>2</sup>	0.2...1.5
Flexible with ferrule	mm <sup>2</sup>	0.25...1.5
Ferrule with plastic collar	mm <sup>2</sup>	0.25...0.75
Stripping length	mm	8
Screwdriver blade	mm	
According to norm		
Tightening torque range		
<b>Rated current, max.</b>	<b>A</b>	<b>17.5 17.5</b>
At ambient temperature	20°C	40°C
For conductor cross-section		
Overtolerance category		III III II
Pollution severity		3 2 2
<b>Rated voltage</b>	<b>V</b>	<b>160 160 320</b>
Rated impulse voltage	kV	2.5 2.5 2.5
<b>UL / CUL (Use Group)</b>		<b>B C D</b>
<b>Rated voltage</b>	<b>V</b>	<b>300 300</b>
<b>Rated current</b>	<b>A</b>	<b>12 10</b>
<b>AWG conductor</b>	<b>AWG</b>	<b>28-14</b>
<b>CSA (Use Group)</b>		<b>B C D</b>
Rated voltage	V	300 300
Rated current	A	10 10
AWG conductor	AWG	28-14

General data

Type of insulation material		LCP GF
UL 94 flammability rating		V-0
Contact base material		Copper alloy
Material of contact surface		
Pin dimensions = d	mm	0.35 x 0.8
Solder eyelet Ø = D	mm	1.1
Solder eyelet Ø tolerance	mm	+ 0,1

Product data

IEC: 320 V / 17.5 A / 0.2 - 1.5 mm<sup>2</sup>  
 UL: 300 V / 12 A / AWG 28 - 14



For additional articles and information, refer to [catalog.weidmuller.com](http://catalog.weidmuller.com)

Note:

- Additional push button colours on request
- Operating force of slider max. 40 N
- Rated current related to rated cross-section & min. No. of poles.
- Wire end ferrule with plastic collar to DIN 46228/4
- Wire end ferrule without plastic collar to DIN 46228/1
- P on drawing = pitch
- Rated data refer only to the component itself. Clearance and creepage distances to other components are to be designed in accordance with the relevant application standards.
- Crimping shape "A" for wire end ferrules with PZ 6/5 crimping tool are recommended for the largest cable sizes.

LSF-SMT 3.5/./180

Reflow-compatible PCB terminal



Dimensioned drawing

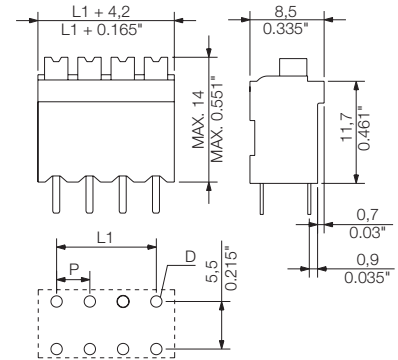

Accessories

Note: Refer to the Accessories chapter for additional accessories.

Screwdriver		Order No.
	SDS 0.4X2.5X75	9009030000
	SDIS 0.4X2.5X75	9008370000

Ordering data

Solder pin length	1.5 mm		3.5 mm	
	Black	Black	Black	Black
<b>Pitch 3.50 mm</b>				
Pol.	L1 (inch)	Qty.	Order No.	Order No.
2	3.50 0.138	71	1870640000	1825640000
3	7.00 0.276	49	1870650000	1825650000
4	10.50 0.413	37	1870660000	1825660000
5	14.00 0.551	30	1870670000	1825670000
6	17.50 0.689	25	1870680000	1825680000
7	21.00 0.827	21	1870690000	1825690000
8	24.50 0.965	19	1870700000	1825700000
9	28.00 1.102	17	1870710000	1825710000
10	31.50 1.240	15	1870720000	1825720000
11	35.00 1.378	14	1870730000	1825730000
12	38.50 1.516	12	1870740000	1825740000
13	42.00 1.654	11	1870750000	1870350000
14	45.50 1.791	11	1870760000	1870360000
15	49.00 1.929	10	1870770000	1870370000
16	52.50 2.067	9	1870790000	1870510000
17	56.00 2.205	9	1870800000	1870520000
18	59.50 2.343	8	1870830000	1870540000
19	63.00 2.480	8	1870840000	1870560000
20	66.50 2.618	7	1870850000	1870570000
21	70.00 2.756	7	1870860000	1870600000
22	73.50 2.894	7	1870870000	1870610000
23	77.00 3.031	6	1870880000	1870620000
24	80.50 3.169	6	1870890000	1870630000

Representative deratings curve

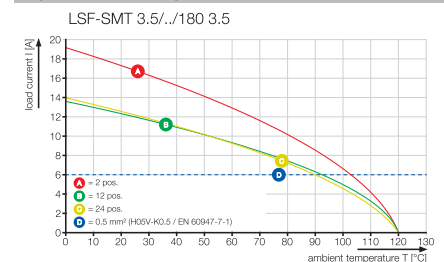

LSF-SMT 3.5/./180 Tape

Reflow-compatible PCB terminal



Dimensioned drawing

Ordering data

Solder pin length		1.5 mm	3.5 mm
Colour		Black	Black
Pitch		3.50 mm	
Pol.	L1 (inch)	Qty.	Order No.
2	3.50	0.138	175 1874490000 1874510000
3	7.00	0.276	175 1874300000 1874520000
4	10.50	0.413	175 1874280000 1874540000
5	14.00	0.551	175 1874310000 1874560000
6	17.50	0.689	175 1874320000 1874590000
7	21.00	0.827	175 1874340000 1874600000
8	24.50	0.965	175 1874350000 1874610000
9	28.00	1.102	175 1874370000 1874620000
10	31.50	1.240	175 1874380000 1874640000
11	35.00	1.378	175 1874400000 1874660000
12	38.50	1.516	175 1874420000 1874680000

Belt widths: 32, 44, 56, 72, 88

Additional deratings curves

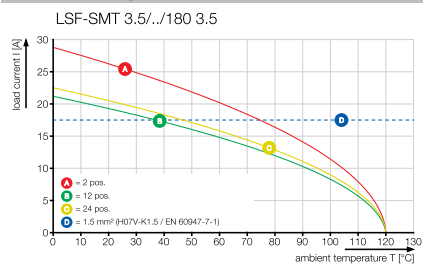

LSF-SMT 3.81/./90

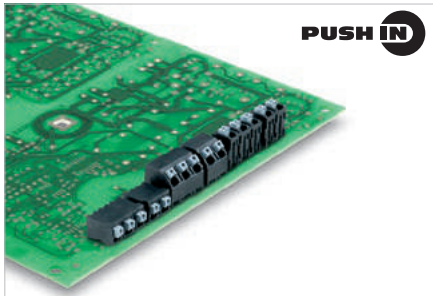

PCB terminal for fully automatic assembly in 3.81 mm pitch, for THR reflow soldering (SMT) and wave soldering.

- PUSH IN spring connection system for wire cross-sections up to 1.5 mm<sup>2</sup>.
- Form and dimensional stability through the use of LCP insulating material.
- Wire connection and slider operation from the same direction (TOP).
- Packaged in tube or tape-on-reel.
- Pin lengths optimised to 1.5 mm or 3.5 mm.
- Wire outlet direction: 90° version

Technical data

In compliance with IEC 60664-1 / IEC 61984

Clamping range, max.	mm <sup>2</sup>	0.13...1.5
<b>Solid core H05(07) V-U</b>	<b>mm<sup>2</sup></b>	<b>0.2...1.5</b>
Stranded H07 V-R		
Flexible H05(07) V-K	mm <sup>2</sup>	0.2...1.5
Flexible with ferrule	mm <sup>2</sup>	0.25...1.5
Ferrule with plastic collar	mm <sup>2</sup>	0.25...0.75
Stripping length	mm	8
Screwdriver blade	mm	
According to norm		
Tightening torque range		
<b>Rated current, max.</b>	<b>A</b>	<b>17.5 17.5</b>
At ambient temperature	20°C	40°C
For conductor cross-section		
Overvoltage category		III III II
Pollution severity		3 2 2
<b>Rated voltage</b>	<b>V</b>	<b>160 160 320</b>
Rated impulse voltage	kV	2.5 2.5 2.5
<b>UL / CUL (Use Group)</b>	<b>B C D</b>	<b>D</b>
<b>Rated voltage</b>	<b>V</b>	<b>300 300</b>
<b>Rated current</b>	<b>A</b>	<b>12 10</b>
<b>AWG conductor</b>	<b>AWG</b>	<b>28-14</b>
<b>CSA (Use Group)</b>	<b>B C D</b>	<b>D</b>
Rated voltage	V	300 300
Rated current	A	10 10
AWG conductor	AWG	28-14
<b>General data</b>		
Type of insulation material		LCP GF
UL 94 flammability rating		V-0
Contact base material		Copper alloy
Material of contact surface		
Pin dimensions = d	mm	0.35 x 0.8
Solder eyelet Ø = D	mm	1.1
Solder eyelet Ø tolerance	mm	+ 0,1

Product data

IEC: 320 V / 17.5 A / 0.2 - 1.5 mm<sup>2</sup>  
 UL: 300 V / 12 A / AWG 28 - 14



For additional articles and information, refer to [catalog.weidmuller.com](http://catalog.weidmuller.com)

Note:

- Additional push button colours on request
- Operating force of slider max. 40 N
- Rated current related to rated cross-section & min. No. of poles.
- Wire end ferrule with plastic collar to DIN 46228/4
- Wire end ferrule without plastic collar to DIN 46228/1
- P on drawing = pitch
- Rated data refer only to the component itself. Clearance and creepage distances to other components are to be designed in accordance with the relevant application standards.
- Crimping shape "A" for wire end ferrules with PZ 6/5 crimping tool are recommended for the largest cable sizes.

LSF-SMT 3.81/./90

Reflow-compatible PCB terminal



Dimensioned drawing

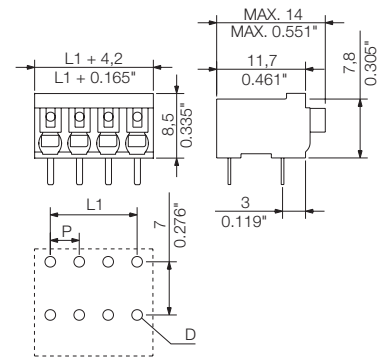

Accessories

Note: Refer to the Accessories chapter for additional accessories.

Screwdriver		Order No.
	SDS 0.4X2.5X75	9009030000
	SDIS 0.4X2.5X75	9008370000

Ordering data

Solder pin length	1.5 mm		3.5 mm	
	Black		Black	
<b>Pitch</b>	<b>3.81 mm</b>			
Pol.	L1 (inch)	Qty.	Order No.	Order No.
2	3.81 0.150	69	1869360000	1824620000
3	7.62 0.300	46	1869370000	1824630000
4	11.43 0.450	35	1869380000	1824640000
5	15.24 0.600	28	1869390000	1824650000
6	19.05 0.750	23	1869400000	1824660000
7	22.86 0.900	20	1869410000	1824690000
8	26.67 1.050	17	1869420000	1824700000
9	30.48 1.200	15	1869430000	1824710000
10	34.29 1.350	14	1869440000	1824720000
11	38.10 1.500	13	1869450000	1824730000
12	41.91 1.650	12	1869460000	1825300000
13	45.72 1.800	11	1869470000	1871200000
14	49.53 1.950	10	1869480000	1871210000
15	53.34 2.100	9	1869500000	1871220000
16	57.15 2.250	9	1869510000	1871230000
17	60.96 2.400	8	1869520000	1871240000
18	64.77 2.550	8	1869530000	1871250000
19	68.58 2.700	7	1869540000	1871260000
20	72.39 2.850	7	1869550000	1871270000
21	76.20 3.000	6	1869560000	1871280000
22	80.01 3.150	6	1869570000	1871290000
23	83.82 3.300	6	1869580000	1871300000
24	87.63 3.450	6	1869590000	1871310000

Representative deratings curve

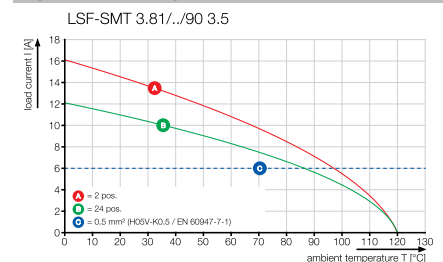

LSF-SMT 3.81../90 Tape

Reflow-compatible PCB terminal



Dimensioned drawing

Ordering data

Solder pin length		1.5 mm	3.5 mm		
Colour		Black	Black		
<b>Pitch 3.81 mm</b>					
Pol.	L1 (inch)	Qty.	Order No.		
2	3.81	0.150	265	1875170000	1875920000
3	7.62	0.300	265	1875230000	1875930000
4	11.43	0.450	265	1875240000	1875940000
5	15.24	0.600	265	1875250000	1875950000
6	19.05	0.750	265	1875260000	1875960000
7	22.86	0.900	265	1875270000	1875970000
8	26.67	1.050	265	1875280000	1875980000
9	30.48	1.200	265	1875290000	1875990000
10	34.29	1.350	265	1875300000	1876000000
11	38.10	1.500	265	1875310000	1876010000

Belt widths: 32, 44, 56, 72, 88

Additional deratings curves

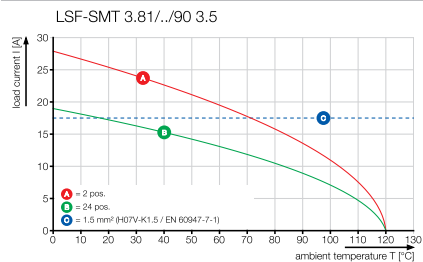

LSF-SMT 3.81.././135

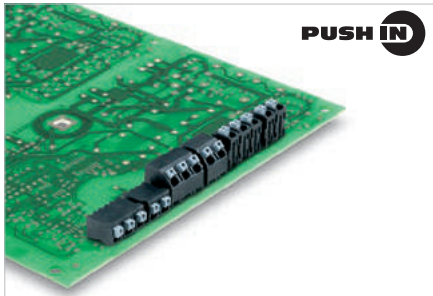

PCB terminal for fully automatic assembly in 3.81 mm pitch, for THR reflow soldering (SMT) and wave soldering.

- PUSH IN spring connection system for wire cross-sections up to 1.5 mm<sup>2</sup>.
- Form and dimensional stability through the use of LCP insulating material.
- Wire connection and slider operation from the same direction (TOP).
- Packaged in tube or tape-on-reel.
- Pin lengths optimised to 1.5 mm or 3.5 mm.
- Wire outlet direction of 135°

Technical data

In compliance with IEC 60664-1 / IEC 61984			
Clamping range, max.	mm <sup>2</sup>	0.13...1.5	
<b>Solid core H05(07) V-U</b>	<b>mm<sup>2</sup></b>	<b>0.2...1.5</b>	
Stranded H07 V-R			
Flexible H05(07) V-K	mm <sup>2</sup>	0.2...1.5	
Flexible with ferrule	mm <sup>2</sup>	0.25...1.5	
Ferrule with plastic collar	mm <sup>2</sup>	0.25...0.75	
Stripping length	mm	8	
Screwdriver blade	mm		
According to norm			
Tightening torque range			
<b>Rated current, max.</b>	<b>A</b>	<b>17.5</b>	<b>17.5</b>
At ambient temperature		20°C	40°C
For conductor cross-section			
Overvoltage category		III	III II
Pollution severity		3	2 2
<b>Rated voltage</b>	<b>V</b>	<b>160</b>	<b>160 320</b>
Rated impulse voltage	kV	2.5	2.5 2.5
<b>UL / CUL (Use Group)</b>		<b>B</b>	<b>C D</b>
<b>Rated voltage</b>	<b>V</b>	<b>300</b>	<b>300</b>
<b>Rated current</b>	<b>A</b>	<b>12</b>	<b>10</b>
<b>AWG conductor</b>	<b>AWG</b>	<b>28-14</b>	
<b>CSA (Use Group)</b>		<b>B</b>	<b>C D</b>
Rated voltage	V	300	300
Rated current	A	10	10
AWG conductor	AWG	28-14	
General data			
Type of insulation material		LCP GF	
UL 94 flammability rating		V-0	
Contact base material		Copper alloy	
Material of contact surface			
Pin dimensions = d	mm	0.35 x 0.8	
Solder eyelet Ø = D	mm	1.1	
Solder eyelet Ø tolerance	mm	+ 0,1	

Product data

IEC: 320 V / 17.5 A / 0.2 - 1.5 mm<sup>2</sup>  
 UL: 300 V / 12 A / AWG 28 - 14



For additional articles and information, refer to [catalog.weidmuller.com](http://catalog.weidmuller.com)

Note:

- Additional push button colours on request
- Operating force of slider max. 40 N
- Rated current related to rated cross-section & min. No. of poles.
- Wire end ferrule with plastic collar to DIN 46228/4
- Wire end ferrule without plastic collar to DIN 46228/1
- P on drawing = pitch
- Rated data refer only to the component itself. Clearance and creepage distances to other components are to be designed in accordance with the relevant application standards.
- Crimping shape "A" for wire end ferrules with PZ 6/5 crimping tool are recommended for the largest cable sizes.

LSF-SMT 3.81.././135

Reflow-compatible PCB terminal



Dimensioned drawing

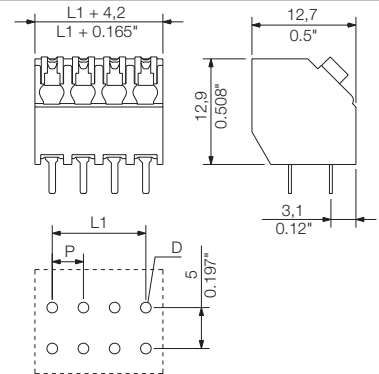

Ordering data

Solder pin length	1.5 mm		3.5 mm	
	Colour	Black	Black	Black
<b>Pitch</b>	<b>3.81 mm</b>			
Pol.	L1 (inch)	Qty.	Order No.	Order No.
2	3.81 0.150	69	1885410000	1885880000
3	7.62 0.300	46	1885420000	1885890000
4	11.43 0.450	35	1885430000	1885900000
5	15.24 0.600	28	1885440000	1885910000
6	19.05 0.750	23	1885450000	1885920000
7	22.86 0.900	20	1885460000	1885930000
8	26.67 1.050	17	1885470000	1885940000
9	30.48 1.200	15	1885480000	1885950000
10	34.29 1.350	14	1885490000	1885960000
11	38.10 1.500	13	1885510000	1885970000
12	41.91 1.650	12	1885520000	1885980000
13	45.72 1.800	11	1885530000	1885990000
14	49.53 1.950	10	1885540000	1886000000
15	53.34 2.100	9	1885550000	1886010000
16	57.15 2.250	9	1885560000	1886020000
17	60.96 2.400	8	1885570000	1886030000
18	64.77 2.550	8	1885580000	1886040000
19	68.58 2.700	7	1885590000	1886050000
20	72.39 2.850	7	1885600000	1886060000
21	76.20 3.000	6	1885610000	1886070000
22	80.01 3.150	6	1885620000	1886080000
23	83.82 3.300	6	1885630000	1886090000
24	87.63 3.450	6	1885640000	1886100000

Representative deratings curve

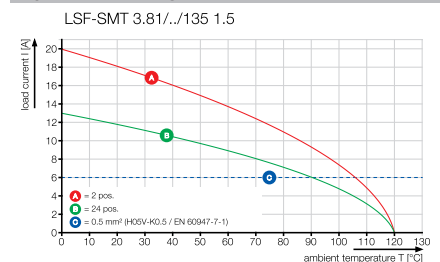



LSF-SMT 3.81../135 Tape

Reflow-compatible PCB terminal



Dimensioned drawing

Ordering data

Solder pin length		1.5 mm	3.5 mm		
Colour		Black	Black		
Pitch		3.81 mm			
Pol.	L1 (inch)	Qty.	Order No.		
2	3.81	0.150	175	1888450000	1888320000
3	7.62	0.300	190	1888460000	1888330000
4	11.43	0.450	190	1888470000	1888340000
5	15.24	0.600	190	1888480000	1888380000
6	19.05	0.750	190	1888490000	1888390000
7	22.86	0.900	190	1888500000	1888400000
8	26.67	1.050	190	1888510000	1888410000
9	30.48	1.200	190	1888520000	1888420000
10	34.29	1.350	190	1888530000	1888430000
11	38.10	1.500	190	1888540000	1888440000

Belt widths: 32, 44, 56, 72, 88

Additional deratings curves

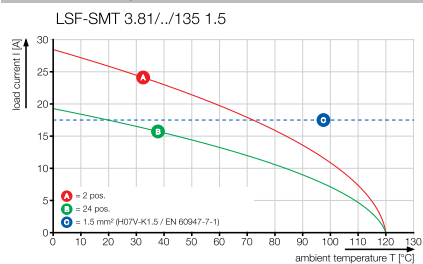

LSF-SMT 3.81/././180

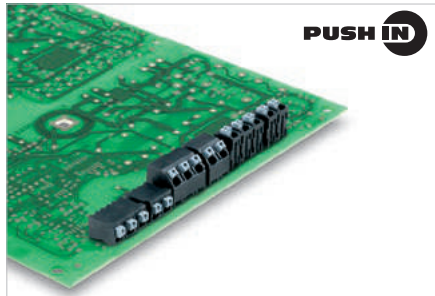

PCB terminal for fully automatic assembly in 3.81 mm pitch, for THR reflow soldering (SMT) and wave soldering.

- PUSH IN spring connection system for wire cross-sections up to 1.5 mm<sup>2</sup>.
- Form and dimensional stability through the use of LCP insulating material.
- Wire connection and slider operation from the same direction (TOP).
- Packaged in tube or tape-on-reel.
- Pin lengths optimised to 1.5 mm or 3.5 mm.
- Wire outlet direction: 180° version

Technical data

In compliance with IEC 60664-1 / IEC 61984

Clamping range, max.	mm <sup>2</sup>	0.13...1.5
<b>Solid core H05(07) V-U</b>	<b>mm<sup>2</sup></b>	<b>0.2...1.5</b>
Stranded H07 V-R		
Flexible H05(07) V-K	mm <sup>2</sup>	0.2...1.5
Flexible with ferrule	mm <sup>2</sup>	0.25...1.5
Ferrule with plastic collar	mm <sup>2</sup>	0.25...0.75
Stripping length	mm	8
Screwdriver blade	mm	
According to norm		
Tightening torque range		
<b>Rated current, max.</b>	<b>A</b>	<b>17.5 17.5</b>
At ambient temperature	20°C	40°C
For conductor cross-section		
Overvoltage category		III III II
Pollution severity		3 2 2
<b>Rated voltage</b>	<b>V</b>	<b>160 160 320</b>
Rated impulse voltage	kV	2.5 2.5 2.5
<b>UL / CUL (Use Group)</b>	<b>B C D</b>	<b>B C D</b>
<b>Rated voltage</b>	<b>V</b>	<b>300 300</b>
<b>Rated current</b>	<b>A</b>	<b>12 10</b>
<b>AWG conductor</b>	<b>AWG</b>	<b>28-14</b>
<b>CSA (Use Group)</b>	<b>B C D</b>	<b>B C D</b>
Rated voltage	V	300 300
Rated current	A	10 10
AWG conductor	AWG	28-14

General data

Type of insulation material		LCP GF
UL 94 flammability rating		V-0
Contact base material		Copper alloy
Material of contact surface		
Pin dimensions = d	mm	0.35 x 0.8
Solder eyelet Ø = D	mm	1.1
Solder eyelet Ø tolerance	mm	+ 0,1

Product data

IEC: 320 V / 17.5 A / 0.2 - 1.5 mm<sup>2</sup>  
UL: 300 V / 12 A / AWG 28 - 14



For additional articles and information, refer to [catalog.weidmuller.com](http://catalog.weidmuller.com)

Note:

- Additional push button colours on request
- Operating force of slider max. 40 N
- Rated current related to rated cross-section & min. No. of poles.
- Wire end ferrule with plastic collar to DIN 46228/4
- Wire end ferrule without plastic collar to DIN 46228/1
- P on drawing = pitch
- Rated data refer only to the component itself. Clearance and creepage distances to other components are to be designed in accordance with the relevant application standards.
- Crimping shape "A" for wire end ferrules with PZ 6/5 crimping tool are recommended for the largest cable sizes.

LSF-SMT 3.81/././180

Reflow-compatible PCB terminal



Dimensioned drawing

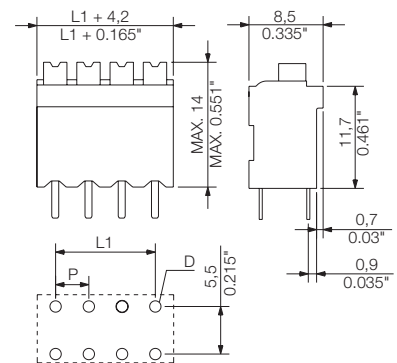

Accessories

Note: Refer to the Accessories chapter for additional accessories.

Screwdriver		Order No.
	SDS 0.4X2.5X75	9009030000
	SDIS 0.4X2.5X75	9008370000

Ordering data

Solder pin length	1.5 mm		3.5 mm	
	Black	Black	Black	Black
<b>Pitch 3.81 mm</b>				
Pol.	L1 (inch)	Qty.	Order No.	Order No.
2	3.81 0.150	69	1869890000	1825790000
3	7.62 0.300	46	1869900000	1825800000
4	11.43 0.450	35	1869910000	1825810000
5	15.24 0.600	28	1869920000	1825820000
6	19.05 0.750	23	1869930000	1825830000
7	22.86 0.900	20	1869940000	1825840000
8	26.67 1.050	17	1869950000	1825850000
9	30.48 1.200	15	1869960000	1825870000
10	34.29 1.350	14	1869970000	1825880000
11	38.10 1.500	13	1870000000	1825890000
12	41.91 1.650	12	1870010000	1825920000
13	45.72 1.800	11	1870020000	1870900000
14	49.53 1.950	10	1870030000	1870910000
15	53.34 2.100	9	1870040000	1870920000
16	57.15 2.250	9	1870050000	1870930000
17	60.96 2.400	8	1870060000	1870940000
18	64.77 2.550	8	1870070000	1870950000
19	68.58 2.700	7	1870080000	1870960000
20	72.39 2.850	7	1870090000	1870970000
21	76.20 3.000	6	1870100000	1870980000
22	80.01 3.150	6	1870110000	1870990000
23	83.82 3.300	6	1870120000	1871000000
24	87.63 3.450	6	1870130000	1871010000

Representative deratings curve

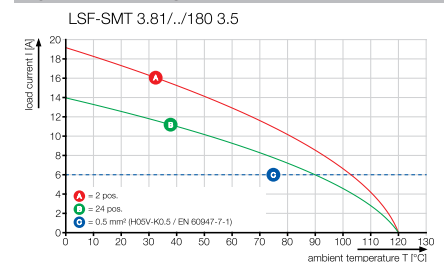

LSF-SMT 3.81../180 Tape

Reflow-compatible PCB terminal



Dimensioned drawing

Ordering data

Solder pin length		1.5 mm	3.5 mm
Colour		Black	Black
Pitch		3.81 mm	
Pol.	L1 (inch)	Qty.	Order No.
2	3.81	0.150	175 1875320000 1875550000
3	7.62	0.300	175 1875330000 1875570000
4	11.43	0.450	175 1875340000 1875590000
5	15.24	0.600	175 1875350000 1875650000
6	19.05	0.750	175 1875360000 1875670000
7	22.86	0.900	175 1875370000 1875680000
8	26.67	1.050	175 1875380000 1875710000
9	30.48	1.200	175 1875390000 1875730000
10	34.29	1.350	175 1875400000 1875760000
11	38.10	1.500	175 1875410000 1875810000

Belt widths: 32, 44, 56, 72, 88

Additional deratings curves

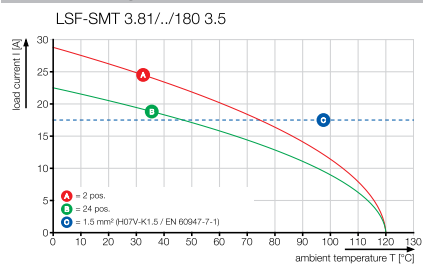

LSF-SMT 5.00/./90

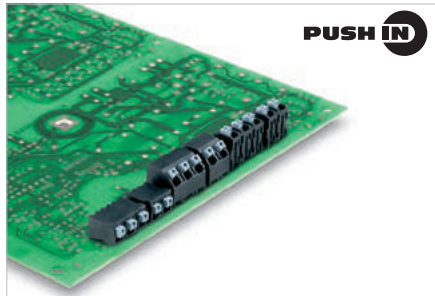

PCB terminal for fully automatic assembly in 5.00 mm pitch, for THR reflow soldering (SMT) and wave soldering.

- PUSH IN spring connection system for wire cross-sections up to 1.5 mm<sup>2</sup>. Form and dimensional stability through the use of LCP insulating material.
- Wire connection and slider operation from the same direction (TOP).
- Packaged in tube or tape-on-reel.
- Pin lengths optimised to 1.5 mm or 3.5 mm.
- Wire outlet direction: 90° version

Technical data

In compliance with IEC 60664-1 / IEC 61984			
Clamping range, max.	mm <sup>2</sup>	0.13...1.5	
<b>Solid core H05(07) V-U</b>	<b>mm<sup>2</sup></b>	<b>0.2...1.5</b>	
Stranded H07 V-R			
Flexible H05(07) V-K	mm <sup>2</sup>	0.2...1.5	
Flexible with ferrule	mm <sup>2</sup>	0.25...1.5	
Ferrule with plastic collar	mm <sup>2</sup>	0.25...0.75	
Stripping length	mm	8	
Screwdriver blade	mm		
According to norm			
Tightening torque range			
<b>Rated current, max.</b>	<b>A</b>	<b>17.5</b>	<b>17.5</b>
At ambient temperature		20°C	40°C
For conductor cross-section			
Overvoltage category		III	III II
Pollution severity		3	2 2
<b>Rated voltage</b>	<b>V</b>	<b>250</b>	<b>320 500</b>
Rated impulse voltage	kV	4	4 4
<b>UL / CUL (Use Group)</b>		<b>B</b>	<b>C D</b>
<b>Rated voltage</b>	<b>V</b>	<b>300</b>	<b>300</b>
<b>Rated current</b>	<b>A</b>	<b>12</b>	<b>10</b>
<b>AWG conductor</b>	<b>AWG</b>	<b>28-14</b>	
<b>CSA (Use Group)</b>		<b>B</b>	<b>C D</b>
Rated voltage	V	300	300
Rated current	A	10	10
AWG conductor	AWG	28-14	
<b>General data</b>			
Type of insulation material		LCP GF	
UL 94 flammability rating		V-0	
Contact base material		Copper alloy	
Material of contact surface			
Pin dimensions = d	mm	0.35 x 0.8	
Solder eyelet Ø = D	mm	1.1	
Solder eyelet Ø tolerance	mm	+ 0,1	

Product data

IEC: 500 V / 17.5 A / 0.2 - 1.5 mm<sup>2</sup>  
 UL: 300 V / 12 A / AWG 28 - 14



For additional articles and information, refer to [catalog.weidmueller.com](http://catalog.weidmueller.com)

Note:

- Additional push button colours on request
- Operating force of slider max. 40 N
- Rated current related to rated cross-section & min. No. of poles.
- Wire end ferrule with plastic collar to DIN 46228/4
- Wire end ferrule without plastic collar to DIN 46228/1
- P on drawing = pitch
- Rated data refer only to the component itself. Clearance and creepage distances to other components are to be designed in accordance with the relevant application standards.
- Crimping shape "A" for wire end ferrules with PZ 6/5 crimping tool are recommended for the largest cable sizes.

LSF-SMT 5.00/./90

Reflow-compatible PCB terminal



Dimensioned drawing

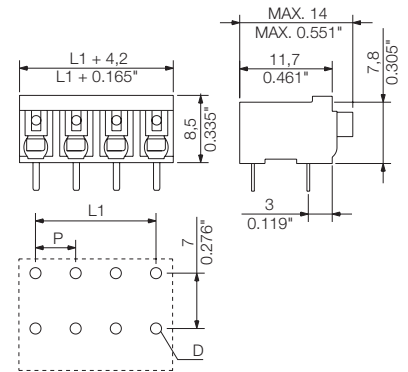

Accessories

Note: Refer to the Accessories chapter for additional accessories.

Screwdriver		Order No.
	SDS 0.4X2.5X75	9009030000
	SDIS 0.4X2.5X75	9008370000

Ordering data

Solder pin length	1.5 mm		3.5 mm		
	Black		Black		
<b>Pitch</b>	<b>5.00 mm</b>				
Pol.	L1	(inch)	Qty.	Order No.	Order No.
2	5.00	0.197	60	1869600000	1824740000
3	10.00	0.394	39	1869610000	1824750000
4	15.00	0.591	28	1869620000	1824760000
5	20.00	0.788	22	1869630000	1824770000
6	25.00	0.985	18	1869640000	1824780000
7	30.00	1.182	16	1869650000	1824790000
8	35.00	1.379	14	1869660000	1824800000

Representative deratings curve

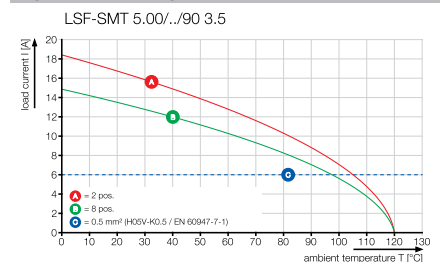

LSF-SMT 5.00/./90 Tape

Reflow-compatible PCB terminal



Dimensioned drawing

Ordering data

Solder pin length		1.5 mm	3.5 mm
Colour		Black	Black
Pitch		5.00 mm	
Pol.	L1 (inch)	Qty.	Order No.
2	5.00 0.197	265	1876240000 1876430000
3	10.00 0.394	265	1876260000 1876510000
4	15.00 0.591	265	1876270000 1876530000
5	20.00 0.788	265	1876280000 1876550000
6	25.00 0.985	265	1876300000 1876560000
7	30.00 1.182	265	1876330000 1876540000
8	35.00 1.379	265	1876350000 1876520000

Belt widths: 32, 44, 56, 72, 88

Additional deratings curves

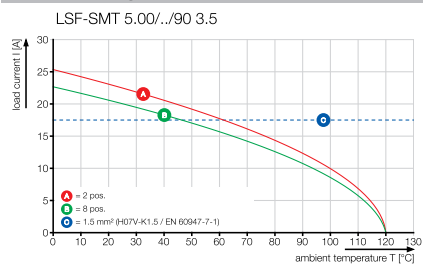

LSF-SMT 5.00/././135

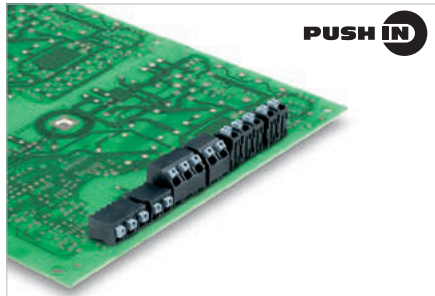

PCB terminal for fully automatic assembly in 5.00 mm pitch, for THR reflow soldering (SMT) and wave soldering.

- PUSH IN spring connection system for wire cross-sections up to 1.5 mm<sup>2</sup>.
- Form and dimensional stability through the use of LCP insulating material.
- Wire connection and slider operation from the same direction (TOP).
- Packaged in tube or tape-on-reel.
- Pin lengths optimised to 1.5 mm or 3.5 mm.
- Wire outlet direction: 135° version

Technical data

In compliance with IEC 60664-1 / IEC 61984			
Clamping range, max.	mm <sup>2</sup>	0.13...1.5	
<b>Solid core H05(07) V-U</b>	<b>mm<sup>2</sup></b>	<b>0.2...1.5</b>	
Stranded H07 V-R			
Flexible H05(07) V-K	mm <sup>2</sup>	0.2...1.5	
Flexible with ferrule	mm <sup>2</sup>	0.25...1.5	
Ferrule with plastic collar	mm <sup>2</sup>	0.25...0.75	
Stripping length	mm	8	
Screwdriver blade	mm		
According to norm			
Tightening torque range			
<b>Rated current, max.</b>	<b>A</b>	<b>17.5</b>	<b>17.5</b>
At ambient temperature		20°C	40°C
For conductor cross-section			
Overtoltage category		III	III II
Pollution severity		3	2 2
<b>Rated voltage</b>	<b>V</b>	<b>250</b>	<b>320 500</b>
Rated impulse voltage	kV	4	4 4
<b>UL / CUL (Use Group)</b>		<b>B</b>	<b>C D</b>
<b>Rated voltage</b>	<b>V</b>	<b>300</b>	<b>300</b>
<b>Rated current</b>	<b>A</b>	<b>12</b>	<b>10</b>
<b>AWG conductor</b>	<b>AWG</b>	<b>28-14</b>	
<b>CSA (Use Group)</b>		<b>B</b>	<b>C D</b>
Rated voltage	V	300	300
Rated current	A	10	10
AWG conductor	AWG	28-14	
General data			
Type of insulation material		LCP GF	
UL 94 flammability rating		V-0	
Contact base material		Copper alloy	
Material of contact surface			
Pin dimensions = d	mm	0.35 x 0.8	
Solder eyelet Ø = D	mm	1.1	
Solder eyelet Ø tolerance	mm	+ 0,1	

Product data

IEC: 500 V / 17.5 A / 0.2 - 1.5 mm<sup>2</sup>  
 UL: 300 V / 12 A / AWG 28 - 14



For additional articles and information, refer to [catalog.weidmuller.com](http://catalog.weidmuller.com)

Note:

- Additional push button colours on request
- Operating force of slider max. 40 N
- Rated current related to rated cross-section & min. No. of poles.
- Wire end ferrule with plastic collar to DIN 46228/4
- Wire end ferrule without plastic collar to DIN 46228/1
- P on drawing = pitch
- Rated data refer only to the component itself. Clearance and creepage distances to other components are to be designed in accordance with the relevant application standards.
- Crimping shape "A" for wire end ferrules with PZ 6/5 crimping tool are recommended for the largest cable sizes.

LSF-SMT 5.00/././135

Reflow-compatible PCB terminal



Dimensioned drawing

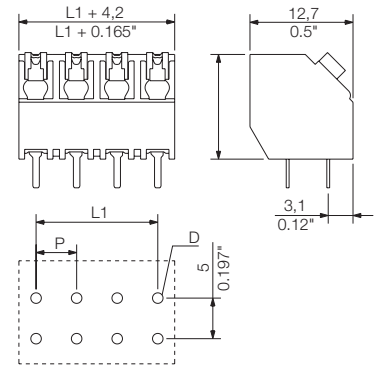

Ordering data

Solder pin length	1.5 mm		3.5 mm			
	Black		Black			
<b>Pitch 5.00 mm</b>	<b>Pol.</b>	<b>L1 (inch)</b>	<b>Qty.</b>	<b>Order No.</b>	<b>Order No.</b>	
	2	5.00	0.197	60	1884530000	1884340000
	3	10.00	0.394	39	1884540000	1884370000
	4	15.00	0.591	28	1884550000	1884380000
	5	20.00	0.787	22	1884560000	1884390000
	6	25.00	0.984	18	1884570000	1884400000
	7	30.00	1.181	16	1884580000	1884410000
	8	35.00	1.378	14	1884590000	1884420000
	9	40.00	1.575	12	1884600000	1884430000
	10	45.00	1.772	11	1884660000	1884440000
	11	50.00	1.969	10	1884670000	1884450000
	12	55.00	2.165	9	1884680000	1884460000
	13	60.00	2.362	8	1884690000	1884470000
	14	65.00	2.559	8	1884700000	1884500000
	15	70.00	2.756	7	1884710000	1884510000
	16	75.00	2.953	6	1884720000	1884520000

Accessories

Note: Refer to the Accessories chapter for additional accessories.

Screwdriver		Order No.
	SDS 0.4X2.5X75	9009030000
	SDIS 0.4X2.5X75	9008370000

Representative deratings curve

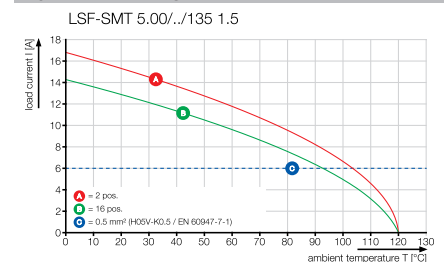

LSF-SMT 5.00/././135 Tape

Reflow-compatible PCB terminal



Dimensioned drawing

Ordering data

Solder pin length		1.5 mm	3.5 mm
Colour		Black	Black
Pitch		5.00 mm	
Pol.	L1 (inch)	Qty.	Order No.
2	5.00 0.197	190	1888570000 1888640000
3	10.00 0.394	190	1888580000 1888650000
4	15.00 0.591	190	1888590000 1888660000
5	20.00 0.787	190	1888600000 1888670000
6	25.00 0.984	190	1888610000 1888680000
7	30.00 1.181	190	1888620000 1888690000
8	35.00 1.378	190	1888630000 1888700000

Belt widths: 32, 44, 56, 72, 88

Additional deratings curves

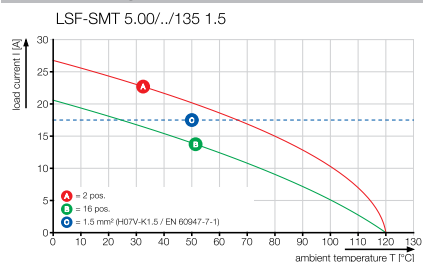

LSF-SMT 5.00/././180

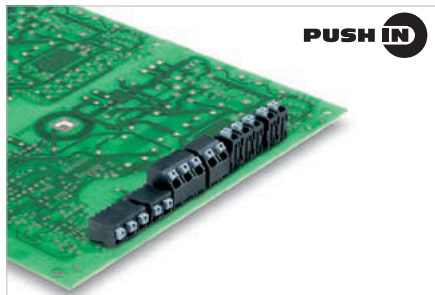

PCB terminal for fully automatic assembly in 5.00 mm pitch, for THR reflow soldering (SMT) and wave soldering.

- PUSH IN spring connection system for wire cross-sections up to 1.5 mm<sup>2</sup>.
- Form and dimensional stability through the use of LCP insulating material.
- Wire connection and slider operation from the same direction (TOP).
- Packaged in tube or tape-on-reel.
- Pin lengths optimised to 1.5 mm or 3.5 mm.
- Wire outlet direction: 180° version

Technical data

In compliance with IEC 60664-1 / IEC 61984

Clamping range, max.	mm <sup>2</sup>	0.13...1.5
<b>Solid core H05(07) V-U</b>	<b>mm<sup>2</sup></b>	<b>0.2...1.5</b>
Stranded H07 V-R		
Flexible H05(07) V-K	mm <sup>2</sup>	0.2...1.5
Flexible with ferrule	mm <sup>2</sup>	0.25...1.5
Ferrule with plastic collar	mm <sup>2</sup>	0.25...0.75
Stripping length	mm	8
Screwdriver blade	mm	
According to norm		
Tightening torque range		
<b>Rated current, max.</b>	<b>A</b>	<b>17.5 17.5</b>
At ambient temperature	20°C	40°C
For conductor cross-section		
Overtoltage category		III III II
Pollution severity		3 2 2
<b>Rated voltage</b>	<b>V</b>	<b>250 320 500</b>
Rated impulse voltage	kV	4 4 4
<b>UL / CUL (Use Group)</b>	<b>B C D</b>	
<b>Rated voltage</b>	<b>V</b>	<b>300 300</b>
<b>Rated current</b>	<b>A</b>	<b>12 10</b>
<b>AWG conductor</b>	<b>AWG</b>	<b>28-14</b>
<b>CSA (Use Group)</b>	<b>B C D</b>	
Rated voltage	V	300 300
Rated current	A	10 10
AWG conductor	AWG	28-14
<b>General data</b>		
Type of insulation material		LCP GF
UL 94 flammability rating		V-0
Contact base material		Copper alloy
Material of contact surface		
Pin dimensions = d	mm	0.35 x 0.8
Solder eyelet Ø = D	mm	1.1
Solder eyelet Ø tolerance	mm	+ 0,1

Product data

IEC: 500 V / 17.5 A / 0.2 - 1.5 mm<sup>2</sup>  
 UL: 300 V / 12 A / AWG 28 - 14



For additional articles and information, refer to [catalog.weidmueller.com](http://catalog.weidmueller.com)

Note:

- Additional push button colours on request
- Operating force of slider max. 40 N
- Rated current related to rated cross-section & min. No. of poles.
- Wire end ferrule with plastic collar to DIN 46228/4
- Wire end ferrule without plastic collar to DIN 46228/1
- P on drawing = pitch
- Rated data refer only to the component itself. Clearance and creepage distances to other components are to be designed in accordance with the relevant application standards.
- Crimping shape "A" for wire end ferrules with PZ 6/5 crimping tool are recommended for the largest cable sizes.

LSF-SMT 5.00/././180

Reflow-compatible PCB terminal



Dimensioned drawing

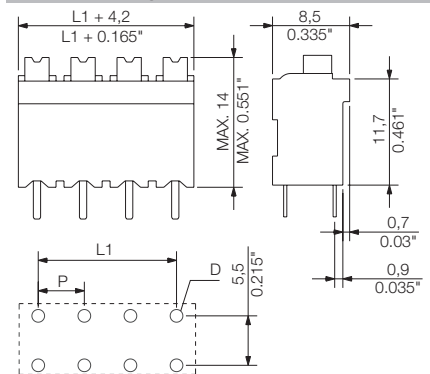

Accessories

Note: Refer to the Accessories chapter for additional accessories.

Screwdriver		Order No.
	SDS 0.4X2.5X75	9009030000
	SDIS 0.4X2.5X75	9008370000

Ordering data

Solder pin length	1.5 mm		3.5 mm		
	Black		Black		
<b>Pitch</b>	<b>5.00 mm</b>				
Pol.	L1	(inch)	Qty.	Order No.	Order No.
2	5.00	0.197	60	1870140000	1825960000
3	10.00	0.394	39	1870150000	1825970000
4	15.00	0.591	28	1870160000	1825980000
5	20.00	0.787	22	1870170000	1825990000
6	25.00	0.984	18	1870180000	1826000000
7	30.00	1.181	16	1870190000	1826010000
8	35.00	1.378	14	1870200000	1826020000

Representative deratings curve

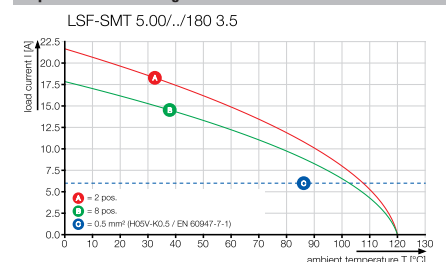



LSF-SMT 5.00/./180 Tape

Reflow-compatible PCB terminal



Dimensioned drawing

Ordering data

Solder pin length		1.5 mm	3.5 mm		
Colour		Black	Black		
Pitch		5.00 mm			
Pol.	L1 (inch)	Qty.	Order No.		
2	5.00	0.197	175	1876020000	1876110000
3	10.00	0.394	175	1876030000	1876130000
4	15.00	0.591	175	1876050000	1876140000
5	20.00	0.787	175	1876060000	1876160000
6	25.00	0.984	175	1876070000	1876200000
7	30.00	1.181	175	1876080000	1876220000
8	35.00	1.378	175	1876090000	1876230000

Belt widths: 32, 44, 56, 72, 88

Additional deratings curves

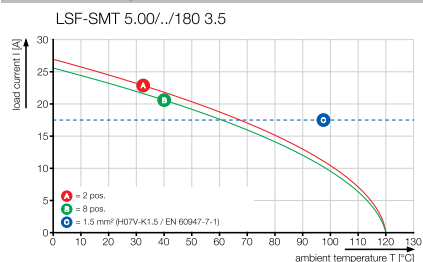

LSF-SMT 5.08/./90

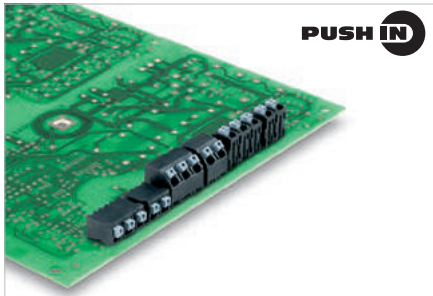

PCB terminal for fully automatic assembly in 5.08 mm pitch, for THR reflow soldering (SMT) and wave soldering.

- PUSH IN spring connection system for wire cross-sections up to 1.5 mm<sup>2</sup>.
- Form and dimensional stability through the use of LCP insulating material.
- Wire connection and slider operation from the same direction (TOP).
- Packaged in tube or tape-on-reel.
- Pin lengths optimised to 1.5 mm or 3.5 mm.
- Wire outlet direction: 90° version

Technical data

In compliance with IEC 60664-1 / IEC 61984			
Clamping range, max.	mm <sup>2</sup>	0.13...1.5	
<b>Solid core H05(07) V-U</b>	<b>mm<sup>2</sup></b>	<b>0.2...1.5</b>	
Stranded H07 V-R			
Flexible H05(07) V-K	mm <sup>2</sup>	0.2...1.5	
Flexible with ferrule	mm <sup>2</sup>	0.25...1.5	
Ferrule with plastic collar	mm <sup>2</sup>	0.25...0.75	
Stripping length	mm	8	
Screwdriver blade	mm		
According to norm			
Tightening torque range			
<b>Rated current, max.</b>	<b>A</b>	<b>17.5</b>	<b>17.5</b>
At ambient temperature		20°C	40°C
For conductor cross-section			
Overtoltage category		III	III II
Pollution severity		3	2 2
<b>Rated voltage</b>	<b>V</b>	<b>250</b>	<b>320 500</b>
Rated impulse voltage	kV	4	4 4
<b>UL / CUL (Use Group)</b>		<b>B</b>	<b>C D</b>
<b>Rated voltage</b>	<b>V</b>	<b>300</b>	<b>300</b>
<b>Rated current</b>	<b>A</b>	<b>12</b>	<b>10</b>
<b>AWG conductor</b>	<b>AWG</b>	<b>28-14</b>	
<b>CSA (Use Group)</b>		<b>B</b>	<b>C D</b>
Rated voltage	V	300	300
Rated current	A	10	10
AWG conductor	AWG	28-14	
<b>General data</b>			
Type of insulation material		LCP GF	
UL 94 flammability rating		V-0	
Contact base material		Copper alloy	
Material of contact surface			
Pin dimensions = d	mm	0.35 x 0.8	
Solder eyelet Ø = D	mm	1.1	
Solder eyelet Ø tolerance	mm	+ 0,1	

5.08

90°

1.5 mm<sup>2</sup>

Product data

IEC: 500 V / 17.5 A / 0.2 - 1.5 mm<sup>2</sup>  
 UL: 300 V / 12 A / AWG 28 - 14



For additional articles and information, refer to [catalog.weidmueller.com](http://catalog.weidmueller.com)

Note:

- Additional push button colours on request
- Operating force of slider max. 40 N
- Rated current related to rated cross-section & min. No. of poles.
- Wire end ferrule with plastic collar to DIN 46228/4
- Wire end ferrule without plastic collar to DIN 46228/1
- P on drawing = pitch
- Rated data refer only to the component itself. Clearance and creepage distances to other components are to be designed in accordance with the relevant application standards.
- Crimping shape "A" for wire end ferrules with PZ 6/5 crimping tool are recommended for the largest cable sizes.

Accessories

Note: Refer to the Accessories chapter for additional accessories.

Screwdriver		Order No.
	SDS 0.4X2.5X75	9009030000
	SDIS 0.4X2.5X75	9008370000

LSF-SMT 5.08/./90

Reflow-compatible PCB terminal



Dimensioned drawing

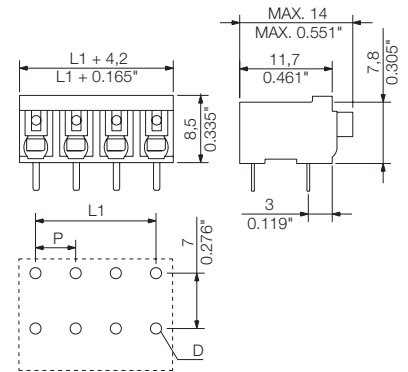

Ordering data

Solder pin length	1.5 mm		3.5 mm		
	Black		Black		
<b>Pitch</b>	<b>5.08 mm</b>				
Pol.	L1	(inch)	Qty.	Order No.	Order No.
2	5.08	0.200	59	1869670000	1824810000
3	10.16	0.400	38	1869680000	1824820000
4	15.24	0.600	28	1869690000	1824830000
5	20.32	0.800	22	1869700000	1824840000
6	25.40	1.000	18	1869710000	1824850000
7	30.48	1.200	15	1869720000	1824860000
8	35.56	1.400	13	1869730000	1824870000

Representative deratings curve

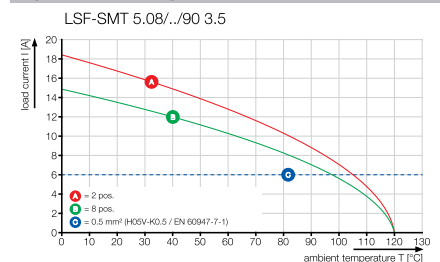

**LSF-SMT 5.08/./90 Tape**

**Reflow-compatible PCB terminal**



Dimensioned drawing

**Ordering data**

Solder pin length		1.5 mm		3.5 mm	
Colour		Black		Black	
Pitch		5.08 mm			
Pol.	L1 (inch)	Qty.	Order No.	Order No.	
2	5.08	0.200	265	1876480000	1876470000
3	10.16	0.400	265	1876440000	1876420000
4	15.24	0.600	265	1878520000	1876310000
5	20.32	0.800	265	1876210000	1876190000
6	25.40	1.000	265	1876150000	1876120000
7	30.48	1.200	265	1875720000	1875690000
8	35.56	1.400	265	1875520000	1875510000

Belt widths: 32, 44, 56, 72, 88

**Additional deratings curves**

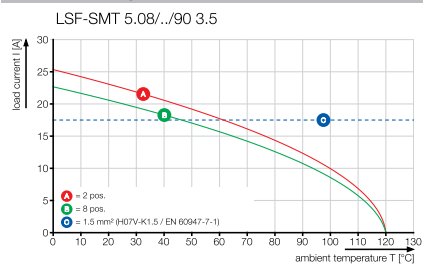

LSF-SMT 5.08/./135

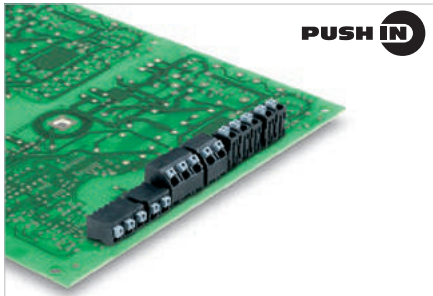

PCB terminal for fully automatic assembly in 5.08 mm pitch, for THR reflow soldering (SMT) and wave soldering.

- PUSH IN spring connection system for wire cross-sections up to 1.5 mm<sup>2</sup>.
- Form and dimensional stability through the use of LCP insulating material.
- Wire connection and slider operation from the same direction (TOP).
- Packaged in tube or tape-on-reel.
- Pin lengths optimised to 1.5 mm or 3.5 mm.
- Wire outlet direction: 135° version

Technical data

In compliance with IEC 60664-1 / IEC 61984			
Clamping range, max.	mm <sup>2</sup>	0.13...1.5	
<b>Solid core H05(07) V-U</b>	<b>mm<sup>2</sup></b>	<b>0.2...1.5</b>	
Stranded H07 V-R			
Flexible H05(07) V-K	mm <sup>2</sup>	0.2...1.5	
Flexible with ferrule	mm <sup>2</sup>	0.25...1.5	
Ferrule with plastic collar	mm <sup>2</sup>	0.25...0.75	
Stripping length	mm	8	
Screwdriver blade	mm		
According to norm			
Tightening torque range			
<b>Rated current, max.</b>	<b>A</b>	<b>17.5</b>	<b>17.5</b>
At ambient temperature		20°C	40°C
For conductor cross-section			
Overvoltage category		III	III II
Pollution severity		3	2 2
<b>Rated voltage</b>	<b>V</b>	<b>250</b>	<b>320 500</b>
Rated impulse voltage	kV	4	4 4
<b>UL / CUL (Use Group)</b>		<b>B</b>	<b>C D</b>
<b>Rated voltage</b>	<b>V</b>	<b>300</b>	<b>300</b>
<b>Rated current</b>	<b>A</b>	<b>12</b>	<b>10</b>
<b>AWG conductor</b>	<b>AWG</b>	<b>28-14</b>	
<b>CSA (Use Group)</b>		<b>B</b>	<b>C D</b>
Rated voltage	V	300	300
Rated current	A	10	10
AWG conductor	AWG	28-14	
General data			
Type of insulation material		LCP GF	
UL 94 flammability rating		V-0	
Contact base material		Copper alloy	
Material of contact surface			
Pin dimensions = d	mm	0.35 x 0.8	
Solder eyelet Ø = D	mm	1.1	
Solder eyelet Ø tolerance	mm	+ 0,1	

Product data

IEC: 500 V / 17.5 A / 0.2 - 1.5 mm<sup>2</sup>  
 UL: 300 V / 12 A / AWG 28 - 14



For additional articles and information, refer to [catalog.weidmuller.com](http://catalog.weidmuller.com)

Note:

- Additional push button colours on request
- Operating force of slider max. 40 N
- Rated current related to rated cross-section & min. No. of poles.
- Wire end ferrule with plastic collar to DIN 46228/4
- Wire end ferrule without plastic collar to DIN 46228/1
- P on drawing = pitch
- Rated data refer only to the component itself. Clearance and creepage distances to other components are to be designed in accordance with the relevant application standards.
- Crimping shape "A" for wire end ferrules with PZ 6/5 crimping tool are recommended for the largest cable sizes.

LSF-SMT 5.08/./135

Reflow-compatible PCB terminal



Dimensioned drawing

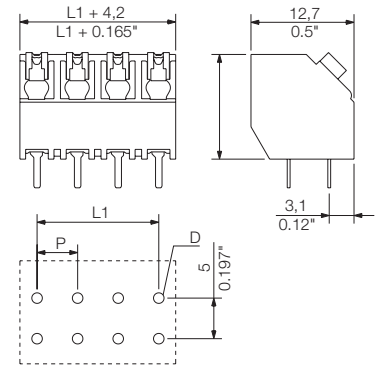

Ordering data

Solder pin length	1.5 mm		3.5 mm		
	Black		Black		
<b>Pitch</b>	<b>5.08 mm</b>				
Pol.	L1	(inch)	Qty.	Order No.	Order No.
2	5.08	0.200	59	1884730000	1885020000
3	10.16	0.400	38	1884740000	1885030000
4	15.24	0.600	28	1884750000	1885040000
5	20.32	0.800	22	1884760000	1885050000
6	25.40	1.000	18	1884770000	1885060000
7	30.48	1.200	15	1884780000	1885070000
8	35.56	1.400	13	1884790000	1885080000
9	40.64	1.600	12	1884800000	1885090000
10	45.72	1.800	11	1884810000	1885100000
11	50.80	2.000	10	1884820000	1885110000
12	55.88	2.200	9	1884830000	1885120000
13	60.96	2.400	8	1884840000	1885130000
14	66.04	2.600	7	1884850000	1885140000
15	71.12	2.800	7	1884860000	1885150000
16	76.20	3.000	6	1884870000	1885160000

Representative deratings curve

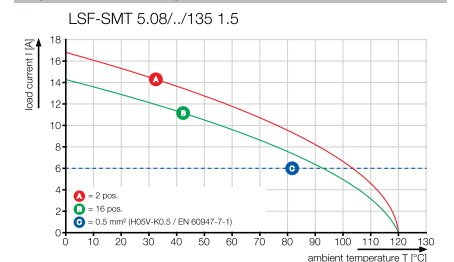

**LSF-SMT 5.08/./135 Tape**

**Reflow-compatible PCB terminal**



Dimensioned drawing

**Ordering data**

Solder pin length		1.5 mm	3.5 mm
Colour		Black	Black
Pitch		5.08 mm	
Pol.	L1 (inch)	Qty.	Order No.
2	5.08 0.200	190	1888710000 1888780000
3	10.16 0.400	190	1888720000 1888790000
4	15.24 0.600	190	1888730000 1888810000
5	20.32 0.800	190	1888740000 1888830000
6	25.40 1.000	190	1888750000 1888840000
7	30.48 1.200	190	1888760000 1888870000
8	35.56 1.400	190	1888770000 1888880000

Belt widths: 32, 44, 56, 72, 88

**Additional deratings curves**

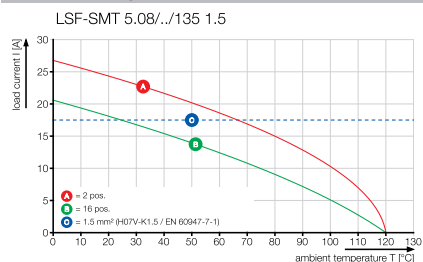

LSF-SMT 5.08/./180

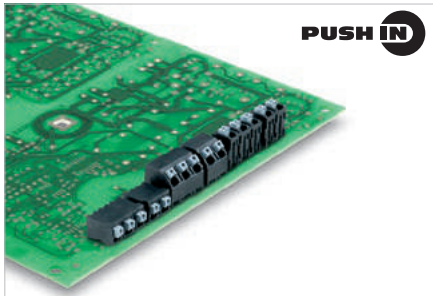

PCB terminal for fully automatic assembly in 5.08 mm pitch, for THR reflow soldering (SMT) and wave soldering.

- PUSH IN spring connection system for wire cross-sections up to 1.5 mm<sup>2</sup>.
- Form and dimensional stability through the use of LCP insulating material.
- Wire connection and slider operation from the same direction (TOP).
- Packaged in tube or tape-on-reel.
- Pin lengths optimised to 1.5 mm or 3.5 mm.
- Wire outlet direction: 180° version

Technical data

In compliance with IEC 60664-1 / IEC 61984			
Clamping range, max.	mm <sup>2</sup>	0.13...1.5	
<b>Solid core H05(07) V-U</b>	<b>mm<sup>2</sup></b>	<b>0.2...1.5</b>	
Stranded H07 V-R			
Flexible H05(07) V-K	mm <sup>2</sup>	0.2...1.5	
Flexible with ferrule	mm <sup>2</sup>	0.25...1.5	
Ferrule with plastic collar	mm <sup>2</sup>	0.25...0.75	
Stripping length	mm	8	
Screwdriver blade	mm		
According to norm			
Tightening torque range			
<b>Rated current, max.</b>	<b>A</b>	<b>17.5</b>	<b>17.5</b>
At ambient temperature		20°C	40°C
For conductor cross-section			
Overtoltage category		III	III II
Pollution severity		3	2 2
<b>Rated voltage</b>	<b>V</b>	<b>250</b>	<b>320 500</b>
Rated impulse voltage	kV	4	4 4
<b>UL / CUL (Use Group)</b>		<b>B</b>	<b>C D</b>
<b>Rated voltage</b>	<b>V</b>	<b>300</b>	<b>300</b>
<b>Rated current</b>	<b>A</b>	<b>12</b>	<b>10</b>
<b>AWG conductor</b>	<b>AWG</b>	<b>28-14</b>	
<b>CSA (Use Group)</b>		<b>B</b>	<b>C D</b>
Rated voltage	V	300	300
Rated current	A	10	10
AWG conductor	AWG	28-14	
<b>General data</b>			
Type of insulation material		LCP GF	
UL 94 flammability rating		V-0	
Contact base material		Copper alloy	
Material of contact surface			
Pin dimensions = d	mm	0.35 x 0.8	
Solder eyelet Ø = D	mm	1.1	
Solder eyelet Ø tolerance	mm	+ 0,1	

Product data

IEC: 500 V / 17.5 A / 0.2 - 1.5 mm<sup>2</sup>  
 UL: 300 V / 12 A / AWG 28 - 14



For additional articles and information, refer to [catalog.weidmueller.com](http://catalog.weidmueller.com)

Note:

- Additional push button colours on request
- Operating force of slider max. 40 N
- Rated current related to rated cross-section & min. No. of poles.
- Wire end ferrule with plastic collar to DIN 46228/4
- Wire end ferrule without plastic collar to DIN 46228/1
- P on drawing = pitch
- Rated data refer only to the component itself. Clearance and creepage distances to other components are to be designed in accordance with the relevant application standards.
- Crimping shape "A" for wire end ferrules with PZ 6/5 crimping tool are recommended for the largest cable sizes.

LSF-SMT 5.08/./180

Reflow-compatible PCB terminal



Dimensioned drawing

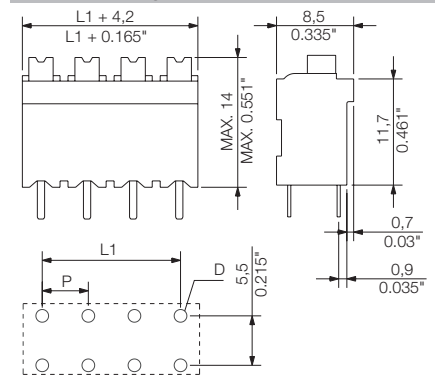

Accessories

Note: Refer to the Accessories chapter for additional accessories.

Screwdriver		Order No.
	SDS 0.4X2.5X75	9009030000
	SDIS 0.4X2.5X75	9008370000

Ordering data

Solder pin length	1.5 mm		3.5 mm		
	Black		Black		
<b>Pitch</b>	<b>5.08 mm</b>				
Pol.	L1	(inch)	Qty.	Order No.	Order No.
2	5.08	0.200	59	1870210000	1826040000
3	10.16	0.400	38	1870220000	1826060000
4	15.24	0.600	28	1870230000	1826070000
5	20.32	0.800	22	1870240000	1826080000
6	25.40	1.000	18	1870250000	1826100000
7	30.48	1.200	15	1870260000	1826110000
8	35.56	1.400	13	1870270000	1826120000

Representative deratings curve

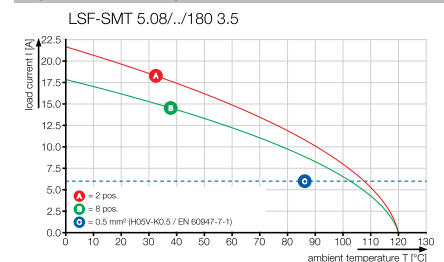

LSF-SMT 5.08/./180 Tape

Reflow-compatible PCB terminal



Dimensioned drawing

Ordering data

Solder pin length		1.5 mm		3.5 mm	
Colour		Black		Black	
Pitch		5.08 mm			
Pol.	L1 (inch)	Qty.	Order No.	Order No.	
2	5.08	0.200	175	1876500000	1876490000
3	10.16	0.400	175	1876460000	1876450000
4	15.24	0.600	175	1876410000	1876360000
5	20.32	0.800	175	1876290000	1876250000
6	25.40	1.000	175	1876180000	1876170000
7	30.48	1.200	175	1876100000	1875750000
8	35.56	1.400	175	1875610000	1875580000

Belt widths: 32, 44, 56, 72, 88

Additional deratings curves

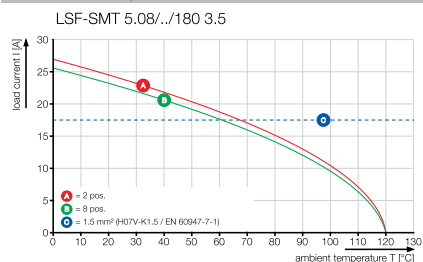

LSF-SMT 7.50/././90

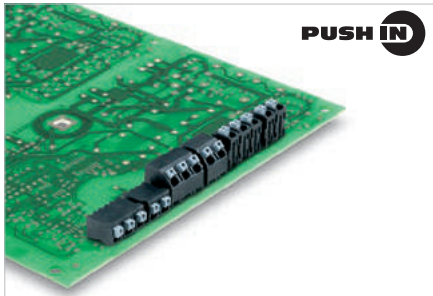

PCB terminal for fully automatic assembly in 7.50 mm pitch, for THR reflow soldering (SMT) and wave soldering.

- PUSH IN spring connection system for wire cross-sections up to 1.5 mm<sup>2</sup>.
- Form and dimensional stability through the use of LCP insulating material.
- Wire connection and slider operation from the same direction (TOP).
- Packaged in tube or tape-on-reel.
- Pin lengths optimised to 1.5 mm or 3.5 mm.
- Wire outlet direction: 90° version

Technical data

In compliance with IEC 60664-1 / IEC 61984			
Clamping range, max.	mm <sup>2</sup>	0.13...1.5	
<b>Solid core H05(07) V-U</b>	<b>mm<sup>2</sup></b>	<b>0.2...1.5</b>	
Stranded H07 V-R			
Flexible H05(07) V-K	mm <sup>2</sup>	0.2...1.5	
Flexible with ferrule	mm <sup>2</sup>	0.25...1.5	
Ferrule with plastic collar	mm <sup>2</sup>	0.25...0.75	
Stripping length	mm	8	
Screwdriver blade	mm		
According to norm			
Tightening torque range			
<b>Rated current, max.</b>	<b>A</b>	<b>17.5</b>	<b>17.5</b>
At ambient temperature		20°C	40°C
For conductor cross-section			
Overtoltage category		III	III II
Pollution severity		3	2 2
<b>Rated voltage</b>	<b>V</b>	<b>500</b>	<b>630 800</b>
Rated impulse voltage	kV	6	6 6
<b>UL / CUL (Use Group)</b>		<b>B</b>	<b>C D</b>
<b>Rated voltage</b>	<b>V</b>	<b>300</b>	<b>150 300</b>
<b>Rated current</b>	<b>A</b>	<b>12</b>	<b>10 10</b>
<b>AWG conductor</b>	<b>AWG</b>	<b>28-14</b>	
<b>CSA (Use Group)</b>		<b>B</b>	<b>C D</b>
Rated voltage	V	300	150 300
Rated current	A	10	10 10
AWG conductor	AWG	28-14	
<b>General data</b>			
Type of insulation material		LCP GF	
UL 94 flammability rating		V-0	
Contact base material		Copper alloy	
Material of contact surface			
Pin dimensions = d	mm	0.35 x 0.8	
Solder eyelet Ø = D	mm	1.1	
Solder eyelet Ø tolerance	mm	+ 0,1	

7.50

90°

1.5 mm<sup>2</sup>

Product data

IEC: 800 V / 17.5 A / 0.2 - 1.5 mm<sup>2</sup>  
 UL: 300 V / 12 A / AWG 28 - 14



For additional articles and information, refer to [catalog.weidmueller.com](http://catalog.weidmueller.com)

Note:

- Additional push button colours on request
- Operating force of slider max. 40 N
- Rated current related to rated cross-section & min. No. of poles.
- Wire end ferrule with plastic collar to DIN 46228/4
- Wire end ferrule without plastic collar to DIN 46228/1
- P on drawing = pitch
- Rated data refer only to the component itself. Clearance and creepage distances to other components are to be designed in accordance with the relevant application standards.
- Crimping shape "A" for wire end ferrules with PZ 6/5 crimping tool are recommended for the largest cable sizes.

LSF-SMT 7.50/././90

Reflow-compatible PCB terminal



Dimensioned drawing

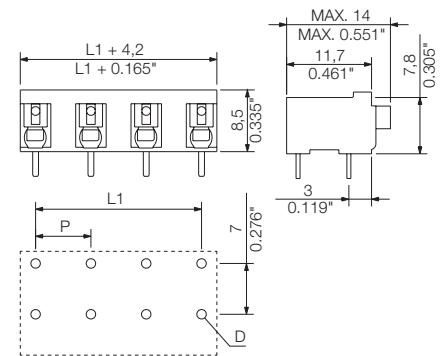

Accessories

Note: Refer to the Accessories chapter for additional accessories.

Screwdriver		Order No.
	SDS 0.4X2.5X75	9009030000
	SDIS 0.4X2.5X75	9008370000

Ordering data

Solder pin length	1.5 mm		3.5 mm		
	Black		Black		
<b>Pitch</b>	<b>7.50 mm</b>				
Pol.	L1	(inch)	Qty.	Order No.	Order No.
2	7.50	0.295	47	1869740000	1824880000
3	15.00	0.591	28	1869750000	1824890000
4	22.50	0.886	20	1869760000	1824900000
5	30.00	1.181	16	1869770000	1824910000
6	37.50	1.476	13	1869780000	1824920000
7	45.00	1.772	11	1869790000	1824930000
8	52.50	2.067	9	1869800000	1824940000

Representative deratings curve

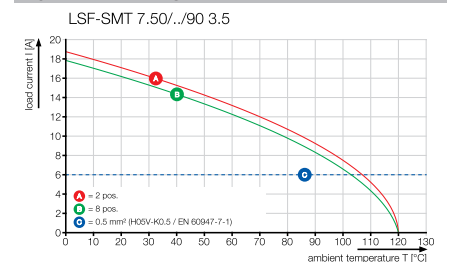



LSF-SMT 7.50/./90 Tape

Reflow-compatible PCB terminal



Dimensioned drawing

Ordering data

Solder pin length		1.5 mm	3.5 mm
Colour		Black	Black
Pitch		7.50 mm	
Pol.	L1 (inch)	Qty.	Order No.
2	7.50 0.295	265	1875480000 1875470000
3	15.00 0.591	265	1875440000 1875430000
4	22.50 0.886	265	1875040000 1875020000
5	30.00 1.181	265	1874980000 1874960000
6	37.50 1.476	265	1874910000 1874880000

Belt widths: 32, 44, 56, 72, 88

Additional deratings curves

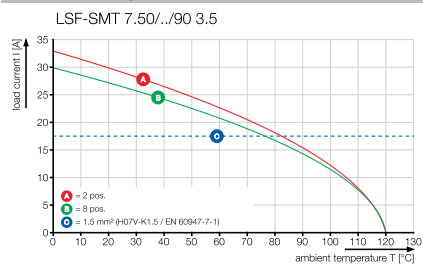

LSF-SMT 7.50/././135

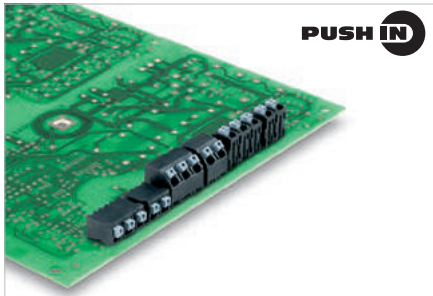

PCB terminal for fully automatic assembly in 7.50 mm pitch, for THR reflow soldering (SMT) and wave soldering.

- PUSH IN spring connection system for wire cross-sections up to 1.5 mm<sup>2</sup>.
- Form and dimensional stability through the use of LCP insulating material.
- Wire connection and slider operation from the same direction (TOP).
- Packaged in tube or tape-on-reel.
- Pin lengths optimised to 1.5 mm or 3.5 mm.
- Wire outlet direction: 135° version

Technical data

In compliance with IEC 60664-1 / IEC 61984

Clamping range, max.	mm <sup>2</sup>	0.13...1.5
<b>Solid core H05(07) V-U</b>	<b>mm<sup>2</sup></b>	<b>0.2...1.5</b>
Stranded H07 V-R		
Flexible H05(07) V-K	mm <sup>2</sup>	0.2...1.5
Flexible with ferrule	mm <sup>2</sup>	0.25...1.5
Ferrule with plastic collar	mm <sup>2</sup>	0.25...0.75
Stripping length	mm	8
Screwdriver blade	mm	
According to norm		
Tightening torque range		
<b>Rated current, max.</b>	<b>A</b>	<b>17.5 17.5</b>
At ambient temperature	20°C	40°C
For conductor cross-section		
Overtoltage category		III III II
Pollution severity		3 2 2
<b>Rated voltage</b>	<b>V</b>	<b>500 630 800</b>
Rated impulse voltage	kV	6 6 6
<b>UL / CUL (Use Group)</b>	<b>B C D</b>	
<b>Rated voltage</b>	<b>V</b>	<b>300 300</b>
<b>Rated current</b>	<b>A</b>	<b>12 10</b>
<b>AWG conductor</b>	<b>AWG</b>	<b>28-14</b>
<b>CSA (Use Group)</b>	<b>B C D</b>	
Rated voltage	V	300 300
Rated current	A	10 10
AWG conductor	AWG	28-14
<b>General data</b>		
Type of insulation material		LCP GF
UL 94 flammability rating		V-0
Contact base material		Copper alloy
Material of contact surface		
Pin dimensions = d	mm	0.35 x 0.8
Solder eyelet Ø = D	mm	1.1
Solder eyelet Ø tolerance	mm	+ 0,1

Product data

IEC: 800 V / 17.5 A / 0.2 - 1.5 mm<sup>2</sup>  
UL: 300 V / 12 A / AWG 28 - 14



For additional articles and information, refer to [catalog.weidmuller.com](http://catalog.weidmuller.com)

Note:

- Additional push button colours on request
- Operating force of slider max. 40 N
- Rated current related to rated cross-section & min. No. of poles.
- Wire end ferrule with plastic collar to DIN 46228/4
- Wire end ferrule without plastic collar to DIN 46228/1
- P on drawing = pitch
- Rated data refer only to the component itself. Clearance and creepage distances to other components are to be designed in accordance with the relevant application standards.
- Crimping shape "A" for wire end ferrules with PZ 6/5 crimping tool are recommended for the largest cable sizes.

LSF-SMT 7.50/././135

Reflow-compatible PCB terminal



Dimensioned drawing

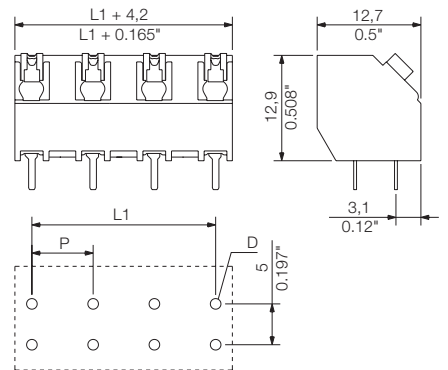

Ordering data

Solder pin length		1.5 mm	3.5 mm		
Colour		Black	Black		
Pitch 7.50 mm					
Pol.	L1	(inch)	Qty.	Order No.	Order No.
2	7.50	0.295	47	1884880000	1886110000
3	15.00	0.591	28	1884890000	1886120000
4	22.50	0.886	20	1884900000	1886130000
5	30.00	1.181	16	1884910000	1886140000
6	37.50	1.476	13	1884920000	1886150000
7	45.00	1.772	11	1884930000	1886160000
8	52.50	2.067	9	1884940000	1886170000

Accessories

Note: Refer to the Accessories chapter for additional accessories.

Screwdriver		Order No.
	SDS 0.4X2.5X75	9009030000
	SDIS 0.4X2.5X75	9008370000

Representative deratings curve

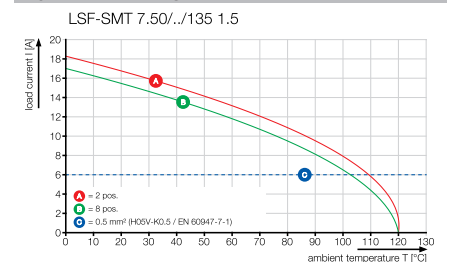

**LSF-SMT 7.50/./135 Tape**

Reflow-compatible PCB terminal



Dimensioned drawing

**Ordering data**

Solder pin length		1.5 mm	3.5 mm
Colour		Black	Black
Pitch		7.50 mm	
Pol.	L1 (inch)	Qty.	Order No.
2	7.50 0.295	190	1888890000 1888970000
3	15.00 0.591	190	1888910000 1888990000
4	22.50 0.886	190	1888930000 1889000000
5	30.00 1.181	190	1888940000 1889020000
6	37.50 1.476	190	1888950000 1889030000

Belt widths: 32, 44, 56, 72, 88

**Additional deratings curves**

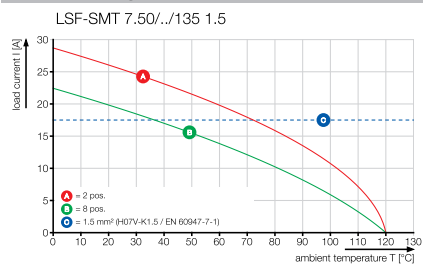

LSF-SMT 7.50/./180

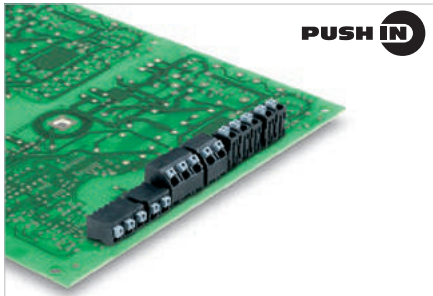

PCB terminal for fully automatic assembly in 7.50 mm pitch, for THR reflow soldering (SMT) and wave soldering.

- PUSH IN spring connection system for wire cross-sections up to 1.5 mm<sup>2</sup>.
- Form and dimensional stability through the use of LCP insulating material.
- Wire connection and slider operation from the same direction (TOP).
- Packaged in tube or tape-on-reel.
- Pin lengths optimised to 1.5 mm or 3.5 mm.
- Wire outlet direction: 180° version

Technical data

In compliance with IEC 60664-1 / IEC 61984			
Clamping range, max.	mm <sup>2</sup>	0.13...1.5	
<b>Solid core H05(07) V-U</b>	<b>mm<sup>2</sup></b>	<b>0.2...1.5</b>	
Stranded H07 V-R			
Flexible H05(07) V-K	mm <sup>2</sup>	0.2...1.5	
Flexible with ferrule	mm <sup>2</sup>	0.25...1.5	
Ferrule with plastic collar	mm <sup>2</sup>	0.25...0.75	
Stripping length	mm	8	
Screwdriver blade	mm		
According to norm			
Tightening torque range			
<b>Rated current, max.</b>	<b>A</b>	<b>17.5</b>	<b>17.5</b>
At ambient temperature		20°C	40°C
For conductor cross-section			
Overtoltage category		III	III II
Pollution severity		3	2 2
<b>Rated voltage</b>	<b>V</b>	<b>500</b>	<b>630 800</b>
Rated impulse voltage	kV	6	6 6
<b>UL / CUL (Use Group)</b>		<b>B</b>	<b>C D</b>
<b>Rated voltage</b>	<b>V</b>	<b>300</b>	<b>150 300</b>
<b>Rated current</b>	<b>A</b>	<b>12</b>	<b>10 10</b>
<b>AWG conductor</b>	<b>AWG</b>	<b>28-14</b>	
<b>CSA (Use Group)</b>		<b>B</b>	<b>C D</b>
Rated voltage	V	300	150 300
Rated current	A	10	10 10
AWG conductor	AWG	28-14	
<b>General data</b>			
Type of insulation material		LCP GF	
UL 94 flammability rating		V-0	
Contact base material		Copper alloy	
Material of contact surface			
Pin dimensions = d	mm	0.35 x 0.8	
Solder eyelet Ø = D	mm	1.1	
Solder eyelet Ø tolerance	mm	+ 0,1	

Product data

IEC: 800 V / 17.5 A / 0.2 - 1.5 mm<sup>2</sup>  
 UL: 300 V / 12 A / AWG 28 - 14



For additional articles and information, refer to [catalog.weidmueller.com](http://catalog.weidmueller.com)

Note:

- Additional push button colours on request
- Operating force of slider max. 40 N
- Rated current related to rated cross-section & min. No. of poles.
- Wire end ferrule with plastic collar to DIN 46228/4
- Wire end ferrule without plastic collar to DIN 46228/1
- P on drawing = pitch
- Rated data refer only to the component itself. Clearance and creepage distances to other components are to be designed in accordance with the relevant application standards.
- Crimping shape "A" for wire end ferrules with PZ 6/5 crimping tool are recommended for the largest cable sizes.

LSF-SMT 7.50/./180

Reflow-compatible PCB terminal



Dimensioned drawing

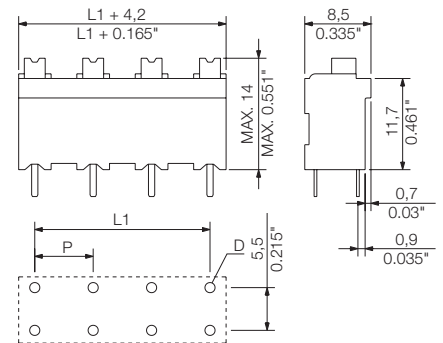

Accessories

Note: Refer to the Accessories chapter for additional accessories.

Screwdriver		Order No.
	SDS 0.4X2.5X75	9009030000
	SDIS 0.4X2.5X75	9008370000

Ordering data

Solder pin length		1.5 mm	3.5 mm	
Colour		Black	Black	
Pitch 7.50 mm				
Pol.	L1 (inch)	Qty.	Order No.	Order No.
2	7.50 0.295	47	1870280000	1826130000
3	15.00 0.591	28	1870290000	1826140000
4	22.50 0.886	20	1870300000	1826150000
5	30.00 1.181	16	1870310000	1826160000
6	37.50 1.476	13	1870320000	1826170000
7	45.00 1.772	11	1870330000	1826180000
8	52.50 2.067	9	1870340000	1826190000

Representative deratings curve

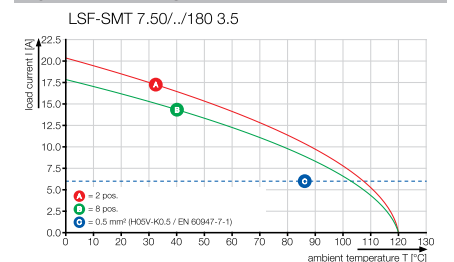

LSF-SMT 7.50/./180 Tape

Reflow-compatible PCB terminal



Dimensioned drawing

Ordering data

Solder pin length		1.5 mm	3.5 mm
Colour		Black	Black
Pitch		7.50 mm	
Pol.	L1 (inch)	Qty.	Order No.
2	7.50 0.295	175	1875500000 1875490000
3	15.00 0.591	175	1875460000 1875450000
4	22.50 0.886	175	1875090000 1875060000
5	30.00 1.181	175	1875010000 1875000000
6	37.50 1.476	175	1874950000 1874920000

Belt widths: 32, 44, 56, 72, 88

Additional deratings curves

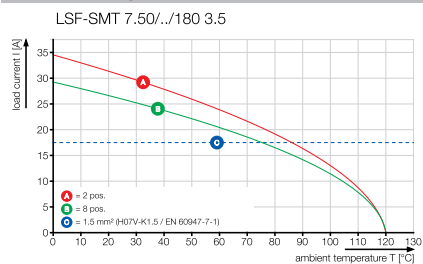

LSF-SMT 7.62/././90

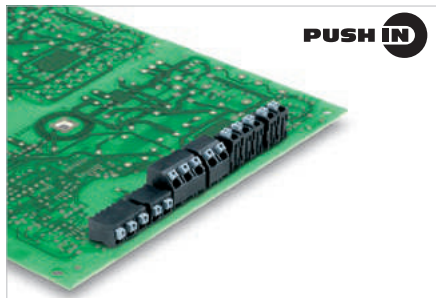

PCB terminal for fully automatic assembly in 7.62 mm pitch, for THR reflow soldering (SMT) and wave soldering.

- PUSH IN spring connection system for wire cross-sections up to 1.5 mm<sup>2</sup>.
- Form and dimensional stability through the use of LCP insulating material.
- Wire connection and slider operation from the same direction (TOP).
- Packaged in tube or tape-on-reel.
- Pin lengths optimised to 1.5 mm or 3.5 mm.
- Wire outlet direction: 90° version

Technical data

<b>In compliance with IEC 60664-1 / IEC 61984</b>			
Clamping range, max.	mm <sup>2</sup>	0.13...1.5	
<b>Solid core H05(07) V-U</b>	<b>mm<sup>2</sup></b>	<b>0.2...1.5</b>	
Stranded H07 V-R			
Flexible H05(07) V-K	mm <sup>2</sup>	0.2...1.5	
Flexible with ferrule	mm <sup>2</sup>	0.25...1.5	
Ferrule with plastic collar	mm <sup>2</sup>	0.25...0.75	
Stripping length	mm	8	
Screwdriver blade	mm		
According to norm			
Tightening torque range			
<b>Rated current, max.</b>	<b>A</b>	<b>17.5</b>	<b>17.5</b>
At ambient temperature		20°C	40°C
For conductor cross-section			
Overtoltage category		III	III II
Pollution severity		3	2 2
<b>Rated voltage</b>	<b>V</b>	<b>500</b>	<b>630 800</b>
Rated impulse voltage	kV	6	6 6
<b>UL / CUL (Use Group)</b>		<b>B</b>	<b>C D</b>
<b>Rated voltage</b>	<b>V</b>	<b>300</b>	<b>150 300</b>
<b>Rated current</b>	<b>A</b>	<b>12</b>	<b>10 10</b>
<b>AWG conductor</b>	<b>AWG</b>	<b>28-14</b>	
<b>CSA (Use Group)</b>		<b>B</b>	<b>C D</b>
Rated voltage	V	300	150 300
Rated current	A	10	10 10
AWG conductor	AWG	28-14	
<b>General data</b>			
Type of insulation material		LCP GF	
UL 94 flammability rating		V-0	
Contact base material		Copper alloy	
Material of contact surface			
Pin dimensions = d	mm	0.35 x 0.8	
Solder eyelet Ø = D	mm	1.1	
Solder eyelet Ø tolerance	mm	+ 0,1	

Product data

IEC: 800 V / 17.5 A / 0.2 - 1.5 mm<sup>2</sup>  
 UL: 300 V / 12 A / AWG 28 - 14



For additional articles and information, refer to [catalog.weidmueller.com](http://catalog.weidmueller.com)

Note:

- Additional push button colours on request
- Operating force of slider max. 40 N
- Rated current related to rated cross-section & min. No. of poles.
- Wire end ferrule with plastic collar to DIN 46228/4
- Wire end ferrule without plastic collar to DIN 46228/1
- P on drawing = pitch
- Rated data refer only to the component itself. Clearance and creepage distances to other components are to be designed in accordance with the relevant application standards.
- Crimping shape "A" for wire end ferrules with PZ 6/5 crimping tool are recommended for the largest cable sizes.

LSF-SMT 7.62/././90

Reflow-compatible PCB terminal



Dimensioned drawing

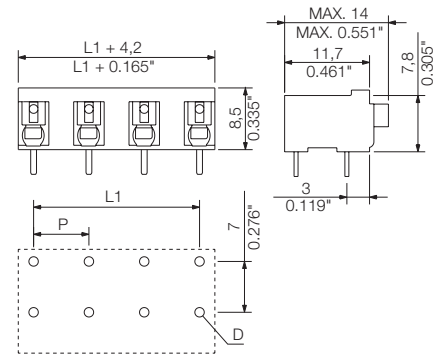

Accessories

Note: Refer to the Accessories chapter for additional accessories.

Screwdriver		Order No.
	SDS 0.4X2.5X75	9009030000
	SDIS 0.4X2.5X75	9008370000

Ordering data

Solder pin length		1.5 mm	3.5 mm		
Colour		Black	Black		
Pitch 7.62 mm					
Pol.	L1	(inch)	Qty.	Order No.	Order No.
2	7.62	0.300	46	1869260000	1824950000
3	15.24	0.600	28	1869270000	1824960000
4	22.86	0.900	20	1869280000	1824970000
5	30.48	1.200	15	1869290000	1824980000
6	38.10	1.500	13	1869300000	1824990000
7	45.72	1.800	11	1869310000	1825000000
8	53.34	2.100	9	1869320000	1825010000

Representative deratings curve

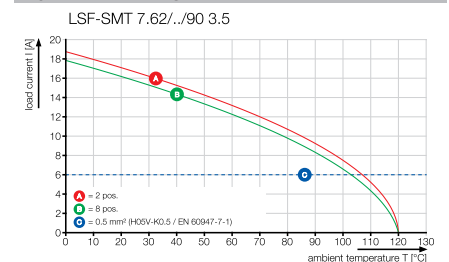

LSF-SMT 7.62/./90 Tape

Reflow-compatible PCB terminal



Dimensioned drawing

Ordering data

Solder pin length		1.5 mm	3.5 mm		
Colour		Black	Black		
Pitch		7.62 mm			
Pol.	L1 (inch)	Qty.	Order No.		
2	7.62	0.300	265	1874700000	1874670000
3	15.24	0.600	265	1874570000	1874550000
4	22.86	0.900	265	1874480000	1874470000
5	30.48	1.200	265	1874430000	1874410000
6	38.10	1.500	265	1874330000	1874290000

Belt widths: 32, 44, 56, 72, 88

Additional deratings curves

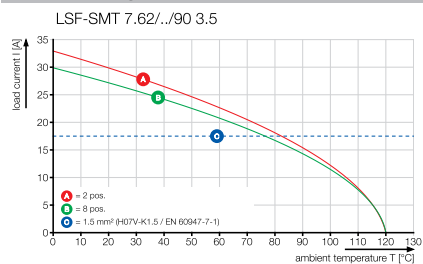

LSF-SMT 7.62/././135

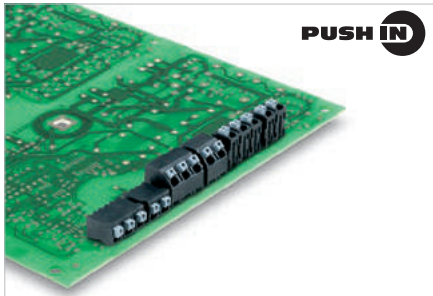

PCB terminal for fully automatic assembly in 7.62 mm pitch, for THR reflow soldering (SMT) and wave soldering.

- PUSH IN spring connection system for wire cross-sections up to 1.5 mm<sup>2</sup>.
- Form and dimensional stability through the use of LCP insulating material.
- Wire connection and slider operation from the same direction (TOP).
- Packaged in tube or tape-on-reel.
- Pin lengths optimised to 1.5 mm or 3.5 mm.
- Wire outlet direction: 135° version

Technical data

In compliance with IEC 60664-1 / IEC 61984			
Clamping range, max.	mm <sup>2</sup>	0.13...1.5	
<b>Solid core H05(07) V-U</b>	<b>mm<sup>2</sup></b>	<b>0.2...1.5</b>	
Stranded H07 V-R			
Flexible H05(07) V-K	mm <sup>2</sup>	0.2...1.5	
Flexible with ferrule	mm <sup>2</sup>	0.25...1.5	
Ferrule with plastic collar	mm <sup>2</sup>	0.25...0.75	
Stripping length	mm	8	
Screwdriver blade	mm		
According to norm			
Tightening torque range			
<b>Rated current, max.</b>	<b>A</b>	<b>17.5</b>	<b>17.5</b>
At ambient temperature		20°C	40°C
For conductor cross-section		III	III II
Overtoltage category		III	III II
Pollution severity		3	2 2
<b>Rated voltage</b>	<b>V</b>	<b>500</b>	<b>630 800</b>
Rated impulse voltage	kV	6	6 6
<b>UL / CUL (Use Group)</b>		<b>B</b>	<b>C D</b>
<b>Rated voltage</b>	<b>V</b>	<b>300</b>	<b>300</b>
<b>Rated current</b>	<b>A</b>	<b>12</b>	<b>10</b>
<b>AWG conductor</b>	<b>AWG</b>	<b>28-14</b>	
<b>CSA (Use Group)</b>		<b>B</b>	<b>C D</b>
Rated voltage	V	300	300
Rated current	A	10	10
AWG conductor	AWG	28-14	
General data			
Type of insulation material		LCP GF	
UL 94 flammability rating		V-0	
Contact base material		Copper alloy	
Material of contact surface			
Pin dimensions = d	mm	0.35 x 0.8	
Solder eyelet Ø = D	mm	1.1	
Solder eyelet Ø tolerance	mm	+ 0,1	

Product data

IEC: 800 V / 17.5 A / 0.2 - 1.5 mm<sup>2</sup>  
 UL: 300 V / 12 A / AWG 28 - 14



For additional articles and information, refer to [catalog.weidmueller.com](http://catalog.weidmueller.com)

Note:

- Additional push button colours on request
- Operating force of slider max. 40 N
- Rated current related to rated cross-section & min. No. of poles.
- Wire end ferrule with plastic collar to DIN 46228/4
- Wire end ferrule without plastic collar to DIN 46228/1
- P on drawing = pitch
- Rated data refer only to the component itself. Clearance and creepage distances to other components are to be designed in accordance with the relevant application standards.
- Crimping shape "A" for wire end ferrules with PZ 6/5 crimping tool are recommended for the largest cable sizes.

Accessories

Note: Refer to the Accessories chapter for additional accessories.

Screwdriver		Order No.
	SDS 0.4X2.5X75	9009030000
	SDIS 0.4X2.5X75	9008370000

LSF-SMT 7.62/././135

Reflow-compatible PCB terminal



Dimensioned drawing

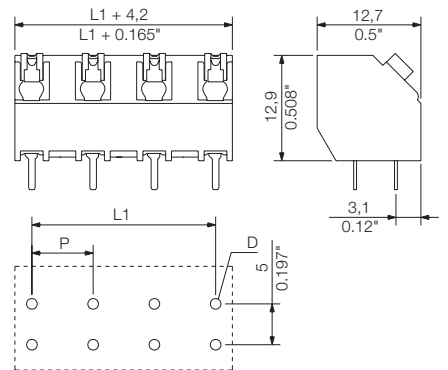

Ordering data

Solder pin length	1.5 mm		3.5 mm		
	Black		Black		
<b>Pitch</b>	<b>7.62 mm</b>				
Pol.	L1	(inch)	Qty.	Order No.	Order No.
2	7.62	0.300	46	1884950000	1886180000
3	15.24	0.600	28	1884960000	1886190000
4	22.86	0.900	20	1884970000	1886200000
5	30.48	1.200	15	1884980000	1886210000
6	38.10	1.500	13	1884990000	1886220000
7	45.72	1.800	11	1885000000	1886230000
8	53.34	2.100	9	1885010000	1886240000

Representative deratings curve

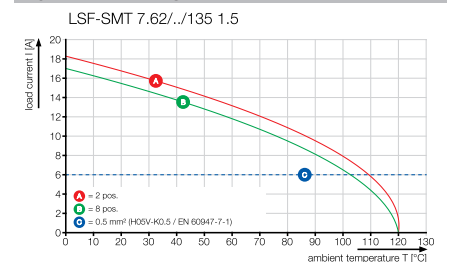



**LSF-SMT 7.62/./135 Tape**

Reflow-compatible PCB terminal



Dimensioned drawing

**Ordering data**

Solder pin length		1.5 mm	3.5 mm
Colour		Black	Black
Pitch		7.62 mm	
Pol.	L1 (inch)	Qty.	Order No.
2	7.62 0.300	190	1887110000 1887160000
3	15.24 0.600	190	1887120000 1887170000
4	22.86 0.900	190	1887130000 1887180000
5	30.48 1.200	190	1887140000 1887190000
6	38.10 1.500	190	1887150000 1887200000

Belt widths: 32, 44, 56, 72, 88

**Additional deratings curves**

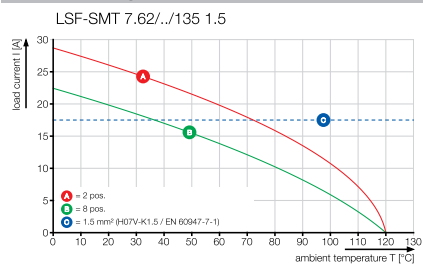

LSF-SMT 7.62/./180

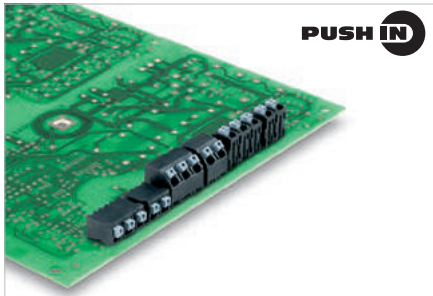

PCB terminal for fully automatic assembly in 7.62 mm pitch, for THR reflow soldering (SMT) and wave soldering.

- PUSH IN spring connection system for wire cross-sections up to 1.5 mm<sup>2</sup>.
- Form and dimensional stability through the use of LCP insulating material.
- Wire connection and slider operation from the same direction (TOP).
- Packaged in tube or tape-on-reel.
- Pin lengths optimised to 1.5 mm or 3.5 mm.
- Wire outlet direction: 180° version

Technical data

In compliance with IEC 60664-1 / IEC 61984			
Clamping range, max.	mm <sup>2</sup>	0.13...1.5	
<b>Solid core H05(07) V-U</b>	<b>mm<sup>2</sup></b>	<b>0.2...1.5</b>	
Stranded H07 V-R			
Flexible H05(07) V-K	mm <sup>2</sup>	0.2...1.5	
Flexible with ferrule	mm <sup>2</sup>	0.25...1.5	
Ferrule with plastic collar	mm <sup>2</sup>	0.25...0.75	
Stripping length	mm	8	
Screwdriver blade	mm		
According to norm			
Tightening torque range			
<b>Rated current, max.</b>	<b>A</b>	<b>17.5</b>	<b>17.5</b>
At ambient temperature		20°C	40°C
For conductor cross-section			
Overvoltage category		III	III II
Pollution severity		3	2 2
<b>Rated voltage</b>	<b>V</b>	<b>500</b>	<b>630 800</b>
Rated impulse voltage	kV	6	6 6
<b>UL / CUL (Use Group)</b>		<b>B</b>	<b>C D</b>
<b>Rated voltage</b>	<b>V</b>	<b>300</b>	<b>150 300</b>
<b>Rated current</b>	<b>A</b>	<b>12</b>	<b>10 10</b>
<b>AWG conductor</b>	<b>AWG</b>	<b>28-14</b>	
<b>CSA (Use Group)</b>		<b>B</b>	<b>C D</b>
Rated voltage	V	300	150 300
Rated current	A	10	10 10
AWG conductor	AWG	28-14	
<b>General data</b>			
Type of insulation material		LCP GF	
UL 94 flammability rating		V-0	
Contact base material		Copper alloy	
Material of contact surface			
Pin dimensions = d	mm	0.35 x 0.8	
Solder eyelet Ø = D	mm	1.1	
Solder eyelet Ø tolerance	mm	+ 0,1	

7.62

180°

1.5 mm<sup>2</sup>

Product data

IEC: 800 V / 17.5 A / 0.2 - 1.5 mm<sup>2</sup>  
 UL: 300 V / 12 A / AWG 28 - 14



For additional articles and information, refer to [catalog.weidmuller.com](http://catalog.weidmuller.com)

Note:

- Additional push button colours on request
- Operating force of slider max. 40 N
- Rated current related to rated cross-section & min. No. of poles.
- Wire end ferrule with plastic collar to DIN 46228/4
- Wire end ferrule without plastic collar to DIN 46228/1
- P on drawing = pitch
- Rated data refer only to the component itself. Clearance and creepage distances to other components are to be designed in accordance with the relevant application standards.
- Crimping shape "A" for wire end ferrules with PZ 6/5 crimping tool are recommended for the largest cable sizes.

LSF-SMT 7.62/./180

Reflow-compatible PCB terminal



Dimensioned drawing

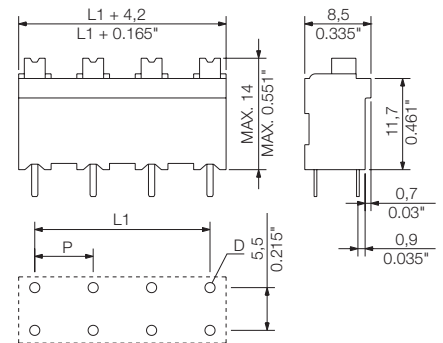

Accessories

Note: Refer to the Accessories chapter for additional accessories.

Screwdriver		Order No.
	SDS 0.4X2.5X75	9009030000
	SDIS 0.4X2.5X75	9008370000

Ordering data

Solder pin length	1.5 mm		3.5 mm	
	Black		Black	
<b>Pitch</b>	<b>7.62 mm</b>			
Pol.	L1 (inch)	Qty.	Order No.	Order No.
2	7.62 0.300	46	1869810000	1826210000
3	15.24 0.600	28	1869830000	1826220000
4	22.86 0.900	20	1869840000	1826230000
5	30.48 1.200	15	1869850000	1826240000
6	38.10 1.500	13	1869860000	1826250000
7	45.72 1.800	11	1869870000	1826260000
8	53.34 2.100	9	1869880000	1826270000

Representative deratings curve

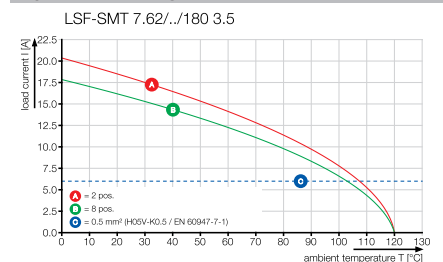

**LSF-SMT 7.62/././180 Tape**

**Reflow-compatible PCB terminal**



Dimensioned drawing

**Ordering data**

Solder pin length		1.5 mm	3.5 mm		
Colour		Black	Black		
Pitch		7.62 mm			
Pol.	L1 (inch)	Qty.	Order No.		
2	7.62	0.300	175	1874870000	1874750000
3	15.24	0.600	175	1874650000	1874630000
4	22.86	0.900	175	1874530000	1874500000
5	30.48	1.200	175	1874450000	1874460000
6	38.10	1.500	175	1874390000	1874360000

Belt widths: 32, 44, 56, 72, 88

**Additional deratings curves**

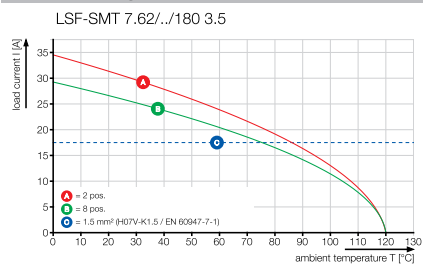

LSF-SMD 3.50

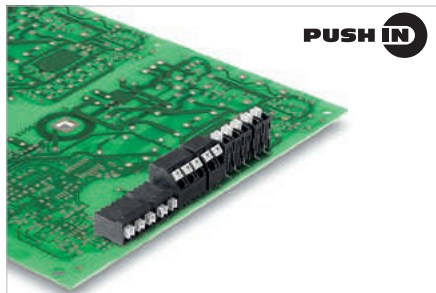

PCB terminal for fully automatic assembly using reflow soldering (SMD), with PUSH IN wire connections. Conductor insertion and slider operation from the same direction (TOP).

- Solid & flexible conductors with wire-end ferrules need only to be inserted and they are ready.
- When connecting stranded wires without wire-end ferrules the actuating element is used to open the terminal point
- Intuitive handling – since the wire-entry area and handling area are clearly separated.
- Packaged in tape-on-reel
- Conductor outlet direction 180°

Technical data

In compliance with IEC 60664-1 / IEC 61984			
Clamping range, max.	mm <sup>2</sup>	0.13...1.5	
<b>Solid core H05(07) V-U</b>	<b>mm<sup>2</sup></b>	<b>0.2...1.5</b>	
Stranded H07 V-R			
Flexible H05(07) V-K	mm <sup>2</sup>	0.2...1.5	
Flexible with ferrule	mm <sup>2</sup>	0.25...1.5	
Ferrule with plastic collar	mm <sup>2</sup>	0.25...0.75	
Stripping length	mm	8	
Screwdriver blade	mm		
According to norm			
Tightening torque range			
<b>Rated current, max.</b>	<b>A</b>	<b>17.5</b>	<b>17.5</b>
At ambient temperature	20°C		40°C
For conductor cross-section			
Overtoltage category		III	III II
Pollution severity		3	2 2
<b>Rated voltage</b>	<b>V</b>	<b>160</b>	<b>160 320</b>
Rated impulse voltage	kV	2.5	2.5 2.5
<b>UL / CUL (Use Group)</b>	<b>B C D</b>		
<b>Rated voltage</b>	<b>V</b>	<b>300</b>	<b>300</b>
<b>Rated current</b>	<b>A</b>	<b>12</b>	<b>10</b>
<b>AWG conductor</b>	<b>AWG</b>	<b>28-14</b>	
<b>CSA (Use Group)</b>	<b>B C D</b>		
Rated voltage	V	300	300
Rated current	A	10	10
AWG conductor	AWG	28-14	
<b>General data</b>			
Type of insulation material		LCP GF	
UL 94 flammability rating		V-0	
Contact base material		Copper alloy	
Material of contact surface			
Pin dimensions = d	mm		
Solder eyelet Ø = D	mm		
Solder eyelet Ø tolerance	mm		

Product data

IEC: 320 V / 17.5 A / 0.2 - 1.5 mm<sup>2</sup>  
 UL: 300 V / 12 A / AWG 28 - 14



For additional articles and information, refer to [catalog.weidmuller.com](http://catalog.weidmuller.com)

Note:

- Additional push button colours on request
- Operating force of slider max. 40 N
- Rated current related to rated cross-section & min. No. of poles.
- Wire end ferrule with plastic collar to DIN 46228/4
- Wire end ferrule without plastic collar to DIN 46228/1
- P on drawing = pitch
- Rated data refer only to the component itself. Clearance and creepage distances to other components are to be designed in accordance with the relevant application standards.
- Crimping shape "A" for wire end ferrules with PZ 6/5 crimping tool are recommended for the largest cable sizes.

LSF-SMD 3.50/.90 Tape

Reflow-compatible circuit board terminal



Dimensioned drawing

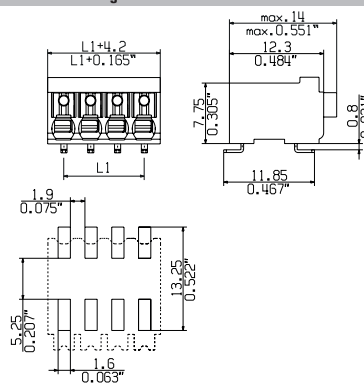

Ordering data

Solder pin length				
Colour	Black			
Pitch	3.50 mm			
Pol.	L1	(inch)	Qty.	Order No.
2	3.50	0.138	320	1412410000
3	7.00	0.276	320	1412420000
4	10.50	0.414	320	1473510000
5	14.00	0.552	320	1473520000
6	17.50	0.690	320	1473530000
7	21.00	0.828	320	1473540000
8	24.50	0.966	320	1473550000
9	28.00	1.104	320	1473570000
10	31.50	1.242	320	1473590000
11	35.00	1.380	320	1473620000
12	38.50	1.518	320	1473650000

Accessories

Note: Refer to the Accessories chapter for additional accessories.

Screwdriver		Order No.
	SDS 0.4X2.5X75	9009030000
	SDIS 0.4X2.5X75	9008370000

Representative deratings curve

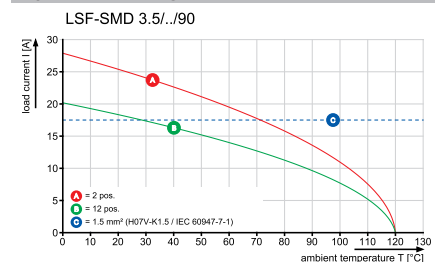

LSF-SMD 3.50../135 Tape

Reflow-compatible circuit board terminal



Dimensioned drawing

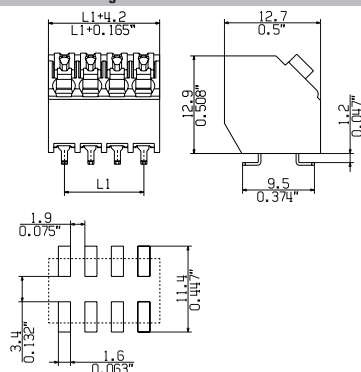

Ordering data

Solder pin length					
Colour					Black
Pitch 3.50 mm					
Pol.	L1	(inch)	Qty.	Order No.	
2	3.50	0.138	210	1473310000	
3	7.00	0.276	210	1473320000	
4	10.50	0.414	210	1473330000	
5	14.00	0.552	210	1473340000	
6	17.50	0.690	210	1473350000	
7	21.00	0.828	210	1473370000	
8	24.50	0.966	210	1473380000	
9	28.00	1.104	210	1473390000	
10	31.50	1.242	210	1473410000	
11	35.00	1.380	210	1473420000	
12	38.50	1.518	210	1473430000	

LSF-SMD 3.50/180 Tape

Reflow-compatible PCB terminal



Dimensioned drawing

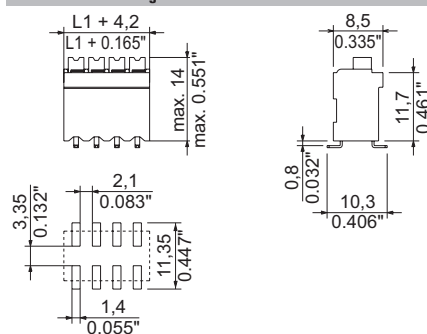

Ordering data

Solder pin length					
Colour					Black
Pitch 3.50 mm					
Pol.	L1	(inch)	Qty.	Order No.	
2	3.50	0.138	235	1250360000	
3	7.00	0.276	180	1250370000	
4	10.50	0.414	180	1250380000	
5	14.00	0.552	180	1250390000	
6	17.50	0.690	180	1250410000	
7	21.00	0.828	180	1250420000	
8	24.50	0.966	180	1250430000	
9	28.00	1.104	180	1250440000	
10	31.50	1.242	180	1250450000	
11	35.00	1.380	180	1250460000	
12	38.50	1.518	180	1250470000	

Additional deratings curves

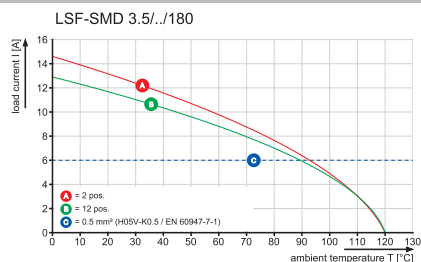
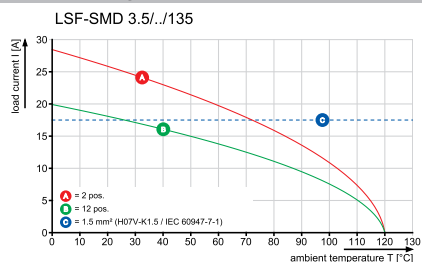

LSF-SMD 5.00

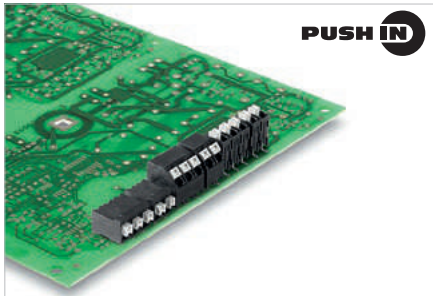

PCB terminal for fully automatic assembly using reflow soldering (SMD), with PUSH IN wire connections. Conductor insertion and slider operation from the same direction (TOP).

- Solid & flexible conductors with wire-end ferrules need only to be inserted and they are ready.
- When connecting stranded wires without wire-end ferrules the actuating element is used to open the terminal point
- Intuitive handling – since the wire-entry area and handling area are clearly separated.
- Packaged in tape-on-reel
- Conductor outlet direction 180°

Technical data

<b>In compliance with IEC 60664-1 / IEC 61984</b>			
Clamping range, max.	mm <sup>2</sup>	0.13...1.5	
<b>Solid core H05(07) V-U</b>	<b>mm<sup>2</sup></b>	<b>0.2...1.5</b>	
Stranded H07 V-R			
Flexible H05(07) V-K	mm <sup>2</sup>	0.2...1.5	
Flexible with ferrule	mm <sup>2</sup>	0.25...1.5	
Ferrule with plastic collar	mm <sup>2</sup>	0.25...0.75	
Stripping length	mm	8	
Screwdriver blade	mm		
According to norm			
Tightening torque range			
<b>Rated current, max.</b>	<b>A</b>	<b>17.5</b>	<b>17.5</b>
At ambient temperature		20°C	40°C
For conductor cross-section			
Overtoltage category		III	III II
Pollution severity		3	2 2
<b>Rated voltage</b>	<b>V</b>	<b>250</b>	<b>320 500</b>
Rated impulse voltage	kV	4	4 4
<b>UL / CUL (Use Group)</b>		<b>B</b>	<b>C D</b>
<b>Rated voltage</b>	<b>V</b>	<b>300</b>	<b>300</b>
<b>Rated current</b>	<b>A</b>	<b>12</b>	<b>10</b>
<b>AWG conductor</b>	<b>AWG</b>	<b>28-14</b>	
<b>CSA (Use Group)</b>		<b>B</b>	<b>C D</b>
Rated voltage	V	300	300
Rated current	A	10	10
AWG conductor	AWG	28-14	
<b>General data</b>			
Type of insulation material		LCP GF	
UL 94 flammability rating		V-0	
Contact base material		Copper alloy	
Material of contact surface			
Pin dimensions = d	mm		
Solder eyelet Ø = D			
Solder eyelet Ø tolerance	mm		

Product data

IEC: 500 V / 17.5 A / 0.2 - 1.5 mm<sup>2</sup>  
 UL: 300 V / 12 A / AWG 28 - 14



For additional articles and information, refer to [catalog.weidmuller.com](http://catalog.weidmuller.com)

Note:

- Additional push button colours on request
- Operating force of slider max. 40 N
- Rated current related to rated cross-section & min. No. of poles.
- Wire end ferrule with plastic collar to DIN 46228/4
- Wire end ferrule without plastic collar to DIN 46228/1
- P on drawing = pitch
- Rated data refer only to the component itself. Clearance and creepage distances to other components are to be designed in accordance with the relevant application standards.
- Crimping shape "A" for wire end ferrules with PZ 6/5 crimping tool are recommended for the largest cable sizes.

LSF-SMD 5.00/.90 Tape

Reflow-compatible circuit board terminal



Dimensioned drawing

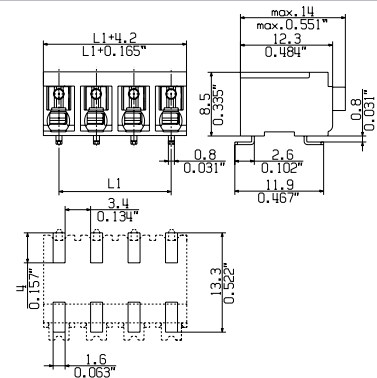

Ordering data

<b>Solder pin length</b>				
<b>Colour</b>	<b>Black</b>			
<b>Pitch</b>	<b>5.00 mm</b>			
<b>Pol.</b>	<b>L1</b>	<b>(inch)</b>	<b>Qty.</b>	<b>Order No.</b>
2	5.00	0.197	320	1473770000
3	10.00	0.394	320	1473780000
4	15.00	0.591	320	1473790000
5	20.00	0.787	320	1473800000
6	25.00	0.984	320	1473810000
7	30.00	1.181	320	1473820000
8	35.00	1.378	320	1473830000

Accessories

Note: Refer to the Accessories chapter for additional accessories.

<b>Screwdriver</b>		<b>Order No.</b>
	SDS 0.4X2.5X75	9009030000
	SDIS 0.4X2.5X75	9008370000

Representative deratings curve

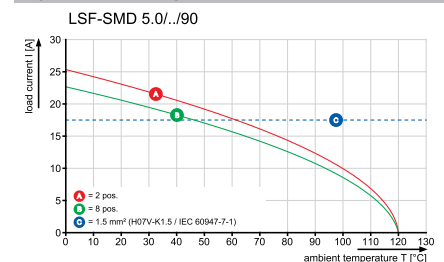

LSF-SMD 5.00../135 Tape

Reflow-compatible circuit board terminal



Dimensioned drawing

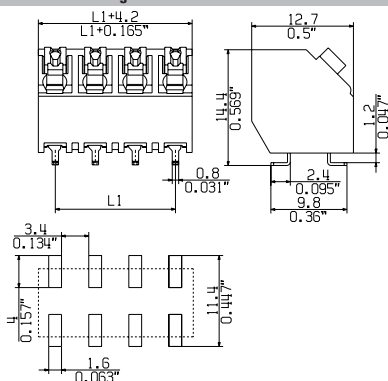

Ordering data

Solder pin length					
Colour					Black
Pitch 5.00 mm					
Pol.	L1	(inch)	Qty.	Order No.	
2	5.00	0.197	210	1473690000	
3	10.00	0.394	210	1473700000	
4	15.00	0.591	210	1473710000	
5	20.00	0.787	210	1473720000	
6	25.00	0.984	210	1473740000	
7	30.00	1.181	210	1473750000	
8	35.00	1.378	210	1473760000	

LSF-SMD 5.00../180 Tape

Reflow-compatible circuit board terminal



Dimensioned drawing

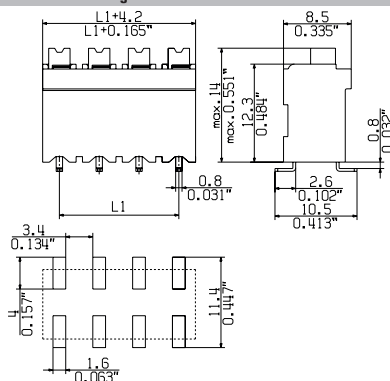

Ordering data

Solder pin length					
Colour					Black
Pitch 5.00 mm					
Pol.	L1	(inch)	Qty.	Order No.	
2	5.00	0.197	235	1473560000	
3	10.00	0.394	180	1473580000	
4	15.00	0.591	180	1473610000	
5	20.00	0.787	180	1473640000	
6	25.00	0.984	180	1473660000	
7	30.00	1.181	180	1473670000	
8	35.00	1.378	180	1473680000	

Additional deratings curves

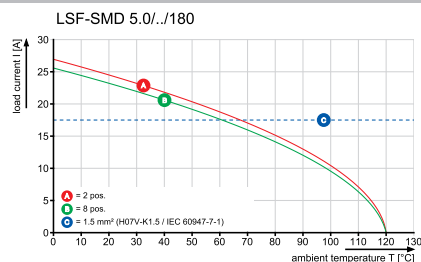
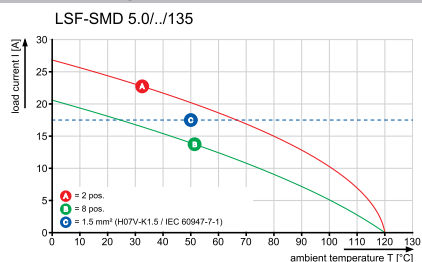

LSF-SMD 7.50

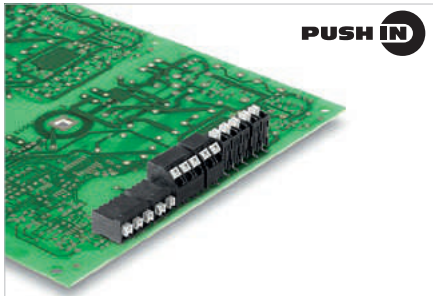

PCB terminal for fully automatic assembly using reflow soldering (SMD), with PUSH IN wire connections. Conductor insertion and slider operation from the same direction (TOP).

- Solid & flexible conductors with wire-end ferrules need only to be inserted and they are ready.
- When connecting stranded wires without wire-end ferrules the actuating element is used to open the terminal point
- Intuitive handling – since the wire-entry area and handling area are clearly separated.
- Packaged in tape-on-reel
- Conductor outlet direction 180°

Technical data

<b>In compliance with IEC 60664-1 / IEC 61984</b>			
Clamping range, max.	mm <sup>2</sup>	0.13...1.5	
<b>Solid core H05(07) V-U</b>	<b>mm<sup>2</sup></b>	<b>0.2...1.5</b>	
Stranded H07 V-R			
Flexible H05(07) V-K	mm <sup>2</sup>	0.2...1.5	
Flexible with ferrule	mm <sup>2</sup>	0.25...1.5	
Ferrule with plastic collar	mm <sup>2</sup>	0.25...0.75	
Stripping length	mm	8	
Screwdriver blade	mm		
According to norm			
Tightening torque range			
<b>Rated current, max.</b>	<b>A</b>	<b>17.5</b>	<b>17.5</b>
At ambient temperature		20°C	40°C
For conductor cross-section			
Overtoltage category		III	III II
Pollution severity		3	2 2
<b>Rated voltage</b>	<b>V</b>	<b>500</b>	<b>630 800</b>
Rated impulse voltage	kV	6	6 6
<b>UL / CUL (Use Group)</b>	<b>B C D</b>		
<b>Rated voltage</b>	<b>V</b>	<b>300</b>	<b>150 300</b>
<b>Rated current</b>	<b>A</b>	<b>12</b>	<b>10 10</b>
<b>AWG conductor</b>	<b>AWG</b>	<b>28-14</b>	
<b>CSA (Use Group)</b>	<b>B C D</b>		
Rated voltage	V	300	150 300
Rated current	A	10	10 10
AWG conductor	AWG	28-14	
<b>General data</b>			
Type of insulation material		LCP GF	
UL 94 flammability rating		V-0	
Contact base material		Copper alloy	
Material of contact surface			
Pin dimensions = d	mm		
Solder eyelet Ø = D			
Solder eyelet Ø tolerance	mm		

Product data

IEC: 800 V / 17.5 A / 0.2 - 1.5 mm<sup>2</sup>  
 UL: 300 V / 12 A / AWG 28 - 14



For additional articles and information, refer to [catalog.weidmuller.com](http://catalog.weidmuller.com)

Note:

- Additional push button colours on request
- Operating force of slider max. 40 N
- Rated current related to rated cross-section & min. No. of poles.
- Wire end ferrule with plastic collar to DIN 46228/4
- Wire end ferrule without plastic collar to DIN 46228/1
- P on drawing = pitch
- Rated data refer only to the component itself. Clearance and creepage distances to other components are to be designed in accordance with the relevant application standards.
- Crimping shape "A" for wire end ferrules with PZ 6/5 crimping tool are recommended for the largest cable sizes.

LSF-SMD 7.50/./90 Tape

Reflow-compatible circuit board terminal



Dimensioned drawing

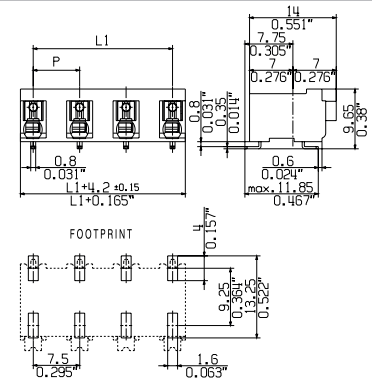

Ordering data

<b>Solder pin length</b>				
<b>Colour</b>	<b>Black</b>			
<b>Pitch</b>	<b>7.50 mm</b>			
<b>Pol.</b>	<b>L1</b>	<b>(inch)</b>	<b>Qty.</b>	<b>Order No.</b>
2	7.50	0.295	320	1473940000
3	15.00	0.590	320	1473950000
4	22.50	0.885	320	1473960000
5	30.00	1.180	320	1473970000
6	37.50	1.475	320	1473980000

Accessories

Note: Refer to the Accessories chapter for additional accessories.

<b>Screwdriver</b>		<b>Order No.</b>
	SDS 0.4X2.5X75	9009030000
	SDIS 0.4X2.5X75	9008370000

Representative deratings curve

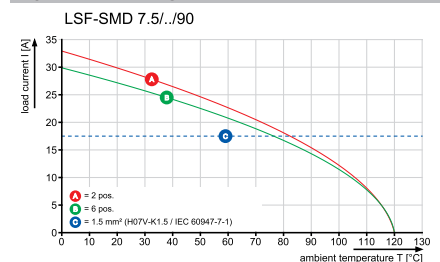



LSF-SMD 7.50../135 Tape

Reflow-compatible circuit board terminal



Dimensioned drawing

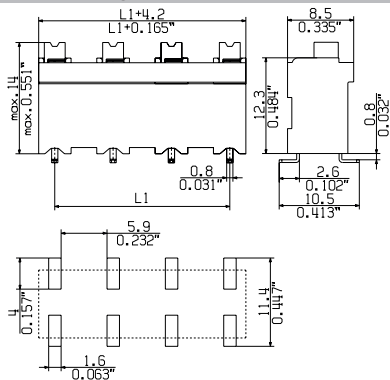

Ordering data

Solder pin length					
Colour					Black
Pitch 7.50 mm					
Pol.	L1	(inch)	Qty.	Order No.	
2	7.50	0.295	210	1473890000	
3	15.00	0.590	210	1473900000	
4	22.50	0.885	210	1473910000	
5	30.00	1.180	210	1473920000	
6	37.50	1.475	210	1473930000	

LSF-SMD 7.50../180 Tape

Reflow-compatible circuit board terminal



Dimensioned drawing

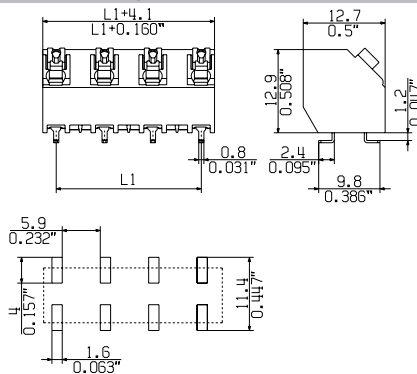

Ordering data

Solder pin length					
Colour					Black
Pitch 7.50 mm					
Pol.	L1	(inch)	Qty.	Order No.	
2	7.50	0.295	180	1473840000	
3	15.00	0.590	180	1473850000	
4	22.50	0.885	180	1473860000	
5	30.00	1.180	180	1473870000	
6	37.50	1.475	180	1473880000	

Additional deratings curves

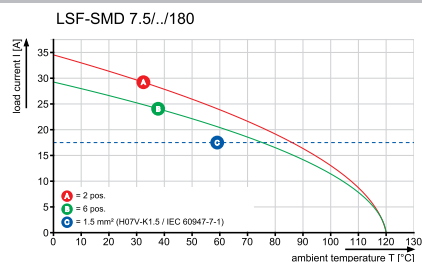
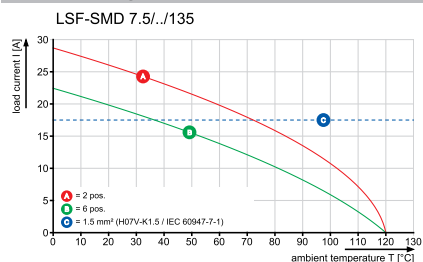

LMF & LMFS

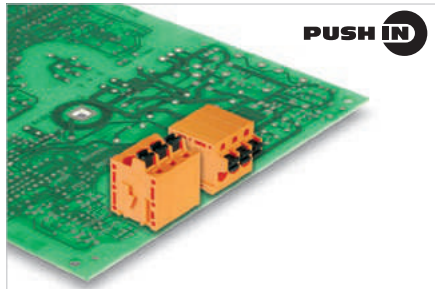

**PUSH IN**

With the new LMF, we are meeting current market requirements for a PCB terminal with a PUSH IN connection system for wire cross-sections up to 2.5 mm<sup>2</sup>.

- PUSH IN connection system
- Pusher for opening the contact point
- Integrated test point
- 90° or 180° wire outlet direction

Technical data

In compliance with IEC 60664-1 / IEC 61984

Clamping range, max.	mm <sup>2</sup>	0.12...2.5
<b>Solid core H05(07) V-U</b>	<b>mm<sup>2</sup></b>	<b>0.2...2.5</b>
Stranded H07 V-R		
Flexible H05(07) V-K	mm <sup>2</sup>	0.2...2.5
Flexible with ferrule	mm <sup>2</sup>	0.25...2.5
Ferrule with plastic collar	mm <sup>2</sup>	0.25...2.5
Stripping length	mm	10
Screwdriver blade	mm	0.6 x 3.5
According to norm		DIN 5264

Tightening torque range		
<b>Rated current, max.</b>	<b>A</b>	<b>24</b>
At ambient temperature	20°C	40°C

For conductor cross-section		
Overtoltage category	III	III
Pollution severity	3	2

<b>Rated voltage</b>	<b>V</b>	<b>250</b>	<b>320</b>	<b>400</b>
Rated impulse voltage	kV	4	4	4

<b>UL / CUL (Use Group)</b>	<b>B</b>	<b>C</b>	<b>D</b>
<b>Rated voltage</b>	<b>V</b>	<b>300</b>	<b>300</b>
<b>Rated current</b>	<b>A</b>	<b>20</b>	<b>10</b>

<b>CSA (Use Group)</b>	<b>B</b>	<b>C</b>	<b>D</b>
Rated voltage	V	300	300
Rated current	A	20	10

<b>General data</b>		
Type of insulation material		Wemid (PA)
UL 94 flammability rating		V-0

Contact base material		CuSn
Material of contact surface		tinned
Pin dimensions = d	mm	0.8

Solder eyelet Ø = D	mm	1.1
Solder eyelet Ø tolerance	mm	+ 0,1

Product data

IEC: 400 V / 24 A / 0.2 - 2.5 mm<sup>2</sup>  
 UL: 300 V / 20 A / AWG 24 - 12



For additional articles and information, refer to [catalog.weidmueller.com](http://catalog.weidmueller.com)

Note:

- Additional colours on request
- Rated current related to rated cross-section & min. No. of poles.
- Wire end ferrule without plastic collar to DIN 46228/1
- Wire end ferrule with plastic collar to DIN 46228/4
- P on drawing = pitch
- Rated data refer only to the component itself. Clearance and creepage distances to other components are to be designed in accordance with the relevant application standards.
- The test point can only be used as potential-pickup point.

LMF 5.00/./90



Dimensioned drawing

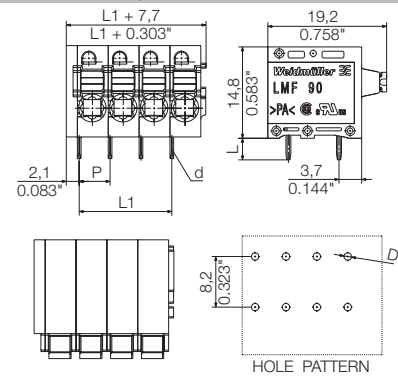

Accessories

Note: Refer to the Accessories chapter for additional accessories.

Test plug		Order No.
	PS 2.0 MC	0310000000
Screwdriver		
	SDS 0.6X3.5X100	9008330000

Ordering data

Solder pin length		3.5 mm		
Colour		Orange		
Pitch		5.00 mm		
Pol.	L1	(inch)	Qty.	Order No.
2	5.00	0.197	130	1331700000
3	10.00	0.394	90	1331710000
4	15.00	0.591	70	1331720000
5	20.00	0.787	55	1331730000
6	25.00	0.984	45	1331740000
7	30.00	1.181	40	1331750000
8	35.00	1.378	35	1331770000
9	40.00	1.575	30	1331780000
10	45.00	1.772	25	1331790000
11	50.00	1.969	25	1331800000
12	55.00	2.166	25	1331810000
13	60.00	2.362	20	1331820000
14	65.00	2.559	20	1331830000
15	70.00	2.756	20	1331840000
16	75.00	2.953	15	1331850000
17	80.00	3.150	15	1331870000
18	85.00	3.347	15	1331880000
19	90.00	3.544	15	1331890000
20	95.00	3.741	15	1331910000
21	100.00	3.937	10	1331920000
22	105.00	4.134	10	1331930000
23	110.00	4.331	10	1331940000
24	115.00	4.528	10	1331950000

Representative deratings curve

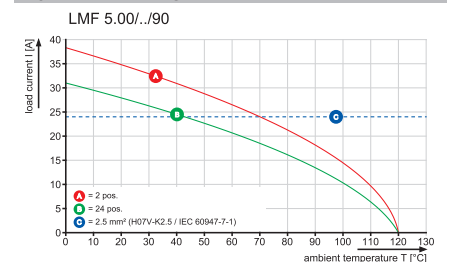

LMF 5.00/./180



Dimensioned drawing

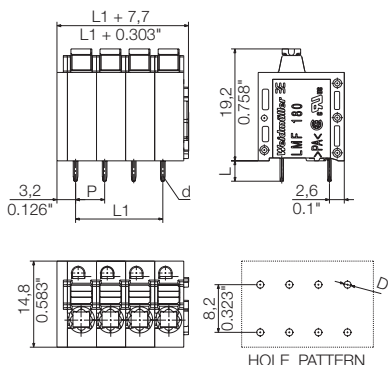

Ordering data

Solder pin length		3.5 mm	
Colour		Orange	
Pitch		5.00 mm	
Pol.	L1	(inch)	Qty. Order No.
2	5.00	0.197	130 1330180000
3	10.00	0.394	90 1330190000
4	15.00	0.591	70 1330200000
5	20.00	0.787	55 1330210000
6	25.00	0.984	45 1330220000
7	30.00	1.181	40 1330230000
8	35.00	1.378	35 1330240000
9	40.00	1.575	30 1330250000
10	45.00	1.772	30 1330270000
11	50.00	1.969	25 1330280000
12	55.00	2.166	25 1330290000
13	60.00	2.362	20 1330300000
14	65.00	2.559	20 1330310000
15	70.00	2.756	20 1330320000
16	75.00	2.953	15 1330330000
17	80.00	3.150	15 1330340000
18	85.00	3.347	15 1330350000
19	90.00	3.544	15 1330370000
20	95.00	3.741	15 1330380000
21	100.00	3.937	10 1330390000
22	105.00	4.134	10 1330400000
23	110.00	4.331	10 1330410000
24	115.00	4.528	10 1330420000

LMFS 5.00/./90



Dimensioned drawing

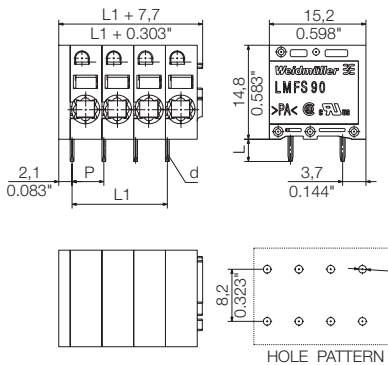

Ordering data

Solder pin length		3.5 mm	
Colour		Orange	
Pitch		5.00 mm	
Pol.	L1	(inch)	Qty. Order No.
2	5.00	0.197	130 1331960000
3	10.00	0.394	90 1331970000
4	15.00	0.591	70 1331980000
5	20.00	0.787	55 1331990000
6	25.00	0.984	45 1332010000
7	30.00	1.181	40 1332020000
8	35.00	1.378	35 1332030000
9	40.00	1.575	30 1332040000
10	45.00	1.772	25 1332050000
11	50.00	1.969	25 1332060000
12	55.00	2.166	25 1332070000
13	60.00	2.362	20 1332080000
14	65.00	2.559	20 1332090000
15	70.00	2.756	20 1332110000
16	75.00	2.953	15 1332120000
17	80.00	3.150	15 1332130000
18	85.00	3.347	15 1332140000
19	90.00	3.544	15 1332150000
20	95.00	3.741	15 1332160000
21	100.00	3.937	10 1332170000
22	105.00	4.134	10 1332180000
23	110.00	4.331	10 1332190000
24	115.00	4.528	10 1332200000

LMFS 5.00/./180



Dimensioned drawing

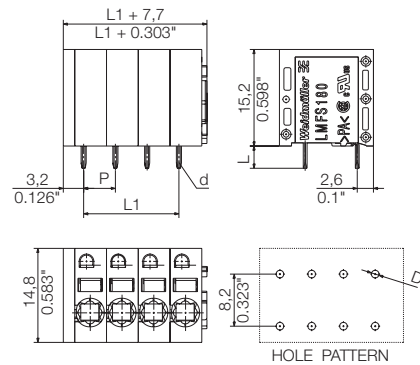

Ordering data

Solder pin length		3.5 mm	
Colour		Orange	
Pitch		5.00 mm	
Pol.	L1	(inch)	Qty. Order No.
2	5.00	0.197	130 1330430000
3	10.00	0.394	90 1330440000
4	15.00	0.591	70 1330450000
5	20.00	0.787	55 1330470000
6	25.00	0.984	45 1330490000
7	30.00	1.181	40 1330500000
8	35.00	1.378	35 1330510000
9	40.00	1.575	30 1330520000
10	45.00	1.772	30 1330530000
11	50.00	1.969	25 1330540000
12	55.00	2.166	25 1330550000
13	60.00	2.362	20 1330570000
14	65.00	2.559	20 1330580000
15	70.00	2.756	20 1330590000
16	75.00	2.953	15 1330610000
17	80.00	3.150	15 1330620000
18	85.00	3.347	15 1330630000
19	90.00	3.544	15 1330640000
20	95.00	3.741	15 1330650000
21	100.00	3.937	10 1330670000
22	105.00	4.134	10 1330680000
23	110.00	4.331	10 1330690000
24	115.00	4.528	10 1330700000

Additional deratings curves

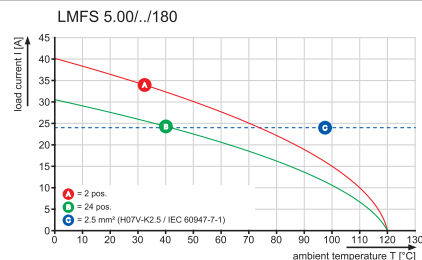
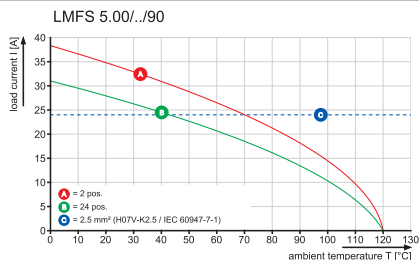
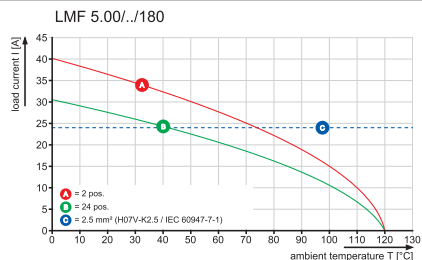

LMF & LMFS

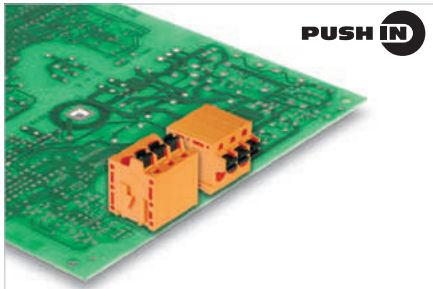

**PUSH IN**

With the new LMF, we are meeting current market requirements for a PCB terminal with a PUSH IN connection system for wire cross-sections up to 2.5 mm<sup>2</sup>.

- PUSH IN connection system
- Pusher for opening the contact point
- Integrated test point
- 90° or 180° wire outlet direction

Product data

IEC: 400 V / 24 A / 0.2 - 2.5 mm<sup>2</sup>  
UL: 300 V / 20 A / AWG 24 - 12



For additional articles and information, refer to [catalog.weidmueller.com](http://catalog.weidmueller.com)

Note:

- Additional colours on request
- Rated current related to rated cross-section & min. No. of poles.
- Wire end ferrule without plastic collar to DIN 46228/1
- Wire end ferrule with plastic collar to DIN 46228/4
- P on drawing = pitch
- Rated data refer only to the component itself. Clearance and creepage distances to other components are to be designed in accordance with the relevant application standards.
- The test point can only be used as potential-pickup point.

LMF 5.08/./90



Dimensioned drawing

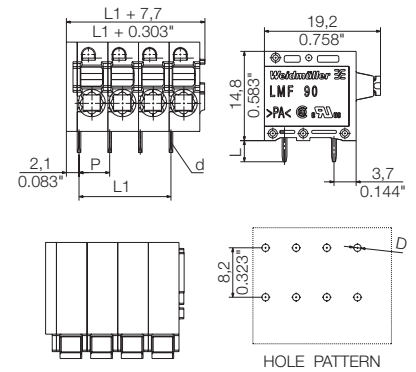

Ordering data

Solder pin length		3.5 mm		
Colour		Orange		
Pitch		5.08 mm		
Pol.	L1	(inch)	Qty.	Order No.
2	5.08	0.200	125	1330710000
3	10.16	0.400	90	1330720000
4	15.24	0.600	70	1330730000
5	20.32	0.800	55	1330740000
6	25.40	1.000	45	1330750000
7	30.48	1.200	40	1330770000
8	35.56	1.400	35	1330780000
9	40.64	1.600	30	1330790000
10	45.72	1.800	25	1330800000
11	50.80	2.000	25	1330810000
12	55.88	2.200	20	1330820000
13	60.96	2.400	20	1330830000
14	66.04	2.600	20	1330840000
15	71.12	2.800	15	1330850000
16	76.20	3.000	15	1330870000
17	81.28	3.200	15	1330880000
18	86.36	3.400	15	1330890000
19	91.44	3.600	15	1330900000
20	96.52	3.800	15	1330910000
21	101.60	4.000	10	1330920000
22	106.68	4.200	10	1330930000
23	111.76	4.400	10	1330940000
24	116.84	4.600	10	1330950000

Representative deratings curve

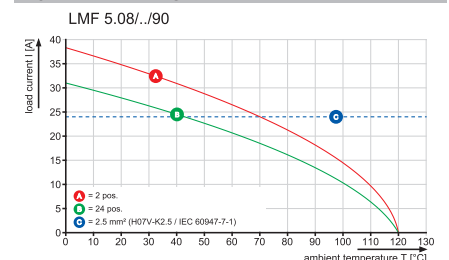

Technical data

In compliance with IEC 60664-1 / IEC 61984			
Clamping range, max.	mm <sup>2</sup>	0.12...2.5	
<b>Solid core H05(07) V-U</b>	mm <sup>2</sup>	<b>0.2...2.5</b>	
Stranded H07 V-R			
Flexible H05(07) V-K	mm <sup>2</sup>	0.2...2.5	
Flexible with ferrule	mm <sup>2</sup>	0.25...2.5	
Ferrule with plastic collar	mm <sup>2</sup>	0.25...2.5	
Stripping length	mm	10	
Screwdriver blade	mm	0.6 x 3.5	
According to norm		DIN 5264	
Tightening torque range			
<b>Rated current, max.</b>	<b>A</b>	<b>24</b>	<b>24</b>
At ambient temperature		20°C	40°C
For conductor cross-section			
Overtoltage category		III	III II
Pollution severity		3	2 2
<b>Rated voltage</b>	<b>V</b>	<b>250</b>	<b>320 400</b>
Rated impulse voltage	kV	4	4 4
<b>UL / CUL (Use Group)</b>	<b>B C D</b>	<b>C</b>	<b>D</b>
<b>Rated voltage</b>	<b>V</b>	<b>300</b>	<b>300</b>
<b>Rated current</b>	<b>A</b>	<b>20</b>	<b>10</b>
<b>AWG conductor</b>	<b>AWG</b>	<b>24-12</b>	
<b>CSA (Use Group)</b>	<b>B C D</b>	<b>C</b>	<b>D</b>
Rated voltage	V	300	300
Rated current	A	20	10
AWG conductor	AWG	24-12	
<b>General data</b>			
Type of insulation material		Wemid (PA)	
UL 94 flammability rating		V-0	
Contact base material		CuSn	
Material of contact surface		tinned	
Pin dimensions = d	mm	0.8	
Solder eyelet Ø = D	mm	1.1	
Solder eyelet Ø tolerance	mm	+ 0,1	

Accessories

Note: Refer to the Accessories chapter for additional accessories.		
Test plug		Order No.
	PS 2.0 MC	0310000000
<b>Screwdriver</b>		
	SDS 0.6X3.5X100	9008330000

LMF 5.08/./180



Dimensioned drawing

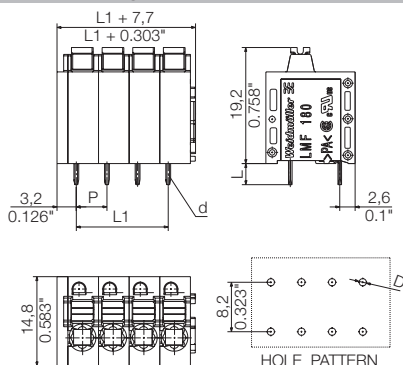

Ordering data

Solder pin length		3.5 mm	
Colour		Orange	
Pitch		5.08 mm	
Pol.	L1	(inch)	Qty. Order No.
2	5.08	0.200	130 1331080000
3	10.16	0.400	90 1331100000
4	15.24	0.600	70 1331120000
5	20.32	0.800	55 1331140000
6	25.40	1.000	45 1331160000
7	30.48	1.200	40 1331180000
8	35.56	1.400	35 1331200000
9	40.64	1.600	30 1331220000
10	45.72	1.800	25 1331240000
11	50.80	2.000	25 1331260000
12	55.88	2.200	20 1331280000
13	60.96	2.400	20 1331300000
14	66.04	2.600	20 1331310000
15	71.12	2.800	15 1331320000
16	76.20	3.000	15 1331330000
17	81.28	3.200	15 1331340000
18	86.36	3.400	15 1331350000
19	91.44	3.600	15 1331370000
20	96.52	3.800	15 1331380000
21	101.60	4.000	10 1331390000
22	106.68	4.200	10 1331400000
23	111.76	4.400	10 1331410000
24	116.84	4.600	10 1331420000

LMFS 5.08/./90



Dimensioned drawing

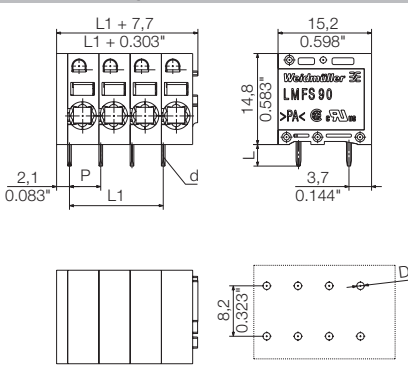

Ordering data

Solder pin length		3.5 mm	
Colour		Orange	
Pitch		5.08 mm	
Pol.	L1	(inch)	Qty. Order No.
2	5.08	0.200	130 1330960000
3	10.16	0.400	90 1330970000
4	15.24	0.600	70 1330980000
5	20.32	0.800	55 1330990000
6	25.40	1.000	45 1331000000
7	30.48	1.200	40 1331010000
8	35.56	1.400	35 1331020000
9	40.64	1.600	30 1331030000
10	45.72	1.800	25 1331040000
11	50.80	2.000	25 1331050000
12	55.88	2.200	20 1331060000
13	60.96	2.400	20 1331070000
14	66.04	2.600	20 1331090000
15	71.12	2.800	15 1331110000
16	76.20	3.000	15 1331130000
17	81.28	3.200	15 1331150000
18	86.36	3.400	15 1331170000
19	91.44	3.600	15 1331190000
20	96.52	3.800	15 1331210000
21	101.60	4.000	10 1331230000
22	106.68	4.200	10 1331250000
23	111.76	4.400	10 1331270000
24	116.84	4.600	10 1331290000

LMFS 5.08/./180



Dimensioned drawing

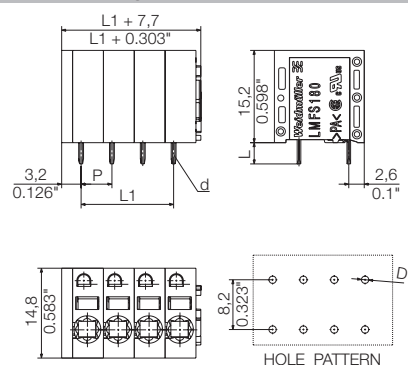

Ordering data

Solder pin length		3.5 mm	
Colour		Orange	
Pitch		5.08 mm	
Pol.	L1	(inch)	Qty. Order No.
2	5.08	0.200	130 1331430000
3	10.16	0.400	90 1331440000
4	15.24	0.600	70 1331450000
5	20.32	0.800	55 1331470000
6	25.40	1.000	45 1331480000
7	30.48	1.200	40 1331490000
8	35.56	1.400	35 1331500000
9	40.64	1.600	30 1331510000
10	45.72	1.800	25 1331520000
11	50.80	2.000	25 1331530000
12	55.88	2.200	20 1331540000
13	60.96	2.400	20 1331550000
14	66.04	2.600	20 1331570000
15	71.12	2.800	15 1331580000
16	76.20	3.000	15 1331590000
17	81.28	3.200	15 1331610000
18	86.36	3.400	15 1331620000
19	91.44	3.600	15 1331630000
20	96.52	3.800	15 1331640000
21	101.60	4.000	10 1331650000
22	106.68	4.200	10 1331670000
23	111.76	4.400	10 1331680000
24	116.84	4.600	10 1331690000

Additional deratings curves

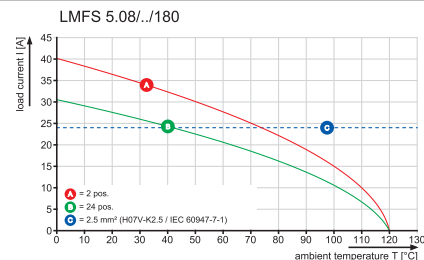
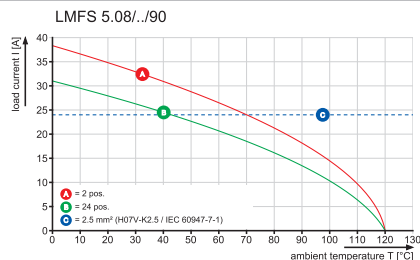
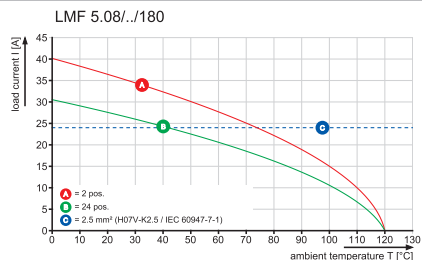

LS2HF/90

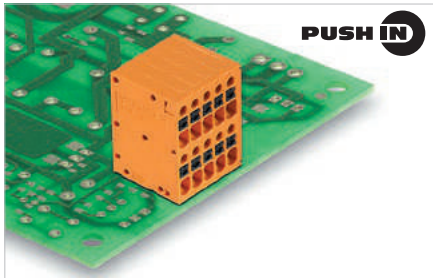

**PUSH IN**

Double-level PCB terminal for wave soldering, with PUSH IN wire connection system. Wire connection and slider operation from the same direction (TOP).

- Solid and stranded wires with wire-end ferrules need only to be inserted and they are ready
- When connecting stranded wires without wire-end ferrules, the actuating element is used to open the contact point
- Intuitive handling thanks to the clear distinction between conductor entry and actuating element
- Packaged in box
- Wire outlet direction: 90° version

Technical data

In compliance with IEC 60664-1 / IEC 61984

Clamping range, max.	mm <sup>2</sup>	0.2...1.5
<b>Solid core H05(07) V-U</b>	<b>mm<sup>2</sup></b>	<b>0.2...1.5</b>
Stranded H07 V-R		
Flexible H05(07) V-K	mm <sup>2</sup>	0.2...1.5
Flexible with ferrule	mm <sup>2</sup>	0.2...1.5
Ferrule with plastic collar	mm <sup>2</sup>	0.2...0.75
Stripping length	mm	8
Screwdriver blade	mm	0.4 x 2.5

According to norm

Tightening torque range			
<b>Rated current, max.</b>	<b>A</b>	<b>17.5</b>	<b>17.5</b>
At ambient temperature		20°C	40°C

For conductor cross-section			
Overtoltage category		III	III
Pollution severity		3	2
		2	2

<b>Rated voltage</b>	<b>V</b>	<b>160</b>	<b>200</b>	<b>400</b>
Rated impulse voltage	kV	2.5	2.5	2.5

**UL / CUL (Use Group)**

		<b>B</b>	<b>C</b>	<b>D</b>
<b>Rated voltage</b>	<b>V</b>	<b>150</b>		<b>150</b>
<b>Rated current</b>	<b>A</b>	<b>12.5</b>		<b>12.5</b>

**AWG conductor**

	<b>AWG</b>	<b>26-16</b>	
<b>CSA (Use Group)</b>	<b>B</b>	<b>C</b>	<b>D</b>
Rated voltage	V	150	150
Rated current	A	12.5	12.5
AWG conductor	AWG	26-16	

General data

Type of insulation material		PA 66/6
UL 94 flammability rating		V-0
Contact base material		Copper alloy
Material of contact surface		
Pin dimensions = d	mm	1.0 x 0.6
Solder eyelet Ø = D	mm	1.3
Solder eyelet Ø tolerance	mm	+ 0,1

Product data

IEC: 400 V / 17.5 A / 0.2 - 1.5 mm<sup>2</sup>  
 UL: 150 V / 12.5 A / AWG 26 - 16



For additional articles and information, refer to [catalog.weidmuller.com](http://catalog.weidmuller.com)

Note:

- Additional colours on request
- Rated current related to rated cross-section & min. No. of poles.
- Wire end ferrule without plastic collar to DIN 46228/1
- Wire end ferrule with plastic collar to DIN 46228/4
- P on drawing = pitch
- Rated data refer only to the component itself. Clearance and creepage distances to other components are to be designed in accordance with the relevant application standards.
- Crimping shape "A" for wire end ferrules with PZ 6/5 crimping tool are recommended for the largest cable sizes.

LS2HF 3.50/./90



Dimensioned drawing

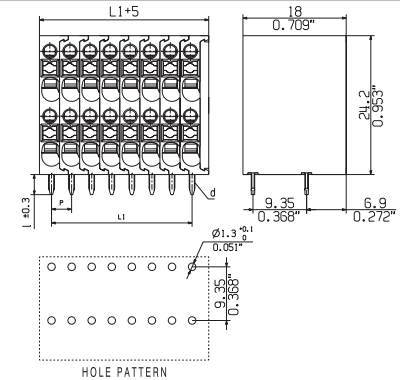

Ordering data

<b>Solder pin length</b>		3.5 mm		
<b>Colour</b>		Orange		
<b>Pitch</b>		3.50 mm		
Pol.	L1	(inch)	Qty.	Order No.
4	3.50	0.138	100	2000940000
6	7.00	0.276	100	2000950000
8	10.50	0.413	100	2000960000
10	14.00	0.551	100	2000970000
12	17.50	0.689	50	2000980000
14	21.00	0.827	50	2000990000
16	24.50	0.965	50	2001000000
18	28.00	1.102	50	2001010000
20	31.50	1.240	50	2001020000
22	35.00	1.378	20	2001030000
24	38.50	1.516	20	2001040000

Representative deratings curve

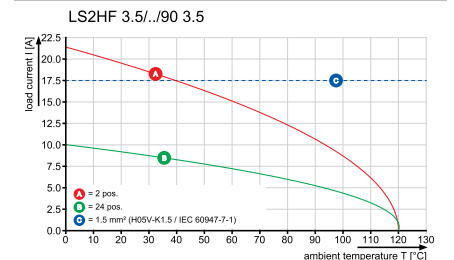



LMZF & LMZFL 5../135

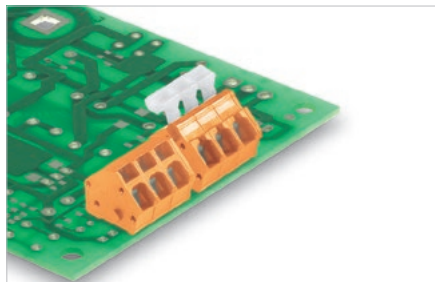

The compact installation terminal with tension clamp spring connection in 5.0x-mm pitch for wire cross-sections up to 2.5 mm<sup>2</sup>.

- Variable pitch: 5.00 - 5.08 mm
- 1 component = 2 pitches
- Wire outlet direction: 135° version
- Convenient: optional lever for opening the contact point.

Technical data

<b>In compliance with IEC 60664-1 / IEC 61984</b>			
Clamping range, max.	mm <sup>2</sup>	0.13...2.5	
<b>Solid core H05(07) V-U</b>	mm <sup>2</sup>	<b>0.13...2.5</b>	
Stranded H07 V-R			
Flexible H05(07) V-K	mm <sup>2</sup>	0.13...2.5	
Flexible with ferrule	mm <sup>2</sup>	0.25...1.5	
Ferrule with plastic collar	mm <sup>2</sup>	0.25...1.5	
Stripping length	mm	6	
Screwdriver blade	mm	0.4 x 2.5	
According to norm		DIN 5264-A	
Tightening torque range			
<b>Rated current, max.</b>	<b>A</b>	<b>24</b>	<b>24</b>
At ambient temperature		20°C	40°C
For conductor cross-section		III	III II
Overtoltage category		3	2 2
Pollution severity		3	2 2
<b>Rated voltage</b>	<b>V</b>	<b>250</b>	<b>320 630</b>
Rated impulse voltage	kV	4	4 4
<b>UL / CUL (Use Group)</b>		<b>B</b>	<b>C D</b>
<b>Rated voltage</b>	<b>V</b>	<b>300</b>	<b>300</b>
<b>Rated current</b>	<b>A</b>	<b>15</b>	<b>10</b>
<b>AWG conductor</b>	<b>AWG</b>	<b>26-14</b>	
<b>CSA (Use Group)</b>		<b>B</b>	<b>C D</b>
Rated voltage	V	300	300
Rated current	A	10	10
AWG conductor	AWG	26-14	
<b>General data</b>			
Type of insulation material		Wemid (PA)	
UL 94 flammability rating		V-0	
Contact base material		Copper alloy	
Material of contact surface		tinned	
Pin dimensions = d	mm	0.8 x 0.8	
Solder eyelet Ø = D	mm	1.3	
Solder eyelet Ø tolerance	mm	+ 0,1	

Product data

IEC: 630 V / 24 A / 0.13 - 2.5 mm<sup>2</sup>  
 UL: 300 V / 15 A / AWG 26 - 14



For additional articles and information, refer to [catalog.weidmueller.com](http://catalog.weidmueller.com)

Note:

- Rated current related to rated cross-section & min. No. of poles.
- Wire end ferrule without plastic collar to DIN 46228/1
- Wire end ferrule with plastic collar to DIN 46228/4
- P on drawing = pitch
- Rated data refer only to the component itself. Clearance and creepage distances to other components are to be designed in accordance with the relevant application standards.

LMZF 5../135



Dimensioned drawing

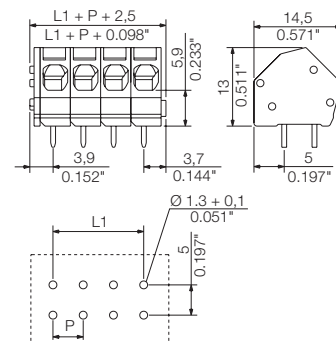

Accessories

Note: Refer to the Accessories chapter for additional accessories.

Screwdriver		Order No.
	SDS 0.6X3.5X100	9008330000
	SDIS 0.6X3.5X100	9008390000

Ordering data

Solder pin length		3.5 mm		
Colour		Orange		
Pitch	5.00 mm			
Pol.	L1	(inch)	Qty.	Order No.
2	5.00	0.197	100	1913780000
3	10.00	0.394	100	1913820000
4	15.00	0.591	100	1913960000
5	20.00	0.787	100	1914000000
6	25.00	0.984	100	1914020000
7	30.00	1.181	100	1914030000
8	35.00	1.378	100	1914040000
9	40.00	1.575	100	1914050000
10	45.00	1.772	100	1914070000
11	50.00	1.969	100	1914080000
12	55.00	2.165	100	1914090000
13	60.00	2.362	100	1960140000
14	65.00	2.559	100	1960150000
15	70.00	2.756	100	1960160000
16	75.00	2.953	100	1960170000
17	80.00	3.150	50	1960180000
18	85.00	3.346	50	1960190000
19	90.00	3.543	50	1960200000
20	95.00	3.740	50	1960210000
21	100.00	3.937	50	1960220000
22	105.00	4.134	50	1960230000
23	110.00	4.331	50	1960240000
24	115.00	4.528	50	1960250000

Representative deratings curve

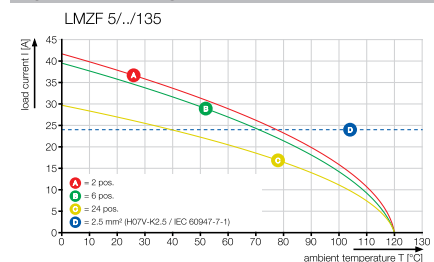



LMZFL 5/./135



Dimensioned drawing

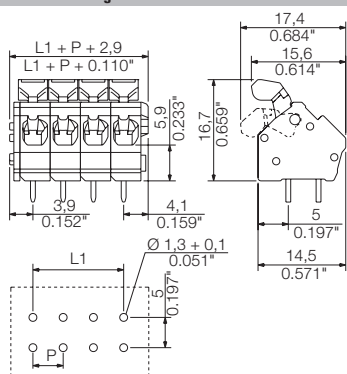

Ordering data

Solder pin length		3.5 mm		
Colour		Orange		
Pitch		5.00 mm		
Pol.	L1	(inch)	Qty.	Order No.
2	5.00	0.197	100	1914560000
3	10.00	0.394	100	1914580000
4	15.00	0.591	100	1914590000
5	20.00	0.787	100	1914600000
6	25.00	0.984	100	1914640000
7	30.00	1.181	100	1914720000
8	35.00	1.378	100	1914790000
9	40.00	1.575	100	1914830000
10	45.00	1.772	100	1914860000
11	50.00	1.969	100	1914990000
12	55.00	2.165	100	1915030000
13	60.00	2.362	50	1958320000
14	65.00	2.559	50	1958330000
15	70.00	2.756	50	1958350000
16	75.00	2.953	50	1958370000
17	80.00	3.150	50	1958390000
18	85.00	3.346	50	1958410000
19	90.00	3.543	50	1958440000
20	95.00	3.740	50	1958450000
21	100.00	3.937	50	1958470000
22	105.00	4.134	50	1958490000
23	110.00	4.331	50	1958500000
24	115.00	4.528	50	1958510000

Additional deratings curves

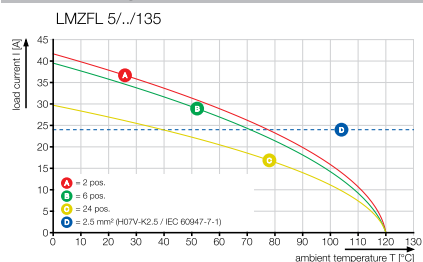

LMZF & LMZF 7../135

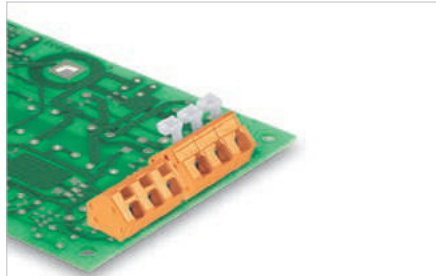

The compact installation terminal with tension clamp spring connection in 7.xx mm pitch for wire cross-sections up to 2.5 mm<sup>2</sup>.

- Variable pitch: 7.50 - 7.62 mm
- 1 component = 2 pitches
- Wire outlet direction: 135° version
- Convenient: optional lever for opening the contact point.

Technical data

In compliance with IEC 60664-1 / IEC 61984			
Clamping range, max.	mm <sup>2</sup>	0.13...2.5	
<b>Solid core H05(07) V-U</b>	mm <sup>2</sup>	<b>0.13...2.5</b>	
Stranded H07 V-R			
Flexible H05(07) V-K	mm <sup>2</sup>	0.13...2.5	
Flexible with ferrule	mm <sup>2</sup>	0.25...1.5	
Ferrule with plastic collar	mm <sup>2</sup>	0.25...1.5	
Stripping length	mm	6	
Screwdriver blade	mm	0.6 x 3.5	
According to norm		DIN 5264-A	
Tightening torque range			
<b>Rated current, max.</b>	<b>A</b>	<b>24</b>	<b>24</b>
At ambient temperature		20°C	40°C
For conductor cross-section			
Overtoltage category		III	III II
Pollution severity		3	2 2
<b>Rated voltage</b>	<b>V</b>	<b>400</b>	<b>800 1000</b>
Rated impulse voltage	kV	6	6 6
<b>UL / CUL (Use Group)</b>	<b>B C D</b>	<b>B</b>	<b>C D</b>
<b>Rated voltage</b>	<b>V</b>	<b>300</b>	<b>150 300</b>
<b>Rated current</b>	<b>A</b>	<b>15</b>	<b>15 10</b>
<b>AWG conductor</b>	<b>AWG</b>	<b>26-14</b>	
<b>CSA (Use Group)</b>	<b>B C D</b>	<b>B</b>	<b>C D</b>
Rated voltage	V	300	150 300
Rated current	A	15	15 10
AWG conductor	AWG	26-14	
<b>General data</b>			
Type of insulation material		Wemid (PA)	
UL 94 flammability rating		V-0	
Contact base material		Copper alloy	
Material of contact surface		tinned	
Pin dimensions = d	mm	0.8 x 0.8	
Solder eyelet Ø = D	mm	1.3	
Solder eyelet Ø tolerance	mm	+ 0,1	

Product data

IEC: 1000 V / 24 A / 0.13 - 2.5 mm<sup>2</sup>  
 UL: 300 V / 15 A / AWG 26 - 14



For additional articles and information, refer to [catalog.weidmueller.com](http://catalog.weidmueller.com)

Note:

- Rated current related to rated cross-section & min. No. of poles.
- Wire end ferrule without plastic collar to DIN 46228/1
- Wire end ferrule with plastic collar to DIN 46228/4
- P on drawing = pitch
- Rated data refer only to the component itself. Clearance and creepage distances to other components are to be designed in accordance with the relevant application standards.

LMZF 7../135



Dimensioned drawing

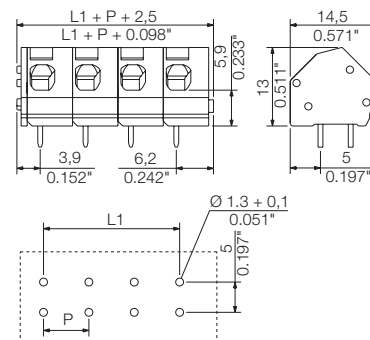

Accessories

Note: Refer to the Accessories chapter for additional accessories.

Screwdriver		Order No.
	SDS 0.6X3.5X100	9008330000
	SDIS 0.6X3.5X100	9008390000

Ordering data

Solder pin length		3.5 mm		
Colour		Orange		
Pitch		7.50 mm		
Pol.	L1	(inch)	Qty.	Order No.
2	7.50	0.295	100	1952570000
3	15.00	0.591	100	1952580000
4	22.50	0.886	100	1952590000
5	30.00	1.181	100	1952600000
6	37.50	1.476	100	1952610000
7	45.00	1.772	100	1952620000
8	52.50	2.067	100	1952630000
9	60.00	2.362	100	1952640000
10	67.50	2.657	100	1952650000
11	75.00	2.953	100	1952660000
12	82.50	3.248	100	1952670000

Representative deratings curve

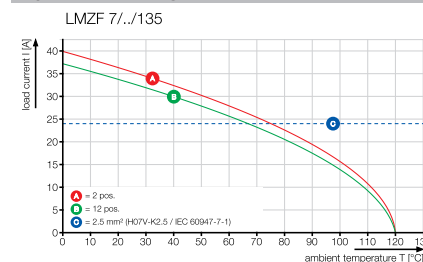

LMZFL 7../135



Dimensioned drawing

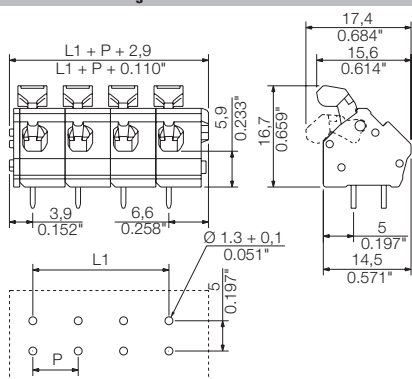

Ordering data

Solder pin length		3.5 mm	
Colour		Orange	
Pitch		7.50 mm	
Pol.	L1	(inch)	Qty. Order No.
2	7.50	0.295	100 1953010000
3	15.00	0.591	100 1953020000
4	22.50	0.886	100 1953030000
5	30.00	1.181	100 1953040000
6	37.50	1.476	100 1953050000
7	45.00	1.772	100 1953060000
8	52.50	2.067	100 1953070000
9	60.00	2.362	100 1953080000
10	67.50	2.657	100 1953090000
11	75.00	2.953	100 1953100000
12	82.50	3.248	100 1953110000

Additional deratings curves

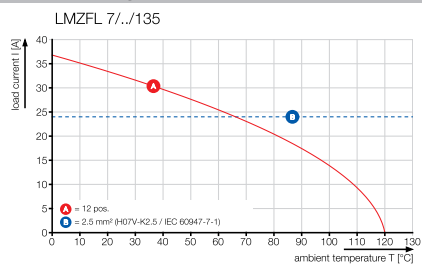

LMZF & LMZF 10../135

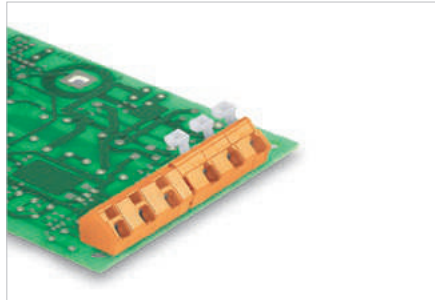

The compact installation terminal with tension clamp spring connection in 10.xx-mm pitch for wire cross-sections up to 2.5 mm<sup>2</sup>.

- Variable pitch 10.00 - 10.16 mm
- 1 component = 2 pitches
- Wire outlet direction: 135° version
- Convenient: optional lever for opening the contact point.

Technical data

<b>In compliance with IEC 60664-1 / IEC 61984</b>			
Clamping range, max.	mm <sup>2</sup>	0.13...2.5	
<b>Solid core H05(07) V-U</b>	mm <sup>2</sup>	<b>0.13...2.5</b>	
Stranded H07 V-R			
Flexible H05(07) V-K	mm <sup>2</sup>	0.13...2.5	
Flexible with ferrule	mm <sup>2</sup>	0.25...1.5	
Ferrule with plastic collar	mm <sup>2</sup>	0.25...1.5	
Stripping length	mm	6	
Screwdriver blade	mm	0.6 x 3.5	
According to norm		DIN 5264	
Tightening torque range			
<b>Rated current, max.</b>	<b>A</b>	<b>24</b>	<b>24</b>
At ambient temperature		20°C	40°C
For conductor cross-section			
Overtoltage category		III	III II
Pollution severity		3	2 2
<b>Rated voltage</b>	<b>V</b>	<b>500</b>	<b>1000 1000</b>
Rated impulse voltage	kV	8	8 8
<b>UL / CUL (Use Group)</b>		<b>B</b>	<b>C D</b>
<b>Rated voltage</b>	<b>V</b>	<b>300</b>	<b>150 300</b>
<b>Rated current</b>	<b>A</b>	<b>15</b>	<b>15 10</b>
<b>AWG conductor</b>	<b>AWG</b>	<b>26-14</b>	
<b>CSA (Use Group)</b>		<b>B</b>	<b>C D</b>
Rated voltage	V	300	150 300
Rated current	A	15	15 10
AWG conductor	AWG	26-14	
<b>General data</b>			
Type of insulation material		Wemid (PA)	
UL 94 flammability rating		V-0	
Contact base material		Copper alloy	
Material of contact surface		tinned	
Pin dimensions = d	mm	0.8 x 0.8	
Solder eyelet Ø = D	mm	1.3	
Solder eyelet Ø tolerance	mm	+ 0,1	

Product data

IEC: 1000 V / 24 A / 0.13 - 2.5 mm<sup>2</sup>  
 UL: 300 V / 15 A / AWG 26 - 14



For additional articles and information, refer to [catalog.weidmueller.com](http://catalog.weidmueller.com)

Note:

- Rated current related to rated cross-section & min. No. of poles.
- Wire end ferrule without plastic collar to DIN 46228/1
- Wire end ferrule with plastic collar to DIN 46228/4
- P on drawing = pitch
- Rated data refer only to the component itself. Clearance and creepage distances to other components are to be designed in accordance with the relevant application standards.

LMZF 10../135



Dimensioned drawing

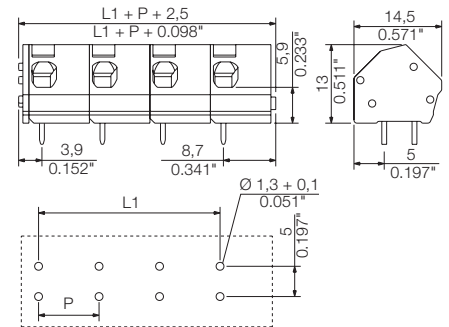

Accessories

Note: Refer to the Accessories chapter for additional accessories.

Screwdriver		Order No.
	SDS 0.6X3.5X100	9008330000
	SDIS 0.6X3.5X100	9008390000

Ordering data

Solder pin length		3.5 mm		
Colour		Orange		
Pitch	10.00 mm			
Pol.	L1	(inch)	Qty.	Order No.
2	10.00	0.394	100	1953470000
3	20.00	0.787	100	1953480000
4	30.00	1.181	100	1953490000
5	40.00	1.575	100	1953500000
6	50.00	1.969	100	1953510000
7	60.00	2.362	100	1953520000
8	70.00	2.756	100	1953530000
9	80.00	3.150	100	1953540000
10	90.00	3.543	100	1953550000
11	100.00	3.937	100	1953560000
12	110.00	4.331	100	1953570000

Representative deratings curve

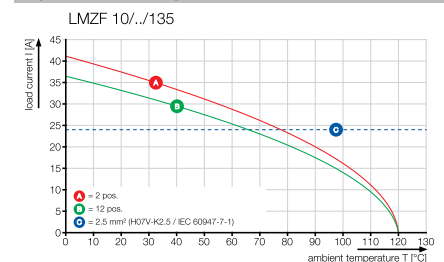

LMZFL 10../135



Dimensioned drawing

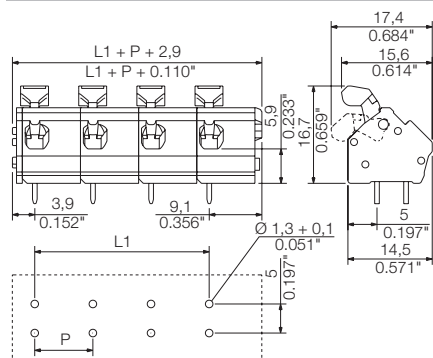

Ordering data

Solder pin length		3.5 mm		
Colour		Orange		
Pitch		10.00 mm		
Pol.	L1	(inch)	Qty.	Order No.
2	10.00	0.394	100	1953930000
3	20.00	0.787	100	1953940000
4	30.00	1.181	100	1953950000
5	40.00	1.575	100	1953960000
6	50.00	1.969	100	1953970000
7	60.00	2.362	100	1953980000
8	70.00	2.756	100	1953990000
9	80.00	3.150	100	1954000000
10	90.00	3.543	100	1954010000
11	100.00	3.937	100	1954020000
12	110.00	4.331	100	1954030000

Additional deratings curves

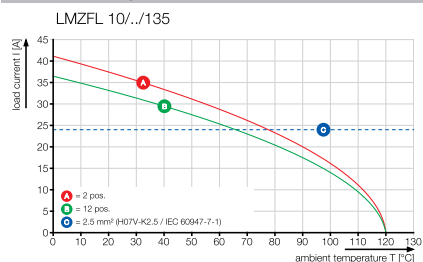

LMZF 5.08, multi-level

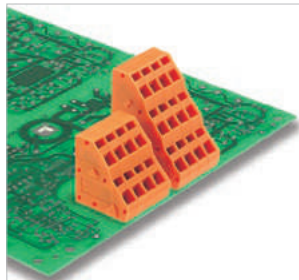

The high-performance device interface with a high connection density. Multi-level PCB terminal with tension clamp spring connection in 5.08 mm pitch for wire cross-sections up to 2.5 mm<sup>2</sup>.

- Wire outlet direction: 135° version
- Simple switching of connection system - layout compatible with multi-level screw terminals.

Technical data

<b>In compliance with IEC 60664-1 / IEC 61984</b>			
Clamping range, max.	mm <sup>2</sup>	0.13...2.5	
<b>Solid core H05(07) V-U</b>	mm <sup>2</sup>	<b>0.2...2.5</b>	
Stranded H07 V-R			
Flexible H05(07) V-K	mm <sup>2</sup>	0.2...1.5	
Flexible with ferrule	mm <sup>2</sup>	0.25...1.5	
Ferrule with plastic collar	mm <sup>2</sup>	0.25...1.5	
Stripping length	mm	7.5	
Screwdriver blade	mm	0.6 x 3.5	
According to norm		DIN 5264-A	
Tightening torque range			
<b>Rated current, max.</b>	<b>A</b>	<b>15</b>	<b>13</b>
At ambient temperature		20°C	40°C
For conductor cross-section			
Overtoltage category		III	III II
Pollution severity		3	2 2
<b>Rated voltage</b>	<b>V</b>	<b>250</b>	<b>320 630</b>
Rated impulse voltage	kV	4	4 4
<b>UL / CUL (Use Group)</b>		<b>B</b>	<b>C D</b>
<b>Rated voltage</b>	<b>V</b>	<b>300</b>	<b>300</b>
<b>Rated current</b>	<b>A</b>	<b>10</b>	<b>10</b>
<b>AWG conductor</b>	<b>AWG</b>	<b>24-14</b>	
<b>CSA (Use Group)</b>		<b>B</b>	<b>C D</b>
Rated voltage	V	300	300
Rated current	A	10	10
AWG conductor	AWG	24-14	
<b>General data</b>			
Type of insulation material		PA	
UL 94 flammability rating		V-0	
Contact base material			
Material of contact surface			
Pin dimensions = d	mm	0.8 x 1.0	
Solder eyelet Ø = D	mm	1.3	
Solder eyelet Ø tolerance	mm	+ 0,1	

Product data

IEC: 630 V / 15 A / 0.2 - 2.5 mm<sup>2</sup>  
 UL: 300 V / 10 A / AWG 24 - 14



For additional articles and information, refer to [catalog.weidmueller.com](http://catalog.weidmueller.com)

Note:

- Rated current related to rated cross-section & min. No. of poles.
- Wire end ferrule without plastic collar to DIN 46228/1
- Wire end ferrule with plastic collar to DIN 46228/4
- P on drawing = pitch
- Rated data refer only to the component itself. Clearance and creepage distances to other components are to be designed in accordance with the relevant application standards.

LM2NZF 5.08../135



Dimensioned drawing

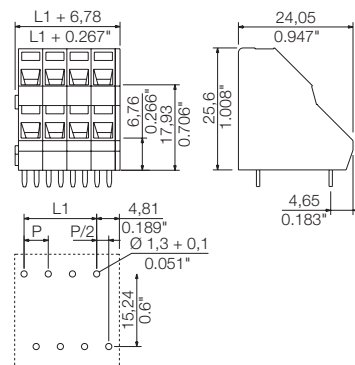

Accessories

Note: Refer to the Accessories chapter for additional accessories.

Screwdriver		Order No.
	SDS 0.6X3.5X100	9008330000
	SDIS 0.6X3.5X100	9008390000

Ordering data

Solder pin length		3.5 mm		
Colour		Orange		
Pitch	5.08 mm			
Pol.	L1	(inch)	Qty.	Order No.
4	5.08	0.200	50	1764810000
6	10.16	0.400	50	1764820000
8	15.24	0.600	50	1764830000
10	20.32	0.800	50	1764840000
12	25.40	1.000	50	1764850000
14	30.48	1.200	20	1764860000
16	35.56	1.400	20	1764870000
18	40.64	1.600	20	1764880000
20	45.72	1.800	20	1758020000
22	50.80	2.000	20	1764890000
24	55.88	2.200	10	1764900000
26	60.96	2.400	10	1782500000
28	66.04	2.600	10	1782510000
30	71.12	2.800	10	1782520000
32	76.20	3.000	10	1782530000
34	81.28	3.200	10	1782540000
36	86.36	3.400	10	1782550000

Representative deratings curve

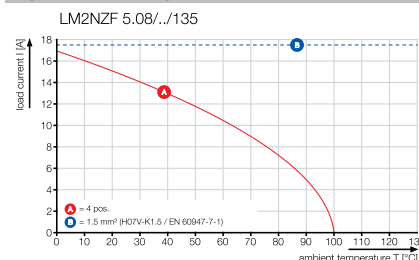

LM3RZF 5.08/./135



Dimensioned drawing

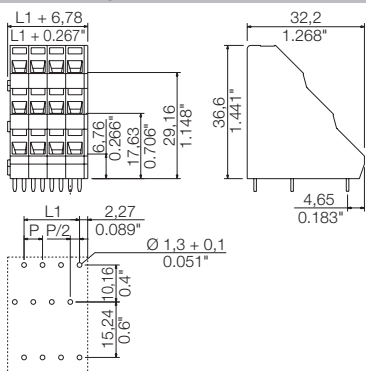

Ordering data

Solder pin length		3.5 mm		
Colour		Orange		
Pitch		5.08 mm		
Pol.	L1	(inch)	Qty.	Order No.
6	5.08	0.200	50	1764910000
9	10.16	0.400	50	1764920000
12	15.24	0.600	50	1764930000
15	20.32	0.800	20	1764940000
18	25.40	1.000	20	1764950000
21	30.48	1.200	20	1758040000
24	35.56	1.400	10	1764960000
27	40.64	1.600	10	1764970000
30	45.72	1.800	10	1758030000
33	50.80	2.000	10	1764980000
36	55.88	2.200	10	1764990000
48	76.20	3.000	10	1758050000

Additional deratings curves

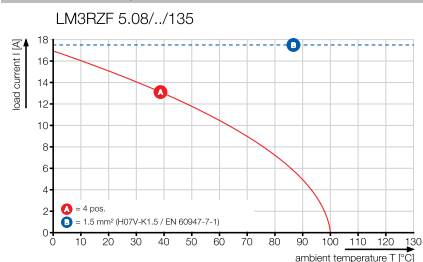





# OMNIMATE® Signal PCB connectors in 2.50 mm pitch

**OMNIMATE® Signal**  
**PCB connectors in 2.50 mm pitch**

PCB connectors in 2.50 mm pitch  
Serie BLF 2.50/SL 2.50

Explanation	D.2
Quick selection	D.4

## Use compact, functional connection solutions

### BLF 2.5/SL 2.5 PUSH IN device connectors

Especially for controls, I/O systems and signal interfaces in drive technology, it is now a question of ensuring components are as compact as possible while offering excellent functionality and simple handling.

The new BLF 2.5 OMNIMATE® signal plug-in connector and the associated SL 2.5 male connectors combine these requirements. This is thanks to the space-saving design and the particularly quick PUSH IN connection system – optimised for wire cross-sections of up to 0.5 mm<sup>2</sup> and a pitch dimension of 2.5 mm.

The BLF 2.5 connector has an integrated pusher to make opening the contact point easier. There is also an additional test point for user-friendly service measurements on the device. The SL 2.5 male header has two available outlet directions in various device designs and ensures excellent accessibility to the connector even in confined spaces.

#### Pusher gives operational safety

The contact point can be opened easily and the conductor removed by pressing the "pusher". This allows particularly fast and uniform wiring.

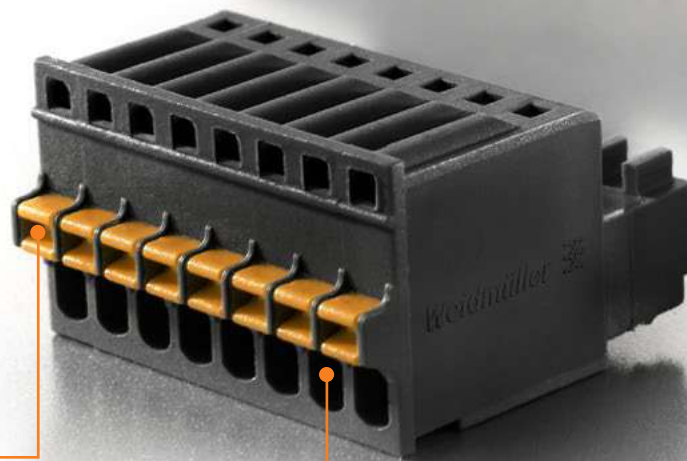

**Flexible application**

The SL 2.5 male header has two available outlet directions and can be used in many device designs. This means good connector availability can be guaranteed, even in confined spaces.



**Optimum handling with minimum space requirements**

All in one: the BLF 2.5 means you can benefit from a compact, pluggable connection solution for devices which is also simple.



Quick and safe wiring with high connection density: the PCB connectors in a 2.5 mm pitch enable space-saving signal interfaces for a variety of devices, for example, industrial controls.

**PUSH IN connector up to 0.5 mm<sup>2</sup>**

Wires with wire-end ferrules and single-stranded wires can be inserted directly thanks to the PUSH IN connection technology which saves time and ensures reliable contacting.

**High component density**

The compact design with PUSH IN connections and very small 2.5 mm pitch size is perfectly suited for wire cross-sections of up to 0.5 mm<sup>2</sup>.



<http://www.OMNIMATE.net>

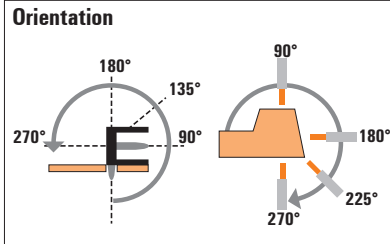
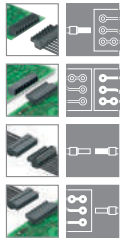

- = Wire-to-Board
- = Board-to-Board
- = Wire-to-Wire
- = Board-to-Wire



## Serie BLF/2.50/SL 2.50

Levels

Type	Orientation	
	Flange options	
	IEC / UL	

Female plug	 <b>Spring PUSH IN</b>		BLF	180°	(G)	IEC: 320 V / 6 A / 0.08 - 0.5 mm <sup>2</sup>
						UL: 150 V / 5 A / AWG 28 - 20

**Female connector:**  
**(G)\*** = Closed (without flange)  
**F** = Screw flange with screw  
**LH** = Release lever  
**LR** = Lock & Release lever

**Male header:**  
**G** = Closed (without flange)  
**F** = Screw flange with nut  
**LF** = Solder flange with nut

\* not included in the article description

Male header



Solder connection



1

SL	SL
90°	180°
G	G
IEC: 320 V/6 A UL: 150 V/5 A	IEC: 320 V/6 A UL: 150 V/5 A
○	○

## Connectors in 2.50 mm pitch BLF 2.50 / SL 2.50

### SL 2.50../90G and 180G

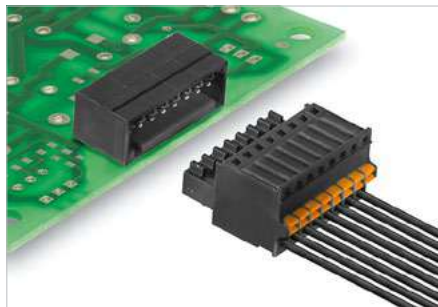

Male header for wave soldering in 2.50mm pitch.

- Plugging direction is parallel (90°) or straight 180° to the PCB
- Housing variant: Closed (G)
- Packaged in a cardboard box (BX)

### Product data

IEC: 320 V / 6 A  
UL: 150 V / 5 A



For additional articles and information, refer to [catalog.weidmuller.com](http://catalog.weidmuller.com)

#### Note:

- Rated current related to rated cross-section & min. No. of poles.
- P on drawing = pitch
- Rated data refer only to the component itself. Clearance and creepage distances to other components are to be designed in accordance with the relevant application standards.

### SL 2.50../90G Box

closed side



#### Dimensioned drawing

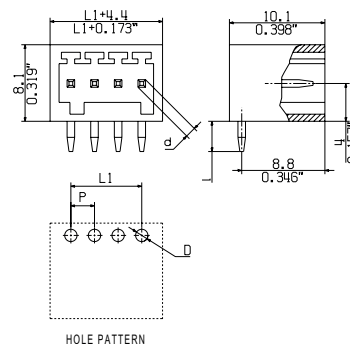

### Technical data

#### In compliance with IEC 60664-1 / IEC 61984

Clamping range, max.			
<b>Solid core H05(07) V-U</b>			
Stranded H07 V-R			
Flexible H05(07) V-K			
Flexible with ferrule			
Ferrule with plastic collar			
Stripping length			
Screwdriver blade	mm		
According to norm			
Tightening torque range			
<b>Rated current, max.</b>	<b>6</b>	<b>6</b>	
At ambient temperature	20°C	40°C	
For conductor cross-section			
Overvoltage category	III	III	II
Pollution severity	3	2	2
<b>Rated voltage</b>	<b>V</b>	<b>80</b>	<b>320</b>
Rated impulse voltage	kV	2.5	2.5
<b>UL / CUL (Use Group)</b>	<b>B</b>	<b>C</b>	<b>D</b>

<b>Rated voltage</b>	<b>V</b>	<b>150</b>
<b>Rated current</b>	<b>A</b>	<b>5</b>
<b>AWG conductor</b>	<b>AWG</b>	-
<b>CSA (Use Group)</b>	<b>B</b>	<b>C</b>
Rated voltage	V	150
Rated current	A	5
AWG conductor	AWG	-

<b>General data</b>		
Type of insulation material		PA 66
UL 94 flammability rating		V-0
Contact base material		Copper alloy
Material of contact surface		tinned
Pin dimensions = d	mm	0.8 x 0.8
Solder eyelet Ø = D	mm	1.3
Solder eyelet Ø tolerance	mm	+ 0,1

### Accessories

Note: Refer to the Accessories chapter for additional accessories.

### Ordering data

<b>Solder pin length</b>		<b>3.2 mm</b>		
<b>Colour</b>		<b>Black</b>		
<b>Pitch</b>		<b>2.50 mm</b>		
Pol.	L1	(inch)	Qty.	Order No.
2	2.50	0.984	250	2439660000
3	5.00	1.968	250	2439760000
4	7.50	2.952	250	2439770000
5	10.00	3.936	200	2439780000
6	12.50	4.920	175	2439790000
7	15.00	5.904	125	2439800000
8	17.50	6.888	125	2439810000
9	20.00	7.872	125	2439820000
10	22.50	8.856	100	2439830000
11	25.00	9.840	100	2439840000
12	27.50	10.824	75	2439850000

2.50

90°

## SL 2.50/.../180G Box

closed side



Dimensioned drawing

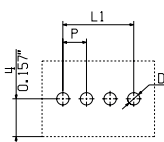
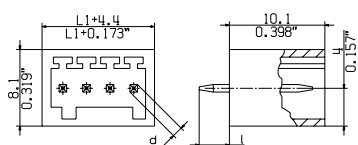

HOLE PATTERN

### Ordering data

Solder pin length		3.2 mm		
Colour		Black		
Pitch		2.50 mm		
Pol.	L1	(inch)	Qty.	Order No.
2	2.50	0.984	250	2439910000
3	5.00	1.968	250	2439920000
4	7.50	2.952	250	2439930000
5	10.00	3.936	200	2439940000
6	12.50	4.920	175	2439950000
7	15.00	5.904	125	2439960000
8	17.50	6.888	125	2439970000
9	20.00	7.872	125	2439980000
10	22.50	8.856	100	2439990000
11	25.00	9.840	100	2440000000
12	27.50	10.824	75	2440010000

## Connectors in 2.50 mm pitch BLF 2.50 / SL 2.50

### BLF 2.50/./180

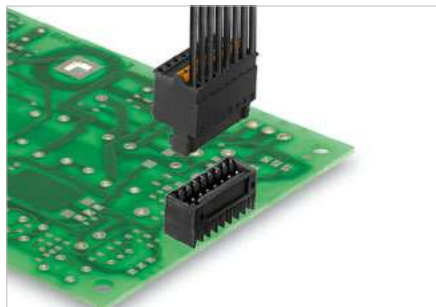

**PUSH IN** - Weidmüller's innovative connection system simplifies the wire connection process.

The benefits for users and applications:

- High component density because of small pitch.  
Simply insert the prepared wire - and you're done
- Simplified processing, featuring integrated push buttons for opening the wire-terminal point
- Intuitive handling - since the wire-entry area and handling area are clearly separated

### Technical data

#### In compliance with IEC 60664-1 / IEC 61984

Clamping range, max.	mm <sup>2</sup>	0.08...0.5	
<b>Solid core H05(07) V-U</b>	<b>mm<sup>2</sup></b>	<b>0.08...0.5</b>	
Stranded H07 V-R		...0.5	
Flexible H05(07) V-K	mm <sup>2</sup>	0.08...0.5	
Flexible with ferrule	mm <sup>2</sup>	0.25...0.34	
Ferrule with plastic collar			
Stripping length	mm	8	
Screwdriver blade	mm		
According to norm		DIN 5264	
Tightening torque range			
<b>Rated current, max.</b>	<b>A</b>	<b>6</b>	<b>6</b>
At ambient temperature		20°C	40°C
For conductor cross-section			
Overtoltage category		III	III II
Pollution severity		3	2 2
<b>Rated voltage</b>	<b>V</b>	<b>80</b>	<b>320 320</b>
Rated impulse voltage	kV	2.5	2.5 2.5
<b>UL / CUL (Use Group)</b>		<b>B</b>	<b>C D</b>

<b>Rated voltage</b>	<b>V</b>	<b>150</b>
<b>Rated current</b>	<b>A</b>	<b>5</b>
<b>AWG conductor</b>	<b>AWG</b>	<b>28-20</b>
<b>CSA (Use Group)</b>		<b>B C D</b>
Rated voltage	V	150
Rated current	A	5
AWG conductor	AWG	28-20

#### General data

Type of insulation material		PA
UL 94 flammability rating		V-0
Contact base material		Copper alloy
Material of contact surface		tinned
Pin dimensions = d	mm	
Solder eyelet Ø = D		
Solder eyelet Ø tolerance	mm	

### Product data

IEC: 320 V / 6 A / 0.08 - 0.5 mm<sup>2</sup>  
UL: 150 V / 5 A / AWG 28 - 20



For additional articles and information, refer to [catalog.weidmueller.com](http://catalog.weidmueller.com)

#### Note:

- Rated current related to rated cross-section & min. No. of poles.
- P on drawing = pitch
- Crimp shape A for wire-end ferrules with crimping tools PZ 1,5 (order no. 9005990000) or PZ 6/5 (order no. 9011460000) for larger wire cross-sections recommended.
- Rated data refer only to the component itself. Clearance and creepage distances to other components are to be designed in accordance with the relevant application standards.

### BLF 2.50/./180



#### Dimensioned drawing

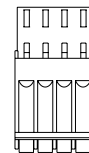
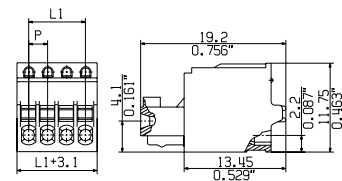

### Accessories

**Note:** Refer to the Accessories chapter for additional accessories.

### Ordering data

Solder pin length				
Colour				Black
Pitch	2.50 mm		Qty.	Order No.
2	2.50	0.984	250	2438860000
3	5.00	1.968	250	2439650000
4	7.50	2.952	250	2439670000
5	10.00	3.936	200	2439680000
6	12.50	4.920	175	2439690000
7	15.00	5.904	125	2439700000
8	17.50	6.888	125	2439710000
9	20.00	7.872	125	2439720000
10	22.50	8.856	100	2439730000
11	25.00	9.840	100	2439740000
12	27.50	10.824	75	2439750000

2.50

180°

0.5 mm<sup>2</sup>



# OMNIMATE® Signal PCB connectors in 3.50 mm pitch

<b>OMNIMATE® Signal PCB connectors in 3.50 mm pitch</b>	Double-row connectors in 3.50 mm pitch Series B2C/S2C 3.50	Explanation	E.2
		Quick selection	E.4
		Product selection	E.6
	Connectors in 3.50 mm pitch Series BL/SL 3.50	Explanation	E.20
		Quick selection	E.28
		Product selection	E.30



# Powerful compact connector with PUSH IN wire connection

## OMNIMATE® Signal – simple and safe connection for wires up to 1.5 mm<sup>2</sup>

When designing customised device connectivity products for modern applications, it is becoming increasingly important to find the perfect fit between device miniaturisation and increased device functionality. Our new double-row OMNIMATE® B2CF Signal connector, in 3.5 mm pitch, has this perfect fit and enables a new generation of more compact installations.

This connector is easy to work with, despite the increased functionality being packed into a compact space. The PUSH IN direct-insert wire connection mechanism allows you to conveniently connect the signal wires. There are more useful features: the tool-free locking and unlocking, the touch-safe male header, and the outstanding clarity provided by easy-to-read markers that identify each terminal point.

### Packing Density 2.0

Smaller devices with increased technical capabilities are being designed for more applications. They take advantage of more contacts packed onto a small surface and a large wire cross-section capacity.

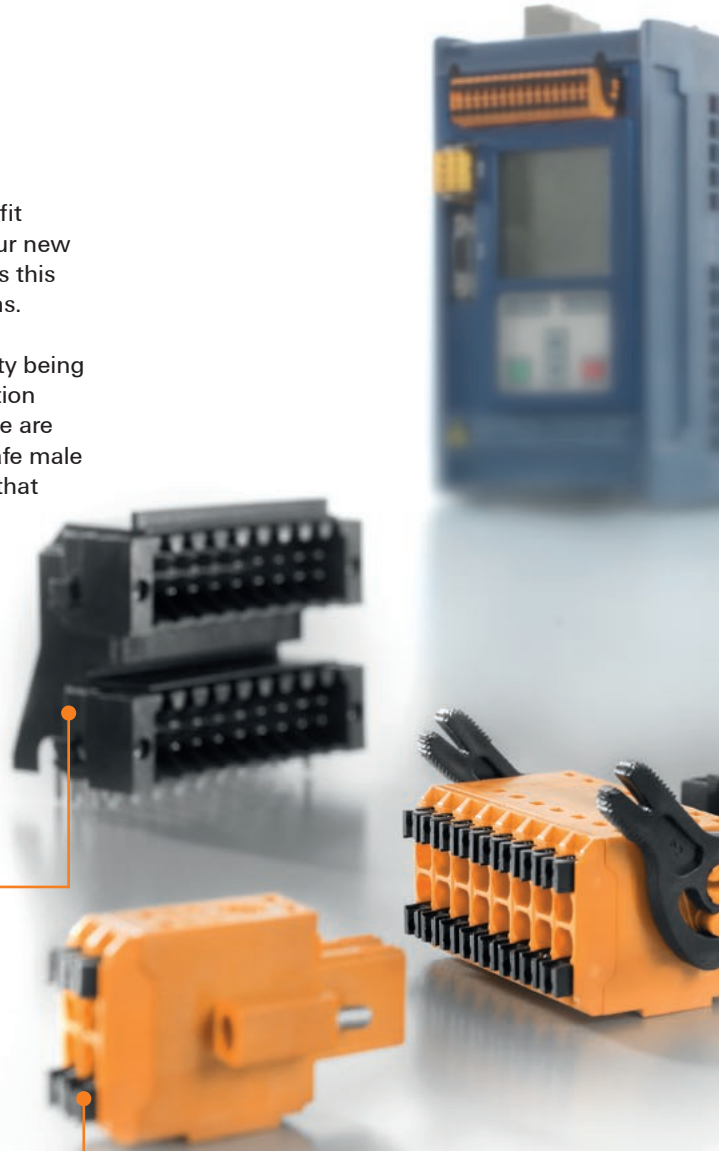
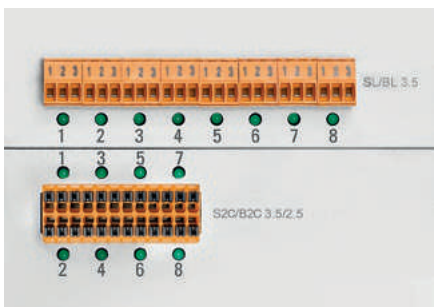

### Clear frontal marking

Clarity is enhanced with clearly legible markers at each terminal point and unique labelling of the installation position.



**Large wire cross-sections**

You can easily connect wires with cross-sections up to 1.5 mm<sup>2</sup> (when using wire-end ferrules) and up to 1.0 mm<sup>2</sup> (when using ferrules and plastic collars).

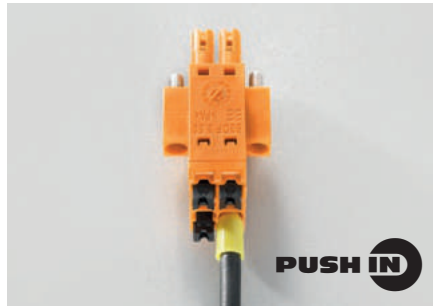

**Direct insertion**

PUSH IN: the quick, tool-free, intuitive connection mechanism for prepared wires. [www.push-in.com](http://www.push-in.com)

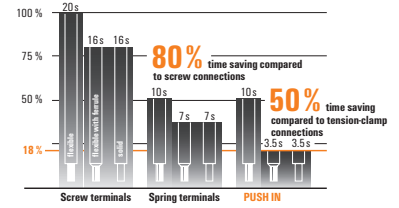

**Halogen-free and IEC 60335**

Halogen-free materials ensure future compatibility and extended approvals enhance the range of use for new device designs.

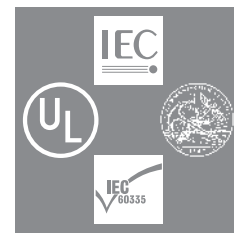

**Convincing system accessories**

Our matching accessories – including markers, light guides, strain relief and coding – improve operational safety and enable a professional design.



**Convincing safety during use**

This connector system is safe to use, with attractive features such as quick wire connections, tool-free locking and unlocking, and touch-safe design.

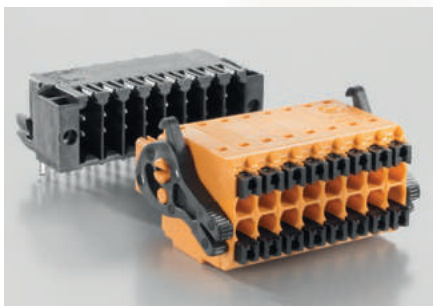





**Solid PUSH IN contacts**

A safe, permanent connection is ensured by the optimised spring steel and specially-shaped contact element.



<http://www.OMNIMATE.net>

-  = Wire-to-Board
-  = Board-to-Board
-  = Wire-to-Wire
-  = Board-to-Wire

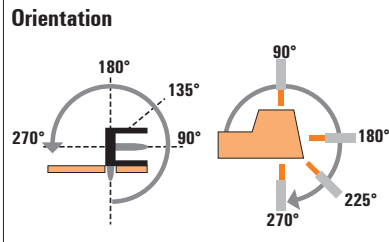
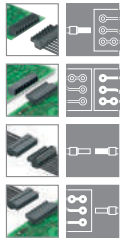

### B2C/S2C 3.50 series





Type		Levels	
		Orientation	Flange options
		IEC / UL	

Female plug	Spring PUSH IN			B2CF	180°	(G)/F/LR	IEC: 320 V/13.4 A/0.14 - 1.5 mm <sup>2</sup> UL: 300 V/10 A/AWG 26 - 16
	Tension clamp (with internal cross connection)						

**Female connector:**  
**(G)\*** = Closed (without flange)  
**F** = Screw flange with screw  
**LH** = Release lever  
**LR** = Lock & Release lever

**Male header:**  
**G** = Closed (without flange)  
**F** = Screw flange with nut  
**LF** = Solder flange with nut

\* not included in the article description

Male header	
 <b>Reflow solder connection</b>	 <b>Solder connection</b>



	1		2		1
	<b>S2C-SMT</b>	<b>S2C-SMT</b>	<b>S2CD-THR</b>	<b>S2L</b>	<b>S2L</b>
	90°	180°	90°	90°	180°
	G/LF	G/LF	G/LF	G/F	G/F
	IEC: 200 V/13.4 A UL: 150 V/10 A	IEC: 200 V/13.4 A UL: 150 V/10 A	IEC: 200 V/7.9 A UL: 150 V/7 A	IEC: 250 V/10 A UL: 150 V/10 A	IEC: 250 V/10 A UL: 150 V/10 A
	○	○	○	○	○
				○	○



## Double-row connectors in 3.50 mm pitch Series B2C/S2C 3.50

### B2CF/S2C and B2L/S2C 3.50 series

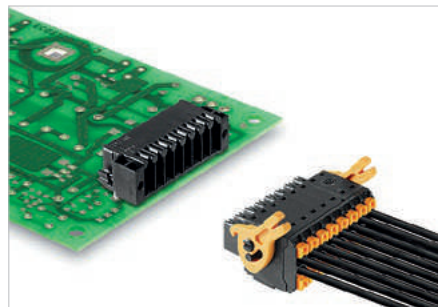

High-temperature-resistant, double-row male header

- Finger-safe
- Plugging direction parallel to PCB (recumbent / 90°)
- Housing variants: closed (G) and with solder flange (LF)
- Packed either in a box (BX) or tape-on-reel (RL)
- Suitable for reflow and wave soldering applications
- Pin length of either 1.5 mm or 3.2 mm
- Can be plugged into female plug B2CF 3.50/./180..

### Product data

IEC: 200 V / 13.4 A  
UL: 150 V / 10 A



For additional articles and information, refer to [catalog.weidmuller.com](http://catalog.weidmuller.com)

#### Note:

- Gold-plated contact surfaces on request
- Rated current related to rated cross-section & min. No. of poles.
- Spacing between rows: see hole layout
- P on drawing = pitch
- Rated data refer only to the component itself. Clearance and creepage distances to other components are to be designed in accordance with the relevant application standards.

### S2C-SMT 3.50/./90G Box

closed side



#### Dimensioned drawing

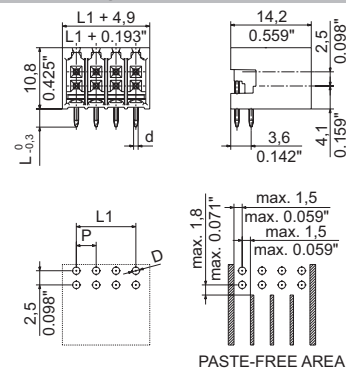

### Technical data

In compliance with IEC 60664-1 / IEC 61984			
Clamping range, max.			
<b>Solid core H05(07) V-U</b>			
Stranded H07 V-R			
Flexible H05(07) V-K			
Flexible with ferrule			
Ferrule with plastic collar			
Stripping length			
Screwdriver blade	mm		
According to norm			
Tightening torque range			
<b>Rated current, max.</b>		13.4	12
At ambient temperature		20°C	40°C
For conductor cross-section			
Overtoltage category		III	III II
Pollution severity		3	2 2
<b>Rated voltage</b>	V	80	160 200
Rated impulse voltage	kV	2.5	2.5 2.5
<b>UL / CUL (Use Group)</b>		B	C D
<b>Rated voltage</b>	V	150	50
<b>Rated current</b>	A	10	10
<b>AWG conductor</b>	AWG		-
<b>CSA (Use Group)</b>		B	C D
Rated voltage	V	150	50 150
Rated current	A	9.5	9.5 9.5
AWG conductor	AWG		-
<b>General data</b>			
Type of insulation material		LCP GF	
UL 94 flammability rating		V-0	
Contact base material		Copper alloy	
Material of contact surface		tinned	
Pin dimensions = d	mm	1.0, Octagonal	
Solder eyelet Ø = D	mm	1.3	
Solder eyelet Ø tolerance	mm	+ 0,1	

### Accessories

Note: Refer to the Accessories chapter for additional accessories.

Coding	Order No.
B2L/S2L 3.50 KO OR BX	1849730000
B2L/S2L 3.50 KO BK BX	1849740000
<b>LED light guide</b>	
S2L/S2C 3.5 FLA 20/10 SMD	1814590000

### Ordering data

Solder pin length		3.2 mm		
Colour		Black		
Pitch		3.50 mm		
Pol.	L1	(inch)	Qty.	Order No.
4	3.50	0.138	222	1288980000
6	7.00	0.276	156	1289270000
8	10.50	0.413	120	1289280000
10	14.00	0.551	96	1289290000
12	17.50	0.689	84	1289300000
14	21.00	0.827	72	1289310000
16	24.50	0.965	60	1289320000
18	28.00	1.102	54	1289330000
20	31.50	1.240	48	1289340000
22	35.00	1.378	42	1289350000
24	38.50	1.516	42	1289370000
26	42.00	1.654	36	1289380000
28	45.50	1.791	36	1289390000
30	49.00	1.929	30	1289410000
32	52.50	2.067	30	1289420000
34	56.00	2.205	30	1289430000
36	59.50	2.343	24	1289440000

**S2C-SMT 3.50/./90G Tape**

closed side; tape-on-reel



Dimensioned drawing

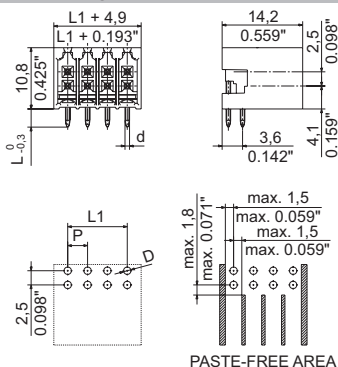

**Ordering data**

Solder pin length		1.5 mm	
Colour		Black	
Pitch		3.50 mm	
Pol.	L1	(inch)	Qty. Order No.
4	3.50	0.138	235 1359580000
6	7.00	0.276	235 1359590000
8	10.50	0.413	235 1359600000
10	14.00	0.551	235 1359610000
12	17.50	0.689	235 1359620000
14	21.00	0.827	235 1359630000
16	24.50	0.965	235 1359640000
18	28.00	1.102	235 1359650000
20	31.50	1.240	235 1359670000
22	35.00	1.378	235 1359680000
24	38.50	1.516	235 1359690000

Tape widths: 32, 44, 56, 72, 88

**S2C-SMT 3.50/./90LF Box**

with solder flange



Dimensioned drawing

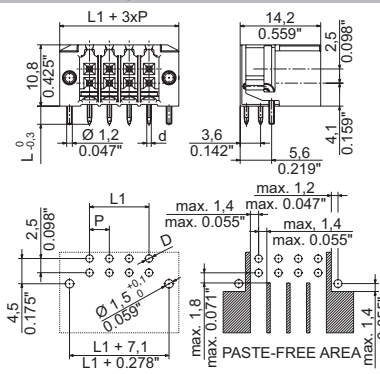

**Ordering data**

Solder pin length		3.2 mm	
Colour		Black	
Pitch		3.50 mm	
Pol.	L1	(inch)	Qty. Order No.
4	3.50	0.138	132 1289450000
6	7.00	0.276	102 1289460000
8	10.50	0.413	84 1289470000
10	14.00	0.551	72 1289480000
12	17.50	0.689	66 1289490000
14	21.00	0.827	54 1289500000
16	24.50	0.965	48 1289510000
18	28.00	1.102	48 1289520000
20	31.50	1.240	42 1289530000
22	35.00	1.378	36 1289540000
24	38.50	1.516	36 1289550000
26	42.00	1.654	30 1289570000
28	45.50	1.791	30 1289580000
30	49.00	1.929	30 1289590000
32	52.50	2.067	24 1289600000
34	56.00	2.205	24 1289610000
36	59.50	2.343	24 1289620000

**S2C-SMT 3.50/./90LF Tape**

with solder flange; tape-on-reel



Dimensioned drawing

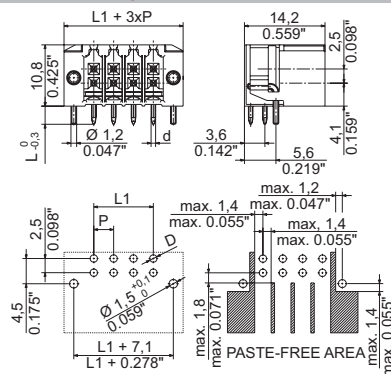

**Ordering data**

Solder pin length		1.5 mm	
Colour		Black	
Pitch		3.50 mm	
Pol.	L1	(inch)	Qty. Order No.
4	3.50	0.138	235 1359080000
6	7.00	0.276	235 1359090000
8	10.50	0.413	235 1359100000
10	14.00	0.551	235 1359120000
12	17.50	0.689	235 1359130000
14	21.00	0.827	235 1359140000
16	24.50	0.965	235 1359150000
18	28.00	1.102	235 1359160000
20	31.50	1.240	235 1359170000

Tape widths: 32, 44, 56, 72, 88

## Double-row connectors in 3.50 mm pitch Series B2C/S2C 3.50

### S2C-SMT 3.50../180

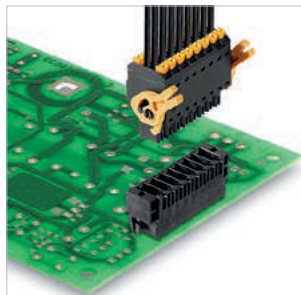

High-temperature-resistant, double-row male header

- Finger-safe
- Plugging direction vertical to PCB (standing / 180°)
- Housing variants: closed (G) and with solder flange (LF)
- Packed either in a box (BX) or tape-on-reel (RL)
- Suitable for reflow and wave soldering applications
- Pin length of either 1.5 mm or 3.2 mm
- Pluggable to female connector B2CF 3.50../180..

### Product data

IEC: 200 V / 13.4 A  
UL: 150 V / 10 A



For additional articles and information, refer to [catalog.weidmueller.com](http://catalog.weidmueller.com)

#### Note:

- Gold-plated contact surfaces on request
- Rated current related to rated cross-section & min. No. of poles.
- Spacing between rows: see hole layout
- P on drawing = pitch
- Rated data refer only to the component itself. Clearance and creepage distances to other components are to be designed in accordance with the relevant application standards.

### S2C-SMT 3.50../180G Box

closed side



#### Dimensioned drawing

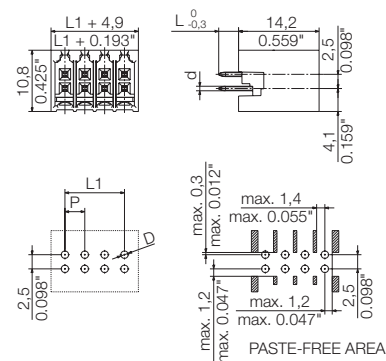

### Technical data

In compliance with IEC 60664-1 / IEC 61984

Clamping range, max.			
<b>Solid core H05(07) V-U</b>			
Stranded H07 V-R			
Flexible H05(07) V-K			
Flexible with ferrule			
Ferrule with plastic collar			
Stripping length			
Screwdriver blade	mm		
According to norm			
Tightening torque range			
<b>Rated current, max.</b>	<b>13.4</b>	<b>12</b>	
At ambient temperature	20°C	40°C	
For conductor cross-section			
Overtoltage category	III	III	II
Pollution severity	3	2	2
<b>Rated voltage</b>	<b>V</b>	<b>80</b>	<b>160</b>
Rated impulse voltage	kV	2.5	2.5
<b>UL / CUL (Use Group)</b>	<b>B</b>	<b>C</b>	<b>D</b>
<b>Rated voltage</b>	<b>V</b>	<b>150</b>	<b>50</b>
<b>Rated current</b>	<b>A</b>	<b>10</b>	<b>10</b>
<b>AWG conductor</b>	<b>AWG</b>	-	
<b>CSA (Use Group)</b>	<b>B</b>	<b>C</b>	<b>D</b>
Rated voltage	V	150	50
Rated current	A	9.5	9.5
AWG conductor	AWG	-	
<b>General data</b>			
Type of insulation material	LCP GF		
UL 94 flammability rating	V-0		
Contact base material	Copper alloy		
Material of contact surface	tinned		
Pin dimensions = d	mm	1.0, Octagonal	
Solder eyelet Ø = D	mm	1.3	
Solder eyelet Ø tolerance	mm	+ 0,1	

### Accessories

Note: Refer to the Accessories chapter for additional accessories.

Coding	Order No.
B2L/S2L 3.50 KO OR BX	1849730000
B2L/S2L 3.50 KO BK BX	1849740000

### Ordering data

Solder pin length		3.5 mm		
Colour		Black		
Pitch	3.50 mm			
Pol.	L1	(inch)	Qty.	Order No.
4	3.50	0.138	222	1290030000
6	7.00	0.276	156	1290040000
8	10.50	0.413	120	1290050000
10	14.00	0.551	96	1290060000
12	17.50	0.689	78	1290070000
14	21.00	0.827	72	1290080000
16	24.50	0.965	60	1290090000
18	28.00	1.102	54	1290110000
20	31.50	1.240	48	1290120000
22	35.00	1.378	42	1290130000
24	38.50	1.516	42	1290140000
26	42.00	1.654	36	1290150000
28	45.50	1.791	36	1290160000
30	49.00	1.929	30	1290170000
32	52.50	2.067	30	1290180000
34	56.00	2.205	30	1290190000
36	59.50	2.343	24	1290210000



**S2C-SMT 3.50/./180G Tape**

closed side; tape-on-reel



Dimensioned drawing

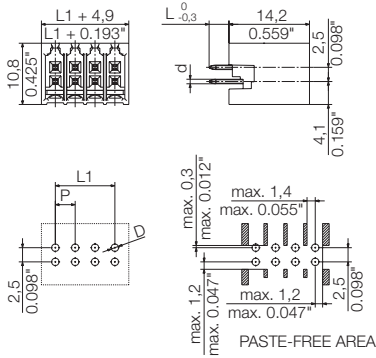

**Ordering data**

Solder pin length		1.5 mm	
Colour		Black	
Pitch		3.50 mm	
Pol.	L1	(inch)	Qty. Order No.
4	3.50	0.138	175 1358860000
6	7.00	0.276	175 1358870000
8	10.50	0.413	175 1358880000
10	14.00	0.551	175 1358890000
12	17.50	0.689	175 1358920000
14	21.00	0.827	175 1358940000
16	24.50	0.965	175 1358970000
18	28.00	1.102	175 1358990000
20	31.50	1.240	175 1359020000
22	35.00	1.378	175 1359040000
24	38.50	1.516	150 1359060000

**S2C-SMT 3.50/./180LF Box**

with solder flange



Dimensioned drawing

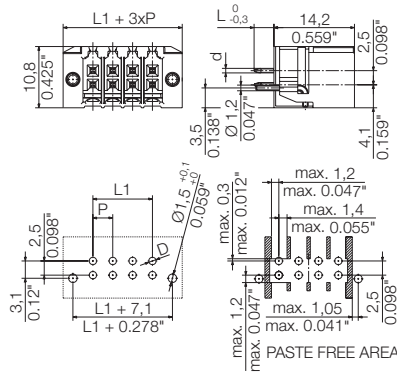

**Ordering data**

Solder pin length		3.5 mm	
Colour		Black	
Pitch		3.50 mm	
Pol.	L1	(inch)	Qty. Order No.
4	3.50	0.138	132 1290220000
6	7.00	0.276	102 1290230000
8	10.50	0.413	84 1290240000
10	14.00	0.551	72 1290250000
12	17.50	0.689	66 1290260000
14	21.00	0.827	54 1290270000
16	24.50	0.965	48 1290280000
18	28.00	1.102	48 1290290000
20	31.50	1.240	42 1290310000
22	35.00	1.378	36 1290320000
24	38.50	1.516	36 1290330000
26	42.00	1.654	30 1290340000
28	45.50	1.791	30 1290350000
30	49.00	1.929	30 1290360000
32	52.50	2.067	24 1290370000
34	56.00	2.205	24 1290380000
36	59.50	2.343	24 1290390000

**S2C-SMT 3.50/./180LF Tape**

with solder flange; tape-on-reel



Dimensioned drawing

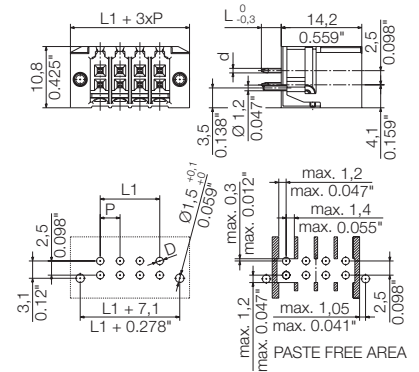

**Ordering data**

Solder pin length		1.5 mm	
Colour		Black	
Pitch		3.50 mm	
Pol.	L1	(inch)	Qty. Order No.
4	3.50	0.138	175 1358630000
6	7.00	0.276	175 1358640000
8	10.50	0.413	175 1358650000
10	14.00	0.551	175 1358670000
12	17.50	0.689	175 1358680000
14	21.00	0.827	175 1358690000
16	24.50	0.965	175 1358700000
18	28.00	1.102	175 1358710000
20	31.50	1.240	150 1358720000

Tape widths: 32, 44, 56, 72, 88

Tape widths: 32, 44, 56, 72, 88

## Double-row connectors in 3.50 mm pitch Series B2C/S2C 3.50

### S2CD-THR 3.50/./90

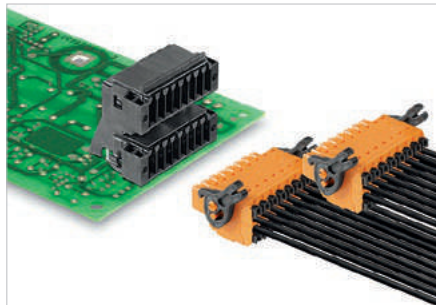

High contact density on a small surface: 75% space savings on the PCB. The only 4-row double-level male header for typical IP 20 sensor interfaces in 3.50 mm pitch.

- Finger-safe
- Plugging direction in parallel to circuit board (horizontal / 90°)
- Housing variants: closed (G) and with solder flange (LF)
- Packed in a cardboard box (BX)
- Suitable for reflow and wave soldering applications
- Pin length 3.2 mm
- Can be plugged into female plug B2CF 3.50/./180..

### Technical data

In compliance with IEC 60664-1 / IEC 61984

Clamping range, max.			
<b>Solid core H05(07) V-U</b>			
Stranded H07 V-R			
Flexible H05(07) V-K			
Flexible with ferrule			
Ferrule with plastic collar			
Stripping length			
Screwdriver blade	mm		
According to norm			
Tightening torque range			
<b>Rated current, max.</b>	<b>A</b>	<b>7.9</b>	<b>6.8</b>
At ambient temperature		20°C	40°C
For conductor cross-section			
Overtoltage category		III	III II
Pollution severity		3	2 2
<b>Rated voltage</b>	<b>V</b>	<b>100</b>	<b>160 200</b>
Rated impulse voltage	kV	1.5	2.5 2.5
<b>UL / CUL (Use Group)</b>	<b>B C D</b>		
<b>Rated voltage</b>	<b>V</b>	<b>150</b>	<b>50 50</b>
<b>Rated current</b>	<b>A</b>	<b>9.5</b>	<b>9.5 9.5</b>
<b>AWG conductor</b>	<b>AWG</b>	<b>-</b>	
<b>CSA (Use Group)</b>	<b>B C D</b>		
Rated voltage	V	50	50 150
Rated current	A	5	9.5 9.5
AWG conductor	AWG	-	
<b>General data</b>			
Type of insulation material	LCP GF		
UL 94 flammability rating	V-0		
Contact base material	Copper alloy		
Material of contact surface	tinned		
Pin dimensions = d	mm	1.0, Octagonal	
Solder eyelet Ø = D	mm	1.3	
Solder eyelet Ø tolerance	mm	+ 0,1	

### Product data

IEC: 200 V / 7.9 A  
UL: 150 V / 9.5 A



For additional articles and information, refer to [catalog.weidmueller.com](http://catalog.weidmueller.com)

#### Note:

- Gold-plated contact surfaces on request
- Rated current related to rated cross-section & min. No. of poles.
- Spacing between rows: see hole layout
- P on drawing = pitch
- Rated data refer only to the component itself. Clearance and creepage distances to other components are to be designed in accordance with the relevant application standards.

### S2CD-THR 3.50/./90G

closed side



### Dimensioned drawing

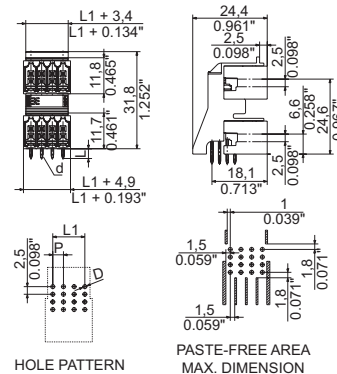

### Accessories

Note: Refer to the Accessories chapter for additional accessories.

Coding	Order No.
B2L/S2L 3.50 KO OR BX	1849730000
B2L/S2L 3.50 KO BK BX	1849740000

### Ordering data

Solder pin length		3.2 mm	
Colour		Black	
Pitch		3.50 mm	
Pol.	L1	(inch)	Qty. Order No.
8	10.50	0.413	50 1357790000
12	17.50	0.689	50 1357800000
16	24.50	0.413	20 1357820000
20	31.50	1.240	20 1357830000
24	38.50	1.516	20 1357840000
28	45.50	1.791	20 1357850000
32	52.50	2.067	20 1357870000
36	59.50	2.343	20 1357880000

1.5 mm solder pin length available on request

## S2CD-THR 3.50/././90LF

with solder flange



### Dimensioned drawing

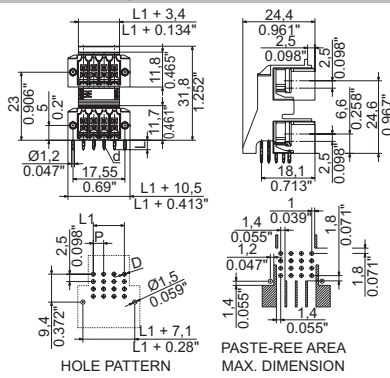

### Ordering data

Solder pin length		3.2 mm		
Colour		Black		
Pitch		3.50 mm		
Pol.	L1	(inch)	Qty.	Order No.
8	10.50	0.413	50	1357890000
12	17.50	0.689	50	1357900000
16	24.50	0.413	20	1357920000
20	31.50	1.240	20	1357930000
24	38.50	1.516	20	1357940000
28	45.50	1.791	20	1357950000
32	52.50	2.067	20	1357970000
36	59.50	2.343	20	1357990000

1.5 mm solder pin length available on request

## Double-row connectors in 3.50 mm pitch Series B2C/S2C 3.50

### B2CF 3.50/./180



Two-row female plug with "PUSH IN" spring connection.

- Simply insert the prepared wires - finished
- Intuitive handling - since the wire-entry area and handling area are clearly separated.
- Integrated push-buttons for opening the terminal point
- High component density because of low heights
- Optional: the lock and release requires no tools when using Weidmüller's patented (LR) release latch
- Approval according to IEC 60335 and GL in preparation
- Also compatible with series: S2L 3.50, S2L-SMT 3.50 and S2LD-THR 3.50

### Technical data

#### In compliance with IEC 60664-1 / IEC 61984

Clamping range, max.	mm <sup>2</sup>	0.14...1.5
<b>Solid core H05(07) V-U</b>	<b>mm<sup>2</sup></b>	<b>0.14...1.5</b>
Stranded H07 V-R		
Flexible H05(07) V-K	mm <sup>2</sup>	0.14...1.5
Flexible with ferrule	mm <sup>2</sup>	0.14...1.5
Ferrule with plastic collar	mm <sup>2</sup>	0.14...1
Stripping length	mm	10
Screwdriver blade	mm	0.4 x 2.5
According to norm		DIN 5264

Tightening torque range			
<b>Rated current, max.</b>	<b>A</b>	<b>13.4</b>	<b>12</b>
At ambient temperature		20°C	40°C

For conductor cross-section	mm <sup>2</sup>	1.5
Overvoltage category		III III II
Pollution severity		3 2 2

<b>Rated voltage</b>	<b>V</b>	<b>160</b>	<b>160</b>	<b>320</b>
Rated impulse voltage	kV	2.5	2.5	2.5

<b>UL / CUL (Use Group)</b>	<b>B</b>	<b>C</b>	<b>D</b>
-----------------------------	----------	----------	----------

<b>Rated voltage</b>	<b>V</b>	<b>300</b>	<b>50</b>	<b>300</b>
----------------------	----------	------------	-----------	------------

<b>Rated current</b>	<b>A</b>	<b>9.5</b>	<b>9.5</b>	<b>9.5</b>
----------------------	----------	------------	------------	------------

<b>AWG conductor</b>	<b>AWG</b>	<b>26-16</b>
----------------------	------------	--------------

<b>CSA (Use Group)</b>	<b>B</b>	<b>C</b>	<b>D</b>
------------------------	----------	----------	----------

Rated voltage	V	300	50	300
Rated current	A	9.5	9.5	9.5
AWG conductor	AWG	26-16		

#### General data

Type of insulation material		PA 66 GF 30
UL 94 flammability rating		V-0
Contact base material		Copper alloy
Material of contact surface		tinned
Pin dimensions = d	mm	
Solder eyelet Ø = D	mm	
Solder eyelet Ø tolerance	mm	

### Product data

IEC: 320 V / 13.4 A / 0.14 - 1.5 mm<sup>2</sup>  
UL: 300 V / 9.5 A / AWG 26 - 16



For additional articles and information, refer to [catalog.weidmueller.com](http://catalog.weidmueller.com)

#### Note:

- Additional colours on request
  - Gold-plated contact surfaces on request
  - Rated current related to rated cross-section & min. No. of poles.
  - Crimp shape A for wire-end ferrules with crimping tools PZ 1,5 (order no. 9005990000) or PZ 6/5 (order no. 9011460000) for larger wire cross-sections recommended.
  - P on drawing = pitch
  - Rated data refer only to the component itself. Clearance and creepage distances to other components are to be designed in accordance with the relevant application standards.
  - Max. outer diameter of the conductor 2.6 mm
- Wire-end ferrule w/plastic collar DIN 46228/4 or Weidmüller colour code
- 1.00mm<sup>2</sup> [H1.0/18D] mtl. ferrule leng. 12mm, stripping leng. 15mm
  - 0.75mm<sup>2</sup> [H0.75/18D] mtl. ferrule leng. 12mm, stripping leng. 14mm
  - 0.50mm<sup>2</sup> [H0.5/16D] mtl. ferrule leng. 10mm, stripping leng. 12mm
  - 0.34mm<sup>2</sup> [H0.34/12] mtl. ferrule leng. 8mm, stripping leng. 10mm
  - 0.25mm<sup>2</sup> [H0.25/12] mtl. ferrule leng. 8mm, stripping leng. 10mm
  - 0.14mm<sup>2</sup> [H0.14/12] mtl. ferrule leng. 8mm, stripping leng. 10mm
- Wire-end ferrule w/o plastic collar acc. to DIN 46228/1
- 1.50mm<sup>2</sup> [H1.5/10] mtl. ferrule leng. 10mm, stripping leng. 10mm
- Wire-end ferrule w/plastic collar DIN 46228/4 and 2 connec. cables
- 2 x 0.20mm<sup>2</sup> [H0.5/16] mtl. ferrule leng. 10mm, stripping leng. 12mm
  - 2 x 0.34mm<sup>2</sup> [H1.0/18] mtl. ferrule leng. 12mm, stripping leng. 15mm

### Accessories

Note: Refer to the Accessories chapter for additional accessories.

Coding	Order No.
B2L/S2L 3.50 KO OR BX	1849730000
B2L/S2L 3.50 KO BK BX	1849740000

Strain relief	Order No.
BL 3.50 ZE03 OR BX	1629680000
BL 3.50 ZE03 BK BX	1627820000
BL 3.50 ZE08 OR BX	1629690000

Screwdriver	Order No.
SDS 0.4X2.5X75	9009030000

Crimping tool	Order No.
PZ 1.5	9005990000
PZ 6/5	9011460000

### B2CF 3.50/./180



#### Dimensioned drawing

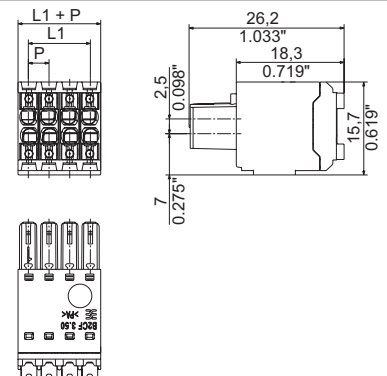

### Ordering data

Solder pin length		Orange		
Colour	Pitch	3.50 mm	Qty.	Order No.
Pol.	L1	(inch)		
4	3.50	0.138	264	1277270000
6	7.00	0.276	174	1277280000
8	10.50	0.413	132	1277290000
10	14.00	0.551	102	1277310000
12	17.50	0.689	84	1277320000
14	21.00	0.827	72	1277330000
16	24.50	0.965	66	1277340000
18	28.00	1.102	54	1277350000
20	31.50	1.240	48	1277360000
22	35.00	1.378	48	1277370000
24	38.50	1.516	42	1277380000
26	42.00	1.654	36	1277390000
28	45.50	1.791	36	1277410000
30	49.00	1.929	30	1277420000
32	52.50	2.067	30	1277430000
34	56.00	2.205	30	1277440000
36	59.50	2.343	24	1277450000

### Representative deratings curve

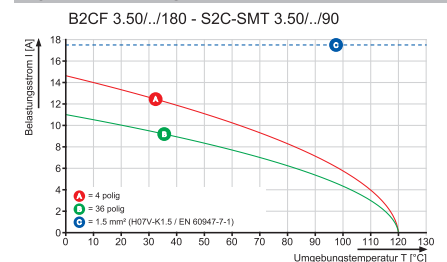

### B2CF 3.50/./180F

with screw flange



Dimensioned drawing

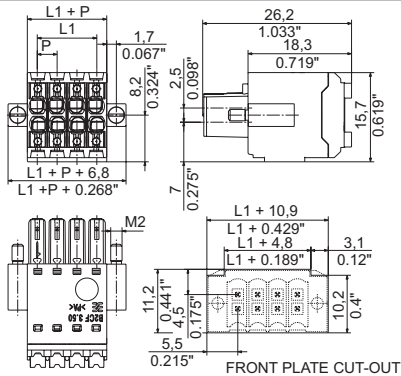

#### Ordering data

Solder pin length					
Colour		Orange			
Pitch	3.50 mm				
Pol.	L1	(inch)	Qty.	Order No.	
4	3.50	0.138	120	1277650000	
6	7.00	0.276	102	1277670000	
8	10.50	0.413	84	1277680000	
10	14.00	0.551	72	1277690000	
12	17.50	0.689	66	1277720000	
14	21.00	0.827	54	1277730000	
16	24.50	0.965	48	1277740000	
18	28.00	1.102	48	1277750000	
20	31.50	1.240	42	1277760000	
22	35.00	1.378	36	1277770000	
24	38.50	1.516	36	1277780000	
26	42.00	1.654	30	1277790000	
28	45.50	1.791	30	1277810000	
30	49.00	1.929	30	1277820000	
32	52.50	2.067	24	1277830000	
34	56.00	2.205	24	1277840000	
36	59.50	2.343	24	1277850000	

### B2CF 3.50/./180LR

with release latch



Dimensioned drawing

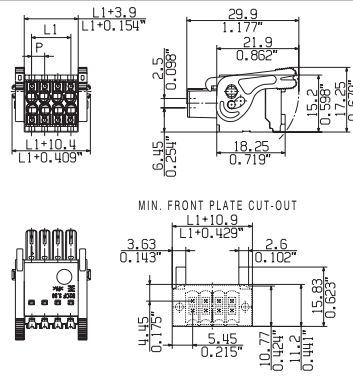

#### Ordering data

Solder pin length					
Colour		Orange			
Pitch	3.50 mm				
Pol.	L1	(inch)	Qty.	Order No.	
4	3.50	0.138	138	1278040000	
6	7.00	0.276	108	1278050000	
8	10.50	0.413	90	1278060000	
10	14.00	0.551	78	1278070000	
12	17.50	0.689	66	1278080000	
14	21.00	0.827	60	1278090000	
16	24.50	0.965	54	1278100000	
18	28.00	1.102	48	1278110000	
20	31.50	1.240	42	1278120000	
22	35.00	1.378	42	1278130000	
24	38.50	1.516	36	1278140000	
26	42.00	1.654	36	1278150000	
28	45.50	1.791	30	1278170000	
30	49.00	1.929	30	1278180000	
32	52.50	2.067	30	1278190000	
34	56.00	2.205	24	1278200000	
36	59.50	2.343	24	1278210000	

Release lever (LH) see Online catalogue

## Double-row connectors in 3.50 mm pitch Series B2L/S2L 3.50

### S2L 3.50/././90

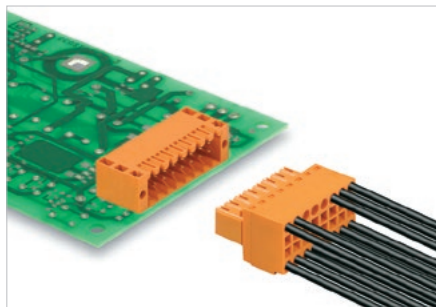

Angled, double-row male header. Male headers with 3.5 mm pins that are designed for wave soldering and are packaged in a box. Available in closed (G) version and with screw flange (F).

### Product data

IEC: 250 V / 10 A  
UL: 150 V / 10 A



For additional articles and information, refer to [catalog.weidmuller.com](http://catalog.weidmuller.com)

#### Note:

- Additional colours on request
- Gold-plated contact surfaces on request
- Spacing between rows: see hole layout
- Rated current related to rated cross-section & min. No. of poles.
- P on drawing = pitch
- Rated data refer only to the component itself. Clearance and creepage distances to other components are to be designed in accordance with the relevant application standards.

### S2L 3.50/././90G

closed ends



#### Dimensioned drawing

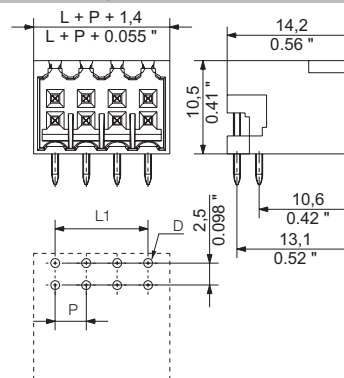

### Technical data

#### In compliance with IEC 60664-1 / IEC 61984

Clamping range, max.			
<b>Solid core H05(07) V-U</b>			
Stranded H07 V-R			
Flexible H05(07) V-K			
Flexible with ferrule			
Ferrule with plastic collar			
Stripping length			
Screwdriver blade	mm		
According to norm			
Tightening torque range			
<b>Rated current, max.</b>	<b>A</b>	<b>10</b>	<b>9</b>
At ambient temperature		20°C	40°C
For conductor cross-section			
Overvoltage category		III	III II
Pollution severity		3	2 2
<b>Rated voltage</b>	<b>V</b>	<b>80</b>	<b>125 250</b>
Rated impulse voltage	kV	2.5	2.5 2.5
<b>UL / CUL (Use Group)</b>	<b>B C D</b>		
<b>Rated voltage</b>	<b>V</b>	<b>150</b>	<b>50</b>
<b>Rated current</b>	<b>A</b>	<b>10</b>	<b>10</b>
<b>AWG conductor</b>	<b>AWG</b>	<b>-</b>	
<b>CSA (Use Group)</b>	<b>B C D</b>		
Rated voltage	V	150	
Rated current	A	5	
AWG conductor	AWG	-	
<b>General data</b>			
Type of insulation material	PBT		
UL 94 flammability rating	V-0		
Contact base material	Copper alloy		
Material of contact surface	tinned		
Pin dimensions = d	mm	1.0, Octagonal	
Solder eyelet Ø = D	mm	1.3	
Solder eyelet Ø tolerance	mm	+ 0,1	

### Accessories

Note: Refer to the Accessories chapter for additional accessories.

Coding	Order No.
B2L/S2L 3.50 KO OR BX	<b>1849730000</b>
B2L/S2L 3.50 KO BK BX	<b>1849740000</b>
<b>LED light guide</b>	
S2L/S2C 3.5 FLA 20/10	<b>1699580000</b>
<b>Mounting screw</b>	
PTSC KA 2.2X4.5 WN1412	<b>1610740000</b>

### Ordering data

Solder pin length		3.5 mm		
Colour	Orange			
Pitch	3.50 mm			
Pol.	L1	(inch)	Qty.	Order No.
6	7.00	0.276	156	<b>1727830000</b>
8	10.50	0.413	120	<b>1727840000</b>
10	14.00	0.551	96	<b>1727850000</b>
12	17.50	0.689	78	<b>1727860000</b>
14	21.00	0.827	72	<b>1727870000</b>
16	24.50	0.965	60	<b>1727880000</b>
18	28.00	1.102	54	<b>1727890000</b>
20	31.50	1.240	48	<b>1727900000</b>
22	35.00	1.378	42	<b>1727910000</b>
24	38.50	1.516	42	<b>1727920000</b>
26	42.00	1.654	36	<b>1727930000</b>
28	45.50	1.791	36	<b>1727940000</b>
30	49.00	1.929	30	<b>1727950000</b>
32	52.50	2.067	30	<b>1727960000</b>
34	56.00	2.205	30	<b>1727970000</b>
36	59.50	2.343	24	<b>1727980000</b>

For open version, see online catalogue

**S2L 3.50/./90F**

with screw flange



**Dimensioned drawing**

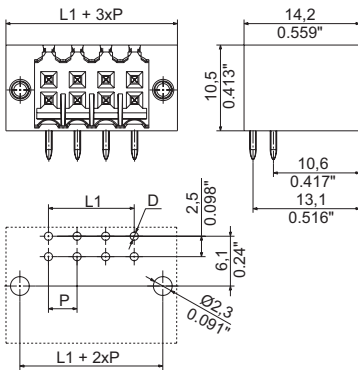

**Ordering data**

<b>Solder pin length</b>		<b>3.5 mm</b>		
<b>Colour</b>		<b>Orange</b>		
<b>Pitch</b>		<b>3.50 mm</b>		
Pol.	L1	(inch)	Qty.	Order No.
6	7.00	0.276	102	1728470000
8	10.50	0.413	84	1728480000
10	14.00	0.551	72	1728490000
12	17.50	0.689	66	1728500000
14	21.00	0.827	54	1728510000
16	24.50	0.965	48	1728520000
18	28.00	1.102	48	1728530000
20	31.50	1.240	42	1728540000
22	35.00	1.378	36	1728550000
24	38.50	1.516	36	1728560000
26	42.00	1.654	30	1728570000
28	45.50	1.791	30	1728580000
30	49.00	1.929	30	1728590000
32	52.50	2.067	24	1728600000
34	56.00	2.205	24	1728610000
36	59.50	2.343	24	1728620000

For open version, see online catalogue



## Double-row connectors in 3.50 mm pitch Series B2L/S2L 3.50

### S2L 3.50/././180

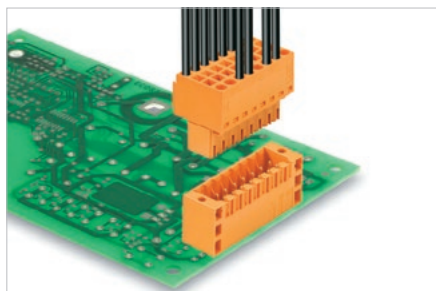

Straight, double-row male header. Male headers with 3.5 mm pins that are designed for wave soldering and are packaged in a box. The flange version can be screwed on the PCB. The male headers provide space for labelling and can be coded. Available in closed (G) version and with screw flange (LF).

### Product data

IEC: 250 V / 10 A  
UL: 150 V / 10 A



For additional articles and information, refer to [catalog.weidmuller.com](http://catalog.weidmuller.com)

#### Note:

- Additional colours on request
- Gold-plated contact surfaces on request
- Spacing between rows: see hole layout
- Rated current related to rated cross-section & min. No. of poles.
- P on drawing = pitch
- Rated data refer only to the component itself. Clearance and creepage distances to other components are to be designed in accordance with the relevant application standards.

### S2L 3.50/././180G

closed ends



#### Dimensioned drawing

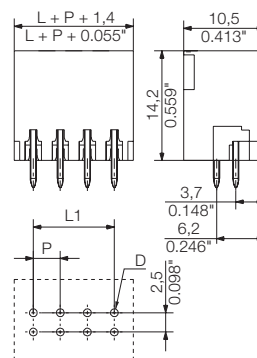

### Technical data

#### In compliance with IEC 60664-1 / IEC 61984

Clamping range, max.			
<b>Solid core H05(07) V-U</b>			
Stranded H07 V-R			
Flexible H05(07) V-K			
Flexible with ferrule			
Ferrule with plastic collar			
Stripping length			
Screwdriver blade	mm		
According to norm			
Tightening torque range			
<b>Rated current, max.</b>	<b>A</b>	<b>10</b>	<b>9</b>
At ambient temperature		20°C	40°C
For conductor cross-section			
Overtoltage category		III	III II
Pollution severity		3	2 2
<b>Rated voltage</b>	<b>V</b>	<b>80</b>	<b>125 250</b>
Rated impulse voltage	kV	2.5	2.5 2.5
<b>UL / CUL (Use Group)</b>	<b>B C D</b>		
<b>Rated voltage</b>	<b>V</b>	<b>150</b>	<b>50</b>
<b>Rated current</b>	<b>A</b>	<b>10</b>	<b>10</b>
<b>AWG conductor</b>	<b>AWG</b>	<b>-</b>	
<b>CSA (Use Group)</b>	<b>B C D</b>		
Rated voltage	V	150	
Rated current	A	5	
AWG conductor	AWG	-	
<b>General data</b>			
Type of insulation material	PBT		
UL 94 flammability rating	V-0		
Contact base material	Copper alloy		
Material of contact surface	tinned		
Pin dimensions = d	mm	1.0, Octagonal	
Solder eyelet Ø = D	mm	1.3	
Solder eyelet Ø tolerance	mm	+ 0,1	

### Accessories

Note: Refer to the Accessories chapter for additional accessories.

Coding	Order No.
B2L/S2L 3.50 KO OR BX	<b>1849730000</b>
B2L/S2L 3.50 KO BK BX	<b>1849740000</b>
Mounting screw	
PTSC KA 2.2X4.5 WN1412	<b>1610740000</b>

### Ordering data

Solder pin length		3.5 mm		
Colour	Orange			
Pitch	3.50 mm			
Pol.	L1	(inch)	Qty.	Order No.
6	7.00	0.276	156	<b>1728790000</b>
8	10.50	0.413	120	<b>1728800000</b>
10	14.00	0.551	96	<b>1728810000</b>
12	17.50	0.689	78	<b>1728820000</b>
14	21.00	0.827	72	<b>1728830000</b>
16	24.50	0.965	60	<b>1728840000</b>
18	28.00	1.102	54	<b>1728850000</b>
20	31.50	1.240	48	<b>1728860000</b>
22	35.00	1.378	42	<b>1728870000</b>
24	38.50	1.516	42	<b>1728880000</b>
26	42.00	1.654	36	<b>1728890000</b>
28	45.50	1.791	36	<b>1728900000</b>
30	49.00	1.929	30	<b>1728910000</b>
32	52.50	2.067	30	<b>1728920000</b>

For open version, see online catalogue



**S2L 3.50/././180F**

with screw flange



Dimensioned drawing

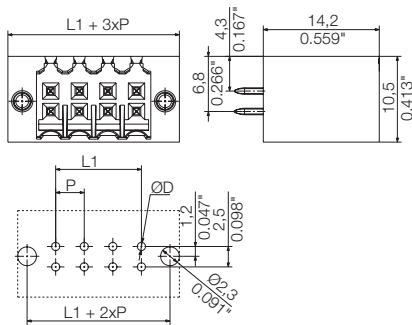

**Ordering data**

Solder pin length		3.5 mm		
Colour		Orange		
<b>Pitch</b>		<b>3.50 mm</b>		
Pol.	L1	(inch)	Qty.	Order No.
6	7.00	0.276	102	1729430000
8	10.50	0.413	84	1729440000
10	14.00	0.551	72	1729450000
12	17.50	0.689	66	1729460000
14	21.00	0.827	54	1729470000
16	24.50	0.965	48	1729480000
18	28.00	1.102	48	1729490000
20	31.50	1.240	42	1729500000
22	35.00	1.378	36	1729510000
24	38.50	1.516	36	1729520000
26	42.00	1.654	30	1729530000
28	45.50	1.791	30	1729540000
30	49.00	1.929	30	1729550000
32	52.50	2.067	24	1729560000
34	56.00	2.205	24	1729570000
36	59.50	2.343	24	1729580000

For open version, see online catalogue

## Double-row connectors in 3.50 mm pitch Series B2L/S2L 3.50

### B2L 3.50/./180 QV

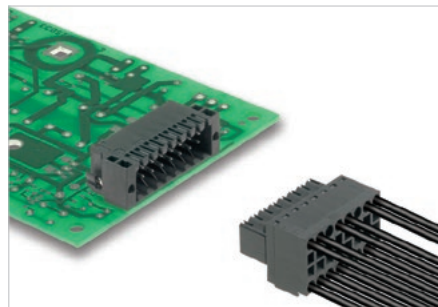

Female plugs with integral cross-connection.

- Cross-connection is positioned vertically between the poles of rows directly on top of each other.
- Tension clamp connection with straight outlet and 3.5 mm pitch.
- Flange (F) and release lever (LH) available.

### Product data

IEC: 200 V / 10.6 A / 0.2 - 1 mm<sup>2</sup>  
UL: 150 V / 7 A / AWG 28 - 18



For additional articles and information, refer to [catalog.weidmuller.com](http://catalog.weidmuller.com)

#### Note:

- Additional colours on request
- Gold-plated contact surfaces on request
- Rated current related to rated cross-section & min. No. of poles.
- Wire end ferrule with plastic collar to DIN 46228/4
- Wire end ferrule without plastic collar to DIN 46228/1
- P on drawing = pitch
- We recommend crimp shape A for wire-end ferrules with crimping tool PZ 6/5 (order no. 9011460000) for the larger wire cross-sections.
- Rated data refer only to the component itself. Clearance and creepage distances to other components are to be designed in accordance with the relevant application standards.

### B2L 3.50/./180QV

with cross-connection



#### Dimensioned drawing

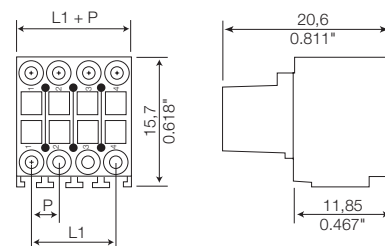

### Technical data

In compliance with IEC 60664-1 / IEC 61984			
Clamping range, max.	mm <sup>2</sup>	0.08...1	
<b>Solid core H05(07) V-U</b>	mm <sup>2</sup>	<b>0.2...1</b>	
Stranded H07 V-R			
Flexible H05(07) V-K	mm <sup>2</sup>	0.2...1	
Flexible with ferrule	mm <sup>2</sup>	0.14...0.34	
Ferrule with plastic collar	mm <sup>2</sup>	0.14...0.34	
Stripping length	mm	7	
Screwdriver blade	mm	0.4 x 2.5	
According to norm		DIN 5264	
Tightening torque range			
<b>Rated current, max.</b>	<b>A</b>	<b>10.6</b>	<b>9.1</b>
At ambient temperature		20°C	40°C
For conductor cross-section	mm <sup>2</sup>	1	
Overvoltage category		III	III II
Pollution severity		3	2 2
<b>Rated voltage</b>	<b>V</b>	<b>80</b>	<b>160</b> <b>200</b>
Rated impulse voltage	kV	1.5	2.5 2.5
<b>UL / CUL (Use Group)</b>		<b>B</b>	<b>C</b> <b>D</b>
<b>Rated voltage</b>	<b>V</b>	<b>150</b>	<b>50</b>
<b>Rated current</b>	<b>A</b>	<b>7</b>	<b>7</b>
<b>AWG conductor</b>	<b>AWG</b>	<b>28-18</b>	
<b>CSA (Use Group)</b>		<b>B</b>	<b>C</b> <b>D</b>
Rated voltage	V	300	
Rated current	A	7	
AWG conductor	AWG	28-18	
<b>General data</b>			
Type of insulation material		PBT	
UL 94 flammability rating		V-0	
Contact base material		Copper alloy	
Material of contact surface		tinned	
Pin dimensions = d	mm		
Solder eyelet Ø = D	mm		
Solder eyelet Ø tolerance	mm		

### Accessories

Note: Refer to the Accessories chapter for additional accessories.

Coding	Order No.
B2L/S2L 3.50 KO OR BX	1849730000
B2L/S2L 3.50 KO BK BX	1849740000
<b>Cover hood</b>	
B2L 3.50 AH06 BK BX	1781560000
B2L 3.50 AH08 BK BX	1781570000
B2L 3.50 AH10 BK BX	1781580000
B2L 3.50 AH12 BK BX	1781590000
B2L 3.50 AH14 BK BX	1781600000
B2L 3.50 AH16 BK BX	1781610000
B2L 3.50 AH18 BK BX	1781620000
B2L 3.50 AH20 BK BX	1781630000
B2L 3.50 AH22 BK BX	1781640000
B2L 3.50 AH24 BK BX	1781650000
B2L 3.50 AH26 BK BX	1781660000
B2L 3.50 AH28 BK BX	1781670000
B2L 3.50 AH30 BK BX	1781680000
B2L 3.50 AH32 BK BX	1781690000
B2L 3.50 AH34 BK BX	1781700000
B2L 3.50 AH36 BK BX	1781710000
<b>Screwdriver</b>	
SDS 0.4X2.5X75	9009030000
<b>Crimping tool</b>	
PZ 6/5	9011460000
PZ 1.5	9005990000

### Ordering data

Solder pin length				
Colour	Black			
Pitch	3.50 mm			
Pol.	L1	(inch)	Qty.	Order No.
6	7.00	0.276	174	1944590000
8	10.50	0.413	132	1944600000
10	14.00	0.551	102	1944610000
12	17.50	0.689	84	1944620000
14	21.00	0.827	72	1944630000
16	24.50	0.965	66	1944640000
18	28.00	1.102	54	1944650000

### Representative deratings curve

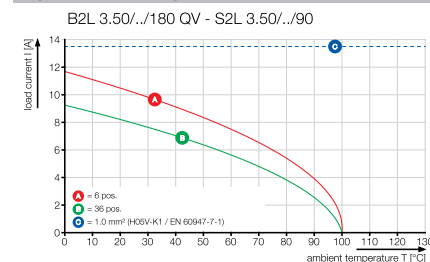

### B2L 3.50/./180FQV

with cross-connection and flange



Dimensioned drawing

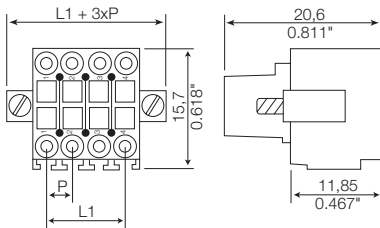

### B2L 3.50/./180LHQV

with cross-connection and release lever



Dimensioned drawing

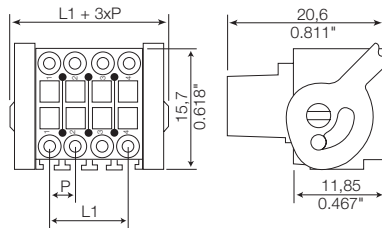

#### Ordering data

Solder pin length					
Colour					Black
Pitch 3.50 mm					
Pol.	L1	(inch)	Qty.	Order No.	
6	7.00	0.276	108	1944670000	
8	10.50	0.413	90	1944680000	
10	14.00	0.551	72	1944690000	
12	17.50	0.689	66	1944700000	
14	21.00	0.827	20	1944710000	
16	24.50	0.965	54	1944720000	
18	28.00	1.102	48	1944730000	

#### Ordering data

Solder pin length					
Colour					Black
Pitch 3.50 mm					
Pol.	L1	(inch)	Qty.	Order No.	
6	7.00	0.276	108	1944750000	
8	10.50	0.413	90	1944760000	
10	14.00	0.551	72	1944770000	
12	17.50	0.689	66	1944780000	
14	21.00	0.827	20	1944790000	
16	24.50	0.965	54	1944800000	
18	28.00	1.102	48	1944810000	

## Excellent design & performance: the single row BL/SL Connector system with 3.50 pitch and the connection of I/Os

Extensive range of male headers and female plugs that cover different angles to the PCB and conductor angle to the field as well as a large range of accessories make the 3.50 mm pitch very versatile.

### Strong in performance and connections, compact in its size:

- Wire cross-sections from 0.20 to 1.5 mm<sup>2</sup> (AWG 28-14)
- Wire connection without special tools
- More than just extra-low voltages: up to 250 V (IEC) / 300 V (UL)
- More than enough: up to 17 A (IEC) / 10 A (UL)

E

### Reliable connection technology

Decide on the best connection technology such as the service-free standard: Weidmüller clamping yoke connection with 100 % reliability and 100 % work output: steel for strength and copper for current.

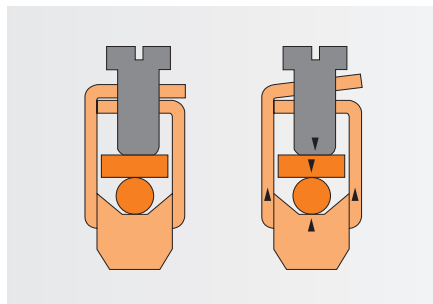

**Maximum packing density**

Either in a device using double layer male headers SLD or in the field using a 3 row socket connector BL-I/O.

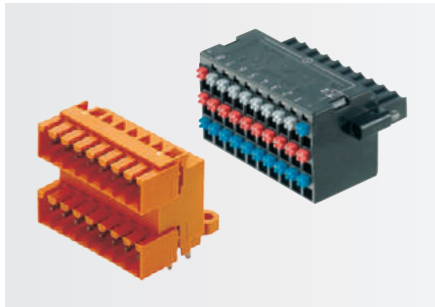

**Advanced application possibilities**

The extensive range of accessories increases the versatility and permits any desired combination of male headers and female plugs.



**Versatile field connection**

Choose your individual connection from the classic screw connection BL, the future-proof PUSH IN connection BL-I/O, the proven tension-clamp system BLZF or the quick connection BLIDCB.

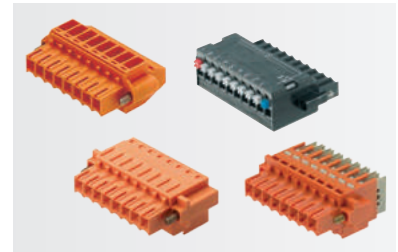

**Optimum processing**

The tape-on-reel packaging for high temperature-resistant male headers made of LCP guarantees a suitable product for automated processing. The integrated solder flange significantly increases the PCB's stability and replaces the screw that would normally be added later.

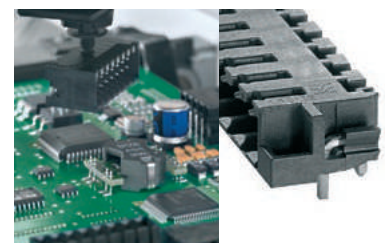

**Release latch or screw flange**

The release latch guarantees a good connection between the female plug and the device and also, particularly for systems with many pins, ensures an assembly protecting release of the connection. The screw flange creates a vibration and shake-proof connection between the panel connection and the device.

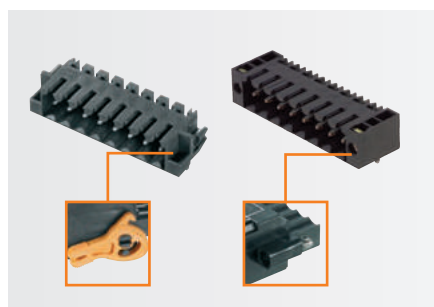

## Efficient connections on smallest footprint BLF 3.5 PUSH IN connector in 3.50 mm pitch

Increasingly complex control systems are required in industrial automation technology. In addition, the cost pressure and the requirements for plant safety are rising. The PUSH IN connector BLF 3.5 sets new standards in order to meet these challenges optimally.

The particularly flat and compact BLF 3.5 has been developed especially for industrial automation technology. Its PUSH IN connection technology, equipped with functional release and locking levers, is suitable for conductor cross sections up to 1.5 mm<sup>2</sup> and supports a fast and reliable handling during installation and maintenance. A safety rib prevents accidentally pushing the lever when plugging.

E



### Variable fixing options

The connector has two mounting flanges allowing for two fixing-options. One is via a Lock & Release Lever, and the other is conventional with a screw.



**Pluggable cross connection**

With the standard accessory ZQV 1.5N/  
R3.5/2-4, pluggable cross connections can be  
established with up to four poles.

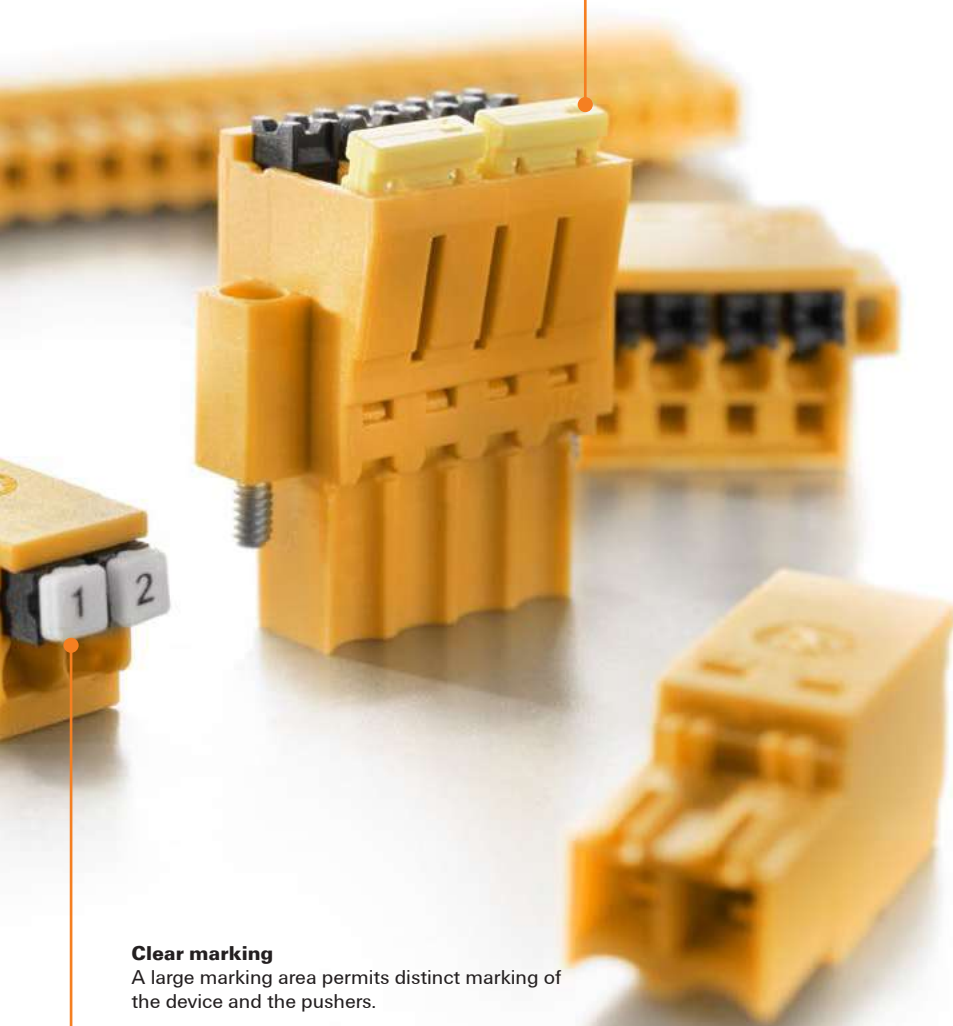
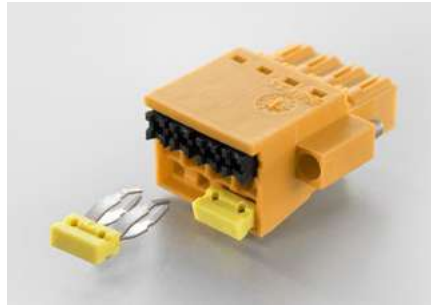
**Clear marking**

A large marking area permits distinct marking of  
the device and the pushers.

**Your special advantages**

- PUSH IN connectors for conductor cross sections up to 1.5 mm<sup>2</sup>
- High component density thanks to compact design
- Highly visible marking field for labelling
- Integrated mounting flanges
- Strain relief to fix and pull out the wire
- Pluggable cross connection optional



**Webcode: #11410**

## Small – smaller – BL-I/O: minimal size – maximum functionality

You have a free choice for the field wiring: whether you prefer the compact version with our 3 row female plug BL-I/O 3.50/30-poles or rather conventional systems with terminals or interface modules lowercase's. Since the female plug BL-I/O 3.50 based I/O systems are backwards compatible with existing field connections.

The female plug BL-I/O 3.50 mm pitch is an

- extremely compact,
- 1 or 3 row female plug, suitable for connection of remote sensors and/or actuators
- with integrated LED display
- and integrated cross-connections for potential distribution.

For efficient remote functional units in the field level the female plug BL-I/O 3.50 is a space saving solution to connect I/O components.

Savings from the female connector BL-I/O are apparent in the development and the manufacturing of the PCB. The layout is simplified by 62 % and fewer layers are required.

### Multiply your potential

Special cross-connectors, that are integrated into the second and third rows of the female plug, distribute the supply voltage to the individual I/O channels. In this way you can input, transfer or bridge the supply voltage. Thus you can save space with the I/O electronics, and you can reduce your wiring overhead.

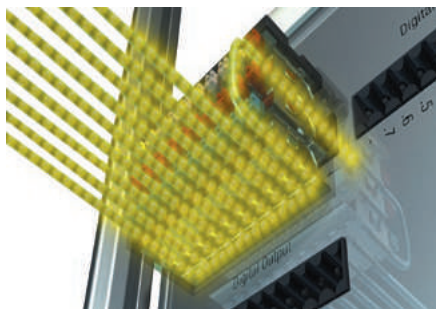

### ... as simple as that

Simply insert solid or flexible conductors with ferrules. The simple pressing of one button opens the terminal connections and allows you to insert the flexible wire without ferrules in no time at all. Disconnecting the wire is just as easy: press the button and pull out the wire.

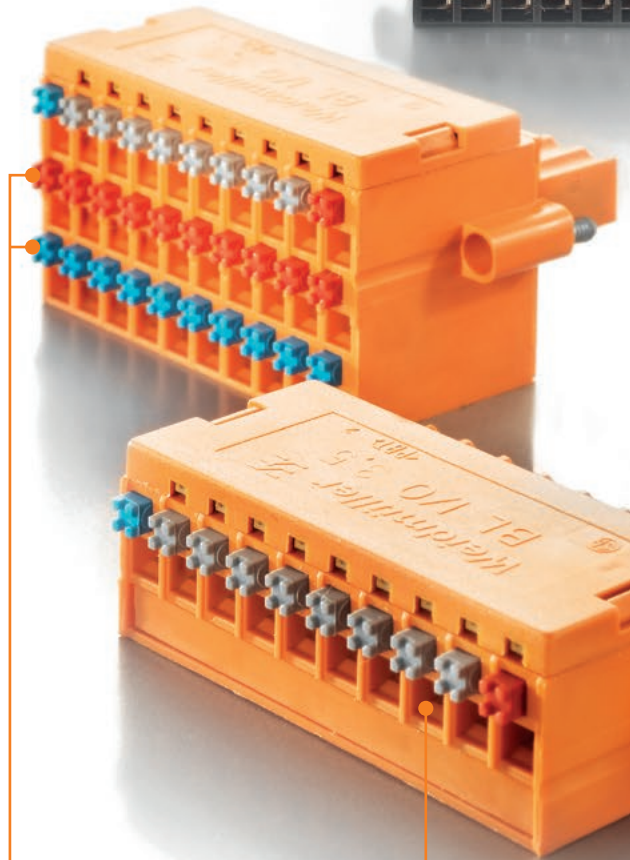
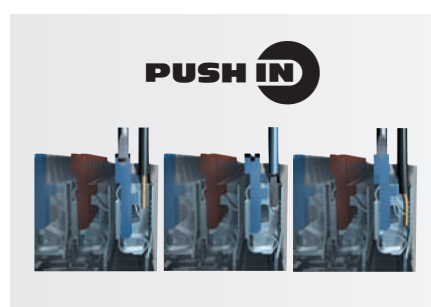



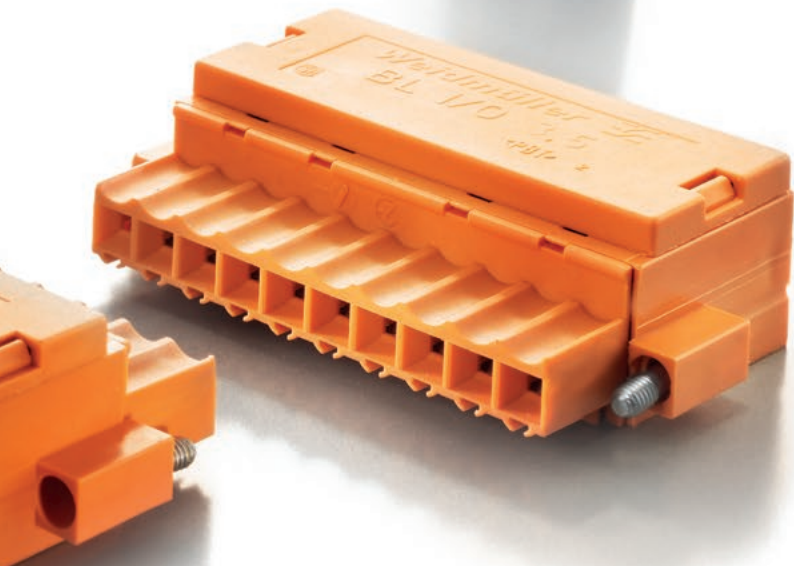
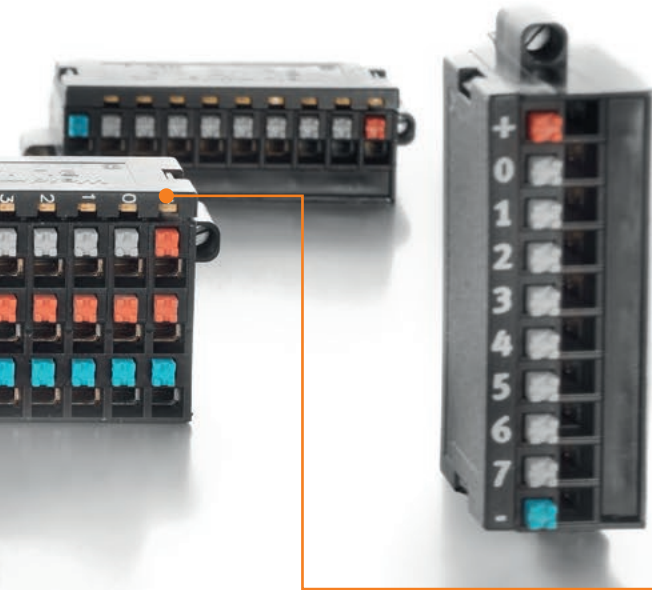

**Integrated LEDs**

Since power is supplied directly through the female plug BL-I/O 3.50, functional control of the sensor wiring is possible without any additionally connected I/O electronics. That simplifies initial commissioning and also clears up space on the control unit.

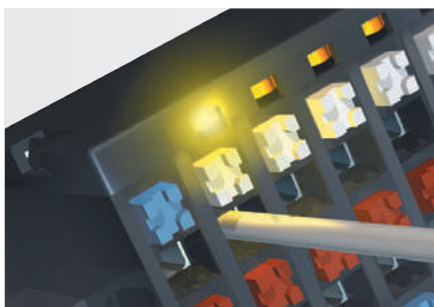

**Intuitive locking and releasing**

The 3 row female plug BL-I/O 3.50/30/180LR with lock & release lever to allow tool free interlocking and electronic assembly protecting release with the new male header SL-SMT 3.50/10/...RF with clip-on flange

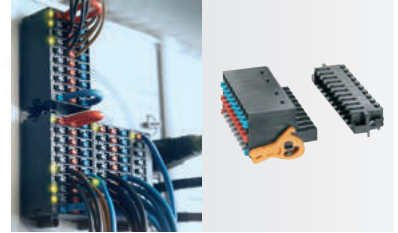

**Rugged screw flange**

The 3 row female plug BL-I/O 3-5/30/180F with screw flange for vibration and shock resistant interlocking in conjunction with the male header SL-SMT 3.50/10/...LF with solder flange.

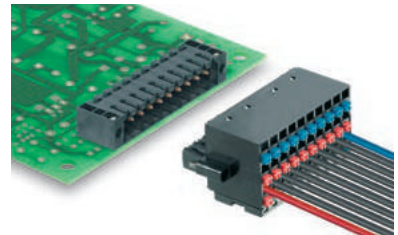

**Screwless PCB fastening - suitable for automatic assembly**

The male header SL-SMT has a clip-on flange for the release latch and is available as solder flange variant for the screw flange. In both variants the extra solder pin replaces the screw that would have to be added later and significantly increases the mechanical stability to the PCB.



# The industrial PUSH IN smart connection

## BL I/O 3.5 CJC connectors with integrated cold junction compensation

Many industrial applications demand increasingly higher accuracy of temperature measurement. At the same time, the required equipment must become cheaper and smaller. For the BL I/O 3.5 CJC, the cold junction compensation is integrated into the connector, which reduces space and costs.

The cold junction compensation of the BL I/O CJC is integrated by a thermistor in the connector. Therefore, no additional compensation is needed when connecting thermocouples to a device to measure the temperature. The integrated compensation simplifies the device and increases the measuring accuracy up to 20 %.

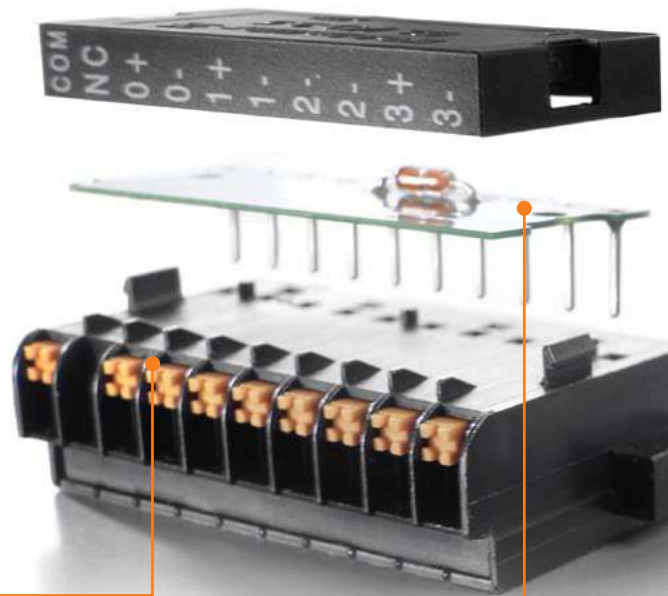

### PUSH IN connection up to 1.5 mm<sup>2</sup>

With the PUSH IN connection technology, the conductor connection becomes tool-free. Solid conductors or flexible conductors with wire end ferrules are easily inserted.



### Integrated thermistor

Cold junction compensation by integrated thermistor, to have a higher precision measuring up to 20 %. This helps for an easy device design



**Clear marking**

The large marking area supports a distinct and legible marking.

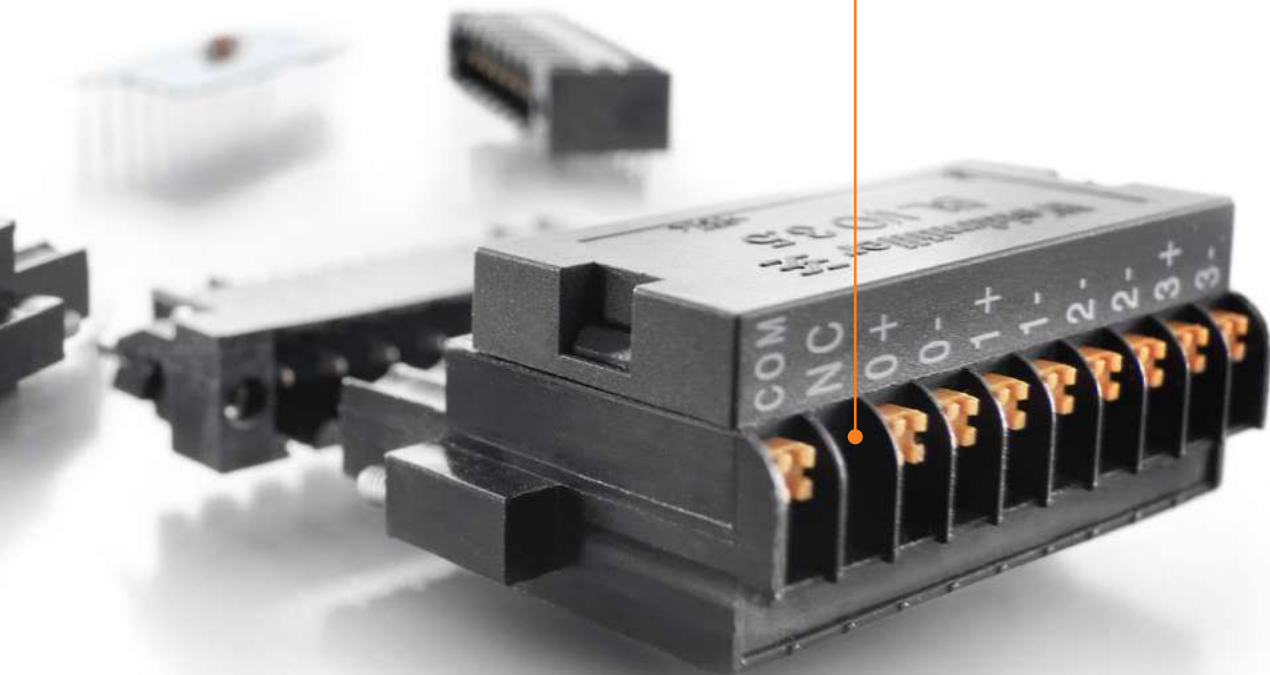
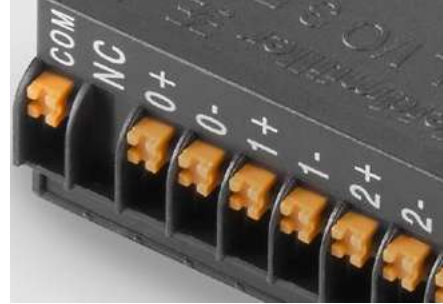





E

**Your special advantages**

- PUSH IN connector for conductor cross sections up to 1.5 mm<sup>2</sup>
- Cold junction compensation for the connection of thermocouples
- Up to four measuring connections for thermocouples
- High component density in a compact design
- Clearly visible marking area for labels
- Integrated mounting flanges

<http://www.OMNIMATE.net>

-  = Wire-to-Board
-  = Board-to-Board
-  = Wire-to-Wire
-  = Board-to-Wire

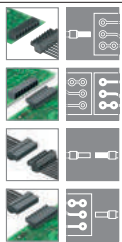

**Orientation**

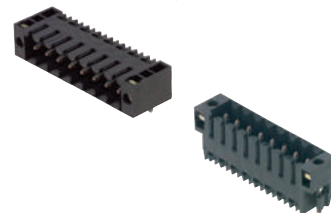
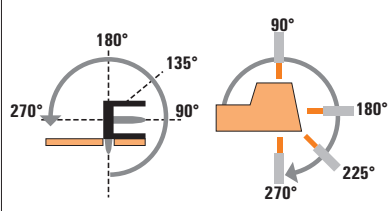

**BL/SL 3.50 series**

Levels

1



Type	Orientation		SL-SMT	SL-SMT
	Flange options		G/F/LF/RF	G/F/LF
	IEC / UL		IEC: 320 V/15 A UL: 300 V/10 A	IEC: 320 V/15 A UL: 300 V/10 A
			90°	180°

Female plug	Clamping yoke	Image	Type	Orientation	Flange options	IEC / UL	90°	180°
							○	○
Female plug	Clamping yoke		BL	180°	(G)/F/LH/LR	IEC: 320 V/17 A/0.2 - 1.5 mm <sup>2</sup> UL: 300 V/10 A/AWG 28 - 14	○	○
			BL	90°	(G)/F	IEC: 320 V/12 A/0.2 - 1.5 mm <sup>2</sup> UL: 300 V/8 A/AWG 28 - 14	○	○
			BL	270°	(G)/F	IEC: 320 V/12 A/0.2 - 1.5 mm <sup>2</sup> UL: 300 V/8 A/AWG 28 - 14	○	○
	PUSH IN		BLF	180°	(G)/F/LH/LR	IEC: 320 V/14.5 A/0.2 - 1.5 mm <sup>2</sup> UL: 300 V/10 A/AWG 26 - 14	○	○
		IDC Bus		BLIDCB	180°	(G)/F	IEC: 250 V/6 A/0.35 - 0.5 mm <sup>2</sup> UL: 300 V/7 A/AWG 22 - 20	○
Spring PUSH IN	Spring PUSH IN		BL-I/O 10 Pole	180°	F/LR/FP	IEC: 200 V/2.2 A/0.2 - 1.0 mm <sup>2</sup> UL: ≤ 200 V/5 A/AWG 22 - 16	○	○
			BL-I/O 30 Pole	180°	F/LR/FP	IEC: 200 V/2.2 A/0.2 - 1.0 mm <sup>2</sup> UL: ≤ 200 V/5 A/AWG 22 - 16	○	○
Female header	Solder con.		BLL	180°	(G)	IEC: 320 V/15.1 A UL: 300 V/10 A	●	●

**Female plug:**

- (G)\* = Closed (without flange)
- F = Screw flange with screw
- LH = Release lever
- LR = Lock & Release lever
- FP = shifted flange

**Male header:**

- (O)\* = open
- G = Closed (without flange)
- F = Flange with nut
- LF = Solder flange with nut
- RF = Locking flange for LR with solder pin

\* not included in the article description

Male header



Solder connection

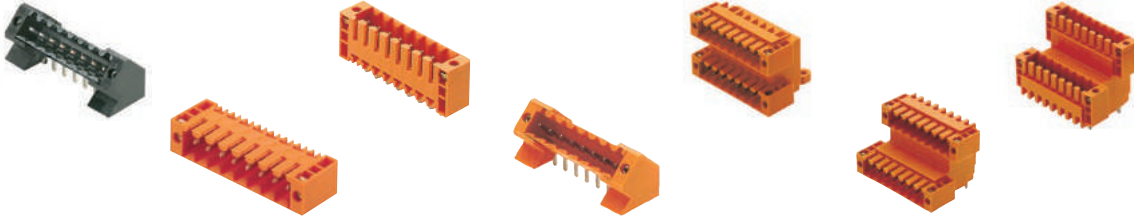

1		1			2		
SL-THR	SL	SL	SL	SLD	SLD V	SLD V	
135°	90°	180°	135°	90°	90°	180°	
F	(0)/G/F	(0)/G/F	F	G/F	G/F	G/F	
IEC: 320 V/15 A UL: 300 V/10 A	IEC: 320 V/15 A UL: 300 V/10 A	IEC: 320 V/15 A UL: 300 V/10 A	IEC: 320 V/15 A UL: 300 V/10 A	IEC: 200 V/10.5 A UL: 300 V/8 A	IEC: 200 V/10.5 A UL: 300 V/8 A	IEC: 200 V/10.5 A UL: 300 V/8 A	
○	○	○	○	○	○	○	
○	○	○	○	○	○	○	
○	○	○	○	○	○	○	
○	○	○	○	○	○	○	
○	○	○	○	○	○	○	
○	○	○	○	○	○	○	
○	○	○	○	○	○	○	
○	○	○	○	○	○	○	
○	○	○	○	○	○	○	
●	●	●	●	●	●	●	



### SL-SMT 3.50/./90

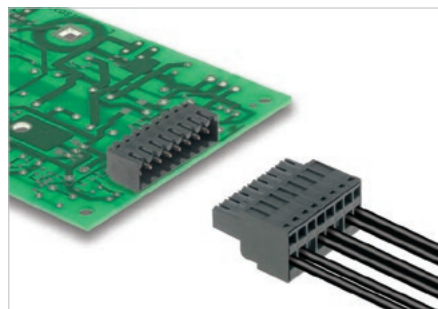

High-temperature-resistant, angled, male header for all common soldering methods in 3.5 mm pitch.

- Optimised for SMT processing.
- 3.2 mm older pin suitable for reflow and wave soldering.
- The Male headers provide space for labelling and can be coded.
- Available in closed (G) version and with solder flange (LF).
- Packed either in box (BX) or on tape-on-reel (RL).

### Product data

IEC: 320 V / 15 A  
UL: 300 V / 10 A



For additional articles and information, refer to [catalog.weidmueller.com](http://catalog.weidmueller.com)

#### Note:

- Gold-plated contact surfaces on request
- Rated current related to rated cross-section & min. No. of poles.
- Diameter of solder eyelet  $D = 1.4 \pm 0.1$  mm
- Solder eyelet diameter  $D = 1.5 \pm 0.1$  mm, from 9 poles
- P on drawing = pitch
- Rated data refer only to the component itself. Clearance and creepage distances to other components are to be designed in accordance with the relevant application standards.

### SL-SMT 3.50/./90G Box



#### Dimensioned drawing

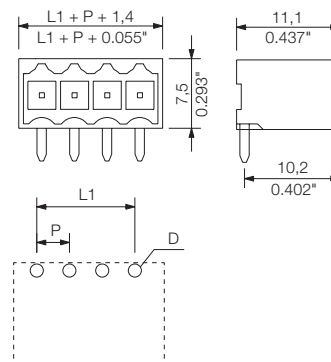

### Technical data

In compliance with IEC 60664-1 / IEC 61984			
Clamping range, max.			
<b>Solid core H05(07) V-U</b>			
Stranded H07 V-R			
Flexible H05(07) V-K			
Flexible with ferrule			
Ferrule with plastic collar			
Stripping length			
Screwdriver blade			mm
According to norm			
Tightening torque range			
<b>Rated current, max.</b>	<b>A</b>	<b>15</b>	<b>13</b>
At ambient temperature		20°C	40°C
For conductor cross-section			
Overvoltage category		III	III II
Pollution severity		3	2 2
<b>Rated voltage</b>	<b>V</b>	<b>160</b>	<b>160 320</b>
Rated impulse voltage	kV	2.5	2.5 2.5
<b>UL / CUL (Use Group)</b>		<b>B</b>	<b>C D</b>
<b>Rated voltage</b>	<b>V</b>	<b>300</b>	<b>300</b>
<b>Rated current</b>	<b>A</b>	<b>10</b>	<b>10</b>
<b>AWG conductor</b>	<b>AWG</b>		
<b>CSA (Use Group)</b>		<b>B</b>	<b>C D</b>
Rated voltage	V	300	300
Rated current	A	10	10
AWG conductor	AWG		
General data			
Type of insulation material		LCP GF	
UL 94 flammability rating		V-0	
Contact base material		CuSn	
Material of contact surface		tinned	
Pin dimensions = d	mm	1.2, Octagonal	
Solder eyelet Ø = D	mm	1.4	
Solder eyelet Ø tolerance	mm	+ 0,1	

### Accessories

Note: Refer to the Accessories chapter for additional accessories.

Coding	Order No.
BL SL 3.5 KO OR	<b>1693430000</b>
BL SL 3.5 KO SW	<b>1610100000</b>
Interlock	
BL/SL 3.50 VR OR BX	<b>1669310000</b>
BL/SL 3.50 VR BK BX	<b>1669300000</b>
LED light guide	
SL 3.5 FLA 1.5/8	<b>1597510000</b>
SL 3.5 FLA 2.3/8	<b>1597520000</b>
SL 3.5 FLA 4.0/8	<b>1597530000</b>
SL 3.5 FLA 1.5/1.75/8	<b>1597630000</b>
SL 3.5 FLA 2.3/1.75/8	<b>1597640000</b>
SL 3.5 FLA 4.0/1.75/8	<b>1597650000</b>
Mounting screw	
PTSC KA 2.2x4.5 WN1412	<b>1610740000</b>

### Ordering data

Solder pin length		3.2 mm		
Colour		Black		
Pitch		3.50 mm		
Pol.	L1	(inch)	Qty.	Order No.
2	3.50	0.138	100	<b>1841630000</b>
3	7.00	0.276	100	<b>1841640000</b>
4	10.50	0.413	100	<b>1841650000</b>
5	14.00	0.551	50	<b>1841660000</b>
6	17.50	0.689	50	<b>1841670000</b>
7	21.00	0.827	50	<b>1841680000</b>
8	24.50	0.965	50	<b>1841690000</b>
9	28.00	1.102	50	<b>1841700000</b>
10	31.50	1.240	50	<b>1841710000</b>
11	35.00	1.378	50	<b>1841720000</b>
12	38.50	1.516	50	<b>1841730000</b>
13	42.00	1.654	50	<b>1841740000</b>
14	45.50	1.791	50	<b>1841750000</b>
15	49.00	1.929	50	<b>1841760000</b>
16	52.50	2.067	50	<b>1841770000</b>
17	56.00	2.205	20	<b>1841780000</b>
18	59.50	2.343	20	<b>1841790000</b>
19	63.00	2.480	20	<b>1841800000</b>
20	66.50	2.618	20	<b>1841810000</b>
21	70.00	2.756	20	<b>1841820000</b>
22	73.50	2.894	20	<b>1841830000</b>
23	77.00	3.031	20	<b>1841840000</b>
24	80.50	3.169	20	<b>1841850000</b>

### SL-SMT 3.50/./90G Tape

closed side; tape-on-reel



Dimensioned drawing

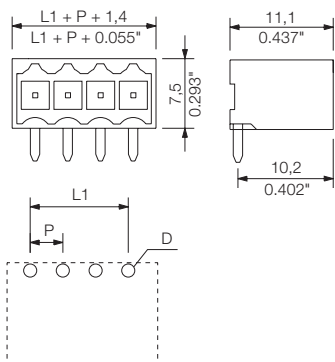

#### Ordering data

Solder pin length		1.5 mm	
Colour		Black	
Pitch		3.50 mm	
Pol.	L1	(inch)	Qty. Order No.
2	3.50	0.138	385 1761544002
3	7.00	0.276	385 1761554002
4	10.50	0.413	385 1761564001
5	14.00	0.551	385 1761574002
6	17.50	0.689	385 1761584001
7	21.00	0.827	385 1761594001
8	24.50	0.965	385 1761604001
9	28.00	1.102	385 1761614001
10	31.50	1.240	385 1761624001
11	35.00	1.378	385 1761634001

Tape widths: 32, 44, 56, 72, 88

### SL-SMT 3.50/./90LF Box

closed side; tape-on-reel



Dimensioned drawing

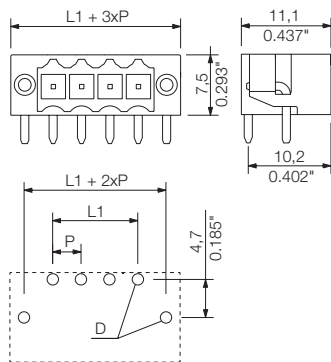

#### Ordering data

Solder pin length		3.2 mm	
Colour		Black	
Pitch		3.50 mm	
Pol.	L1	(inch)	Qty. Order No.
2	3.50	0.138	132 1841860000
3	7.00	0.276	102 1841870000
4	10.50	0.413	84 1841880000
5	14.00	0.551	72 1841890000
6	17.50	0.689	66 1841900000
7	21.00	0.827	54 1841910000
8	24.50	0.965	48 1841920000
9	28.00	1.102	48 1841930000
10	31.50	1.240	42 1841940000
11	35.00	1.378	36 1841950000
12	38.50	1.516	36 1804340000
13	42.00	1.654	30 1841960000
14	45.50	1.791	30 1841970000
15	49.00	1.929	30 1841980000
16	52.50	2.067	24 1841990000
17	56.00	2.205	24 1842000000
18	59.50	2.343	24 1842010000
19	63.00	2.480	24 1842020000
20	66.50	2.618	24 1842030000
21	70.00	2.756	18 1842040000
22	73.50	2.894	18 1842050000
23	77.00	3.031	18 1842060000
24	80.50	3.169	18 1842070000

### SL-SMT 3.50/./90LF Tape

with solder flange; tape-on-reel



Dimensioned drawing

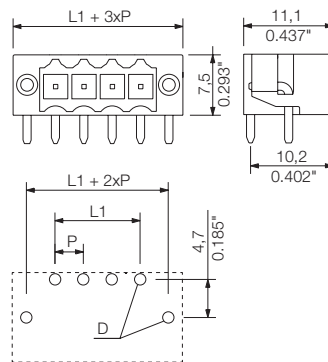

#### Ordering data

Solder pin length		1.5 mm	
Colour		Black	
Pitch		3.50 mm	
Pol.	L1	(inch)	Qty. Order No.
2	3.50	0.138	385 1805310000
3	7.00	0.276	385 1805320000
4	10.50	0.413	385 1805330000
5	14.00	0.551	385 1805340000
6	17.50	0.689	385 1805350000
7	21.00	0.827	385 1805360000
8	24.50	0.965	385 1805370000
9	28.00	1.102	385 1805380000
10	31.50	1.240	385 1005180000

Tape widths: 32, 44, 56, 72, 88

## Connectors in 3.50 mm pitch Series BL/SL 3.50

### SL-SMT 3.50/./ F & RF

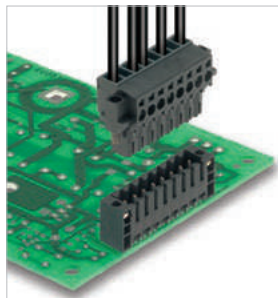

High-temperature-resistant, straight and angled, male header for all common soldering methods in 3.5 mm pitch.

- Optimised for the SMT processing.
- 3.2 mm solder pin suitable for reflow and wave soldering.
- Available with screw flange (F) and with solder flange for lock and release lever (RF).

### Product data

IEC: 320 V / 15 A  
UL: 300 V / 10 A



For additional articles and information, refer to [catalog.weidmueller.com](http://catalog.weidmueller.com)

#### Note:

- Gold-plated contact surfaces on request
- Rated current related to rated cross-section & min. No. of poles.
- Diameter of solder eyelet  $D = 1.4 + 0.1$  mm
- Solder eyelet diameter  $D = 1.5 + 0.1$  mm, from 9 poles
- P on drawing = pitch
- Rated data refer only to the component itself. Clearance and creepage distances to other components are to be designed in accordance with the relevant application standards.
- For additional mechanical support for male connectors with screw flange (...F), we recommend an additional cable gland with fastening screws (sheet metal screw ISO 1481-ST 2.2x4.5 C or ISO 7049-ST 2.2x4.5 C - see Accessories). Cable gland only permitted before soldering.

### SL-SMT 3.50/./90F Box

with screw flange



#### Dimensioned drawing

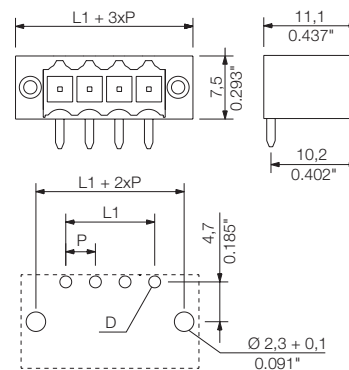

### Technical data

#### In compliance with IEC 60664-1 / IEC 61984

Clamping range, max.			
<b>Solid core H05(07) V-U</b>			
Stranded H07 V-R			
Flexible H05(07) V-K			
Flexible with ferrule			
Ferrule with plastic collar			
Stripping length			
Screwdriver blade	mm		
According to norm			
Tightening torque range			
<b>Rated current, max.</b>	<b>A</b>	<b>15</b>	<b>13</b>
At ambient temperature		20°C	40°C
For conductor cross-section			
Overvoltage category		III	III
Pollution severity		3	2
<b>Rated voltage</b>	<b>V</b>	<b>160</b>	<b>160</b>
Rated impulse voltage	kV	2.5	2.5
<b>UL / CUL (Use Group)</b>		<b>B</b>	<b>C</b>
<b>Rated voltage</b>	<b>V</b>	<b>300</b>	<b>300</b>
<b>Rated current</b>	<b>A</b>	<b>10</b>	<b>10</b>
<b>AWG conductor</b>	<b>AWG</b>		
<b>CSA (Use Group)</b>		<b>B</b>	<b>C</b>
Rated voltage	V	300	300
Rated current	A	10	10
AWG conductor	AWG		
<b>General data</b>			
Type of insulation material	LCP GF		
UL 94 flammability rating	V-0		
Contact base material	CuSn		
Material of contact surface	tinned		
Pin dimensions = d	mm	1.2, Octagonal	
Solder eyelet $\varnothing = D$	mm	1.4	
Solder eyelet $\varnothing$ tolerance	mm	+ 0.1	

### Accessories

Note: Refer to the Accessories chapter for additional accessories.

Coding		Order No.
	BL SL 3.5 KO OR	1693430000
	BL SL 3.5 KO SW	1610100000
<b>Interlock</b>		
	BL/SL 3.50 VR OR BX	1669310000
	BL/SL 3.50 VR BK BX	1669300000
<b>LED light guide</b>		
	SL 3.5 FLA 1.5/8	1597510000
	SL 3.5 FLA 2.3/8	1597520000
	SL 3.5 FLA 4.0/8	1597530000
	SL 3.5 FLA 1.5/1.75/8	1597630000
	SL 3.5 FLA 2.3/1.75/8	1597640000
	SL 3.5 FLA 4.0/1.75/8	1597650000

### Ordering data

Solder pin length		3.2 mm		
Colour		Black		
Pitch	3.50 mm			
Pol.	L1	(inch)	Qty.	Order No.
2	3.50	0.138	132	1842080000
3	7.00	0.276	102	1842090000
4	10.50	0.413	84	1842100000
5	14.00	0.551	72	1842110000
6	17.50	0.689	66	1842120000
7	21.00	0.827	54	1842130000
8	24.50	0.965	48	1842140000
9	28.00	1.102	48	1842150000
10	31.50	1.240	42	1842160000
11	35.00	1.378	36	1842170000
12	38.50	1.516	36	1842180000
13	42.00	1.654	30	1842190000
14	45.50	1.791	30	1842200000
15	49.00	1.929	30	1842210000
16	52.50	2.067	24	1842220000
17	56.00	2.205	24	1842230000
18	59.50	2.343	24	1842240000
19	63.00	2.480	24	1842250000
20	66.50	2.618	24	1842260000
21	70.00	2.756	18	1842270000
22	73.50	2.894	18	1842280000
23	77.00	3.031	18	1842290000
24	80.50	3.169	18	1842300000

3.50

90°



### SL-SMT 3.50../90RF Box

with snap-on solder flange



#### Dimensioned drawing

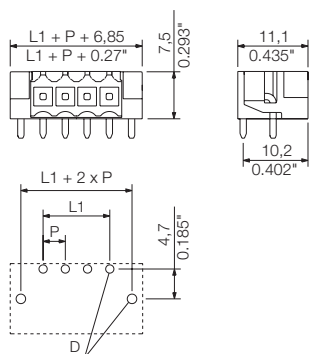

#### Ordering data

Solder pin length		1.5 mm		
Colour		Black		
Pitch		3.50 mm		
Pol.	L1	(inch)	Qty.	Order No.
2	3.50	0.138	100	1379610000
3	7.00	0.276	100	1060810000
4	10.50	0.413	100	1000600000
5	14.00	0.551	50	1000610000
6	17.50	0.689	50	1000620000
7	21.00	0.827	50	1000630000
8	24.50	0.965	50	1000640000
9	28.00	1.102	50	1000650000
10	31.50	1.240	50	1060780000
11	35.00	1.378	50	1000660000
12	38.50	1.516	50	1000670000
13	42.00	1.654	50	1000680000
14	45.50	1.791	50	1000690000
15	49.00	1.929	50	1000700000
16	52.50	2.067	50	1060820000

Compatible with release latch (LR)

Connectors in 3.50 mm pitch  
Series BL/SL 3.50

SL-SMT 3.50../180

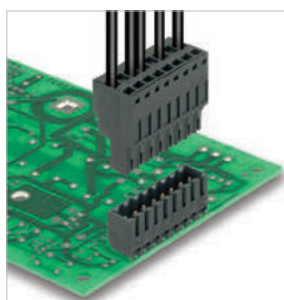

High-temperature-resistant, straight (180°) male header for all common soldering methods in 3.50 mm pitch. Optimised for the SMT process. Packed in box or tape. Pin length 1.5 mm optimised for reflow soldering methods. Pin length 3.2 mm universal for all soldering methods. The male connectors provide space for labelling and can be coded.

Product data

IEC: 320 V / 15 A  
UL: 300 V / 10 A



For additional articles and information, refer to [catalog.weidmueller.com](http://catalog.weidmueller.com)

Note:

- Gold-plated contact surfaces on request
- Rated current related to rated cross-section & min. No. of poles.
- Diameter of solder eyelet  $D = 1.4 \pm 0.1$  mm
- Solder eyelet diameter  $D = 1.5 \pm 0.1$  mm, from 9 poles
- P on drawing = pitch
- Rated data refer only to the component itself. Clearance and creepage distances to other components are to be designed in accordance with the relevant application standards.

SL SMT 3.50../180G Box

closed side



Dimensioned drawing

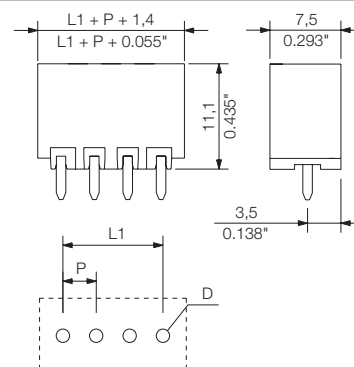

Technical data

In compliance with IEC 60664-1 / IEC 61984

Clamping range, max.			
<b>Solid core H05(07) V-U</b>			
Stranded H07 V-R			
Flexible H05(07) V-K			
Flexible with ferrule			
Ferrule with plastic collar			
Stripping length			
Screwdriver blade	mm		
According to norm			
Tightening torque range			
<b>Rated current, max.</b>	<b>A</b>	<b>15</b>	<b>13</b>
At ambient temperature		20°C	40°C
For conductor cross-section		III	III II
Overtoltage category		3	2 2
Pollution severity		3	2 2
<b>Rated voltage</b>	<b>V</b>	<b>160</b>	<b>160 320</b>
Rated impulse voltage	kV	2.5	2.5 2.5
<b>UL / CUL (Use Group)</b>		<b>B</b>	<b>C D</b>
<b>Rated voltage</b>	<b>V</b>	<b>300</b>	<b>300</b>
<b>Rated current</b>	<b>A</b>	<b>10</b>	<b>10</b>
<b>AWG conductor</b>	<b>AWG</b>		-
<b>CSA (Use Group)</b>		<b>B</b>	<b>C D</b>
Rated voltage	V	300	300
Rated current	A	10	10
AWG conductor	AWG		-
<b>General data</b>			
Type of insulation material		LCP GF	
UL 94 flammability rating		V-0	
Contact base material		CuSn	
Material of contact surface		tinned	
Pin dimensions = d	mm	1.2, Octagonal	
Solder eyelet Ø = D	mm	1.4	
Solder eyelet Ø tolerance	mm	+ 0,1	

Accessories

Note: Refer to the Accessories chapter for additional accessories.

Coding		Order No.
	BL SL 3.5 KO OR	1693430000
	BL SL 3.5 KO SW	1610100000
<b>Interlock</b>		
	BL/SL 3.50 VR OR BX	1669310000
	BL/SL 3.50 VR BK BX	1669300000

Ordering data

Solder pin length		3.2 mm		
Colour		Black		
Pitch	3.50 mm			
Pol.	L1	(inch)	Qty.	Order No.
2	3.50	0.138	100	1842320000
3	7.00	0.276	100	1842330000
4	10.50	0.413	100	1842340000
5	14.00	0.551	50	1842350000
6	17.50	0.689	50	1842360000
7	21.00	0.827	50	1842370000
8	24.50	0.965	50	1842380000
9	28.00	1.102	50	1842390000
10	31.50	1.240	50	1836990000
11	35.00	1.378	50	1842400000
12	38.50	1.516	50	1842410000
13	42.00	1.654	50	1842420000
14	45.50	1.791	50	1842430000
15	49.00	1.929	50	1842440000
16	52.50	2.067	50	1842450000
17	56.00	2.205	20	1842460000
18	59.50	2.343	20	1842470000
19	63.00	2.480	20	1842480000
20	66.50	2.618	20	1842490000
21	70.00	2.756	20	1842500000
22	73.50	2.894	20	1842510000
23	77.00	3.031	20	1842520000
24	80.50	3.169	20	1842530000

3.50

180°

**SL SMT 3.50/./180G Tape**

closed side; tape-on-reel



Dimensioned drawing

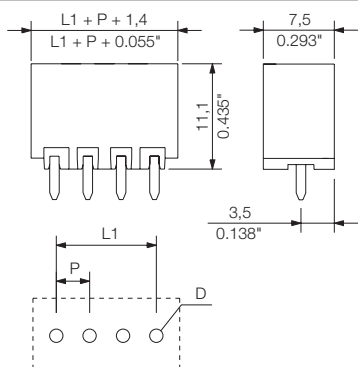

**Ordering data**

Solder pin length		1.5 mm	
Colour		Black	
Pitch		3.50 mm	
Pol.	L1 (inch)	Qty.	Order No.
2	3.50 0.138	265	1752984002
3	7.00 0.276	265	1752994002
4	10.50 0.413	265	1753004002
5	14.00 0.551	265	1753014002
6	17.50 0.689	265	1753024001
7	21.00 0.827	265	1753034001
8	24.50 0.965	265	1753044001
9	28.00 1.102	265	1753054001
10	31.50 1.240	265	1753064001
11	35.00 1.378	265	1753074001

Tape widths: 32, 44, 56, 72, 88

**SL SMT 3.50/./180LF Box**

with solder flange



Dimensioned drawing

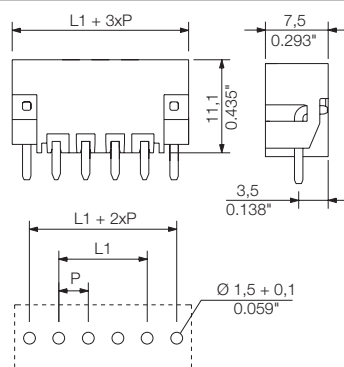

**Ordering data**

Solder pin length		3.2 mm	
Colour		Black	
Pitch		3.50 mm	
Pol.	L1 (inch)	Qty.	Order No.
2	3.50 0.138	132	1842540000
3	7.00 0.276	102	1842550000
4	10.50 0.413	84	1842560000
5	14.00 0.551	72	1842570000
6	17.50 0.689	66	1842580000
7	21.00 0.827	54	1842590000
8	24.50 0.965	48	1842600000
9	28.00 1.102	48	1842610000
10	31.50 1.240	42	1842620000
11	35.00 1.378	36	1842630000
12	38.50 1.516	36	1842640000
13	42.00 1.654	30	1842650000
14	45.50 1.791	30	1842660000
15	49.00 1.929	30	1842670000
16	52.50 2.067	24	1842680000
17	56.00 2.205	24	1842690000
18	59.50 2.343	24	1842700000
19	63.00 2.480	24	1842710000
20	66.50 2.618	24	1842720000
21	70.00 2.756	18	1842730000
22	73.50 2.894	18	1842740000
23	77.00 3.031	18	1842750000
24	80.50 3.169	18	1842760000

**SL SMT 3.50/./180LF Tape**

with solder flange; tape-on-reel



Dimensioned drawing

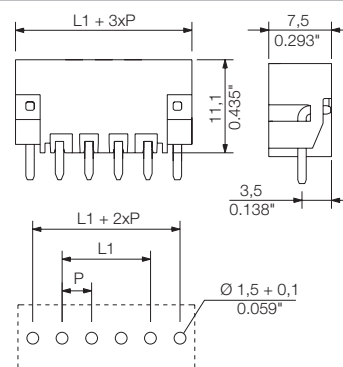

**Ordering data**

Solder pin length		1.5 mm	
Colour		Black	
Pitch		3.50 mm	
Pol.	L1 (inch)	Qty.	Order No.
2	3.50 0.138	265	1805210000
3	7.00 0.276	265	1805230000
4	10.50 0.413	265	1805240000
5	14.00 0.551	265	1805250000
6	17.50 0.689	265	1805270000
7	21.00 0.827	265	1805280000
8	24.50 0.965	265	1805290000
9	28.00 1.102	265	1805300000
10	31.50 1.138	265	1936340000

Tape widths: 32, 44, 56, 72, 88

## Connectors in 3.50 mm pitch Series BL/SL 3.50

### SL 3.50/./90

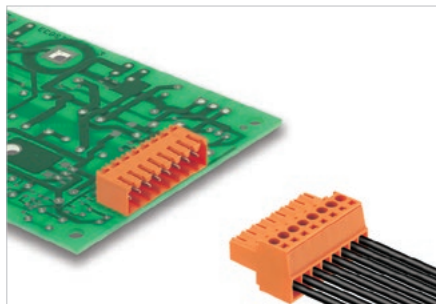

Angled male header (90° orientation) for wave soldering in 3.5 mm pitch. The male header is available in open, closed (G) and flange (F) versions. Packed in cardboard box.

### Product data

IEC: 320 V / 17 A  
UL: 300 V / 10 A



For additional articles and information, refer to [catalog.weidmuller.com](http://catalog.weidmuller.com)

#### Note:

- Additional colours on request
- Gold-plated contact surfaces on request
- Rated current related to rated cross-section & min. No. of poles.
- P on drawing = pitch
- Rated data refer only to the component itself. Clearance and creepage distances to other components are to be designed in accordance with the relevant application standards.

### SL 3.50/./90

open side

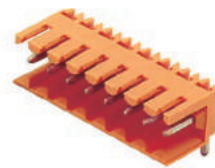

#### Dimensioned drawing

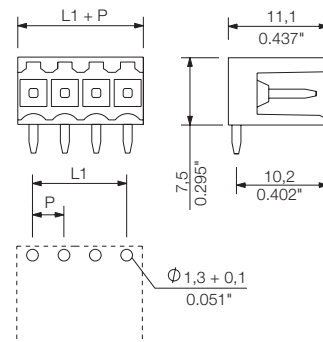

### Technical data

#### In compliance with IEC 60664-1 / IEC 61984

Clamping range, max.			
<b>Solid core H05(07) V-U</b>			
Stranded H07 V-R			
Flexible H05(07) V-K			
Flexible with ferrule			
Ferrule with plastic collar			
Stripping length			
Screwdriver blade	mm		
According to norm			
Tightening torque range			
<b>Rated current, max.</b>	<b>A</b>	<b>17</b>	<b>14.5</b>
At ambient temperature		20°C	40°C
For conductor cross-section			
Overvoltage category		III	III II
Pollution severity		3	2 2
<b>Rated voltage</b>	<b>V</b>	<b>160</b>	<b>160 320</b>
Rated impulse voltage	kV	2.5	2.5 2.5
<b>UL / CUL (Use Group)</b>		<b>B</b>	<b>C D</b>
<b>Rated voltage</b>	<b>V</b>	<b>300</b>	<b>300</b>
<b>Rated current</b>	<b>A</b>	<b>10</b>	<b>10</b>
<b>AWG conductor</b>	<b>AWG</b>		
<b>CSA (Use Group)</b>		<b>B</b>	<b>C D</b>
Rated voltage	V	300	300
Rated current	A	10	10
AWG conductor	AWG		
<b>General data</b>			
Type of insulation material		PBT	
UL 94 flammability rating		V-0	
Contact base material		CuSn	
Material of contact surface		tinned	
Pin dimensions = d	mm	1.2, Octagonal	
Solder eyelet $\varnothing = D$	mm	1.4	
Solder eyelet $\varnothing$ tolerance	mm	+ 0,1	

### Accessories

Note: Refer to the Accessories chapter for additional accessories.

Coding		Order No.
	BL SL 3.5 KO OR	1693430000
	BL SL 3.5 KO SW	1610100000
<b>Interlock</b>		
	BL/SL 3.50 VR OR BX	1669310000
	BL/SL 3.50 VR BK BX	1669300000
<b>LED light guide</b>		
	SL 3.5 FLA 1.5/8	1597510000
	SL 3.5 FLA 2.3/8	1597520000
	SL 3.5 FLA 4.0/8	1597530000
	SL 3.5 FLA 1.5/1.75/8	1597630000
	SL 3.5 FLA 2.3/1.75/8	1597640000
	SL 3.5 FLA 4.0/1.75/8	1597650000
<b>Mounting screw</b>		
	PTSC KA 2.2X4.5 WN1412	1610740000

### Ordering data

Solder pin length		3.2 mm		
Colour		Orange		
Pitch	3.50 mm			
Pol.	L1	(inch)	Qty.	Order No.
2	3.50	0.138	100	1597210000
3	7.00	0.276	100	1597220000
4	10.50	0.413	100	1597230000
5	14.00	0.551	50	1597240000
6	17.50	0.689	50	1597250000
7	21.00	0.827	50	1597260000
8	24.50	0.965	50	1597270000
9	28.00	1.102	50	1597280000
10	31.50	1.240	50	1597290000
11	35.00	1.378	50	1597300000
12	38.50	1.516	50	1597310000
13	42.00	1.654	50	1597320000
14	45.50	1.791	50	1597330000
15	49.00	1.929	50	1597340000
16	52.50	2.067	50	1597350000
17	56.00	2.205	20	1618990000
18	59.50	2.343	20	1619000000
19	63.00	2.480	20	1619010000
20	66.50	2.618	20	1619020000
21	70.00	2.756	20	1619030000
22	73.50	2.894	20	1619040000
23	77.00	3.031	20	1619050000
24	80.50	3.169	20	1619060000

3.50

90°

SL 3.50/./90G

closed side

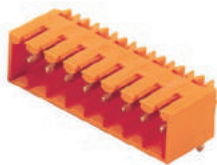

Dimensioned drawing

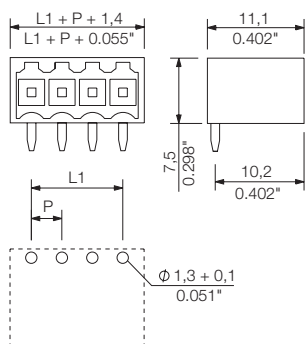

SL 3.50/./90F

with screw flange



Dimensioned drawing

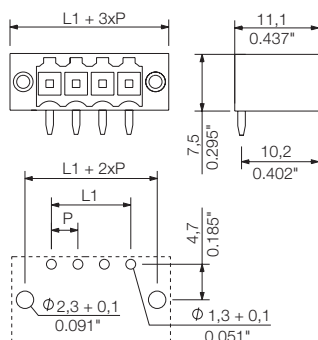

Ordering data

Solder pin length		3.2 mm	
Colour		Orange	
Pitch		3.50 mm	
Pol.	L1	(inch)	Qty. Order No.
2	3.50	0.138	100 1605070000
3	7.00	0.276	100 1605080000
4	10.50	0.413	100 1605090000
5	14.00	0.551	50 1605100000
6	17.50	0.689	50 1605110000
7	21.00	0.827	50 1605120000
8	24.50	0.965	50 1605130000
9	28.00	1.102	50 1605140000
10	31.50	1.240	50 1605150000
11	35.00	1.378	50 1605160000
12	38.50	1.516	50 1605170000
13	42.00	1.654	50 1605180000
14	45.50	1.791	50 1605190000
15	49.00	1.929	50 1605200000
16	52.50	2.067	50 1605210000
17	56.00	2.205	20 1619380000
18	59.50	2.343	20 1619390000
19	63.00	2.480	20 1619400000
20	66.50	2.618	20 1619410000
21	70.00	2.756	20 1619420000
22	73.50	2.894	20 1619430000
23	77.00	3.031	20 1619440000
24	80.50	3.169	20 1619450000

Ordering data

Solder pin length		3.2 mm	
Colour		Orange	
Pitch		3.50 mm	
Pol.	L1	(inch)	Qty. Order No.
2	3.50	0.138	100 1607040000
3	7.00	0.276	100 1607050000
4	10.50	0.413	100 1607060000
5	14.00	0.551	50 1607070000
6	17.50	0.689	50 1607080000
7	21.00	0.827	50 1607090000
8	24.50	0.965	50 1607100000
9	28.00	1.102	50 1607110000
10	31.50	1.240	50 1607120000
11	35.00	1.378	50 1607130000
12	38.50	1.516	50 1607140000
13	42.00	1.654	50 1607150000
14	45.50	1.791	50 1607160000
15	49.00	1.929	50 1607170000
16	52.50	2.067	50 1607180000
17	56.00	2.205	20 1619770000
18	59.50	2.343	20 1619780000
19	63.00	2.480	20 1619790000
20	66.50	2.618	20 1619800000
21	70.00	2.756	20 1619810000
22	73.50	2.894	20 1619820000
23	77.00	3.031	20 1619830000
24	80.50	3.169	20 1619840000

SL 3.50/./180

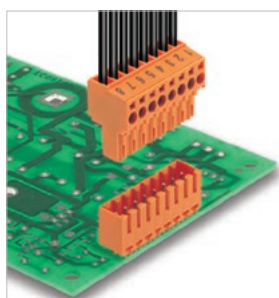

Straight male header (180° orientation) for wave soldering in 3.5 mm pitch. The male header is available in open, closed (G) and flange (F) versions. Packed in cardboard box.

Product data

IEC: 320 V / 17 A  
UL: 300 V / 10 A



For additional articles and information, refer to [catalog.weidmueller.com](http://catalog.weidmueller.com)

Note:

- Additional colours on request
- Gold-plated contact surfaces on request
- Rated current related to rated cross-section & min. No. of poles.
- P on drawing = pitch
- Rated data refer only to the component itself. Clearance and creepage distances to other components are to be designed in accordance with the relevant application standards.

SL 3.50/./180

open side

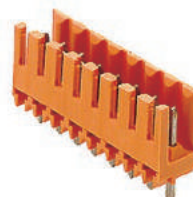

Dimensioned drawing

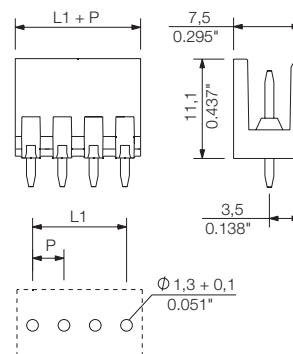

Technical data

In compliance with IEC 60664-1 / IEC 61984

Clamping range, max.			
<b>Solid core H05(07) V-U</b>			
Stranded H07 V-R			
Flexible H05(07) V-K			
Flexible with ferrule			
Ferrule with plastic collar			
Stripping length			
Screwdriver blade	mm		
According to norm			
Tightening torque range			
<b>Rated current, max.</b>	<b>A</b>	<b>17</b>	<b>14.5</b>
At ambient temperature		20°C	40°C
For conductor cross-section			
Overvoltage category		III	III II
Pollution severity		3	2 2
<b>Rated voltage</b>	<b>V</b>	<b>160</b>	<b>160 320</b>
Rated impulse voltage	kV	2.5	2.5 2.5
<b>UL / CUL (Use Group)</b>	<b>B C D</b>		
<b>Rated voltage</b>	<b>V</b>	<b>300</b>	<b>300</b>
<b>Rated current</b>	<b>A</b>	<b>10</b>	<b>10</b>
<b>AWG conductor</b>	<b>AWG</b>	-	
<b>CSA (Use Group)</b>	<b>B C D</b>		
Rated voltage	V	300	300
Rated current	A	10	10
AWG conductor	AWG	-	
<b>General data</b>			
Type of insulation material			PBT
UL 94 flammability rating			V-0
Contact base material			CuSn
Material of contact surface			tinned
Pin dimensions = d	mm	1.2, Octagonal	
Solder eyelet Ø = D	mm	1.4	
Solder eyelet Ø tolerance	mm	+ 0,1	

Accessories

Note: Refer to the Accessories chapter for additional accessories.

Coding		Order No.
	BL SL 3.5 KO OR	1693430000
	BL SL 3.5 KO SW	1610100000
<b>Interlock</b>		
	BL/SL 3.50 VR OR BX	1669310000
	BL/SL 3.50 VR BK BX	1669300000
<b>Mounting screw</b>		
	PTSC KA 2.2X4.5 WN1412	1610740000

Ordering data

Solder pin length		3.2 mm		
Colour		Orange		
Pitch	3.50 mm			
Pol.	L1	(inch)	Qty.	Order No.
2	3.50	0.138	100	1604770000
3	7.00	0.276	100	1604780000
4	10.50	0.413	100	1604790000
5	14.00	0.551	50	1604800000
6	17.50	0.689	50	1604810000
7	21.00	0.827	50	1604820000
8	24.50	0.965	50	1604830000
9	28.00	1.102	50	1604840000
10	31.50	1.240	50	1604850000
11	35.00	1.378	50	1604860000
12	38.50	1.516	50	1604870000
13	42.00	1.654	50	1604880000
14	45.50	1.791	50	1604890000
15	49.00	1.929	50	1604900000
16	52.50	2.067	50	1604910000
17	56.00	2.205	20	1621400000
18	59.50	2.343	20	1621410000
19	63.00	2.480	20	1621420000
20	66.50	2.618	20	1621430000
21	70.00	2.756	20	1621440000
22	73.50	2.894	20	1621450000
23	77.00	3.031	20	1621460000
24	80.50	3.169	20	1621470000

SL 3.50/././180G

closed side

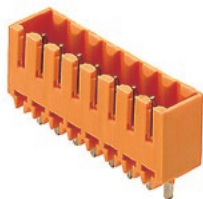

Dimensioned drawing

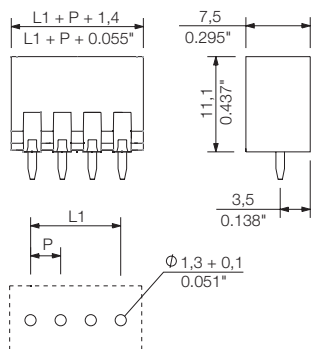

Ordering data

Solder pin length		3.2 mm	
Colour		Orange	
Pitch	3.50 mm		
Pol.	L1	(inch)	Qty. Order No.
2	3.50	0.138	100 1604470000
3	7.00	0.276	100 1604480000
4	10.50	0.413	100 1604490000
5	14.00	0.551	50 1604500000
6	17.50	0.689	50 1604510000
7	21.00	0.827	50 1604520000
8	24.50	0.965	50 1604530000
9	28.00	1.102	50 1604540000
10	31.50	1.240	50 1604550000
11	35.00	1.378	50 1604560000
12	38.50	1.516	50 1604570000
13	42.00	1.654	50 1604580000
14	45.50	1.791	50 1604590000
15	49.00	1.929	50 1604600000
16	52.50	2.067	50 1604610000
17	56.00	2.205	20 1621790000
18	59.50	2.343	20 1621800000
19	63.00	2.480	20 1621810000
20	66.50	2.618	20 1621820000
21	70.00	2.756	20 1621830000
22	73.50	2.894	20 1621840000
23	77.00	3.031	20 1621850000
24	80.50	3.169	20 1621860000

SL 3.50/././180F

with screw flange

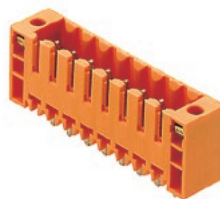

Dimensioned drawing

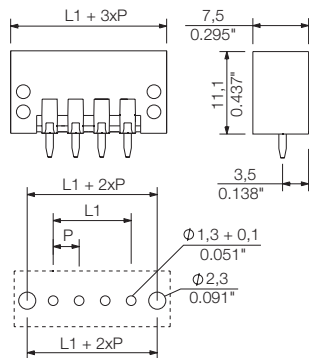

Ordering data

Solder pin length		3.2 mm	
Colour		Orange	
Pitch	3.50 mm		
Pol.	L1	(inch)	Qty. Order No.
2	3.50	0.138	100 1607500000
3	7.00	0.276	100 1607510000
4	10.50	0.413	100 1607520000
5	14.00	0.551	50 1607530000
6	17.50	0.689	50 1607540000
7	21.00	0.827	50 1607550000
8	24.50	0.965	50 1607560000
9	28.00	1.102	50 1607570000
10	31.50	1.240	50 1607580000
11	35.00	1.378	50 1607590000
12	38.50	1.516	50 1607600000
13	42.00	1.654	50 1607610000
14	45.50	1.791	50 1607620000
15	49.00	1.929	50 1607630000
16	52.50	2.067	50 1607640000
17	56.00	2.205	20 1622180000
18	59.50	2.343	20 1622190000
19	63.00	2.480	20 1622200000
20	66.50	2.618	20 1622210000
21	70.00	2.756	20 1622220000
22	73.50	2.894	20 1622230000
23	77.00	3.031	20 1622240000
24	80.50	3.169	20 1622250000

## Connectors in 3.50 mm pitch Series BL/SL 3.50

### SL 3.50/..../135

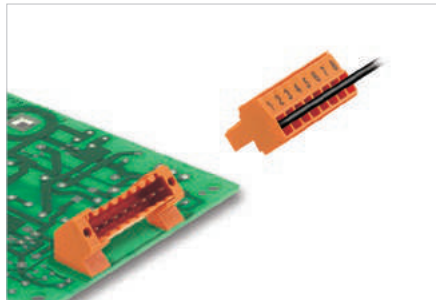

Angled male header (135° orientation) for wave soldering in 3.5 mm pitch. The male header is available in closed (G) and flange (F) versions.

### Product data

IEC: 320 V / 15 A  
UL: 300 V / 10 A



For additional articles and information, refer to [catalog.weidmueller.com](http://catalog.weidmueller.com)

#### Note:

- Additional colours on request
- Gold-plated contact surfaces on request
- Rated current related to rated cross-section & min. No. of poles.
- P on drawing = pitch
- Rated data refer only to the component itself. Clearance and creepage distances to other components are to be designed in accordance with the relevant application standards.

### SL 3.50/..../135F

with screw flange



#### Dimensioned drawing

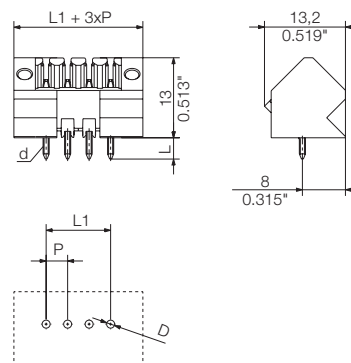

### Technical data

#### In compliance with IEC 60664-1 / IEC 61984

Clamping range, max.			
<b>Solid core H05(07) V-U</b>			
Stranded H07 V-R			
Flexible H05(07) V-K			
Flexible with ferrule			
Ferrule with plastic collar			
Stripping length			
Screwdriver blade	mm		
According to norm			
Tightening torque range			
<b>Rated current, max.</b>	<b>A</b>	<b>15</b>	<b>13</b>
At ambient temperature		20°C	40°C
For conductor cross-section		III	III II
Overtoltage category		3	2 2
Pollution severity		3	2 2
<b>Rated voltage</b>	<b>V</b>	<b>160</b>	<b>160 320</b>
Rated impulse voltage	kV	2.5	2.5 2.5
<b>UL / CUL (Use Group)</b>		<b>B</b>	<b>C D</b>
<b>Rated voltage</b>	<b>V</b>	<b>300</b>	<b>300</b>
<b>Rated current</b>	<b>A</b>	<b>10</b>	<b>10</b>
<b>AWG conductor</b>	<b>AWG</b>		-
<b>CSA (Use Group)</b>		<b>B</b>	<b>C D</b>
Rated voltage	V	300	300
Rated current	A	10	10
AWG conductor	AWG		-
<b>General data</b>			
Type of insulation material		PBT	
UL 94 flammability rating		V-0	
Contact base material		CuSn	
Material of contact surface		tinned	
Pin dimensions = d	mm	1.2, Octagonal	
Solder eyelet Ø = D	mm	1.4	
Solder eyelet Ø tolerance	mm	+ 0,1	

### Accessories

Note: Refer to the Accessories chapter for additional accessories.

Coding		Order No.
	BL SL 3.5 KO OR	1693430000
	BL SL 3.5 KO SW	1610100000
<b>Interlock</b>		
	BL/SL 3.50 VR OR BX	1669310000
	BL/SL 3.50 VR BK BX	1669300000

### Ordering data

Solder pin length		3.2 mm		
Colour		Orange		
Pitch	3.50 mm			
Pol.	L1	(inch)	Qty.	Order No.
2	3.50	0.138	132	1643330000
3	7.00	0.276	102	1643340000
4	10.50	0.413	84	1643350000
5	14.00	0.551	72	1643360000
6	17.50	0.689	66	1643370000
7	21.00	0.827	54	1643380000
8	24.50	0.965	48	1643390000
9	28.00	1.102	48	1643400000
10	31.50	1.240	42	1643410000
11	35.00	1.378	36	1643420000
12	38.50	1.516	36	1643430000
13	42.00	1.654	30	1643440000
14	45.50	1.791	30	1643450000
15	49.00	1.929	30	1643460000
16	52.50	2.067	24	1643470000
17	56.00	2.205	24	1643480000
18	59.50	2.343	24	1643490000
19	63.00	2.480	24	1643500000
20	66.50	2.618	24	1643510000
21	70.00	2.756	18	1643520000
22	73.50	2.894	18	1643530000
23	77.00	3.031	18	1643540000
24	80.50	3.169	18	1643550000

3.50

135°



### SL-THR 3.50/././135

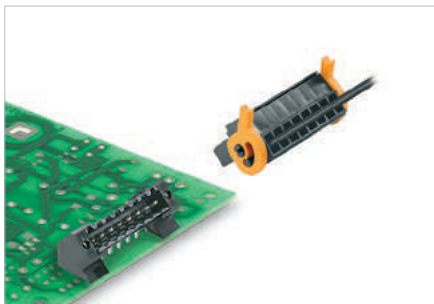

High-temperature-resistant, 135° angled, male header for all common soldering methods in 3.5 mm pitch. 3.2 mm solder pin suitable for reflow and wave soldering. The pin headers provide space for labelling and can be coded.

### Product data

IEC: 320 V / 15 A  
UL: 300 V / 10 A



For additional articles and information, refer to [catalog.weidmueller.com](http://catalog.weidmueller.com)

#### Note:

- Gold-plated contact surfaces on request
- Rated current related to rated cross-section & min. No. of poles.
- Diameter of solder eyelet  $D = 1.4 \pm 0.1$  mm
- Solder eyelet diameter  $D = 1.5 \pm 0.1$  mm, from 9 poles
- P on drawing = pitch
- Rated data refer only to the component itself. Clearance and creepage distances to other components are to be designed in accordance with the relevant application standards.

### SL-THR 3.50/././135F

with screw flange



#### Dimensioned drawing

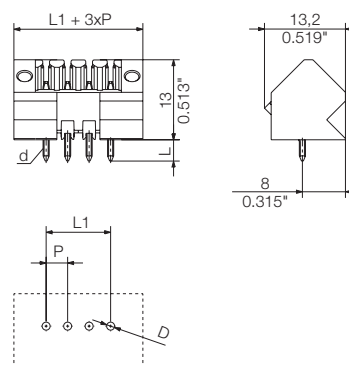

### Technical data

#### In compliance with IEC 60664-1 / IEC 61984

Clamping range, max.			
<b>Solid core H05(07) V-U</b>			
Stranded H07 V-R			
Flexible H05(07) V-K			
Flexible with ferrule			
Ferrule with plastic collar			
Stripping length			
Screwdriver blade	mm		
According to norm			
Tightening torque range			
<b>Rated current, max.</b>	<b>A</b>	<b>15</b>	<b>13</b>
At ambient temperature		20°C	40°C
For conductor cross-section		III	III II
Overtoltage category		3	2 2
Pollution severity		3	2 2
<b>Rated voltage</b>	<b>V</b>	<b>160</b>	<b>160 320</b>
Rated impulse voltage	kV	2.5	2.5 2.5
<b>UL / CUL (Use Group)</b>	<b>B C D</b>		
<b>Rated voltage</b>	<b>V</b>	<b>300</b>	<b>300</b>
<b>Rated current</b>	<b>A</b>	<b>10</b>	<b>10</b>
<b>AWG conductor</b>	<b>AWG</b>	-	
<b>CSA (Use Group)</b>	<b>B C D</b>		
Rated voltage	V	300	300
Rated current	A	10	10
AWG conductor	AWG	-	
<b>General data</b>			
Type of insulation material	LCP GF		
UL 94 flammability rating	V-0		
Contact base material	CuSn		
Material of contact surface	tinned		
Pin dimensions = d	mm	1.2, Octagonal	
Solder eyelet Ø = D	mm	1.3	
Solder eyelet Ø tolerance	mm	+ 0,1	

### Accessories

Note: Refer to the Accessories chapter for additional accessories.

Coding		Order No.
	BL SL 3.5 KO OR	1693430000
	BL SL 3.5 KO SW	1610100000
<b>Interlock</b>		
	BL/SL 3.50 VR OR BX	1669310000
	BL/SL 3.50 VR BK BX	1669300000

### Ordering data

Solder pin length		3.2 mm		
Colour		Black		
Pitch	3.50 mm			
Pol.	L1	(inch)	Qty.	Order No.
2	3.50	0.138	132	1003510000
3	7.00	0.276	102	1003520000
4	10.50	0.413	84	1003530000
5	14.00	0.551	72	1003540000
6	17.50	0.689	66	1003550000
7	21.00	0.827	54	1003560000
8	24.50	0.965	48	1003570000
9	28.00	1.102	48	1003580000
10	31.50	1.240	42	1003590000
11	35.00	1.378	36	1003600000
12	38.50	1.516	36	1003620000
13	42.00	1.654	30	1003630000
14	45.50	1.791	30	1003640000
15	49.00	1.929	30	1003650000
16	52.50	2.067	24	1003660000
17	56.00	2.205	24	1003670000
18	59.50	2.343	24	1003680000
19	63.00	2.480	24	1003690000
20	66.50	2.618	24	1003700000
21	70.00	2.756	18	1003710000
22	73.50	2.894	18	1003720000
23	77.00	3.031	18	1003730000
24	80.50	3.169	18	1003740000

SLD 3.50/./90

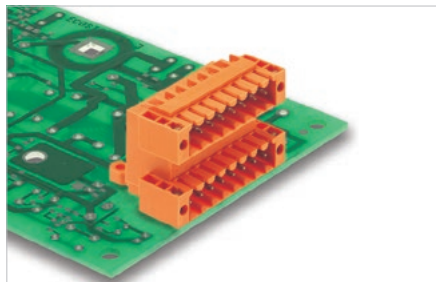

Double-level, angled male header (90° orientation) for wave soldering in 3.5 mm pitch. The male header is available in open, closed (G) and flange (F) versions.

Product data

IEC: 200 V / 10.5 A  
UL: 300 V / 8 A



For additional articles and information, refer to [catalog.weidmuller.com](http://catalog.weidmuller.com)

Note:

- Additional colours on request
- Gold-plated contact surfaces on request
- Rated current related to rated cross-section & min. No. of poles.
- P on drawing = pitch
- Rated data refer only to the component itself. Clearance and creepage distances to other components are to be designed in accordance with the relevant application standards.

SLD 3.50/./90G

closed side



Dimensioned drawing

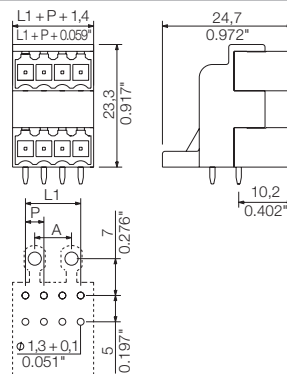

Technical data

In compliance with IEC 60664-1 / IEC 61984

Clamping range, max.			
<b>Solid core H05(07) V-U</b>			
Stranded H07 V-R			
Flexible H05(07) V-K			
Flexible with ferrule			
Ferrule with plastic collar			
Stripping length			
Screwdriver blade	mm		
According to norm			
Tightening torque range			
<b>Rated current, max.</b>	<b>A</b>	<b>10.5</b>	<b>9</b>
At ambient temperature		20°C	40°C
For conductor cross-section		III	III II
Overtoltage category		3	2 2
Pollution severity		3	2 2
<b>Rated voltage</b>	<b>V</b>	<b>125 160 200</b>	
Rated impulse voltage	kV	2.5 2.5 2.5	
<b>UL / CUL (Use Group)</b>	<b>B C D</b>		
<b>Rated voltage</b>	<b>V</b>	<b>300 300</b>	
<b>Rated current</b>	<b>A</b>	<b>8 8</b>	
<b>AWG conductor</b>	<b>AWG</b>		
<b>CSA (Use Group)</b>	<b>B C D</b>		
Rated voltage	V	300	300
Rated current	A	8	8
AWG conductor	AWG		
<b>General data</b>			
Type of insulation material		PBT	
UL 94 flammability rating		V-0	
Contact base material		CuSn	
Material of contact surface		tinned	
Pin dimensions = d	mm	1.2, Octagonal	
Solder eyelet Ø = D	mm	1.4	
Solder eyelet Ø tolerance	mm	+ 0,1	

Accessories

Note: Refer to the Accessories chapter for additional accessories.

Coding		Order No.
	BL SL 3.5 KO OR	1693430000
	BL SL 3.5 KO SW	1610100000

Ordering data

Solder pin length		3.2 mm		
Colour		Orange		
Pitch	3.50 mm			
Pol.	L1	(inch)	Qty.	Order No.
4	3.50	0.138	50	1633580000
6	7.00	0.276	50	1633590000
8	10.50	0.413	50	1633600000
10	14.00	0.551	50	1633610000
12	17.50	0.689	50	1633620000
14	21.00	0.827	20	1633630000
16	24.50	0.965	20	1633640000
18	28.00	1.102	20	1633650000
20	31.50	1.240	20	1633660000
22	35.00	1.378	10	1633670000
24	38.50	1.516	10	1633680000
26	42.00	1.654	10	1633690000
28	45.50	1.791	10	1633700000
30	49.00	1.929	10	1633710000
32	52.50	2.067	10	1633720000
34	56.00	2.205	10	1633730000
36	59.50	2.343	10	1633740000
38	63.00	2.480	10	1633750000
40	66.50	2.618	10	1633760000
42	70.00	2.756	10	1633770000
44	73.50	2.894	10	1633780000
46	77.00	3.031	10	1633790000
48	80.50	3.169	10	1633800000

## SLD 3.50/./90F

with screw flange



### Dimensioned drawing

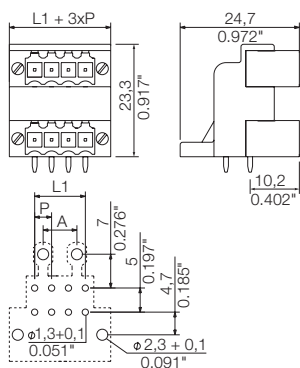

### Ordering data

Solder pin length		3.2 mm		
Colour		Orange		
Pitch		3.50 mm		
Pol.	L1	(inch)	Qty.	Order No.
4	3.50	0.138	50	1633810000
6	7.00	0.276	50	1633820000
8	10.50	0.413	50	1633830000
10	14.00	0.551	50	1633840000
12	17.50	0.689	50	1633850000
14	21.00	0.827	20	1633860000
16	24.50	0.965	20	1633870000
18	28.00	1.102	20	1633880000
20	31.50	1.240	20	1633890000
22	35.00	1.378	10	1633900000
24	38.50	1.516	10	1633910000
26	42.00	1.654	10	1633920000
28	45.50	1.791	10	1633930000
30	49.00	1.929	10	1633940000
32	52.50	2.067	10	1633950000
34	56.00	2.205	10	1633960000
36	59.50	2.343	10	1633970000
38	63.00	2.480	10	1633980000
40	66.50	2.618	10	1633990000
42	70.00	2.756	10	1634000000
44	73.50	2.894	10	1634010000
46	77.00	3.031	10	1634020000
48	80.50	3.169	10	1634030000

## Connectors in 3.50 mm pitch Series BL/SL 3.50

### SLD 3.50V/././90

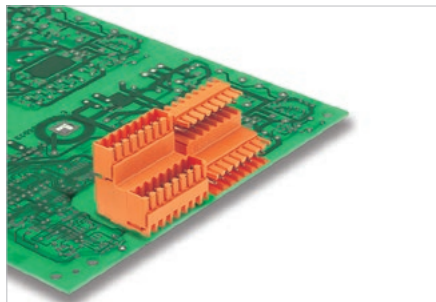

Double-level, staggered male header with angled 90° wire outlet for wave soldering in 3.5 mm pitch. The male header is available in open, closed (G) and flange (F) versions.

### Product data

IEC: 200 V / 10.5 A  
UL: 300 V / 8 A



For additional articles and information, refer to [catalog.weidmuller.com](http://catalog.weidmuller.com)

#### Note:

- Additional colours on request
- Rated current related to rated cross-section & min. No. of poles.
- Spacing between rows: see hole layout
- P on drawing = pitch
- Rated data refer only to the component itself. Clearance and creepage distances to other components are to be designed in accordance with the relevant application standards.

### SLD 3.50V/././90G

closed side



#### Dimensioned drawing

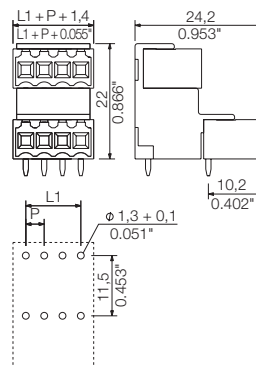

### Technical data

#### In compliance with IEC 60664-1 / IEC 61984

Clamping range, max.			
<b>Solid core H05(07) V-U</b>			
Stranded H07 V-R			
Flexible H05(07) V-K			
Flexible with ferrule			
Ferrule with plastic collar			
Stripping length			
Screwdriver blade	mm		
According to norm			
Tightening torque range			
<b>Rated current, max.</b>	<b>A</b>	<b>10.5</b>	<b>9</b>
At ambient temperature		20°C	40°C
For conductor cross-section			
Overtoltage category		III	III II
Pollution severity		3	2 2
<b>Rated voltage</b>	<b>V</b>	<b>125 160 200</b>	
Rated impulse voltage	kV	2.5 2.5 2.5	
<b>UL / CUL (Use Group)</b>	<b>B C D</b>		
<b>Rated voltage</b>	<b>V</b>	<b>300</b>	<b>300</b>
<b>Rated current</b>	<b>A</b>	<b>8</b>	<b>8</b>
<b>AWG conductor</b>	<b>AWG</b>		-
<b>CSA (Use Group)</b>	<b>B C D</b>		
Rated voltage	V	300	300
Rated current	A	8	8
AWG conductor	AWG		-
<b>General data</b>			
Type of insulation material		PBT	
UL 94 flammability rating		V-0	
Contact base material		CuSn	
Material of contact surface		tinned	
Pin dimensions = d	mm	1.2, Octagonal	
Solder eyelet Ø = D	mm	1.4	
Solder eyelet Ø tolerance	mm	+ 0,1	

### Accessories

Note: Refer to the Accessories chapter for additional accessories.

Coding		Order No.
	BL SL 3.5 KO OR	1693430000
	BL SL 3.5 KO SW	1610100000

### Ordering data

Solder pin length		3.2 mm		
Colour		Orange		
Pitch		3.50 mm		
Pol.	L1	(inch)	Qty.	Order No.
4	3.50	0.138	50	1642240000
6	7.00	0.276	50	1890600000
8	10.50	0.413	50	1642250000
10	14.00	0.551	50	1866770000
12	17.50	0.689	50	1642260000
14	21.00	0.827	20	1890610000
16	24.50	0.965	20	1642270000
18	28.00	1.102	20	1890620000
20	31.50	1.240	20	1642280000
22	35.00	1.378	10	1669650000
24	38.50	1.516	10	1642290000
26	42.00	1.654	10	1890630000
28	45.50	1.791	10	1642300000
30	49.00	1.929	10	1890640000
32	52.50	2.067	10	1642310000
34	56.00	2.205	10	1890650000
36	59.50	2.343	10	1642320000
38	63.00	2.480	10	1890660000
40	66.50	2.618	10	1642330000
42	70.00	2.756	10	1890670000
44	73.50	2.894	10	1642340000
46	77.00	3.031	10	1890680000
48	80.50	3.169	10	1642350000

3.50

90°

**SLD 3.50V/././90F**

with screw flange



**Dimensioned drawing**

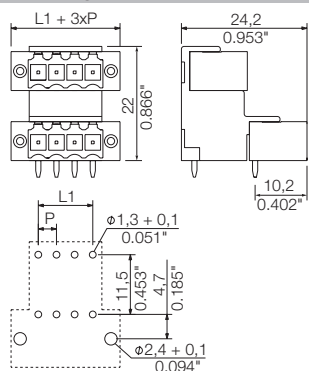

**Ordering data**

<b>Solder pin length</b>		3.2 mm		
<b>Colour</b>		Orange		
<b>Pitch</b>		3.50 mm		
Pol.	L1	(inch)	Qty.	Order No.
4	3.50	0.138	50	1642370000
6	7.00	0.276	50	1890790000
8	10.50	0.413	50	1642380000
10	14.00	0.551	50	1890800000
12	17.50	0.689	50	1642390000
14	21.00	0.827	20	1890810000
16	24.50	0.965	20	1642400000
18	28.00	1.102	20	1890820000
20	31.50	1.240	20	1642410000
22	35.00	1.378	10	1669660000
24	38.50	1.516	10	1642420000
26	42.00	1.654	10	1890830000
28	45.50	1.791	10	1642430000
30	49.00	1.929	10	1890840000
32	52.50	2.067	10	1642440000
34	56.00	2.205	10	1890850000
36	59.50	2.343	10	1642450000
38	63.00	2.480	10	1890860000
40	66.50	2.618	10	1642460000
42	70.00	2.756	10	1890870000
44	73.50	2.894	10	1642470000
46	77.00	3.031	10	1890880000
48	80.50	3.169	10	1642480000



## Connectors in 3.50 mm pitch Series BL/SL 3.50

### SLD 3.50V/./180

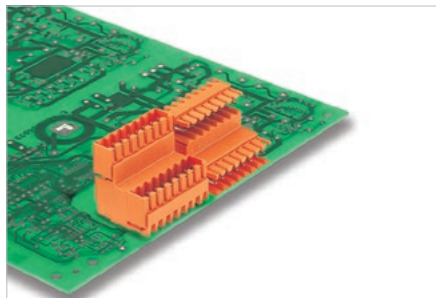

Double-level, staggered male header with straight 180° wire outlet for wave soldering in 3.5 mm pitch. The male header is available in closed (G) and flange (F) versions.

### Product data

IEC: 200 V / 10.5 A  
UL: 300 V / 8 A



For additional articles and information, refer to [catalog.weidmuller.com](http://catalog.weidmuller.com)

#### Note:

- Additional colours on request
- Rated current related to rated cross-section & min. No. of poles.
- Spacing between rows: see hole layout
- P on drawing = pitch
- Rated data refer only to the component itself. Clearance and creepage distances to other components are to be designed in accordance with the relevant application standards.

### SLD 3.50V/./180G

closed side



#### Dimensioned drawing

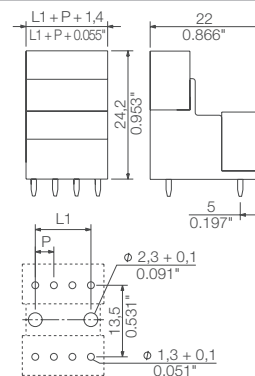

### Technical data

#### In compliance with IEC 60664-1 / IEC 61984

Clamping range, max.			
<b>Solid core H05(07) V-U</b>			
Stranded H07 V-R			
Flexible H05(07) V-K			
Flexible with ferrule			
Ferrule with plastic collar			
Stripping length			
Screwdriver blade	mm		
According to norm			
Tightening torque range			
<b>Rated current, max.</b>	<b>A</b>	<b>10.5</b>	<b>9</b>
At ambient temperature		20°C	40°C
For conductor cross-section			
Overtolerance category		III	III II
Pollution severity		3	2 2
<b>Rated voltage</b>	<b>V</b>	<b>125 160 200</b>	
Rated impulse voltage	kV	2.5 2.5 2.5	
<b>UL / CUL (Use Group)</b>	<b>B C D</b>		
<b>Rated voltage</b>	<b>V</b>	<b>300</b>	<b>300</b>
<b>Rated current</b>	<b>A</b>	<b>8</b>	<b>8</b>
<b>AWG conductor</b>	<b>AWG</b>		-
<b>CSA (Use Group)</b>	<b>B C D</b>		
Rated voltage	V	300	300
Rated current	A	8	8
AWG conductor	AWG		-
<b>General data</b>			
Type of insulation material		PBT	
UL 94 flammability rating		V-0	
Contact base material		CuSn	
Material of contact surface		tinned	
Pin dimensions = d	mm	1.2, Octagonal	
Solder eyelet Ø = D	mm	1.4	
Solder eyelet Ø tolerance	mm	+ 0,1	

### Accessories

Note: Refer to the Accessories chapter for additional accessories.

Coding		Order No.
	BL SL 3.5 KO OR	1693430000
	BL SL 3.5 KO SW	1610100000

### Ordering data

Solder pin length		3.2 mm		
Colour		Orange		
Pitch		3.50 mm		
Pol.	L1	(inch)	Qty.	Order No.
4	3.50	0.138	50	1641110000
6	7.00	0.276	50	1891190000
8	10.50	0.413	50	1641120000
10	14.00	0.551	50	1891200000
12	17.50	0.689	50	1641130000
16	24.50	0.965	20	1641140000
20	31.50	1.240	20	1641150000
24	38.50	1.516	10	1641160000
28	45.50	1.791	10	1641170000
32	52.50	2.067	10	1641180000
34	56.00	2.205	10	1891260000
36	59.50	2.343	10	1641190000
38	63.00	2.480	10	1891270000
40	66.50	2.618	10	1641200000
42	70.00	2.756	10	1891280000
44	73.50	2.894	10	1641210000
46	77.00	3.031	10	1891290000
48	80.50	3.169	10	1641220000

**SLD 3.50V../180F**

with screw flange

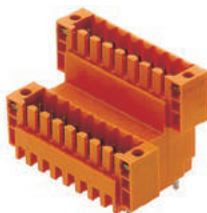

**Dimensioned drawing**

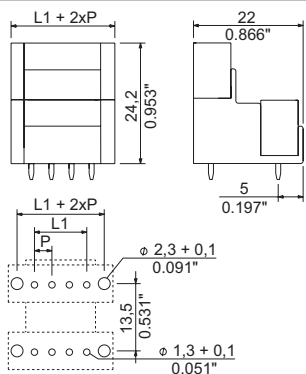

**Ordering data**

<b>Solder pin length</b>		3.2 mm		
<b>Colour</b>		Orange		
<b>Pitch</b>		3.50 mm		
Pol.	L1	(inch)	Qty.	Order No.
4	3.50	0.138	50	1641240000
6	7.00	0.276	50	1891060000
8	10.50	0.413	50	1641250000
10	14.00	0.551	50	1891070000
12	17.50	0.689	50	1641260000
14	21.00	0.827	20	1891080000
16	24.50	0.965	20	1641270000
18	28.00	1.102	20	1891090000
20	31.50	1.240	20	1641280000
22	35.00	1.378	20	1891100000
24	38.50	1.516	10	1641290000
26	42.00	1.654	10	1891110000
28	45.50	1.791	10	1641300000
30	49.00	1.929	10	1891120000
32	52.50	2.067	10	1641310000
34	56.00	2.205	10	1891130000
36	59.50	2.343	10	1641320000
38	63.00	2.480	10	1891140000
40	66.50	2.618	10	1641330000
42	70.00	2.756	10	1891150000
44	73.50	2.894	10	1641340000
46	77.00	3.031	10	1891160000
48	80.50	3.169	10	1641350000

BL 3.50/././180

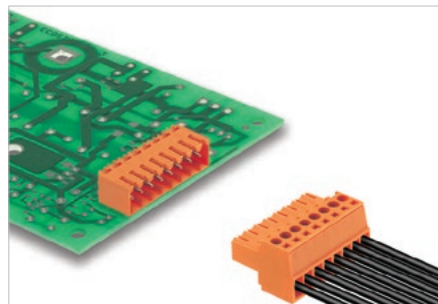

Female plug with clamping-yoke screw system for connecting wires with straight outlet direction in 3.5 mm pitch. Available with a screw flange (F), release lever (LH) or lock and release lever (LR). They include space for labelling and can be coded.

Product data

IEC: 320 V / 17 A / 0.2 - 1.5 mm<sup>2</sup>  
UL: 300 V / 10 A / AWG 28 - 14



For additional articles and information, refer to [catalog.weidmueller.com](http://catalog.weidmueller.com)

Note:

- Additional colours on request
- Gold-plated contact surfaces on request
- Rated current related to rated cross-section & min. No. of poles.
- Max. outer diameter of the conductor: 2.9 mm
- Wire end ferrule without plastic collar to DIN 46228/1
- Wire end ferrule with plastic collar to DIN 46228/4
- P on drawing = pitch
- Rated data refer only to the component itself. Clearance and creepage distances to other components are to be designed in accordance with the relevant application standards.

BL 3.50/././180



Dimensioned drawing

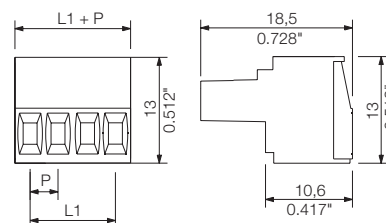

Technical data

In compliance with IEC 60664-1 / IEC 61984			
Clamping range, max.	mm <sup>2</sup>	0.08...1.5	
<b>Solid core H05(07) V-U</b>	mm <sup>2</sup>	<b>0.2...1.5</b>	
Stranded H07 V-R			
Flexible H05(07) V-K	mm <sup>2</sup>	0.2...1.5	
Flexible with ferrule	mm <sup>2</sup>	0.2...1.5	
Ferrule with plastic collar	mm <sup>2</sup>	0.2...1.5	
Stripping length	mm	6	
Screwdriver blade	mm	0.4 x 2.5	
According to norm		DIN 5264	
Tightening torque range	Nm	0.2...0.25	
<b>Rated current, max.</b>	<b>A</b>	<b>17</b>	<b>14.5</b>
At ambient temperature		20°C	40°C
For conductor cross-section	mm <sup>2</sup>	1.5	
Overvoltage category		III	III II
Pollution severity		3	2 2
<b>Rated voltage</b>	<b>V</b>	<b>160</b>	<b>160 320</b>
Rated impulse voltage	kV	2.5	2.5 2.5
<b>UL / CUL (Use Group)</b>		<b>B</b>	<b>C D</b>
<b>Rated voltage</b>	<b>V</b>	<b>300</b>	<b>300</b>
<b>Rated current</b>	<b>A</b>	<b>10</b>	<b>10</b>
<b>AWG conductor</b>	<b>AWG</b>	<b>28-14</b>	
<b>CSA (Use Group)</b>		<b>B</b>	<b>C D</b>
Rated voltage	V	300	300
Rated current	A	10	10
AWG conductor	AWG	28-14	
General data			
Type of insulation material		PBT	
UL 94 flammability rating		V-0	
Contact base material		Copper alloy	
Material of contact surface		tinned	
Pin dimensions = d	mm		
Solder eyelet Ø = D	mm		
Solder eyelet Ø tolerance	mm		

Accessories

Note: Refer to the Accessories chapter for additional accessories.

Coding	Order No.
BL SL 3.5 KO OR	<b>1693430000</b>
BL SL 3.5 KO SW	<b>1610100000</b>
Cover hood	
BL 3.50 AH03 BK BX	<b>1745580000</b>
BL 3.50 AH04 BK BX	<b>1745590000</b>
BL 3.50 AH05 BK BX	<b>1745600000</b>
BL 3.50 AH06 BK BX	<b>1745610000</b>
BL 3.50 AH07 BK BX	<b>1745620000</b>
BL 3.50 AH08 BK BX	<b>1745630000</b>
BL 3.50 AH09 BK BX	<b>1745640000</b>
BL 3.50 AH10 BK BX	<b>1745650000</b>
BL 3.50 AH11 BK BX	<b>1745660000</b>
BL 3.50 AH12 BK BX	<b>1745670000</b>
BL 3.50 AH13 BK BX	<b>1745680000</b>
BL 3.50 AH14 BK BX	<b>1745690000</b>
BL 3.50 AH15 BK BX	<b>1745700000</b>
BL 3.50 AH16 BK BX	<b>1745710000</b>
Strain relief	
BL 3.50 ZE03 OR BX	<b>1629680000</b>
BL 3.50 ZE03 BK BX	<b>1627820000</b>
BL 3.50 ZE08 OR BX	<b>1629690000</b>
Interlock	
BL/SL 3.50 VR OR BX	<b>1669310000</b>
BL/SL 3.50 VR BK BX	<b>1669300000</b>
Screwdriver	
SDS 0.4X2.5X75	<b>9009030000</b>
SDIS 0.4X2.5X75	<b>9008370000</b>

Ordering data

Solder pin length				
Colour	Orange			
Pitch	3.50 mm			
Pol.	L1	(inch)	Qty.	Order No.
2	3.50	0.138	264	<b>1597360000</b>
3	7.00	0.276	174	<b>1597370000</b>
4	10.50	0.413	132	<b>1597380000</b>
5	14.00	0.551	102	<b>1597390000</b>
6	17.50	0.689	84	<b>1597400000</b>
7	21.00	0.827	72	<b>1597410000</b>
8	24.50	0.965	66	<b>1597420000</b>
9	28.00	1.102	54	<b>1597430000</b>
10	31.50	1.240	48	<b>1597440000</b>
11	35.00	1.378	48	<b>1597450000</b>
12	38.50	1.516	42	<b>1597460000</b>
13	42.00	1.654	36	<b>1597470000</b>
14	45.50	1.791	36	<b>1597480000</b>
15	49.00	1.929	30	<b>1597490000</b>
16	52.50	2.067	30	<b>1597500000</b>
17	56.00	2.205	30	<b>1620290000</b>
18	59.50	2.343	24	<b>1620300000</b>
19	63.00	2.480	24	<b>1620310000</b>
20	66.50	2.618	24	<b>1620320000</b>
21	70.00	2.756	24	<b>1620330000</b>
22	73.50	2.894	24	<b>1620340000</b>
23	77.00	3.031	18	<b>1620350000</b>
24	80.50	3.169	18	<b>1620360000</b>

Representative deratings curve

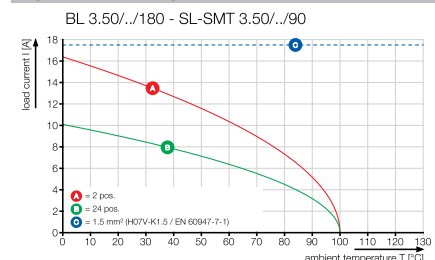



### BL 3.50/././180F

with screw flange



Dimensioned drawing

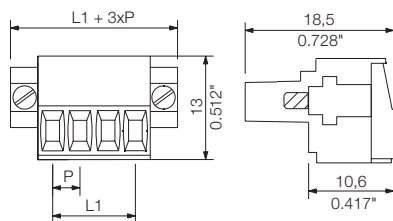

### Ordering data

Solder pin length					
Colour		Orange			
Pitch	3.50 mm				
Pol.	L1	(inch)	Qty.	Order No.	
2	3.50	0.138	132	1606640000	
3	7.00	0.276	102	1606650000	
4	10.50	0.413	84	1606660000	
5	14.00	0.551	72	1606670000	
6	17.50	0.689	66	1606680000	
7	21.00	0.827	54	1606690000	
8	24.50	0.965	48	1606700000	
9	28.00	1.102	48	1606710000	
10	31.50	1.240	42	1606720000	
11	35.00	1.378	36	1606730000	
12	38.50	1.516	36	1606740000	
13	42.00	1.654	30	1606750000	
14	45.50	1.791	30	1606760000	
15	49.00	1.929	30	1606770000	
16	52.50	2.067	24	1606780000	
17	56.00	2.205	24	1620760000	
18	59.50	2.343	24	1620770000	
19	63.00	2.480	24	1620780000	
20	66.50	2.618	24	1620790000	
21	70.00	2.756	18	1620800000	
22	73.50	2.894	18	1620810000	
23	77.00	3.031	18	1620820000	
24	80.50	3.169	18	1620830000	

### BL 3.50/././180LR

with release latch



Dimensioned drawing

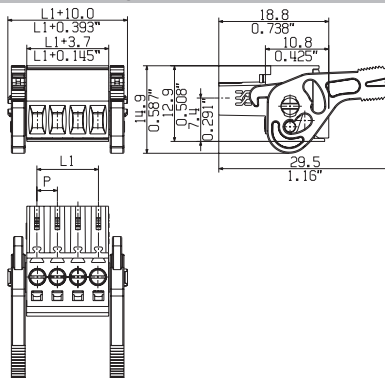

### Ordering data

Solder pin length					
Colour		Orange			
Pitch	3.50 mm				
Pol.	L1	(inch)	Qty.	Order No.	
2	3.50	0.138	132	1530990000	
3	7.00	0.276	102	1531000000	
4	10.50	0.413	84	1531010000	
5	14.00	0.551	72	1531020000	
6	17.50	0.689	66	1531030000	
7	21.00	0.827	54	1531040000	
8	24.50	0.965	48	1531050000	
9	28.00	1.102	48	1531070000	
10	31.50	1.240	42	1531080000	
11	35.00	1.378	36	1531090000	
12	38.50	1.516	36	1531100000	
13	42.00	1.654	30	1531110000	
14	45.50	1.791	30	1531120000	
15	49.00	1.929	30	1531130000	
16	52.50	2.067	24	1531140000	

### Additional deratings curves

BL 3.50/././180 - SLD 3.50/././90

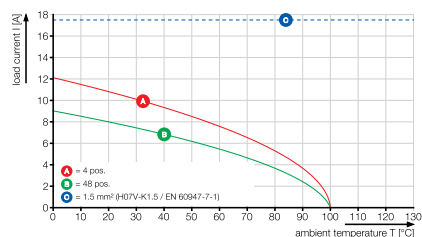

BL 3.50/././180 - SL 3.50/././90

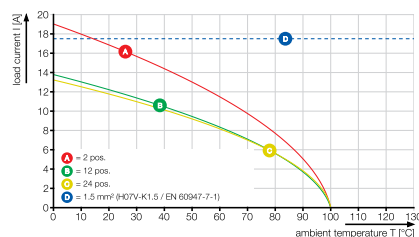

## Connectors in 3.50 mm pitch Series BL/SL 3.50

### BL 3.50/..../90 & 270

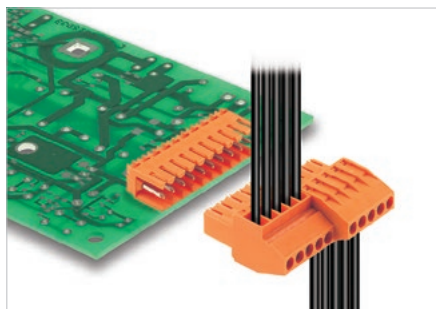

Female plug with clamping-yoke screw system for connecting wires with 90° and 270° angled orientation in 3.5 mm pitch. The female plugs are also available with a screw flange (F). They include space for labelling and can be coded.

### Product data

IEC: 320 V / 12 A / 0.2 - 1.5 mm<sup>2</sup>  
UL: 300 V / 8 A / AWG 28 - 14



For additional articles and information, refer to [catalog.weidmueller.com](http://catalog.weidmueller.com)

#### Note:

- Additional colours on request
- Gold-plated contact surfaces on request
- Rated current related to rated cross-section & min. No. of poles.
- Max. outer diameter of the conductor: 2.9 mm
- Wire end ferrule without plastic collar to DIN 46228/1
- Wire end ferrule with plastic collar to DIN 46228/4
- P on drawing = pitch
- Rated data refer only to the component itself. Clearance and creepage distances to other components are to be designed in accordance with the relevant application standards.

### BL 3.50/..../90



#### Dimensioned drawing

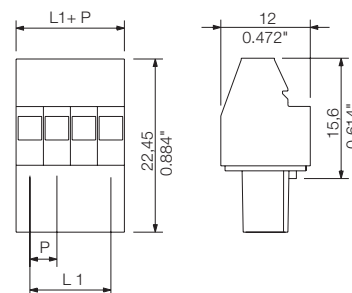

### Technical data

#### In compliance with IEC 60664-1 / IEC 61984

Clamping range, max.	mm <sup>2</sup>	0.08...1.5
<b>Solid core H05(07) V-U</b>	<b>mm<sup>2</sup></b>	<b>0.2...1.5</b>
Stranded H07 V-R		
Flexible H05(07) V-K	mm <sup>2</sup>	0.2...1.5
Flexible with ferrule	mm <sup>2</sup>	0.2...1.5
Ferrule with plastic collar	mm <sup>2</sup>	0.2...1.5
Stripping length	mm	6
Screwdriver blade	mm	0.4 x 2.5
According to norm		DIN 5264
Tightening torque range	Nm	0.2...0.25
<b>Rated current, max.</b>	<b>A</b>	<b>12 10</b>
At ambient temperature	20°C	40°C
For conductor cross-section	mm <sup>2</sup>	1.5
Overtoltage category		III III II
Pollution severity		3 2 2
<b>Rated voltage</b>	<b>V</b>	<b>160 160 320</b>
Rated impulse voltage	kV	2.5 2.5 2.5
<b>UL / CUL (Use Group)</b>	<b>B C D</b>	<b>D</b>

<b>Rated voltage</b>	<b>V</b>	<b>300 300</b>
<b>Rated current</b>	<b>A</b>	<b>8 8</b>
<b>AWG conductor</b>	<b>AWG</b>	<b>28-14</b>
<b>CSA (Use Group)</b>	<b>B C D</b>	<b>D</b>
Rated voltage	V	300 300
Rated current	A	10 10
AWG conductor	AWG	28-14

#### General data

Type of insulation material	PBT
UL 94 flammability rating	V-0
Contact base material	Copper alloy
Material of contact surface	tinned
Pin dimensions = d	mm
Solder eyelet Ø = D	mm
Solder eyelet Ø tolerance	mm

### Accessories

Note: Refer to the Accessories chapter for additional accessories.

Coding		Order No.
	BL SL 3.5 KO OR	1693430000
	BL SL 3.5 KO SW	1610100000
Screwdriver		
	SDS 0.4X2.5X75	9009030000
	SDIS 0.4X2.5X75	9008370000

### Ordering data

#### Solder pin length

Colour	Orange			
Pitch	3.50 mm			
Pol.	L1	(inch)	Qty.	Order No.
2	3.50	0.138	258	1638550000
3	7.00	0.276	174	1638560000
4	10.50	0.413	132	1638570000
5	14.00	0.551	102	1638580000
6	17.50	0.689	84	1638590000
7	21.00	0.827	72	1638600000
8	24.50	0.965	66	1638610000
9	28.00	1.102	54	1638620000
10	31.50	1.240	48	1638630000
11	35.00	1.378	48	1638640000
12	38.50	1.516	42	1638650000
13	42.00	1.654	36	1638660000
14	45.50	1.791	36	1638670000
15	49.00	1.929	30	1638680000
16	52.50	2.067	30	1638690000
17	56.00	2.205	30	1638700000
18	59.50	2.343	24	1638710000
19	63.00	2.480	24	1638720000
20	66.50	2.618	24	1638730000
21	70.00	2.756	24	1638740000
22	73.50	2.894	24	1638750000
23	77.00	3.031	18	1638760000
24	80.50	3.169	18	1638770000

#### Representative deratings curve

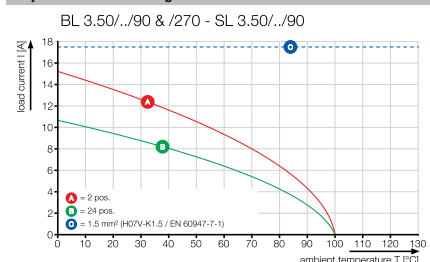

### BL 3.50/./90F

with screw flange



Dimensioned drawing

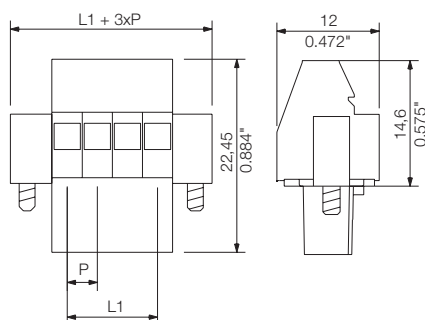

#### Ordering data

Solder pin length					
Colour					Orange
Pitch	3.50 mm		Qty.	Order No.	
Pol.	L1	(inch)			
2	3.50	0.138	156	1639010000	
3	7.00	0.276	108	1639020000	
4	10.50	0.413	90	1639030000	
5	14.00	0.551	72	1639040000	
6	17.50	0.689	66	1639050000	
7	21.00	0.827	60	1639060000	
8	24.50	0.965	54	1639070000	
9	28.00	1.102	48	1639080000	
10	31.50	1.240	42	1639090000	
11	35.00	1.378	36	1639100000	
12	38.50	1.516	36	1639110000	
13	42.00	1.654	36	1639120000	
14	45.50	1.791	30	1639130000	
15	49.00	1.929	30	1639140000	
16	52.50	2.067	30	1639150000	
17	56.00	2.205	24	1639160000	
18	59.50	2.343	24	1639170000	
19	63.00	2.480	24	1639180000	
20	66.50	2.618	24	1639190000	
21	70.00	2.756	18	1639200000	
22	73.50	2.894	18	1639210000	
23	77.00	3.031	18	1639220000	
24	80.50	3.169	18	1639230000	

### BL 3.50/./270

with screw flange



Dimensioned drawing

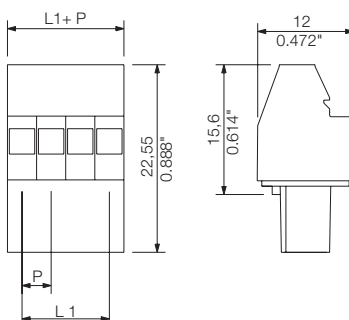

#### Ordering data

Solder pin length					
Colour					Orange
Pitch	3.50 mm		Qty.	Order No.	
Pol.	L1	(inch)			
2	3.50	0.138	258	1639470000	
3	7.00	0.276	174	1639480000	
4	10.50	0.413	132	1639490000	
5	14.00	0.551	102	1639500000	
6	17.50	0.689	84	1639510000	
7	21.00	0.827	72	1639520000	
8	24.50	0.965	66	1639530000	
9	28.00	1.102	54	1639540000	
10	31.50	1.240	48	1639550000	
11	35.00	1.378	48	1639560000	
12	38.50	1.516	42	1639570000	
13	42.00	1.654	36	1639580000	
14	45.50	1.791	36	1639590000	
15	49.00	1.929	30	1639600000	
16	52.50	2.067	30	1639610000	
17	56.00	2.205	30	1639620000	
18	59.50	2.343	24	1639630000	
19	63.00	2.480	24	1639640000	
20	66.50	2.618	24	1639650000	
21	70.00	2.756	24	1639660000	
22	73.50	2.894	24	1639670000	
23	77.00	3.031	18	1639680000	
24	80.50	3.169	18	1639690000	

### BL 3.50/./270F

with screw flange



Dimensioned drawing

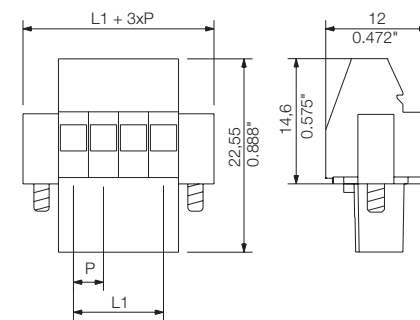

#### Ordering data

Solder pin length					
Colour					Orange
Pitch	3.50 mm		Qty.	Order No.	
Pol.	L1	(inch)			
2	3.50	0.138	156	1639930000	
3	7.00	0.276	108	1639940000	
4	10.50	0.413	90	1639950000	
5	14.00	0.551	72	1639960000	
6	17.50	0.689	66	1639970000	
7	21.00	0.827	60	1639980000	
8	24.50	0.965	54	1639990000	
9	28.00	1.102	48	1640000000	
10	31.50	1.240	42	1640010000	
11	35.00	1.378	36	1640020000	
12	38.50	1.516	36	1640030000	
13	42.00	1.654	36	1640040000	
14	45.50	1.791	30	1640050000	
15	49.00	1.929	30	1640060000	
16	52.50	2.067	30	1640070000	
17	56.00	2.205	24	1640080000	
18	59.50	2.343	24	1640090000	
19	63.00	2.480	24	1640100000	
20	66.50	2.618	24	1640110000	
21	70.00	2.756	18	1640120000	
22	73.50	2.894	18	1640130000	
23	77.00	3.031	18	1640140000	
24	80.50	3.169	18	1640150000	

BLF 3.50/././180

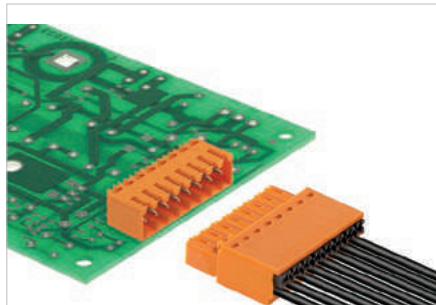

**PUSH IN** - Weidmüller's innovative connection system simplifies and accelerates the wire connection process.

- Solid wires and stranded wires with ferrules need only to be inserted and they are ready
- The actuator must be used when connecting stranded wires without ferrules
- Intuitive handling - since the wire-entry area and handling area are clearly separated
- Lock and release lever: tool-less locking and a gentle releasing of the connector reduces the mechanical stress to the solder joints

Technical data

<b>In compliance with IEC 60664-1 / IEC 61984</b>			
Clamping range, max.	mm <sup>2</sup>	0.14...1.5	
<b>Solid core H05(07) V-U</b>	mm <sup>2</sup>	<b>0.14...1.5</b>	
Stranded H07 V-R			
Flexible H05(07) V-K	mm <sup>2</sup>	0.14...1.5	
Flexible with ferrule	mm <sup>2</sup>	0.25...1	
Ferrule with plastic collar	mm <sup>2</sup>	0.25...1	
Stripping length	mm	8	
Screwdriver blade	mm	0.4 x 2.5	
According to norm		DIN 5264-A	
Tightening torque range			
<b>Rated current, max.</b>	<b>A</b>	<b>17.5</b>	<b>17.1</b>
At ambient temperature		20°C	40°C
For conductor cross-section	mm <sup>2</sup>	1.5	
Overtoltage category		III	III II
Pollution severity		3	2 2
<b>Rated voltage</b>	<b>V</b>	<b>160</b>	<b>160 320</b>
Rated impulse voltage	kV	2.5	2.5 2.5
<b>UL / CUL (Use Group)</b>		<b>B</b>	<b>C D</b>
<b>Rated voltage</b>	<b>V</b>	<b>300</b>	<b>50 300</b>
<b>Rated current</b>			<b>10</b>
<b>AWG conductor</b>	<b>AWG</b>	<b>26-16</b>	
<b>CSA (Use Group)</b>		<b>B</b>	<b>C D</b>
Rated voltage	V	300	50 300
Rated current			10
AWG conductor	AWG	26-16	
<b>General data</b>			
Type of insulation material		PA GF	
UL 94 flammability rating		V-0	
Contact base material		Copper alloy	
Material of contact surface		tinned	
Pin dimensions = d	mm		
Solder eyelet Ø = D	mm		
Solder eyelet Ø tolerance	mm		

Product data

IEC: 320 V / 17.5 A / 0.14 - 1.5 mm<sup>2</sup>  
UL: 300 V / AWG 26 - 16



For additional articles and information, refer to [catalog.weidmuller.com](http://catalog.weidmuller.com)

Note:

- Additional colours on request
- Gold-plated contact surfaces on request
- Rated current related to rated cross-section & min. No. of poles.
- Wire end ferrule without plastic collar to DIN 46228/1
- Wire end ferrule with plastic collar to DIN 46228/4
- P on drawing = pitch
- Rated data refer only to the component itself. Clearance and creepage distances to other components are to be designed in accordance with the relevant application standards.

BLF 3.50/././180



Dimensioned drawing

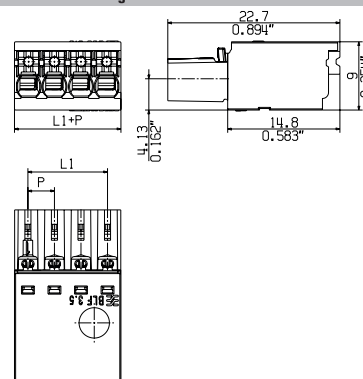

Ordering data

<b>Solder pin length</b>				
<b>Colour</b>	<b>Orange</b>			
<b>Pitch</b>	<b>3.50 mm</b>			
<b>Pol.</b>	<b>L1</b>	<b>(inch)</b>	<b>Qty.</b>	<b>Order No.</b>
2	3.50	0.138	264	2458950000
3	7.00	0.276	174	2459060000
4	10.50	0.413	132	2459070000
5	14.00	0.551	102	2459080000
6	17.50	0.689	84	2459090000
7	21.00	0.827	72	2459100000
8	24.50	0.965	66	2459110000
9	28.00	1.102	54	2459120000
10	31.50	1.240	48	2459130000
11	35.00	1.378	48	2459140000
12	38.50	1.516	42	2459150000
13	42.00	1.654	36	2459160000
14	45.50	1.791	36	2459170000
15	49.00	1.929	30	2459180000
16	52.50	2.067	30	2459190000
17	56.00	2.205	30	2459200000
18	59.50	2.343	24	2459210000
19	63.00	2.480	24	2459220000
20	66.50	2.618	24	2459230000
21	70.00	2.756	24	2459240000
22	73.50	2.894	24	2459250000
23	77.00	3.031	18	2459260000
24	80.50	3.169	18	2459270000

Representative deratings curve

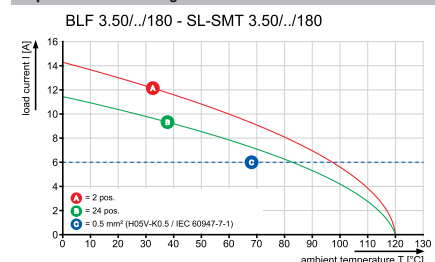

BLF 3.50../180F



Dimensioned drawing

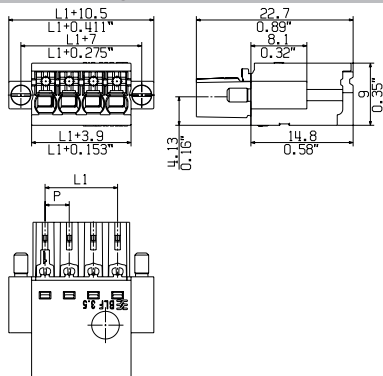

Ordering data

Solder pin length					
Colour		Orange			
Pitch		3.50 mm			
Pol.	L1	(inch)	Qty.	Order No.	
2	3.50	0.138	132	2459390000	
3	7.00	0.276	102	2459400000	
4	10.50	0.413	84	2459410000	
5	14.00	0.551	72	2459420000	
6	17.50	0.689	66	2459430000	
7	21.00	0.827	54	2459440000	
8	24.50	0.965	48	2459450000	
9	28.00	1.102	48	2459460000	
10	31.50	1.240	42	2459470000	
11	35.00	1.378	36	2459480000	
12	38.50	1.516	36	2459490000	
13	42.00	1.654	30	2459500000	
14	45.50	1.791	30	2459510000	
15	49.00	1.929	30	2459520000	
16	52.50	2.067	24	2459530000	
17	56.00	2.205	24	2459540000	
18	59.50	2.343	24	2459550000	
24	80.50	3.169	18	2459560000	

BLF 3.50../180LR



Dimensioned drawing

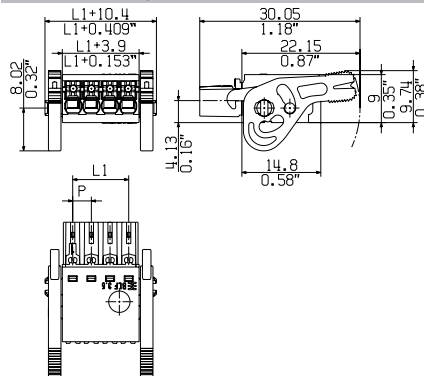

Ordering data

Solder pin length					
Colour		Orange			
Pitch		3.50 mm			
Pol.	L1	(inch)	Qty.	Order No.	
2	3.50	0.138	132	2459680000	
3	7.00	0.276	102	2459690000	
4	10.50	0.413	84	2459700000	
5	14.00	0.551	72	2459710000	
6	17.50	0.689	66	2459720000	
7	21.00	0.827	54	2459730000	
8	24.50	0.965	48	2459740000	
9	28.00	1.102	48	2459750000	
10	31.50	1.240	42	2459760000	
11	35.00	1.378	36	2459770000	
12	38.50	1.516	36	2459780000	
13	42.00	1.654	30	2459790000	
14	45.50	1.791	30	2459800000	
15	49.00	1.929	30	2459810000	
16	52.50	2.067	24	2459820000	
17	56.00	2.205	24	2538260000	
18	59.50	2.343	24	2538270000	
24	80.50	3.169	18	2459830000	

BLF 3.50../180QV



Maßzeichnung

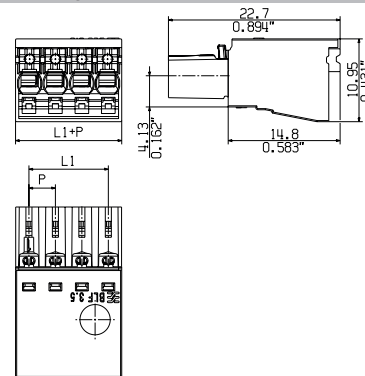

Ordering data

Solder pin length					
Colour		Orange			
Pitch		3.50 mm			
Pol.	L1	(inch)	Qty.	Order No.	
2	3.50	0.138	264	2460150000	
4	3.50	0.413	132	2460240000	

Additional deratings curves

BLF 3.50../180 - SL-SMT 3.50../180

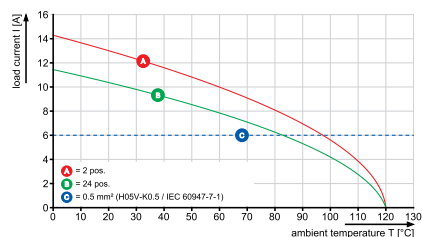

### BLIDCB 3.50/./180

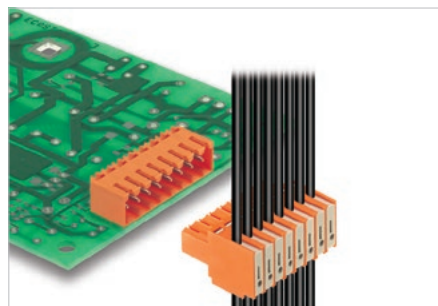

Female plug provides quick IDC wire connections in 3.5 mm pitch for bus applications. The female plugs are also available with a screw flange (F). They include space for labelling and can be coded.

### Product data

IEC: 250 V / 6 A / 0.35 - 0.5 mm<sup>2</sup>  
UL: 300 V / 7 A / AWG 22 - 20



For additional articles and information, refer to [catalog.weidmueller.com](http://catalog.weidmueller.com)

#### Note:

- Additional colours on request
- Rated current related to rated cross-section & min. No. of poles.
- For IDC contact 0.5: cable acc. to DIN EN 60352-4
- AWG conductor: solid, 7 or 19 strands only
- Temperature range -20 to +80 °C
- BLIDC 3.5 and BLIDCB 3.5 conductors "solid"/"flexible" to DIN 47726
- P on drawing = pitch
- Rated data refer only to the component itself. Clearance and creepage distances to other components are to be designed in accordance with the relevant application standards.

### BLIDCB 3.50/./180

#### Bus version



#### Dimensioned drawing

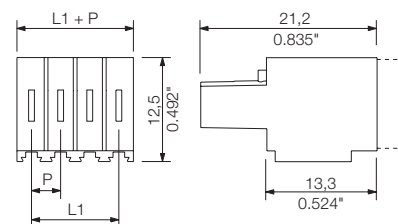

### Technical data

#### In compliance with IEC 60664-1 / IEC 61984

Clamping range, max.	mm <sup>2</sup>	0.32...0.5
<b>Solid core H05(07) V-U</b>	mm <sup>2</sup>	<b>0.35...0.5</b>
Stranded H07 V-R		
Flexible H05(07) V-K	mm <sup>2</sup>	0.35...0.5
Flexible with ferrule		
Ferrule with plastic collar		
Stripping length		
Screwdriver blade	mm	0.4 x 2.5
According to norm		DIN 5264-A
Tightening torque range		
<b>Rated current, max.</b>	<b>A</b>	<b>6 6</b>
At ambient temperature	20°C	40°C
For conductor cross-section	mm <sup>2</sup>	0.5
Overvoltage category		III III II
Pollution severity		3 2 2
<b>Rated voltage</b>	<b>V</b>	<b>160 160 250</b>
Rated impulse voltage	kV	2.5 2.5 2.5
<b>UL / CUL (Use Group)</b>	<b>B C D</b>	

<b>Rated voltage</b>	<b>V</b>	<b>300 300</b>
<b>Rated current</b>	<b>A</b>	<b>7 7</b>
<b>AWG conductor</b>	<b>AWG</b>	<b>22-20</b>
<b>CSA (Use Group)</b>	<b>B C D</b>	
Rated voltage	V	300 300
Rated current	A	7 7
AWG conductor	AWG	22-20

#### General data

Type of insulation material		PBT
UL 94 flammability rating		V-0
Contact base material		CuSn
Material of contact surface		tinned
Pin dimensions = d	mm	
Solder eyelet Ø = D	mm	
Solder eyelet Ø tolerance	mm	

### Accessories

Note: Refer to the Accessories chapter for additional accessories.

Coding		Order No.
	BL SL 3.5 KO OR	1693430000
	BL SL 3.5 KO SW	1610100000
Mounting block		
	BLIDCB 3.5 ASB	1770310000
Screwdriver		
	SDS 0.4X2.5X75	9009030000
	SDIS 0.4X2.5X75	9008370000

### Ordering data

Solder pin length		Colour	
		Orange	Black
Pitch	3.50 mm		
Pol.	L1 (inch)	Qty.	Order No.
2	3.50 0.138	10	1751380000
3	7.00 0.276	10	1751390000
4	10.50 0.413	10	1751400000
5	14.00 0.551	10	1751410000
6	17.50 0.689	10	1751420000
7	21.00 0.827	10	1751430000
8	24.50 0.965	10	1751440000 1770730000

### Representative deratings curve

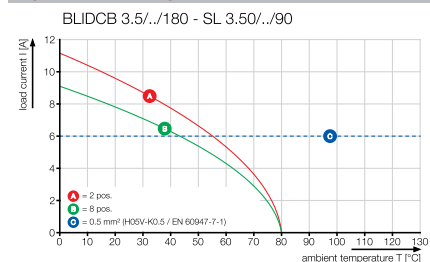

## BLIDCB 3.50/./180F

Bus version; with screw flange



Dimensioned drawing

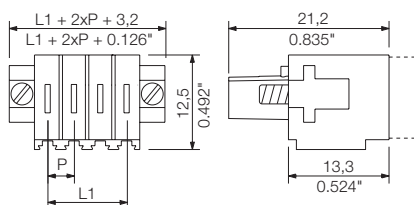

### Ordering data

Solder pin length					
Colour		Orange	Black		
Pitch 3.50 mm					
Pol.	L1	(inch)	Qty.	Order No.	Order No.
2	3.50	0.138	10	1751450000	
3	7.00	0.276	10	1751460000	
4	10.50	0.413	10	1751470000	1770760000
5	14.00	0.551	10	1751480000	
6	17.50	0.689	10	1751490000	
7	21.00	0.827	10	1751500000	
8	24.50	0.965	10	1751510000	

## Connectors in 3.50 mm pitch Series BL/SL 3.50

### BL-I/O 3.5/././180

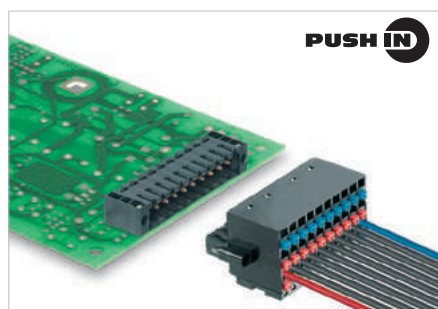

**PUSH IN**

Female plug provides pluggable connection level for decentralized I/O electronics. It is used together with male headers in 3.5 mm pitch. Available with a screw flange (F) or a lock and release lever (LR).

### Technical data

In compliance with IEC 60664-1 / IEC 61984			
Clamping range, max.	mm <sup>2</sup>	0.2...1.5	
<b>Solid core H05(07) V-U</b>	<b>mm<sup>2</sup></b>	<b>0.2...1.5</b>	
Stranded H07 V-R			
Flexible H05(07) V-K	mm <sup>2</sup>	0.2...1.5	
Flexible with ferrule	mm <sup>2</sup>	0.2...1	
Ferrule with plastic collar	mm <sup>2</sup>	0.2...0.75	
Stripping length	mm	8	
Screwdriver blade	mm	0.4 x 2.5	
		According to norm	
Tightening torque range			
<b>Rated current, max.</b>	<b>A</b>	<b>2.2</b>	<b>2.2</b>
At ambient temperature		20°C	40°C
For conductor cross-section	mm <sup>2</sup>	1	
Overvoltage category		III	III II
Pollution severity		3	2 2
<b>Rated voltage</b>	<b>V</b>	<b>50</b>	<b>160 200</b>
Rated impulse voltage	kV	0.8	2.5 2.5
<b>UL / CUL (Use Group)</b>	<b>B C D</b>		
<b>Rated voltage</b>	<b>V</b>	<b>50</b>	<b>50</b>
<b>Rated current</b>	<b>A</b>	<b>5</b>	<b>5</b>
<b>AWG conductor</b>	<b>AWG</b>	<b>24-16</b>	
<b>CSA (Use Group)</b>	<b>B C D</b>		
Rated voltage	V	50	50
Rated current	A	5	5
AWG conductor	AWG	22-16	
General data			
Type of insulation material		PBT	
UL 94 flammability rating		V-0	
Contact base material		Copper alloy	
Material of contact surface		tinned	
Pin dimensions = d	mm		
Solder eyelet Ø = D	mm		
Solder eyelet Ø tolerance	mm		

### Product data

IEC: 200 V / 2.2 A / 0.2 - 1.5 mm<sup>2</sup>  
UL: 50 V / 5 A / AWG 24 - 16



For additional articles and information, refer to [catalog.weidmuller.com](http://catalog.weidmuller.com)

#### Note:

- Additional colours on request
- P on drawing = pitch
- Crimp form A for wire end ferrules with PZ 6/5 crimping tool are recommended for the largest cable sizes.
- Total load-carrying capacity of the potential bridges when feeding with 1.5 mm<sup>2</sup> is max. 17.5 A (so the capacity is 2.18 A for poles 2 through 9)
- Wire end ferrule without plastic collar to DIN 46228/1
- Wire end ferrule with plastic collar to DIN 46228/4
- Conductor < 0.2 mm<sup>2</sup> tinned
- Max. outer diameter of the conductor: 2.9 mm
- Rated data refer only to the component itself. Clearance and creepage distances to other components are to be designed in accordance with the relevant application standards.

### BL-I/O 3.50/10/180F

with screw flange



#### Dimensioned drawing

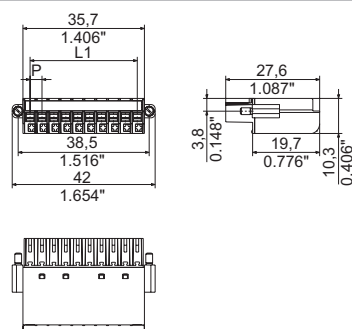

### Accessories

Note: Refer to the Accessories chapter for additional accessories.

Coding		Order No.
	BL SL 3.5 KO OR	1693430000
	BL SL 3.5 KO SW	1610100000
Screwdriver		
	SDS 0.4X2.5X75	9009030000
	SDIS 0.4X2.5X75	9008370000
Crimping tool		
	PZ 6/5	9011460000
	PZ 1.5	9005990000

### Ordering data

Solder pin length						
Colour		Light Grey	Black			
Pitch	3.50 mm					
Pol.	L1	(inch)	Qty.	Order No.	Order No.	
10	31.50	1.240	20	1871690000	1779880000	

### Representative deratings curve

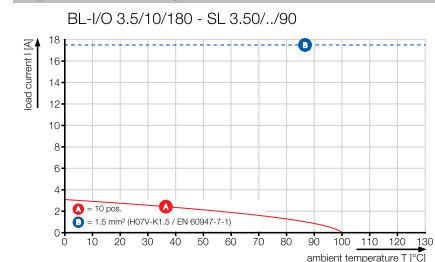



### BL-I/O 3.50/10/180LR

with release latch



Dimensioned drawing

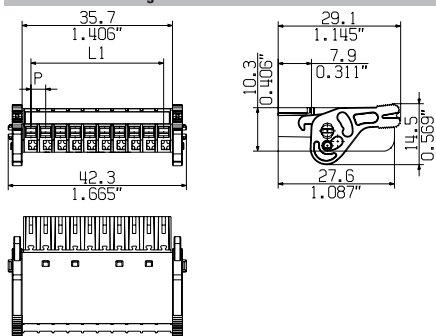

#### Ordering data

Solder pin length				
Colour	Black			
Pitch	3.50 mm			
Pol.	L1	(inch)	Qty.	Order No.
10	31.50	1.240	20	1531180000

### BL-I/O 3.50/30/180F

with screw flange



Dimensioned drawing

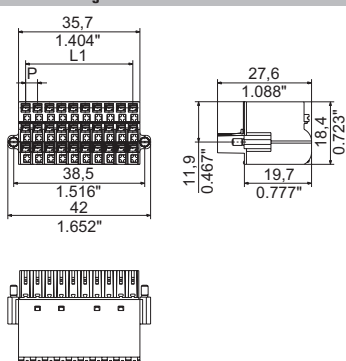

#### Ordering data

Solder pin length				
Colour	Black			
Pitch	3.50 mm			
Pol.	L1	(inch)	Qty.	Order No.
30	31.50	1.240	20	1779920000

### BL-I/O 3.50/30/180LR

with release latch



Dimensioned drawing

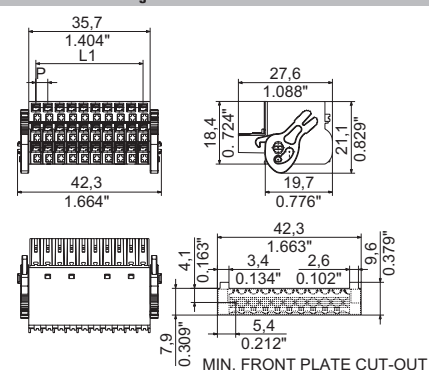

#### Ordering data

Solder pin length				
Colour	Black			
Pitch	3.50 mm			
Pol.	L1	(inch)	Qty.	Order No.
30	31.50	1.240	20	1000550000

Compatible with SL-SMT 3.50/.../90RF

#### Additional deratings curves

BL-I/O 3.5/30/180 - SL 3.50/.../90

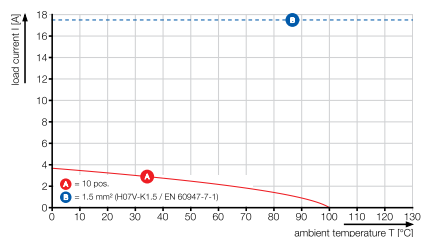

BL-I/O 3.50/./180 PNP LED

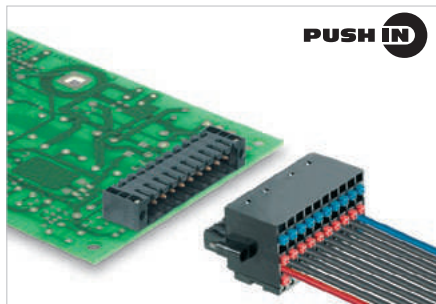

Female plug provides pluggable connection level with common minus (PNP sensor) for decentralized I/O electronics with integrated LED display; used together with male headers in 3.5 mm pitch. Available with a screw flange (F) or a lock an release lever (LR).

Technical data

<b>In compliance with IEC 60664-1 / IEC 61984</b>			
Clamping range, max.	mm <sup>2</sup>	0.2...1.5	
<b>Solid core H05(07) V-U</b>	mm <sup>2</sup>	<b>0.2...1.5</b>	
Stranded H07 V-R			
Flexible H05(07) V-K	mm <sup>2</sup>	0.2...1.5	
Flexible with ferrule	mm <sup>2</sup>	0.2...1	
Ferrule with plastic collar	mm <sup>2</sup>	0.2...0.75	
Stripping length	mm	8	
Screwdriver blade	mm	0.4 x 2.5	
According to norm			
Tightening torque range			
<b>Rated current, max.</b>	<b>A</b>	<b>2.2</b>	<b>2.2</b>
At ambient temperature		20°C	40°C
For conductor cross-section	mm <sup>2</sup>	1	
Overvoltage category		III	III II
Pollution severity		3	2 2
<b>Rated voltage</b>		<b>50</b>	
Rated impulse voltage		0.8	
<b>UL / CUL (Use Group)</b>		<b>B</b>	<b>C D</b>
<b>Rated voltage</b>	<b>V</b>	<b>50</b>	<b>50</b>
<b>Rated current</b>	<b>A</b>	<b>5</b>	<b>5</b>
<b>AWG conductor</b>	<b>AWG</b>	<b>24-16</b>	
<b>CSA (Use Group)</b>		<b>B</b>	<b>C D</b>
Rated voltage	V	50	50
Rated current	A	5	5
AWG conductor	AWG	22-16	
<b>General data</b>			
Type of insulation material		PBT	
UL 94 flammability rating		V-0	
Contact base material		Copper alloy	
Material of contact surface		tinned	
Pin dimensions = d	mm		
Solder eyelet Ø = D	mm		
Solder eyelet Ø tolerance	mm		

Product data

IEC: / 2.2 A / 0.2 - 1.5 mm<sup>2</sup>  
UL: 50 V / 5 A / AWG 24 - 16



For additional articles and information, refer to [catalog.weidmueller.com](http://catalog.weidmueller.com)

Note:

- Additional colours on request
- P on drawing = pitch
- Crimp shape A for wire-end ferrules with crimping tools PZ 1,5 (order no. 9005990000) or PZ 6/5 (order no. 9011460000) for larger wire cross-sections recommended.
- Total load-carrying capacity of the potential bridges when feeding with 1.5 mm<sup>2</sup> is max. 17.5 A (so the capacity is 2.18 A for poles 2 through 9)
- Wire end ferrule without plastic collar to DIN 46228/1
- Wire end ferrule with plastic collar to DIN 46228/4
- Conductor < 0.2 mm<sup>2</sup> tinned
- Max. outer diameter of the conductor: 2.9 mm
- Rated data refer only to the component itself. Clearance and creepage distances to other components are to be designed in accordance with the relevant application standards.
- LED operating voltage: 10 - 30V; LED operating current: 0.8mA at 24V

BL-I/O 3.50/10/180F PNP LED

with screw flange



Dimensioned drawing

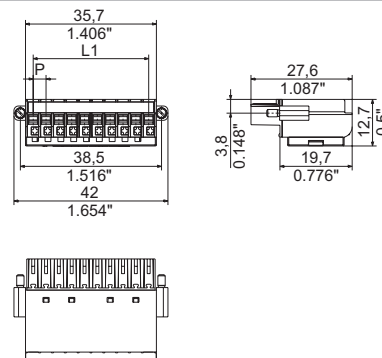

Ordering data

<b>Solder pin length</b>					
<b>Colour</b>	Light Grey		Black		
<b>Pitch</b>	<b>3.50 mm</b>				
<b>Pol.</b>	<b>L1</b>	<b>(inch)</b>	<b>Qty.</b>	<b>Order No.</b>	<b>Order No.</b>
10	31.50	1.240	20	1965940000	1789090000

Accessories

Note: Refer to the Accessories chapter for additional accessories.

<b>Coding</b>		<b>Order No.</b>
	BL SL 3.5 KO OR	1693430000
	BL SL 3.5 KO SW	1610100000
<b>Screwdriver</b>		
	SDS 0.4X2.5X75	9009030000
	SDIS 0.4X2.5X75	9008370000
<b>Crimping tool</b>		
	PZ 6/5	9011460000
	PZ 1.5	9005990000

LED series resistors designed for 24 V

Representative deratings curve

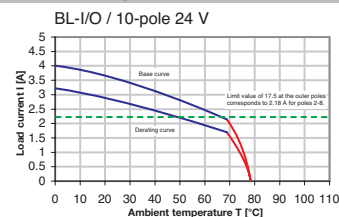

LED series resistors designed for 24 V

### BL-I/O 3.50/10/180LR PNP LED

with release latch



Dimensioned drawing

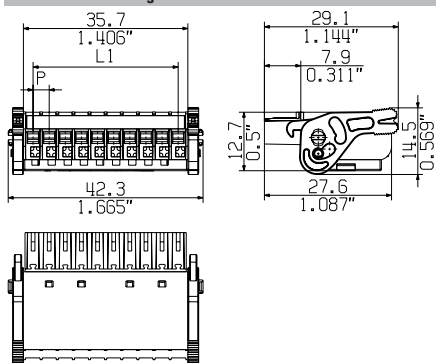

#### Ordering data

Solder pin length				
Colour				Black
Pitch 3.50 mm				
Pol.	L1	(inch)	Qty.	Order No.
10	31.50	1.240	20	1531190000

### BL-I/O 3.50/30/180F PNP LED

with screw flange



Dimensioned drawing

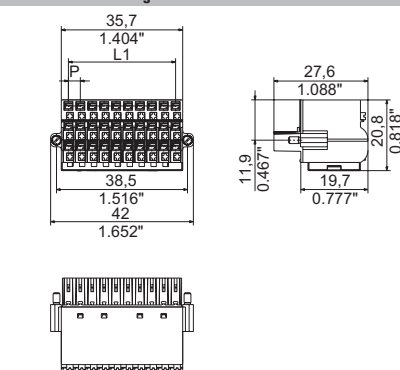

#### Ordering data

Solder pin length					
Colour				Light Grey	Black
Pitch 3.50 mm					
Pol.	L1	(inch)	Qty.	Order No.	Order No.
30	31.50	1.240	20	1965970000	1789110000

### BL-I/O 3.50/30/180LR PNP LED

with release latch



Dimensioned drawing

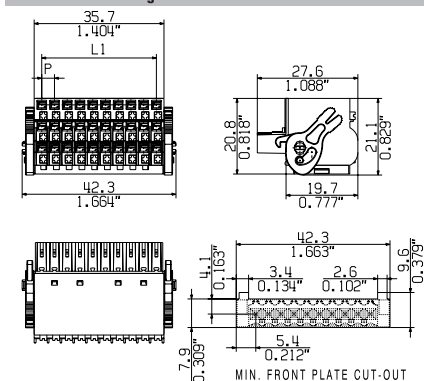

#### Ordering data

Solder pin length				
Colour				Black
Pitch 3.50 mm				
Pol.	L1	(inch)	Qty.	Order No.
30	31.50	1.240	20	1000570000

LED series resistors configured for 24V; compatible with SL-SMT 3.50 / / 90RF

LED series resistors designed for 24 V

LED series resistors designed for 24 V

#### Additional deratings curves

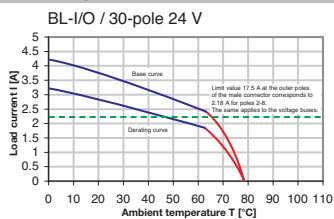

## Connectors in 3.50 mm pitch Series BL/SL 3.50

### BL-I/O 3.50/./180 NPN LED

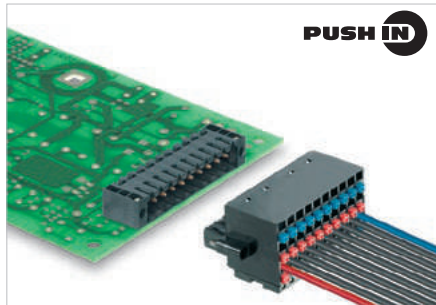

Female plug provides pluggable connection level with common positive (NPN sensor) for decentralized I/O electronics with integrated LED display; used together with male headers in 3.5 mm pitch. Available with a screw flange (F) or a lock an release lever (LR).

### Technical data

In compliance with IEC 60664-1 / IEC 61984			
Clamping range, max.	mm <sup>2</sup>	0.2...1.5	
<b>Solid core H05(07) V-U</b>	<b>mm<sup>2</sup></b>	<b>0.2...1.5</b>	
Stranded H07 V-R			
Flexible H05(07) V-K	mm <sup>2</sup>	0.2...1.5	
Flexible with ferrule	mm <sup>2</sup>	0.2...1	
Ferrule with plastic collar	mm <sup>2</sup>	0.2...0.75	
Stripping length	mm	8	
Screwdriver blade	mm	0.4 x 2.5	
According to norm			
Tightening torque range			
<b>Rated current, max.</b>	<b>A</b>	<b>2.2</b>	<b>2.2</b>
At ambient temperature		20°C	40°C
For conductor cross-section	mm <sup>2</sup>	1	
Overvoltage category		III	III II
Pollution severity		3	2 2
<b>Rated voltage</b>		<b>50</b>	
Rated impulse voltage		0.8	
<b>UL / CUL (Use Group)</b>		<b>B</b>	<b>C D</b>
<b>Rated voltage</b>	<b>V</b>	<b>50</b>	<b>50</b>
<b>Rated current</b>	<b>A</b>	<b>5</b>	<b>5</b>
<b>AWG conductor</b>	<b>AWG</b>	<b>24-16</b>	
<b>CSA (Use Group)</b>		<b>B</b>	<b>C D</b>
Rated voltage	V	50	50
Rated current	A	5	5
AWG conductor	AWG	22-16	
General data			
Type of insulation material		PBT	
UL 94 flammability rating		V-0	
Contact base material		Copper alloy	
Material of contact surface		tinned	
Pin dimensions = d	mm		
Solder eyelet Ø = D	mm		
Solder eyelet Ø tolerance	mm		

### Product data

IEC: / 2.2 A / 0.2 - 1.5 mm<sup>2</sup>  
UL: 50 V / 5 A / AWG 24 - 16



For additional articles and information, refer to [catalog.weidmueller.com](http://catalog.weidmueller.com)

#### Note:

- Additional colours on request
- P on drawing = pitch
- Crimp form A for wire end ferrules with PZ 6/5 crimping tool are recommended for the largest cable sizes.
- Total load-carrying capacity of the potential bridges when feeding with 1.5 mm<sup>2</sup> is max. 17.5 A (so the capacity is 2.18 A for poles 2 through 9)
- Wire end ferrule without plastic collar to DIN 46228/1
- Wire end ferrule with plastic collar to DIN 46228/4
- Conductor < 0.2 mm<sup>2</sup> tinned
- Max. outer diameter of the conductor: 2.9 mm
- Rated data refer only to the component itself. Clearance and creepage distances to other components are to be designed in accordance with the relevant application standards.
- LED operating voltage: 10 - 30V; LED operating current: 0.8mA at 24V

### BL-I/O 3.50/10/180F NPN LED

with screw flange



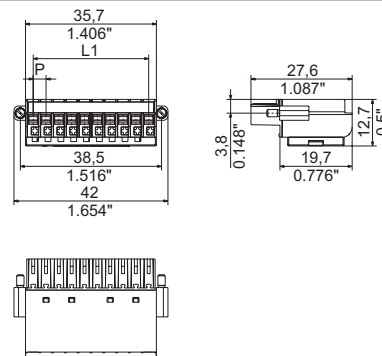

#### Dimensioned drawing



### Accessories

Note: Refer to the Accessories chapter for additional accessories.

Coding		Order No.
	BL SL 3.5 KO OR	1693430000
	BL SL 3.5 KO SW	1610100000
Screwdriver		
	SDS 0.4X2.5X75	9009030000
	SDIS 0.4X2.5X75	9008370000
Crimping tool		
	PZ 6/5	9011460000
	PZ 1.5	9005990000

### Ordering data

Solder pin length				
Colour	Black			
Pitch	3.50 mm			
Pol.	L1	(inch)	Qty.	Order No.
10	31.50	1.240	20	1938010000

LED series resistors designed for 24 V

#### Representative deratings curve

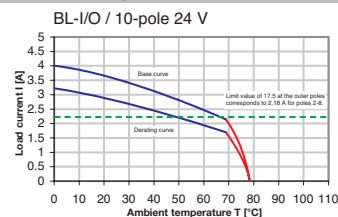

LED series resistors designed for 24 V

### BL-I/O 3.50/10/180LR NPN LED

with release latch



Dimensioned drawing

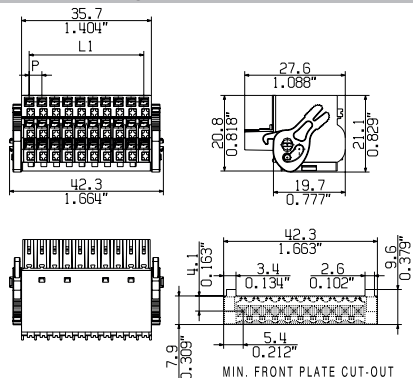

#### Ordering data

Solder pin length				
Colour	Black			
Pitch	3.50 mm			
Pol.	L1	(inch)	Qty.	Order No.
10	31.50	1.240	20	1531200000

### BL-I/O 3.50/30/180F NPN LED

with screw flange



Dimensioned drawing

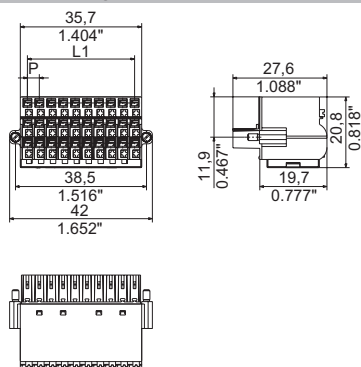

#### Ordering data

Solder pin length				
Colour	Black			
Pitch	3.50 mm			
Pol.	L1	(inch)	Qty.	Order No.
30	31.50	1.240	20	1938020000

### BL-I/O 3.50/30/180LR NPN LED

with release latch



Dimensioned drawing

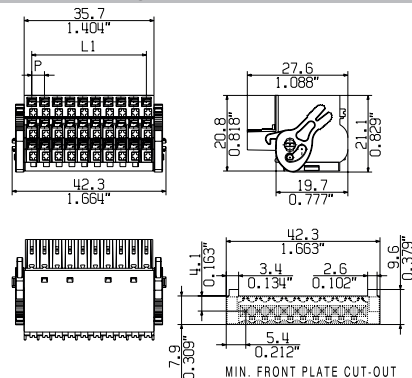

#### Ordering data

Solder pin length				
Colour	Black			
Pitch	3.50 mm			
Pol.	L1	(inch)	Qty.	Order No.
30	31.50	1.240	20	1000590000

LED series resistors configured for 24V; compatible with SL-SMT 3.50 / ./ 90RF

LED series resistors designed for 24 V

LED series resistors designed for 24 V

#### Additional deratings curves

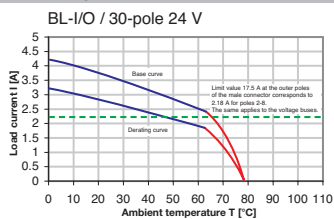

BL I/O 3.50../180 CJC



Many industrial applications demand an increasingly higher accuracy of temperature measurement. At the same time, the required equipment must become cheaper and smaller. For the BL I/O 3.5 CJC, the cold junction compensation is integrated into the connector, which reduces space and costs.

The cold junction compensation of the BL I/O 3.5 CJC is integrated by a thermistor in the connector. Therefore, no additional compensation is needed when connecting thermocouples to a device to measure the temperature. The integrated compensation simplifies the device and increases the measuring accuracy up to 20%.

Technical data

In compliance with IEC 60664-1 / IEC 61984			
Clamping range, max.	mm <sup>2</sup>	0.2...1.5	
<b>Solid core H05(07) V-U</b>	<b>mm<sup>2</sup></b>	<b>0.2...1.5</b>	
Stranded H07 V-R			
Flexible H05(07) V-K	mm <sup>2</sup>	0.2...1.5	
Flexible with ferrule	mm <sup>2</sup>	0.2...1	
Ferrule with plastic collar	mm <sup>2</sup>	0.2...0.75	
Stripping length	mm	8	
Screwdriver blade	mm	0.4 x 2.5	
		According to norm	
Tightening torque range			
<b>Rated current, max.</b>	<b>A</b>	<b>2.2</b>	<b>2.2</b>
At ambient temperature		20°C	40°C
For conductor cross-section	mm <sup>2</sup>	1	
Overvoltage category		III	III II
Pollution severity		3	2 2
<b>Rated voltage</b>		<b>50</b>	
Rated impulse voltage		0.8	
<b>UL / CUL (Use Group)</b>		<b>B</b>	<b>C D</b>
<b>Rated voltage</b>	<b>V</b>	<b>50</b>	<b>50</b>
<b>Rated current</b>	<b>A</b>	<b>5</b>	<b>5</b>
<b>AWG conductor</b>	<b>AWG</b>	<b>24-16</b>	
<b>CSA (Use Group)</b>		<b>B</b>	<b>C D</b>
Rated voltage	V	50	50
Rated current	A	5	5
AWG conductor	AWG	22-16	
<b>General data</b>			
Type of insulation material		PBT	
UL 94 flammability rating			
Contact base material		Copper alloy	
Material of contact surface		Gold-plated	
Pin dimensions = d	mm		
Solder eyelet Ø = D			
Solder eyelet Ø tolerance	mm		

Product data

IEC: / 2.2 A / 0.2 - 1.5 mm<sup>2</sup>  
UL: 50 V / 5 A / AWG 24 - 16



For additional articles and information, refer to [catalog.weidmueller.com](http://catalog.weidmueller.com)

Note:

- Additional colours on request
- P on drawing = pitch
- Crimp form A for wire end ferrules with PZ 6/5 crimping tool are recommended for the largest cable sizes.
- Total load-carrying capacity of the potential bridges when feeding with 1.5 mm<sup>2</sup> is max. 17.5 A (so the capacity is 2.18 A for poles 2 through 9)
- Wire end ferrule without plastic collar to DIN 46228/1
- Wire end ferrule with plastic collar to DIN 46228/4
- Conductor < 0.2 mm<sup>2</sup> tinned
- Max. outer diameter of the conductor: 2.9 mm
- Rated data refer only to the component itself. Clearance and creepage distances to other components are to be designed in accordance with the relevant application standards.

BL I/O 3.5 CJC



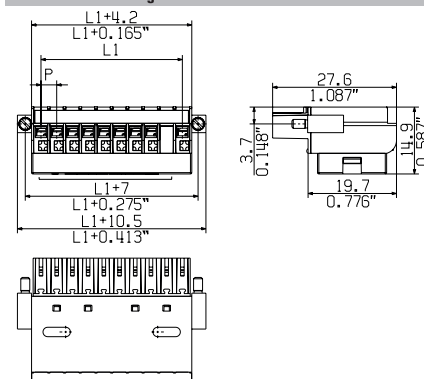

Dimensioned drawing



Accessories

Note: Refer to the Accessories chapter for additional accessories.

Coding		Order No.
	BL SL 3.5 KO OR	1693430000
	BL SL 3.5 KO SW	1610100000
Screwdriver		
	SDS 0.4X2.5X75	9009030000
	SDIS 0.4X2.5X75	9008370000
Crimping tool		
	PZ 6/5	9011460000
	PZ 1.5	9005990000

Ordering data

Solder pin length				
Colour				Black
Pitch	3.50 mm			
Pol.	L1	(inch)	Qty.	Order No.
10	31.50	1.240	20	2471390000

### BL-I/O 3.50/./180

#### BL-I/O 3.5 30-pin

- Pluggable connection terminals for remote I/O electronics
- Directly from the control or industrial PC etc. to the sensor or actuator level
- Significant space savings as well as savings in design time and wiring.

### BL-I/O 3.50/./180 PNP LED

#### BL-I/O 3.5 30-pin

- Pluggable connection terminals for remote I/O electronics
- Directly from the control or industrial PC etc. to the sensor or actuator level
- Significant space savings as well as savings in design time and wiring.

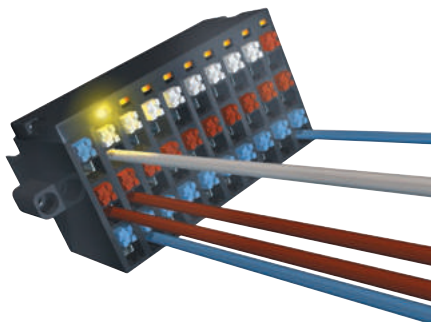

### BL-I/O 3.50/./180 NPN LED

#### BL-I/O 3.5 30-pin

- Pluggable connection terminals for remote I/O electronics
- Directly from the control or industrial PC etc. to the sensor or actuator level
- Significant space savings as well as savings in design time and wiring.

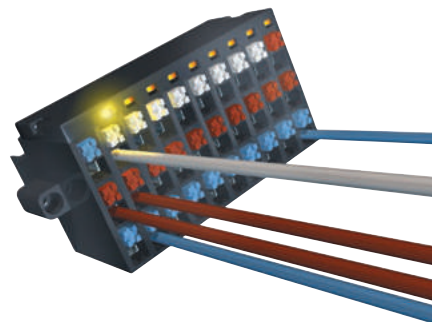

#### Integrated LED version

- Available for all the BL-I/Os
- Test the sensor or actuator cabling before commissioning the controller
- Eliminates the need for function displays in the housing

#### Integrated LED version

- Available for all the BL-I/Os
- Test the sensor or actuator cabling before commissioning the controller
- Eliminates the need for function displays in the housing

#### Diagram of BL-I/O 30 pin with SL 3.5 10 pin

- Direct connection possibilities for sensors and actuators including their power supply
- Can be used for external or internal power supply sources

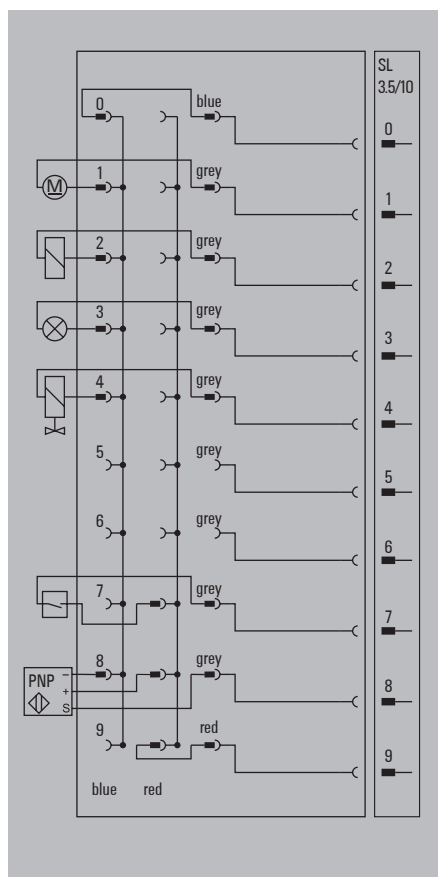

#### Diagram of BL-I/O 30 pin with SL 3.5 10 pin

- Direct connection possibilities for sensors and actuators including their power supply
- Can be used for external or internal power supply sources

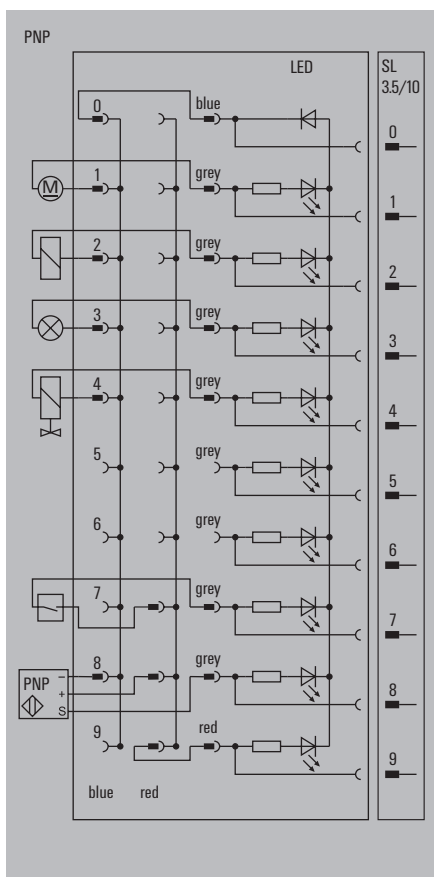

#### Diagram of BL-I/O 30 pin with SL 3.5 10 pin

- Direct connection possibilities for sensors and actuators including their power supply
- Can be used for external or internal power supply sources

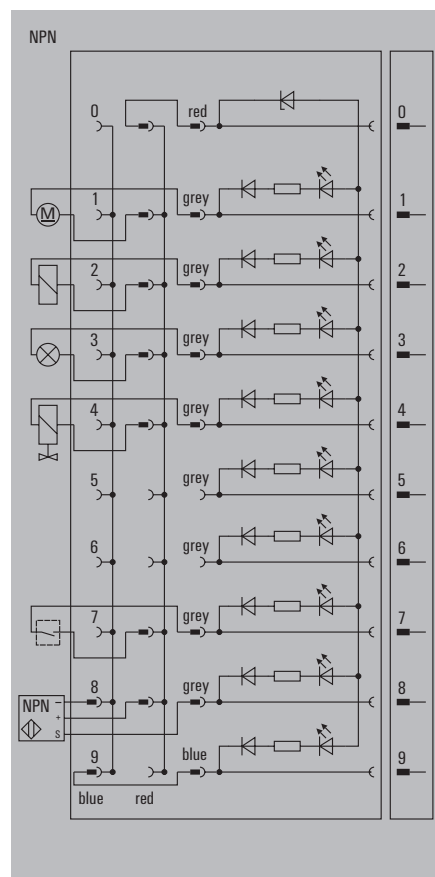

## Connectors in 3.50 mm pitch Series BL/SL 3.50

### BLL 3.50/./180

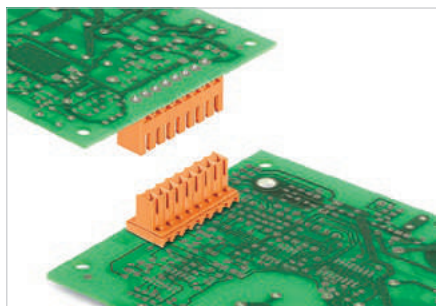

Inverted female headers for:

- touch-safety on the PCB
- board-to-board connection of modules (with SL/SL-SMT)
- Wave soldering
- Outlet direction: 180° (standing, perpendicular to PCB)

### Technical data

In compliance with IEC 60664-1 / IEC 61984

Clamping range, max.			
<b>Solid core H05(07) V-U</b>			
Stranded H07 V-R			
Flexible H05(07) V-K			
Flexible with ferrule			
Ferrule with plastic collar			
Stripping length			
Screwdriver blade	mm		
According to norm			
Tightening torque range			
<b>Rated current, max.</b>	<b>A</b>	<b>15.1</b>	<b>13</b>
At ambient temperature		20°C	40°C
For conductor cross-section			
Overtolerance category		III	III
Pollution severity		3	2
<b>Rated voltage</b>	<b>V</b>	<b>160</b>	<b>160 320</b>
Rated impulse voltage	kV	2.5	2.5 2.5
<b>UL / CUL (Use Group)</b>	<b>B C D</b>		
<b>Rated voltage</b>	<b>V</b>	<b>300</b>	<b>300</b>
<b>Rated current</b>	<b>A</b>	<b>9</b>	<b>9</b>
<b>AWG conductor</b>	<b>AWG</b>		
<b>CSA (Use Group)</b>	<b>B C D</b>		
Rated voltage	V	300	
Rated current	A	9	
AWG conductor	AWG	-	
<b>General data</b>			
Type of insulation material		PBT	
UL 94 flammability rating		V-0	
Contact base material		CuSn	
Material of contact surface		tinned	
Pin dimensions = d	mm	0.8	
Solder eyelet Ø = D	mm	1.3	
Solder eyelet Ø tolerance	mm	+ 0,1	

### Product data

IEC: 320 V / 15.1 A

UL: 300 V / 9 A



For additional articles and information, refer to [catalog.weidmuller.com](http://catalog.weidmuller.com)

#### Note:

- Additional colours on request
- Gold-plated contact surfaces on request
- Rated current related to rated cross-section & min. No. of poles.
- P on drawing = pitch
- Rated data refer only to the component itself. Clearance and creepage distances to other components are to be designed in accordance with the relevant application standards.

### BLL 3.50/./180



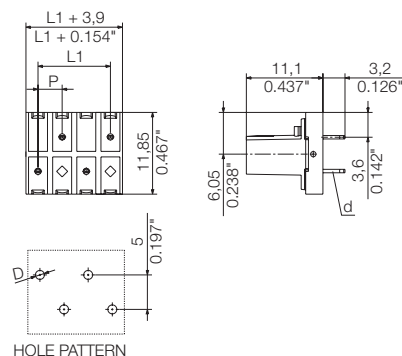

#### Dimensioned drawing



HOLE PATTERN

### Accessories

Note: Refer to the Accessories chapter for additional accessories.

Coding		Order No.
	BL SL 3.5 KO OR	1693430000
	BL SL 3.5 KO SW	1610100000

### Ordering data

Solder pin length		3.2 mm		
Colour		Orange		
Pitch		3.50 mm		
Pol.	L1	(inch)	Qty.	Order No.
2	3.50	0.138	75	1376310000
3	7.00	0.276	50	1376320000
4	10.50	0.413	38	1376330000
5	14.00	0.551	30	1376340000
6	17.50	0.689	25	1376430000
7	21.00	0.827	22	1376350000
8	24.50	0.965	19	1376440000
9	28.00	1.102	17	1376450000
10	31.50	1.240	15	1376470000
11	35.00	1.378	14	1376370000
12	38.50	1.516	13	1376480000

### Representative deratings curve

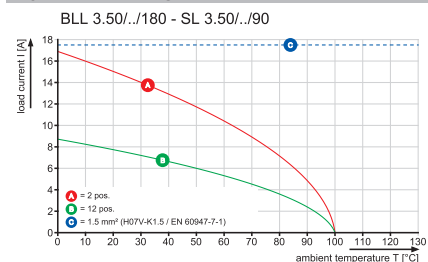



# OMNIMATE® Signal PCB connectors in 3.81 mm pitch

**OMNIMATE® Signal**  
**PCB connectors in 3.81 mm pitch**

Connectors in 3.81 mm pitch  
Series BC/SC 3.81

Explanation	F.2
Quick selection	F.6
Product selection	F.8

# Plug-in connector OMNIMATE® Signal 3.81

## Opens up new dimensions for your application

### Large variety of products and an extensive accessory range

- All combinations are possible: wire-to-board, wire-to-wire, board-to-board, board-to-wire
- Wide range of reflow ready strips
- Individually configurable with accessories and specific printing or coding
- Compact design to connect 1.5 mm<sup>2</sup> wires

### Unique performance offering high levels of redundancy

- Rated current: 17.5 A
- Up to 65 °C without derating
- Ambient temperature up to 120 °C

### Safe handling characteristics

- Lock & Release lever allows tool-free locking and module-safe loosening
- Vibration resistant PUSH IN connection offers tool free wiring connection
- Proven screw connection

### Simple handling

Reliable flange connections are easy to use and protect the electronic modules when they are removed: screw flange, release lever or lock & release lever.



### Unique performance

High power reserves allow applications without restrictions up to the maximum wiring power rating - even in high ambient temperatures.

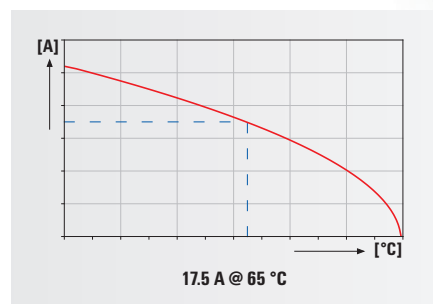

**Less space required**

Minimum stack height, maximum clamping force and PUSH IN: the SCDN 3.81 simply handles two 7.9 mm flat BCF 3.81 with 1.5 mm<sup>2</sup> wire end ferrules.

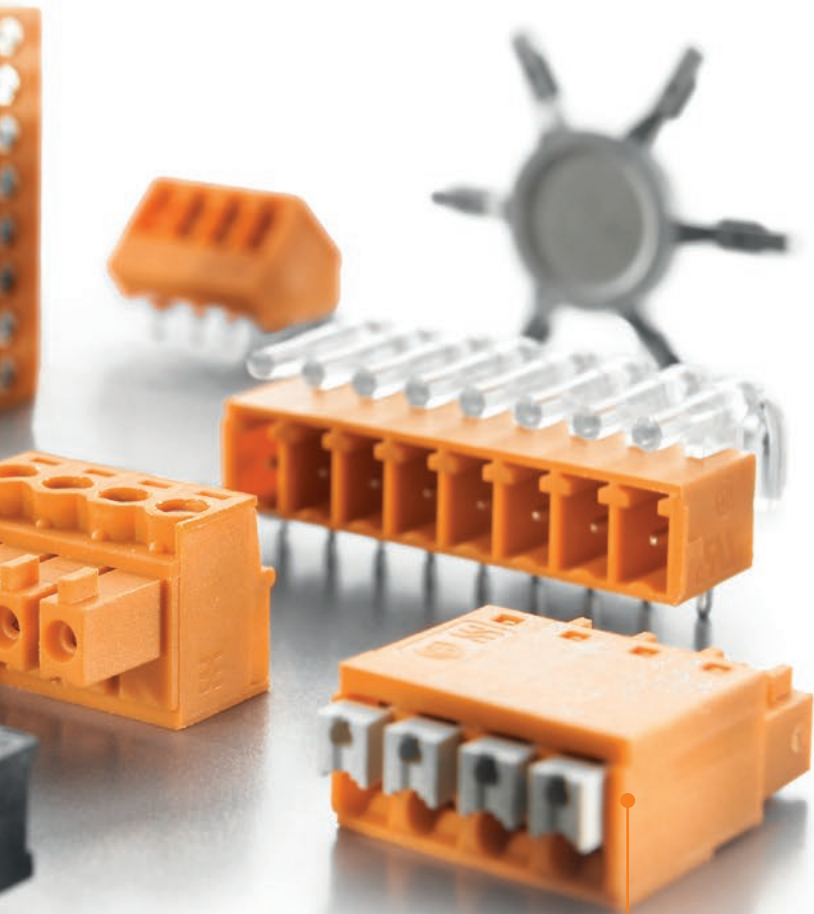

**Maintenance-free, secure, vibration-proof**

PUSH IN spring connection technology: direct connection without tools – simply plug in the prepared conductors – finished! Intuitive operation using large release buttons.

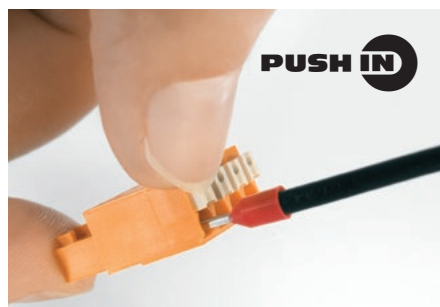

**Complete system for all possible combinations and a comprehensive range of accessories**

**Wire-to-Board**

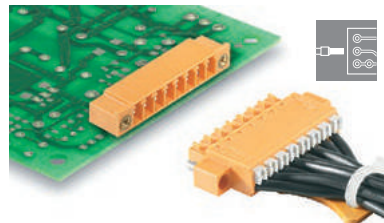

**Wire-to-Wire**

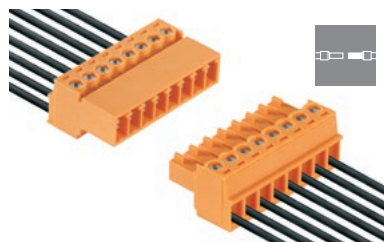

**Board-to-Board**

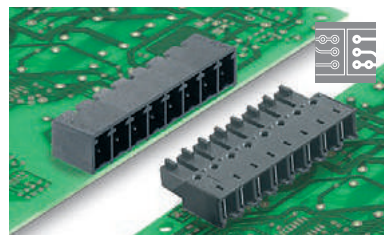

**Board-to-Wire**

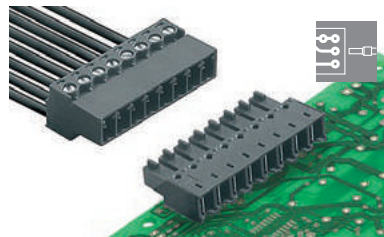

**Accessories**

Coding SC-SMT KO GR      Light guide display SC FLA      Cover hood BCZ AH



# Plug-in connector OMNIMATE® Signal 3.81

## Brings new dimensions into handling

### Best choice for reflow soldering

- Reflow strips made from the high temperature material LCP
- Form at high soldering temperatures stability
- Dimensionally stable
- Can be processed without drying (MSL 1)
- Thermal expansion properties similar to a FR4 PCB

### Unique handling

- Suitable for automatic machine handling, antistatic packaging in tape, tray or tube
- Optional Pick & Place pad supports feeder systems
- Solder flange fixes the strip to the PCB without the use of screws
- An optimised pin end which permits AOI (automated optical inspection)
- Variable pin length to support placement on both sides of the PCB
- Integrated spacing bars improve the flow of heat during the solder process
- Free space in the pin area facilitate the development of the solder meniscus.

### Packaging suitable for use in automated assembly

Standard belt widths for simple integration into the assembly process.



### Code in advance – process universally

No additional work required for factory-side reflow-compatible coding.

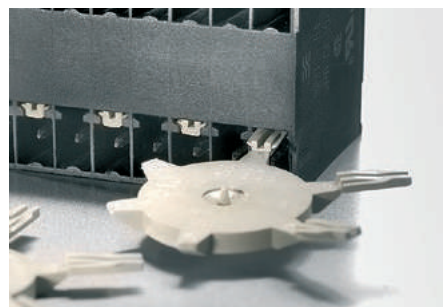

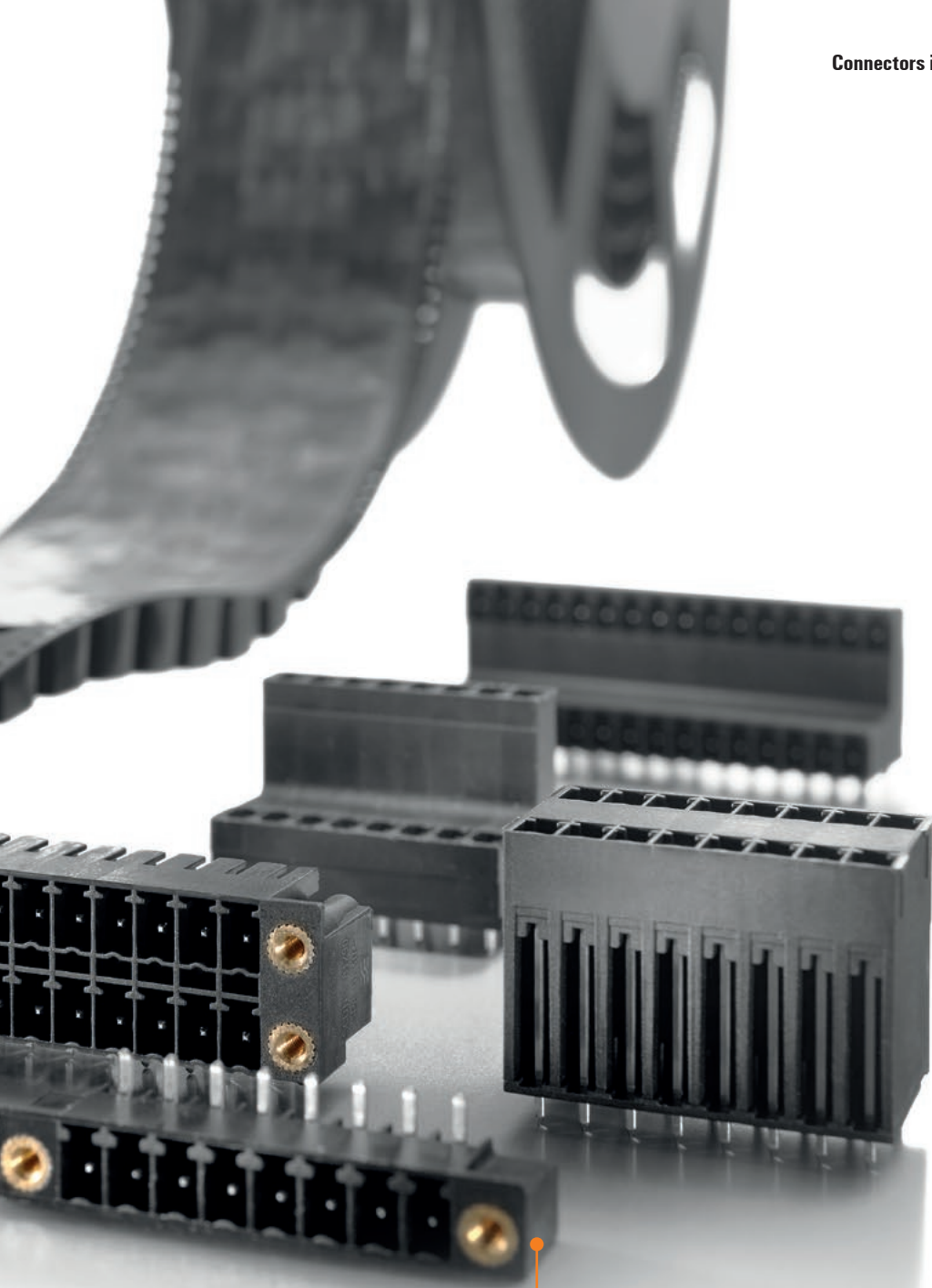

**Solder flange pin**  
Secures to the PCB without a screw

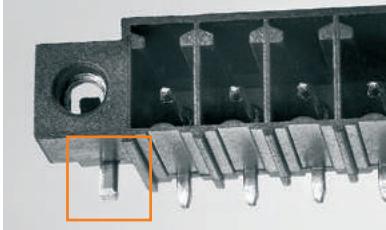

**Integrated bars**  
Optimal airflow during reflow soldering

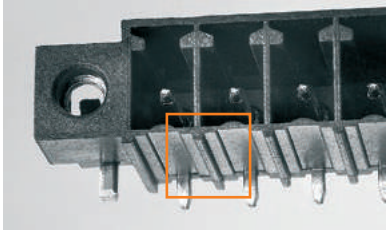

**Rebates in the area of the pin**  
Space for the development of the solder meniscus

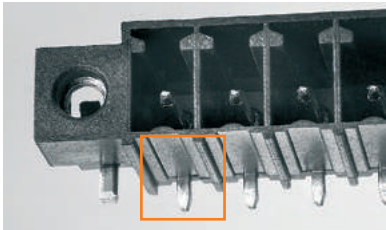

**Pin tips**  
Optimal recognition by the automatic optical inspection device (AOI)

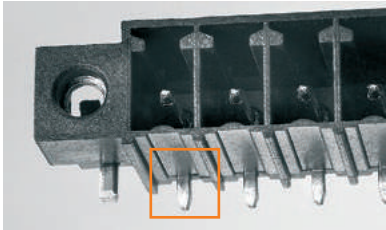



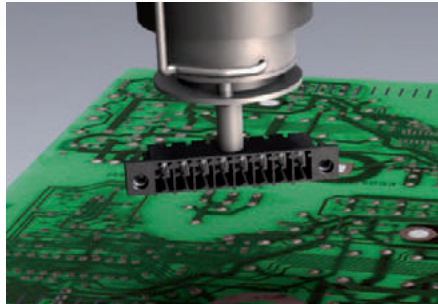

F

**SMT**  
No need for pre-treatment, high temperature material LCP is safe to use during the soldering process.



<http://www.OMNIMATE.net>

-  = Wire-to-Board
-  = Board-to-Board
-  = Wire-to-Wire
-  = Board-to-Wire

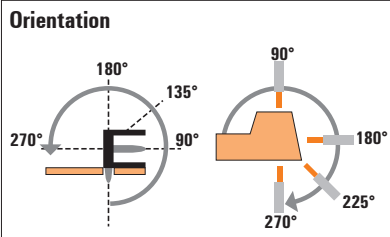
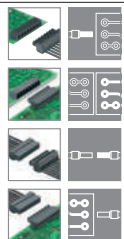



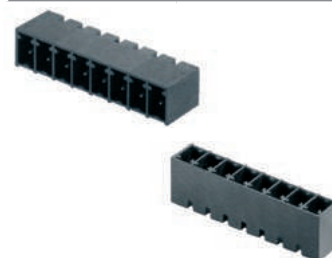



Male header



BC/SC 3.81 series



F

		Levels		1	
Orientation		90°	180°		
IEC / UL		IEC: 320 V/17.5 A UL: 300 V/10 A	IEC: 320 V/17.5 A UL: 300 V/10 A		
Type		Solder connection			
Flange options		SC	SC		
		G/F	G/F		
		Reflow solder connection			
Type		SC-SMT	SC-SMT		
Flange options		G/LF	G/LF		
Female plug	Screw	 <b>BCZ</b> 180° (G)/F/LR IEC: 320 V/17.5 A/0.2 - 1.5 mm <sup>2</sup> UL: 300 V/10 A/AWG 28 - 16	 <b>BCZ</b> 90° (G)/F IEC: 320 V/17.5 A/0.2 - 1.5 mm <sup>2</sup> UL: 300 V/10 A/AWG 28 - 16	 <b>BCZ</b> 270° (G)/F IEC: 320 V/17.5 A/0.2 - 1.5 mm <sup>2</sup> UL: 300 V/10 A/AWG 28 - 16	
		 <b>BCF</b> 180° (G)/F/LR IEC: 320 V/17.5 A/0.14 - 1.5 mm <sup>2</sup> UL: 300 V/10 A/AWG 24 - 16			
		Female header	Solder connection	 <b>BCL SMT</b> 90° (G)/F/LFI IEC: 320 V/17.5 A UL: 300 V/10 A	 <b>BCL SMT</b> 180° (G)/LFI IEC: 320 V/17.5 A UL: 300 V/10 A

**Female plug and header:**  
**(G)\*** = Closed (without flange)  
**F** = Flange with screw  
**LFI** = Inverted solder flange with nut  
**LR** = Lock & Release lever

**Male header and plug:**  
**G** = Closed (without flange)  
**F** = Screw flange with nut  
**LF** = Solder flange with nut  
**LR** = Lock & Release lever  
**FI** = Inverted flange with screw

\* not included in the article description

**Male header** **Male plug**

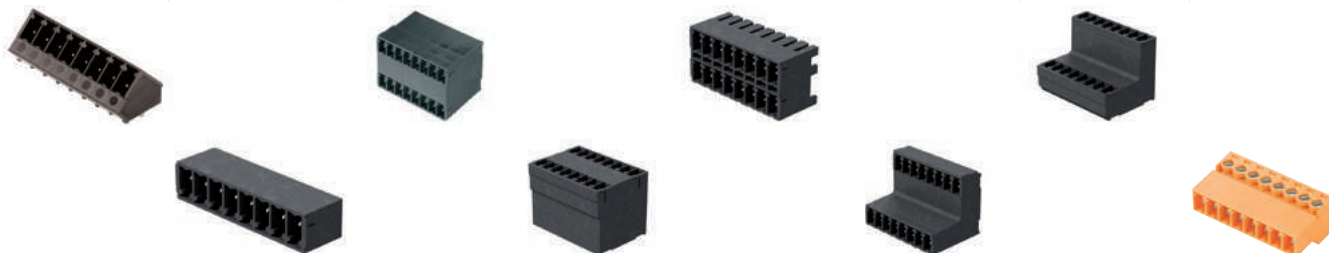

1		2					1
135°	270°	90°	180°	90°	90°	180°	180°
IEC: 320 V/17.5 A UL: 300 V/10 A	IEC: 320 V/17.5 A UL: 300 V/10 A	IEC: 320 V/17.5 A UL: 300 V/10 A	IEC: 320 V/17.5 A UL: 300 V/10 A	IEC: 320 V/17.5 A UL: 300 V/10 A	IEC: 320 V/17.5 A UL: 300 V/10 A	IEC: 320 V/17.5 A UL: 300 V/10 A	IEC: 320 V/17.5 A/ 0.2 - 1.5 mm <sup>2</sup> UL: 300 V/10 A/ AWG 28 - 16

  
**Solder connection**

  
**Screw**

SC	SC	SCD	SCD	SCDN	SCDV	SCDV	SCZ
G/F	G/F	G/F	G/F	G/F	G/F	G/F	G/F/Fl/LR

  
**Reflow solder connection**

SC-SMT	SC-SMT	SCD-THR	SCD-THR	SCDN-THR	SCDV-THR	SCDV-THR	
G/LF	G/F	G/F	G/F	G/F	G/F	G/F	
○	○	○	○		○	○	●
○	○	○	○		○	○	●
○	○	○	○		○	○	●
○	○	○	○	○	○	○	●
●	●	●	●	●	●	●	●
●	●	●	●	●	●	●	●

**F**

## Connectors in 3.81 mm pitch Series BC/SC 3.81

### SC-SMT 3.81/./90

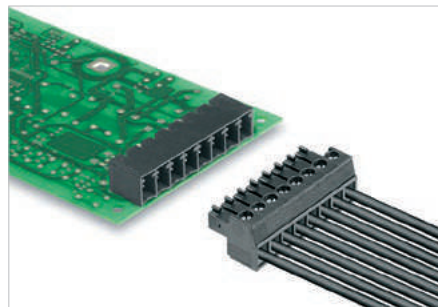

High-temperature-resistant male header.

- Plugging direction parallel to PCB
- Available in closed (G) and with solder flange (LF).
- Packed either in box (BX) or on anti-static roll (tape-on-reel, RL)
- Pin length of either 1.5 mm or 3.2 mm

Weidmüller's 3.81 mm pitch (0.15 inch) plug-in connectors are compatible with the layouts of standard connectors and offer space for labelling and coding.

### Product data

IEC: 320 V / 17.5 A  
UL: 300 V / 10 A



For additional articles and information, refer to [catalog.weidmueller.com](http://catalog.weidmueller.com)

#### Note:

- Rated current related to rated cross-section & min. No. of poles.
- Rated data refer only to the component itself. Clearance and creepage distances to other components are to be designed in accordance with the relevant application standards.
- P on drawing = pitch

### SC-SMT 3.81/./90G Box

closed side

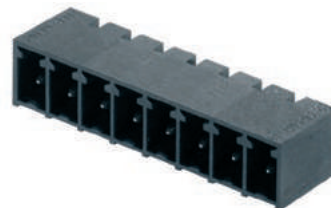

#### Dimensioned drawing

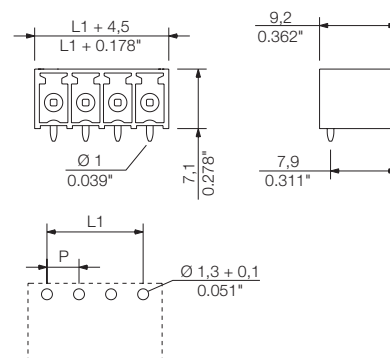

### Technical data

In compliance with IEC 60664-1 / IEC 61984

Clamping range, max.			
<b>Solid core H05(07) V-U</b>			
Stranded H07 V-R			
Flexible H05(07) V-K			
Flexible with ferrule			
Ferrule with plastic collar			
Stripping length			
Screwdriver blade	mm		
According to norm			
Tightening torque range			
<b>Rated current, max.</b>	<b>A</b>	<b>17.5</b>	<b>17</b>
At ambient temperature		20°C	40°C
For conductor cross-section			
Overvoltage category		III	III II
Pollution severity		3	2 2
<b>Rated voltage</b>	<b>V</b>	<b>160</b>	<b>160 320</b>
Rated impulse voltage	kV	2.5	2.5 2.5
<b>UL / CUL (Use Group)</b>		<b>B</b>	<b>C D</b>
<b>Rated voltage</b>	<b>V</b>	<b>300</b>	<b>300</b>
<b>Rated current</b>	<b>A</b>	<b>10</b>	<b>10</b>
<b>AWG conductor</b>	<b>AWG</b>		-
<b>CSA (Use Group)</b>		<b>B</b>	<b>C D</b>
Rated voltage	V	300	
Rated current	A	8	
AWG conductor	AWG		-
<b>General data</b>			
Type of insulation material		LCP GF	
UL 94 flammability rating		V-0	
Contact base material		Copper alloy	
Material of contact surface		tinned	
Pin dimensions = d	mm	1.0, Octagonal	
Solder eyelet Ø = D	mm	1.3	
Solder eyelet Ø tolerance	mm	+ 0,1	

### Accessories

Note: Refer to the Accessories chapter for additional accessories.

Coding	Order No.
SC-SMT 3.81 KO GY BX	1968900000

### Ordering data

Solder pin length		3.2 mm		
Colour		Black		
Pitch	3.81 mm			
Pol.	L1	(inch)	Qty.	Order No.
2	3.81	0.150	50	1862460000
3	7.62	0.300	50	1862480000
4	11.43	0.450	50	1862490000
5	15.24	0.600	50	1862500000
6	19.05	0.750	50	1862510000
7	22.86	0.900	50	1862520000
8	26.67	1.050	50	1862530000
9	30.48	1.200	50	1862540000
10	34.29	1.350	50	1862550000
11	38.10	1.500	50	1862570000
12	41.91	1.650	50	1862730000
13	45.72	1.800	50	1862740000
14	49.53	1.950	50	1862760000
15	53.34	2.100	50	1862780000
16	57.15	2.250	50	1862800000

3.81

90°



### SC-SMT 3.81/./90G Tape

closed side; tape-on-reel

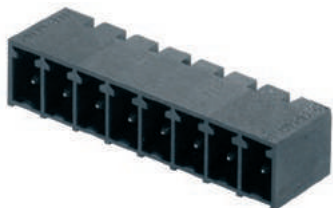

Dimensioned drawing

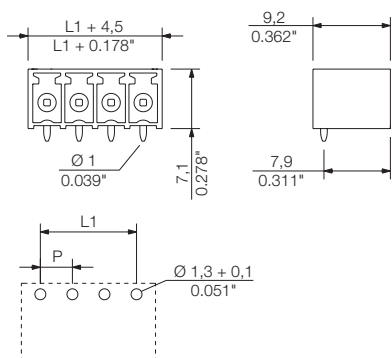

#### Ordering data

Solder pin length		1.5 mm	
Colour		Black	
Pitch		3.81 mm	
Pol.	L1	(inch)	Qty. Order No.
2	3.81	0.150	400 1863140000
3	7.62	0.300	400 1863150000
4	11.43	0.450	400 1863160000
5	15.24	0.600	400 1863170000
6	19.05	0.750	400 1863180000
7	22.86	0.900	400 1863190000
8	26.67	1.050	400 1863200000
9	30.48	1.200	400 1863210000
10	34.29	1.350	400 1863220000

Tape widths: 32, 44, 56, 72, 88

### SC-SMT 3.81/./90LF Box

with solder flange

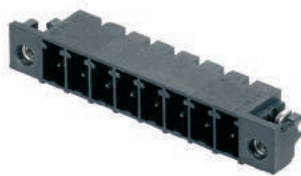

Dimensioned drawing

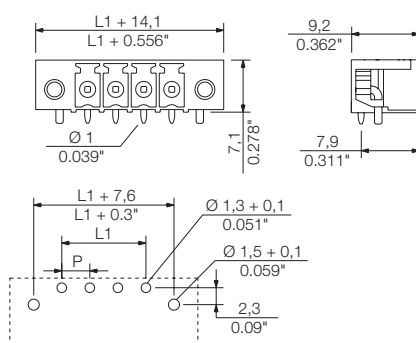

#### Ordering data

Solder pin length		3.2 mm	
Colour		Black	
Pitch		3.81 mm	
Pol.	L1	(inch)	Qty. Order No.
2	3.81	0.150	50 1863670000
3	7.62	0.300	50 1863680000
4	11.43	0.450	50 1863690000
5	15.24	0.600	50 1863700000
6	19.05	0.750	50 1863710000
7	22.86	0.900	50 1863740000
8	26.67	1.050	50 1863760000
9	30.48	1.200	50 1863770000
10	34.29	1.350	50 1863790000
11	38.10	1.500	50 1863810000
12	41.91	1.650	50 1863820000
13	45.72	1.800	50 1863840000
14	49.53	1.950	50 1863850000
15	53.34	2.100	50 1863860000
16	57.15	2.250	50 1863870000

### SC-SMT 3.81/./90LF Tape

with solder flange; tape-on-reel



Dimensioned drawing

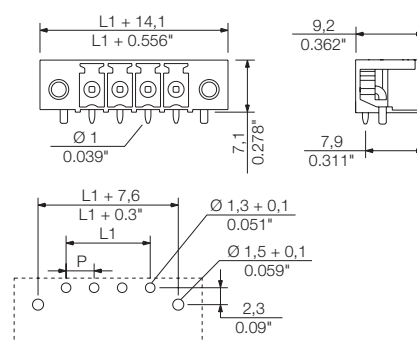

#### Ordering data

Solder pin length		1.5 mm	
Colour		Black	
Pitch		3.81 mm	
Pol.	L1	(inch)	Qty. Order No.
2	3.81	0.150	400 1862720000
3	7.62	0.300	400 1862750000
4	11.43	0.450	400 1862770000
5	15.24	0.600	400 1862790000
6	19.05	0.750	400 1862820000
7	22.86	0.900	400 1862830000
8	26.67	1.050	400 1862850000

Tape widths: 32, 44, 56, 72, 88

## Connectors in 3.81 mm pitch Series BC/SC 3.81

### SC-SMT 3.81/././180

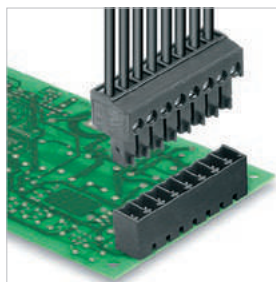

High-temperature-resistant male header.

- Plugging direction is perpendicular to PCB
- Available in closed (G) and with solder flange (LF).
- Packed either in box (BX) or on anti-static roll (tape-on-reel, RL)
- Pin length of either 1.5 mm or 3.2 mm

Weidmüller's 3.81 mm pitch (0.15 inch) plug-in connectors are compatible with the layouts of standard connectors and offer space for labelling and coding.

### Product data

IEC: 320 V / 17.5 A  
UL: 300 V / 10 A



For additional articles and information, refer to [catalog.weidmueller.com](http://catalog.weidmueller.com)

#### Note:

- Rated current related to rated cross-section & min. No. of poles.
- Rated data refer only to the component itself. Clearance and creepage distances to other components are to be designed in accordance with the relevant application standards.
- P on drawing = pitch

### SC-SMT 3.81/././180G Box

closed side



#### Dimensioned drawing

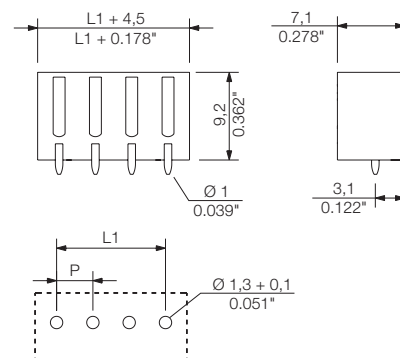

### Technical data

#### In compliance with IEC 60664-1 / IEC 61984

Clamping range, max.			
<b>Solid core H05(07) V-U</b>			
Stranded H07 V-R			
Flexible H05(07) V-K			
Flexible with ferrule			
Ferrule with plastic collar			
Stripping length			
Screwdriver blade	mm		
According to norm			
Tightening torque range			
<b>Rated current, max.</b>	<b>A</b>	<b>17.5</b>	<b>17</b>
At ambient temperature		20°C	40°C
For conductor cross-section			
Overtoltage category		III	III II
Pollution severity		3	2 2
<b>Rated voltage</b>	<b>V</b>	<b>160</b>	<b>160 320</b>
Rated impulse voltage	kV	2.5	2.5 2.5
<b>UL / CUL (Use Group)</b>		<b>B</b>	<b>C D</b>
<b>Rated voltage</b>	<b>V</b>	<b>300</b>	<b>300</b>
<b>Rated current</b>	<b>A</b>	<b>10</b>	<b>10</b>
<b>AWG conductor</b>	<b>AWG</b>		-
<b>CSA (Use Group)</b>		<b>B</b>	<b>C D</b>
Rated voltage	V	300	
Rated current	A	8	
AWG conductor	AWG		-
<b>General data</b>			
Type of insulation material		LCP GF	
UL 94 flammability rating		V-0	
Contact base material		Copper alloy	
Material of contact surface		tinned	
Pin dimensions = d	mm	1.0, Octagonal	
Solder eyelet Ø = D	mm	1.3	
Solder eyelet Ø tolerance	mm	+ 0,1	

### Accessories

Note: Refer to the Accessories chapter for additional accessories.

Coding	Order No.
SC-SMT 3.81 KO GY BX	1968900000

### Ordering data

Solder pin length		3.2 mm		
Colour		Black		
Pitch	3.81 mm			
Pol.	L1	(inch)	Qty.	Order No.
2	3.81	0.150	50	1862920000
3	7.62	0.300	50	1862940000
4	11.43	0.450	50	1862950000
5	15.24	0.600	50	1863010000
6	19.05	0.750	50	1863020000
7	22.86	0.900	50	1863030000
8	26.67	1.050	50	1863240000
9	30.48	1.200	50	1863270000
10	34.29	1.350	50	1863290000
11	38.10	1.500	50	1863320000
12	41.91	1.650	50	1863330000
13	45.72	1.800	50	1863350000
14	49.53	1.950	50	1863370000
15	53.34	2.100	50	1863400000
16	57.15	2.250	50	1863420000

3.81

180°

SC-SMT 3.81/./180G Tape

closed side; tape-on-reel



Dimensioned drawing

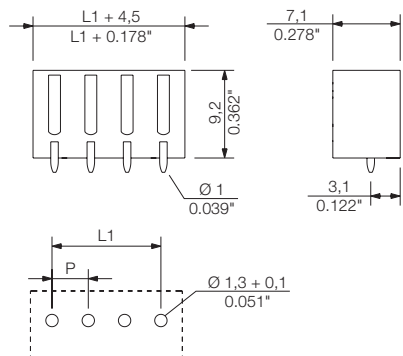

Ordering data

Solder pin length		1.5 mm	3.2 mm
Colour		Black	Black
Pitch 3.81 mm			
Pol.	L1 (inch)	Qty.	Order No.
2	3.81 0.150	300	1864050000
3	7.62 0.300	300	1864060000
4	11.43 0.450	300	1864290000 1863490000
5	15.24 0.600	300	1864300000
6	19.05 0.750	300	1864310000
7	22.86 0.900	300	1864320000
8	26.67 1.050	300	1864330000
9	30.48 1.200	300	1864340000
10	34.29 1.350	300	1864350000

Tape widths: 32, 44, 56, 72, 88

SC-SMT 3.81/./180LF Box

with solder flange



Dimensioned drawing

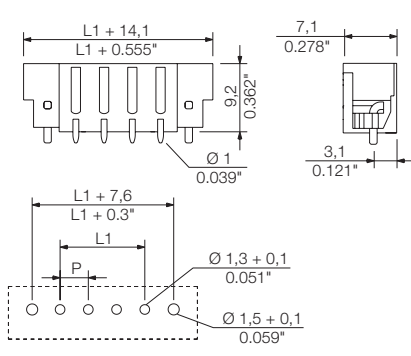

Ordering data

Solder pin length		3.2 mm	
Colour		Black	
Pitch 3.81 mm			
Pol.	L1 (inch)	Qty.	Order No.
2	3.81 0.150	50	1863230000
3	7.62 0.300	50	1863250000
4	11.43 0.450	50	1863260000
5	15.24 0.600	50	1863280000
6	19.05 0.750	50	1863300000
7	22.86 0.900	50	1863310000
8	26.67 1.050	50	1863340000
9	30.48 1.200	50	1863360000
10	34.29 1.350	50	1863380000
11	38.10 1.500	50	1863390000
12	41.91 1.650	50	1863410000
13	45.72 1.800	50	1863430000
14	49.53 1.950	50	1863440000
15	53.34 2.100	50	1863460000
16	57.15 2.250	50	1863480000

SC-SMT 3.81/./180LF Tape

with solder flange; tape-on-reel



Dimensioned drawing

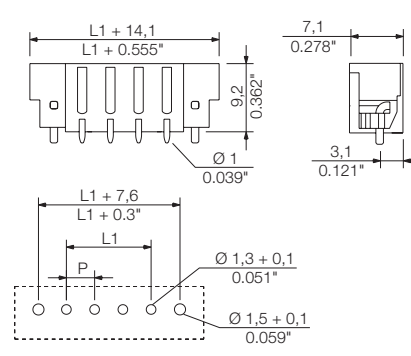

Ordering data

Solder pin length		1.5 mm	
Colour		Black	
Pitch 3.81 mm			
Pol.	L1 (inch)	Qty.	Order No.
2	3.81 0.150	300	1864220000
3	7.62 0.300	300	1864230000
4	11.43 0.450	300	1864240000
5	15.24 0.600	300	1864250000
6	19.05 0.750	300	1864260000
7	22.86 0.900	300	1864270000
8	26.67 1.050	300	1864280000

Tape widths: 32, 44, 56, 72, 88

## Connectors in 3.81 mm pitch Series BC/SC 3.81

### SC-SMT 3.81../135

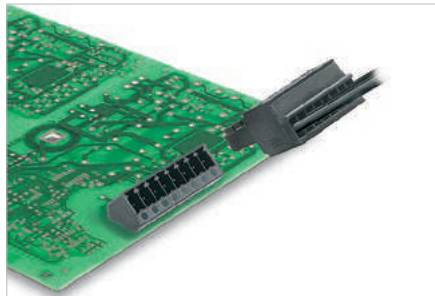

Male header with 135° plugging angle (135° angle between the plugging direction and the solder pin). This corresponds to a 45° angle between the wire orientation and the circuit board.

- Reflow compatible
- Available in closed (G) and with solder flange (LF).
- Pin length of either 1.5 mm or 3.2 mm

Weidmüller's 3.81 mm pitch (0.15 inch) plug-in connectors are compatible with the layouts of standard connectors and offer space for labelling and coding.

### Product data

IEC: 320 V / 17.5 A  
UL: 300 V / 10 A



For additional articles and information, refer to [catalog.weidmueller.com](http://catalog.weidmueller.com)

#### Note:

- Rated current related to rated cross-section & min. No. of poles.
- Rated data refer only to the component itself. Clearance and creepage distances to other components are to be designed in accordance with the relevant application standards.
- P on drawing = pitch

### SC-SMT 3.81../135G

closed side



#### Dimensioned drawing

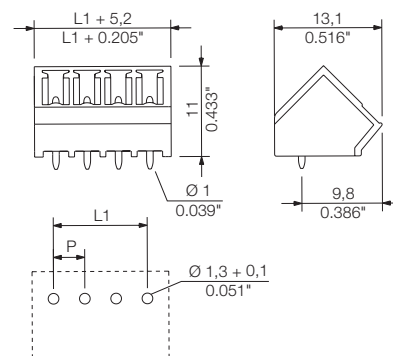

### Technical data

#### In compliance with IEC 60664-1 / IEC 61984

Clamping range, max.			
<b>Solid core H05(07) V-U</b>			
Stranded H07 V-R			
Flexible H05(07) V-K			
Flexible with ferrule			
Ferrule with plastic collar			
Stripping length			
Screwdriver blade	mm		
According to norm			
Tightening torque range			
<b>Rated current, max.</b>	<b>A</b>	<b>17.5</b>	<b>17.5</b>
At ambient temperature		20°C	40°C
For conductor cross-section			
Overvoltage category		III	III II
Pollution severity		3	2 2
<b>Rated voltage</b>	<b>V</b>	<b>160</b>	<b>160 320</b>
Rated impulse voltage	kV	2.5	2.5 2.5
<b>UL / CUL (Use Group)</b>		<b>B</b>	<b>C D</b>
<b>Rated voltage</b>	<b>V</b>	<b>300</b>	<b>300</b>
<b>Rated current</b>	<b>A</b>	<b>10</b>	<b>10</b>
<b>AWG conductor</b>	<b>AWG</b>		-
<b>CSA (Use Group)</b>		<b>B</b>	<b>C D</b>
Rated voltage	V	300	
Rated current	A	11	
AWG conductor	AWG		-
<b>General data</b>			
Type of insulation material		LCP GF	
UL 94 flammability rating		V-0	
Contact base material		Copper alloy	
Material of contact surface		tinned	
Pin dimensions = d	mm	1.0, Octagonal	
Solder eyelet Ø = D	mm	1.3	
Solder eyelet Ø tolerance	mm	+ 0,1	

### Accessories

Note: Refer to the Accessories chapter for additional accessories.

Coding	Order No.
SC-SMT 3.81 KO GY BX	1968900000

### Ordering data

Solder pin length		3.2 mm		
Colour		Black		
Pitch	3.81 mm			
Pol.	L1	(inch)	Qty.	Order No.
2	3.81	0.150	50	1977200000
3	7.62	0.300	50	1977210000
4	11.43	0.450	50	1977220000
5	15.24	0.600	50	1977230000
6	19.05	0.750	50	1977240000
7	22.86	0.900	50	1977250000
8	26.67	1.050	50	1977690000
9	30.48	1.200	50	1977700000
10	34.29	1.350	50	1977710000
11	38.10	1.500	50	1977720000
12	41.91	1.650	50	1977730000
13	45.72	1.800	50	1977740000
14	49.53	1.950	50	1977750000
15	53.34	2.100	50	1977760000
16	57.15	2.250	50	1977770000

### SC-SMT 3.81/././135LF

with solder flange



#### Dimensioned drawing

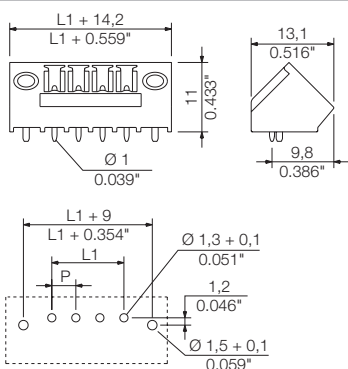

#### Ordering data

Solder pin length		3.2 mm		
Colour		Black		
Pitch		3.81 mm		
Pol.	L1	(inch)	Qty.	Order No.
2	3.81	0.150	50	1978080000
3	7.62	0.300	50	1978090000
4	11.43	0.450	50	1978100000
5	15.24	0.600	50	1978110000
6	19.05	0.750	50	1978120000
7	22.86	0.900	50	1978130000
8	26.67	1.050	50	1978140000
9	30.48	1.200	50	1978150000
10	34.29	1.350	50	1978160000
11	38.10	1.500	50	1978170000
12	41.91	1.650	50	1978180000
13	45.72	1.800	50	1978190000
14	49.53	1.950	50	1978200000
15	53.34	2.100	50	1978210000
16	57.15	2.250	50	1978220000

## Connectors in 3.81 mm pitch Series BC/SC 3.81

### SC-SMT 3.81../270

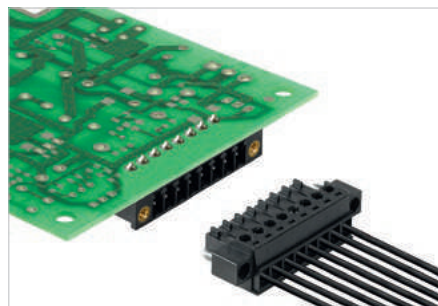

High-temperature-resistant male header with 270° plugging angle (the angle between the plugging direction and the solder pin). This angle has a plugging direction that is parallel to the circuit board with female plugs plugged in upside down.

- Reflow compatible
- Available in closed (G) version and with screw flange (F).
- Pin length of either 1.5 mm or 3.2 mm

Weidmüller's 3.81 mm pitch (0.15 inch) plug-in connectors are compatible with the layouts of standard connectors and offer space for labelling and coding.

### Product data

IEC: 320 V / 17.5 A  
UL: 300 V / 10 A



For additional articles and information, refer to [catalog.weidmueller.com](http://catalog.weidmueller.com)

#### Note:

- Rated current related to rated cross-section & min. No. of poles.
- Rated data refer only to the component itself. Clearance and creepage distances to other components are to be designed in accordance with the relevant application standards.
- P on drawing = pitch

### SC-SMT 3.81../270G

closed side



#### Dimensioned drawing

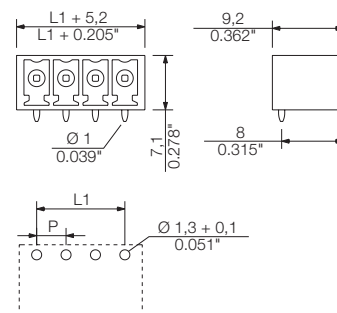

### Technical data

#### In compliance with IEC 60664-1 / IEC 61984

Clamping range, max.			
<b>Solid core H05(07) V-U</b>			
Stranded H07 V-R			
Flexible H05(07) V-K			
Flexible with ferrule			
Ferrule with plastic collar			
Stripping length			
Screwdriver blade	mm		
According to norm			
Tightening torque range			
<b>Rated current, max.</b>	<b>A</b>	<b>17.5</b>	<b>17.5</b>
At ambient temperature		20°C	40°C
For conductor cross-section			
Overvoltage category		III	III II
Pollution severity		3	2 2
<b>Rated voltage</b>	<b>V</b>	<b>160</b>	<b>160 320</b>
Rated impulse voltage	kV	2.5	2.5 2.5
<b>UL / CUL (Use Group)</b>		<b>B</b>	<b>C D</b>
<b>Rated voltage</b>	<b>V</b>	<b>300</b>	<b>300</b>
<b>Rated current</b>	<b>A</b>	<b>10</b>	<b>10</b>
<b>AWG conductor</b>	<b>AWG</b>		-
<b>CSA (Use Group)</b>		<b>B</b>	<b>C D</b>
Rated voltage	V	300	
Rated current	A	8	
AWG conductor	AWG		-
<b>General data</b>			
Type of insulation material		LCP GF	
UL 94 flammability rating		V-0	
Contact base material		Copper alloy	
Material of contact surface		tinned	
Pin dimensions = d	mm	1.0, Octagonal	
Solder eyelet Ø = D	mm	1.3	
Solder eyelet Ø tolerance	mm	+ 0,1	

### Accessories

Note: Refer to the Accessories chapter for additional accessories.

Coding	Order No.
 SC-SMT 3.81 KO GY BX	1968900000

### Ordering data

Solder pin length		3.2 mm		
Colour		Black		
Pitch	3.81 mm			
Pol.	L1	(inch)	Qty.	Order No.
2	3.81	0.150	50	1036480000
3	7.62	0.300	50	1036490000
4	11.43	0.450	50	1036510000
5	15.24	0.600	50	1036520000
6	19.05	0.750	50	1036530000
7	22.86	0.900	50	1036540000
8	26.67	1.050	50	1036550000
9	30.48	1.200	50	1036560000
10	34.29	1.350	50	1036570000
11	38.10	1.500	50	1036580000
12	41.91	1.650	50	1036590000
13	45.72	1.800	50	1036610000
14	49.53	1.950	50	1036620000
15	53.34	2.100	50	1036630000
16	57.15	2.250	50	1036640000

**SC-SMT 3.81/././270F**

with screw flange



Dimensioned drawing

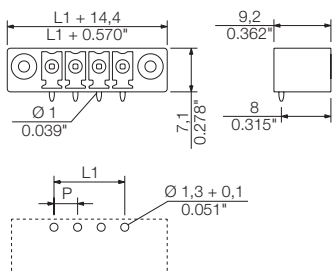

**Ordering data**

Solder pin length		3.2 mm		
Colour		Black		
Pitch		3.81 mm		
Pol.	L1	(inch)	Qty.	Order No.
2	3.81	0.150	50	1036990000
3	7.62	0.300	50	1037010000
4	11.43	0.450	50	1037020000
5	15.24	0.600	50	1037030000
6	19.05	0.750	50	1037040000
7	22.86	0.900	50	1037050000
8	26.67	1.050	50	1037060000
9	30.48	1.200	50	1037070000
10	34.29	1.350	50	1037080000
11	38.10	1.500	50	1037090000
12	41.91	1.650	50	1037110000
13	45.72	1.800	50	1037120000
14	49.53	1.950	50	1037130000
15	53.34	2.100	50	1037140000
16	57.15	2.250	50	1037150000

### SCD-THR 3.81../90

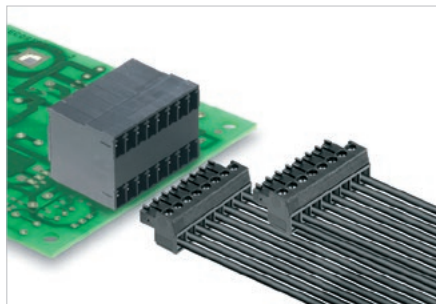

High-temperature-resistant, double-level male header for reflow soldering.

- Orientation: 90°
- Designed for front panel applications.
- Available in closed (G) version and with screw flange (F).

Weidmüller's 3.81 mm pitch (0.15 inch) plug-in connectors are compatible with the layouts of standard connectors and offer space for labelling and coding.

### Product data

IEC: 320 V / 17.5 A  
UL: 300 V / 10 A



For additional articles and information, refer to [catalog.weidmueller.com](http://catalog.weidmueller.com)

#### Note:

- Rated current related to rated cross-section & min. No. of poles.
- Rated data refer only to the component itself. Clearance and creepage distances to other components are to be designed in accordance with the relevant application standards.
- P on drawing = pitch

### SCD-THR 3.81../90G

closed side



#### Dimensioned drawing

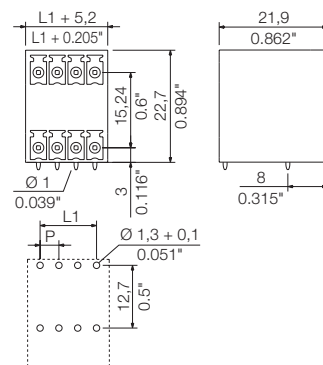

### Ordering data

Solder pin length		3.2 mm		
Colour		Black		
Pitch	3.81 mm			
Pol.	L1	(inch)	Qty.	Order No.
4	3.81	0.150	50	1973730000
6	7.62	0.300	50	1973740000
8	11.43	0.450	50	1973750000
10	15.24	0.600	50	1973760000
12	19.05	0.750	50	1973770000
14	22.86	0.900	50	1973780000
16	26.67	1.050	50	1973790000
18	30.48	1.200	50	1973800000
20	34.29	1.350	50	1973810000
22	38.10	1.500	50	1973820000
24	41.91	1.650	50	1973830000
26	45.72	1.800	20	1973840000
28	49.53	1.950	20	1973850000
30	53.34	2.100	20	1973860000
32	57.15	2.250	20	1973870000

### Technical data

In compliance with IEC 60664-1 / IEC 61984			
Clamping range, max.			
<b>Solid core H05(07) V-U</b>			
Stranded H07 V-R			
Flexible H05(07) V-K			
Flexible with ferrule			
Ferrule with plastic collar			
Stripping length			
Screwdriver blade			
mm			
According to norm			
Tightening torque range			
<b>Rated current, max.</b>			
A 17.5 17			
At ambient temperature			
20°C 40°C			
For conductor cross-section			
Overvoltage category			
III III II			
Pollution severity			
3 2 2			
<b>Rated voltage</b>			
V 160 160 320			
Rated impulse voltage			
kV 2.5 2.5 2.5			
<b>UL / CUL (Use Group)</b>			
B C D			
<b>Rated voltage</b>			
V 300 300			
<b>Rated current</b>			
A 10 10			
<b>AWG conductor</b>			
AWG -			
<b>CSA (Use Group)</b>			
B C D			
Rated voltage			
V 300			
Rated current			
A 11			
AWG conductor			
AWG -			
<b>General data</b>			
Type of insulation material			
LCP GF			
UL 94 flammability rating			
V-0			
Contact base material			
Copper alloy			
Material of contact surface			
tinned			
Pin dimensions = d			
mm 1.0, Octagonal			
Solder eyelet Ø = D			
mm 1.3			
Solder eyelet Ø tolerance			
mm + 0,1			

### Accessories

Note: Refer to the Accessories chapter for additional accessories.

Coding	Order No.
SC-SMT 3.81 KO GY BX	1968900000





SCD-THR 3.81../90F

with screw flange



Dimensioned drawing

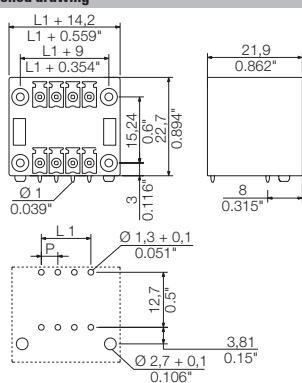

Ordering data

Solder pin length		3.2 mm		
Colour		Black		
Pitch		3.81 mm		
Pol.	L1	(inch)	Qty.	Order No.
4	3.81	0.150	50	1974180000
6	7.62	0.300	50	1974190000
8	11.43	0.450	50	1974200000
10	15.24	0.600	50	1974210000
12	19.05	0.750	50	1974220000
14	22.86	0.900	50	1974230000
16	26.67	1.050	50	1974240000
18	30.48	1.200	50	1974250000
20	34.29	1.350	50	1974290000
22	38.10	1.500	50	1974310000
24	41.91	1.650	50	1974330000
26	45.72	1.800	20	1974350000
28	49.53	1.950	20	1974440000
30	53.34	2.100	20	1974470000
32	57.15	2.250	20	1974490000

## Connectors in 3.81 mm pitch Series BC/SC 3.81

### SCD-THR 3.81/./180

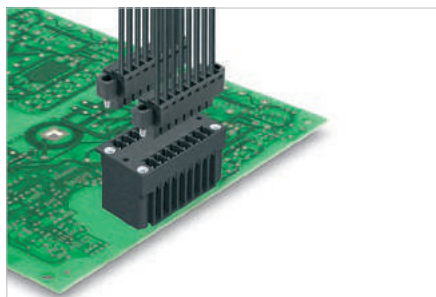

High-temperature-resistant, double-level male header for reflow soldering.

- It allows you to use two interfaces on only one surface and with only one step in the work flow.
- Orientation: 180° (recumbent)
- Connections at the same level and with access that is flush over the front board.
- Space for labelling and coding
- Packed in cardboard box.

Weidmüller's 3.81 mm pitch (0.15 inch) plug-in connectors are compatible with the layouts of standard connectors and offer space for labelling and coding.

### Product data

IEC: 320 V / 17.5 A  
UL: 300 V / 10 A



For additional articles and information, refer to [catalog.weidmueller.com](http://catalog.weidmueller.com)

#### Note:

- Rated current related to rated cross-section & min. No. of poles.
- Rated data refer only to the component itself. Clearance and creepage distances to other components are to be designed in accordance with the relevant application standards.
- P on drawing = pitch

### SCD-THR 3.81/./180G

closed side



#### Dimensioned drawing

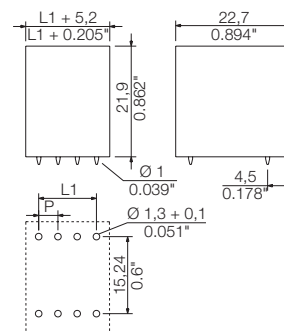

F

### Technical data

In compliance with IEC 60664-1 / IEC 61984			
Clamping range, max.			
<b>Solid core H05(07) V-U</b>			
Stranded H07 V-R			
Flexible H05(07) V-K			
Flexible with ferrule			
Ferrule with plastic collar			
Stripping length			
Screwdriver blade	mm		
According to norm			
Tightening torque range			
<b>Rated current, max.</b>	<b>A</b>	<b>17.5</b>	<b>17</b>
At ambient temperature		20°C	40°C
For conductor cross-section			
Overvoltage category		III	III II
Pollution severity		3	2 2
<b>Rated voltage</b>	<b>V</b>	<b>160</b>	<b>160 320</b>
Rated impulse voltage	kV	2.5	2.5 2.5
<b>UL / CUL (Use Group)</b>		<b>B</b>	<b>C D</b>
<b>Rated voltage</b>	<b>V</b>	<b>300</b>	<b>300</b>
<b>Rated current</b>	<b>A</b>	<b>10</b>	<b>10</b>
<b>AWG conductor</b>	<b>AWG</b>		-
<b>CSA (Use Group)</b>		<b>B</b>	<b>C D</b>
Rated voltage	V	300	
Rated current	A	11	
AWG conductor	AWG		-
<b>General data</b>			
Type of insulation material		LCP GF	
UL 94 flammability rating		V-0	
Contact base material		Copper alloy	
Material of contact surface		tinned	
Pin dimensions = d	mm	1.0, Octagonal	
Solder eyelet Ø = D	mm	1.3	
Solder eyelet Ø tolerance	mm	+ 0,1	

### Accessories

Note: Refer to the Accessories chapter for additional accessories.

Coding	Order No.
SC-SMT 3.81 KO GY BX	<b>1968900000</b>
<b>Mounting screw</b>	
PTSC KA 2.2X4.5 WN1412	<b>1610740000</b>

### Ordering data

Solder pin length		3.2 mm		
Colour		Black		
Pitch	3.81 mm			
Pol.	L1	(inch)	Qty.	Order No.
4	3.81	0.150	50	<b>1030950000</b>
6	7.62	0.300	50	<b>1030960000</b>
8	11.43	0.450	50	<b>1030970000</b>
10	15.24	0.600	50	<b>1030980000</b>
12	19.05	0.750	50	<b>1030990000</b>
14	22.86	0.900	50	<b>1031010000</b>
16	26.67	1.050	50	<b>1031020000</b>
18	30.48	1.200	50	<b>1031030000</b>
20	34.29	1.350	50	<b>1031040000</b>
22	38.10	1.500	50	<b>1031050000</b>
24	41.91	1.650	50	<b>1031060000</b>
26	45.72	1.800	20	<b>1031070000</b>
28	49.53	1.950	20	<b>1031080000</b>
30	53.34	2.100	20	<b>1031090000</b>
32	57.15	2.250	20	<b>1031110000</b>

### SCD-THR 3.81.././180F

with screw flange



Dimensioned drawing

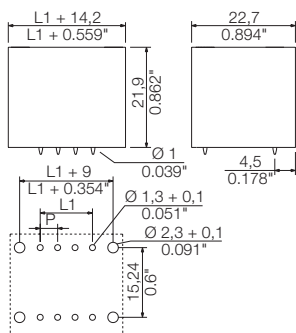

### Ordering data

Solder pin length		3.2 mm		
Colour		Black		
Pitch		3.81 mm		
Pol.	L1	(inch)	Qty.	Order No.
4	3.81	0.150	50	1031460000
6	7.62	0.300	50	1031470000
8	11.43	0.450	50	1031490000
10	15.24	0.600	50	1031510000
12	19.05	0.750	50	1031520000
14	22.86	0.900	50	1031530000
16	26.67	1.050	50	1031540000
18	30.48	1.200	50	1031560000
20	34.29	1.350	50	1031570000
22	38.10	1.500	50	1031590000
24	41.91	1.650	50	1031610000
26	45.72	1.800	20	1031620000
28	49.53	1.950	20	1031630000
30	53.34	2.100	20	1031640000
32	57.15	2.250	20	1031660000

## Connectors in 3.81 mm pitch Series BC/SC 3.81

### SCDN-THR 3.81/./90

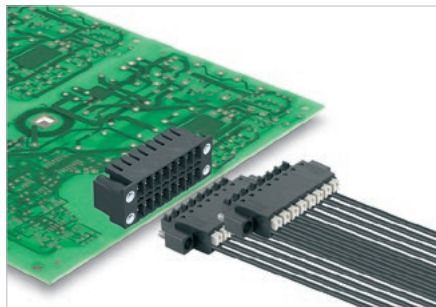

Compact double-level male header for reflow soldering process. For use with BCF 3.81 plugs.

- Orientation: 90°
- Designed for front panel applications.
- Available in closed (G) version and with screw flange (F).

Weidmüller's 3.81 mm pitch (0.15 inch) plug-in connectors are compatible with the layouts of standard connectors and offer space for labelling and coding.

### Product data

IEC: 320 V / 17.5 A  
UL: 300 V / 10 A



For additional articles and information, refer to [catalog.weidmueller.com](http://catalog.weidmueller.com)

#### Note:

- Rated current related to rated cross-section & min. No. of poles.
- Rated data refer only to the component itself. Clearance and creepage distances to other components are to be designed in accordance with the relevant application standards.
- P on drawing = pitch

### SCDN-THR 3.81/./90G

closed side



#### Dimensioned drawing

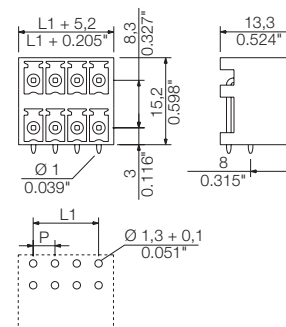

### Technical data

#### In compliance with IEC 60664-1 / IEC 61984

Clamping range, max.			
<b>Solid core H05(07) V-U</b>			
Stranded H07 V-R			
Flexible H05(07) V-K			
Flexible with ferrule			
Ferrule with plastic collar			
Stripping length			
Screwdriver blade	mm		
According to norm			
Tightening torque range			
<b>Rated current, max.</b>	<b>A</b>	<b>17.5</b>	<b>17</b>
At ambient temperature		20°C	40°C
For conductor cross-section			
Overvoltage category		III	III II
Pollution severity		3	2 2
<b>Rated voltage</b>	<b>V</b>	<b>160</b>	<b>160 320</b>
Rated impulse voltage	kV	2.5	2.5 2.5
<b>UL / CUL (Use Group)</b>		<b>B</b>	<b>C D</b>
<b>Rated voltage</b>	<b>V</b>	<b>300</b>	<b>300</b>
<b>Rated current</b>	<b>A</b>	<b>10</b>	<b>10</b>
<b>AWG conductor</b>	<b>AWG</b>		-
<b>CSA (Use Group)</b>		<b>B</b>	<b>C D</b>
Rated voltage	V	300	300
Rated current	A	11	11
AWG conductor	AWG		-
<b>General data</b>			
Type of insulation material		LCP GF	
UL 94 flammability rating		V-0	
Contact base material		Copper alloy	
Material of contact surface		tinned	
Pin dimensions = d	mm	1.0, Octagonal	
Solder eyelet Ø = D	mm	1.3	
Solder eyelet Ø tolerance	mm	+ 0,1	

### Accessories

Note: Refer to the Accessories chapter for additional accessories.

Coding	Order No.
SC-SMT 3.81 KO GY BX	1968900000

### Ordering data

Solder pin length		3.2 mm		
Colour		Black		
Pitch	3.81 mm			
Pol.	L1	(inch)	Qty.	Order No.
4	3.81	0.150	50	1038950000
6	7.62	0.300	50	1038960000
8	11.43	0.450	50	1038970000
10	15.24	0.600	50	1038980000
12	19.05	0.750	50	1038990000
14	22.86	0.900	50	1039010000
16	26.67	1.050	50	1039020000
18	30.48	1.200	50	1039030000
20	34.29	1.350	50	1039040000
22	38.10	1.500	50	1039050000
24	41.91	1.650	50	1039060000
26	45.72	1.800	20	1039070000
28	49.53	1.950	20	1039080000
30	53.34	2.100	20	1039090000
32	57.15	2.250	20	1039100000

3.81

90°

**SCDN-THR 3.81/././90F**

with screw flange



Dimensioned drawing

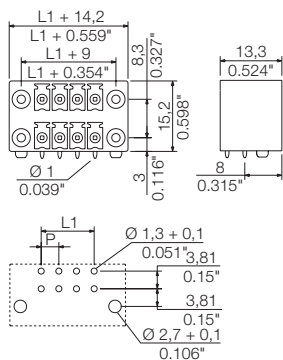

**Ordering data**

Solder pin length		3.2 mm		
Colour		Black		
<b>Pitch</b>		<b>3.81 mm</b>		
Pol.	L1	(inch)	Qty.	Order No.
4	3.81	0.150	50	1039440000
6	7.62	0.300	50	1039450000
8	11.43	0.450	50	1039460000
10	15.24	0.600	50	1039520000
12	19.05	0.750	50	1039530000
14	22.86	0.900	50	1039540000
16	26.67	1.050	50	1039550000
18	30.48	1.200	50	1039560000
20	34.29	1.350	50	1039570000
22	38.10	1.500	50	1039580000
24	41.91	1.650	50	1039590000
26	45.72	1.800	20	1039610000
28	49.53	1.950	20	1039720000
30	53.34	2.100	20	1039730000
32	57.15	2.250	20	1039740000



## Connectors in 3.81 mm pitch Series BC/SC 3.81

### SCDV-THR 3.81/..../90

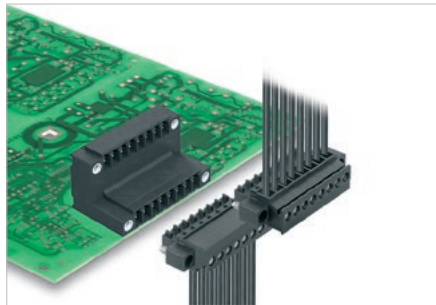

High-temperature-resistant, double-level male header for reflow soldering.

- Orientation: 90°
- Connections at two offset levels and open access to each row.
- Available in closed (G) version and with screw flange (F).

Weidmüller's 3.81 mm pitch (0.15 inch) plug-in connectors are compatible with the layouts of standard connectors and offer space for labelling and coding.

### Product data

IEC: 320 V / 17.5 A  
UL: 300 V / 10 A



For additional articles and information, refer to [catalog.weidmueller.com](http://catalog.weidmueller.com)

#### Note:

- Rated current related to rated cross-section & min. No. of poles.
- Rated data refer only to the component itself. Clearance and creepage distances to other components are to be designed in accordance with the relevant application standards.
- P on drawing = pitch

### SCDV-THR 3.81/..../90G

closed side



#### Dimensioned drawing

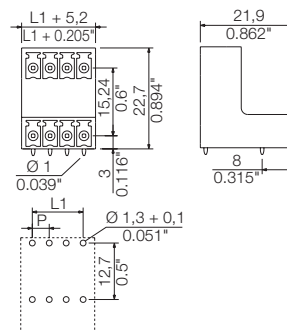

F

### Technical data

#### In compliance with IEC 60664-1 / IEC 61984

Clamping range, max.			
<b>Solid core H05(07) V-U</b>			
Stranded H07 V-R			
Flexible H05(07) V-K			
Flexible with ferrule			
Ferrule with plastic collar			
Stripping length			
Screwdriver blade	mm		
According to norm			
Tightening torque range			
<b>Rated current, max.</b>	<b>17.5</b>	<b>17</b>	
At ambient temperature	20°C	40°C	
For conductor cross-section			
Overvoltage category	III	III	II
Pollution severity	3	2	2
<b>Rated voltage</b>	<b>V</b>	<b>160</b>	<b>160 320</b>
Rated impulse voltage	kV	2.5	2.5 2.5
<b>UL / CUL (Use Group)</b>		<b>B</b>	<b>C D</b>
<b>Rated voltage</b>	<b>V</b>	<b>300</b>	<b>300</b>
<b>Rated current</b>	<b>A</b>	<b>10</b>	<b>10</b>
<b>AWG conductor</b>	<b>AWG</b>	-	-
<b>CSA (Use Group)</b>		<b>B</b>	<b>C D</b>
Rated voltage	V	300	300
Rated current	A	11	11
AWG conductor	AWG	-	-
<b>General data</b>			
Type of insulation material	LCP GF		
UL 94 flammability rating	V-0		
Contact base material	Copper alloy		
Material of contact surface	tinned		
Pin dimensions = d	mm	1.0, Octagonal	
Solder eyelet Ø = D	mm	1.3	
Solder eyelet Ø tolerance	mm	+ 0,1	

### Accessories

Note: Refer to the Accessories chapter for additional accessories.

Coding	Order No.
SC-SMT 3.81 KO GY BX	1968900000

### Ordering data

Solder pin length		3.2 mm		
Colour		Black		
Pitch	3.81 mm			
Pol.	L1	(inch)	Qty.	Order No.
4	3.81	0.150	50	1033490000
6	7.62	0.300	50	1033510000
8	11.43	0.450	50	1033520000
10	15.24	0.600	50	1033530000
12	19.05	0.750	50	1033540000
14	22.86	0.900	50	1033550000
16	26.67	1.050	50	1033560000
18	30.48	1.200	50	1033570000
20	34.29	1.350	50	1033580000
22	38.10	1.500	50	1033590000
24	41.91	1.650	50	1033600000
28	49.53	1.950	20	1033620000
30	53.34	2.100	20	1033630000
32	57.15	2.250	20	1033640000

## SCDV-THR 3.81/././90F

with screw flange



Dimensioned drawing

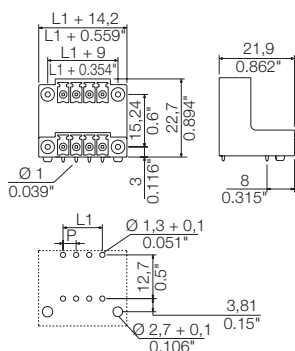

### Ordering data

Solder pin length		3.2 mm		
Colour		Black		
Pitch		3.81 mm		
Pol.	L1	(inch)	Qty.	Order No.
4	3.81	0.150	50	1033970000
6	7.62	0.300	50	1033980000
8	11.43	0.450	50	1033990000
10	15.24	0.600	50	1034010000
12	19.05	0.750	50	1034020000
14	22.86	0.900	50	1034030000
16	26.67	1.050	50	1034040000
18	30.48	1.200	50	1034050000
20	34.29	1.350	50	1034060000
22	38.10	1.500	50	1034070000
24	41.91	1.650	50	1034080000
26	45.72	1.800	20	1034090000
28	49.53	1.950	20	1034110000
30	53.34	2.100	20	1034120000
32	57.15	2.250	20	1034130000

## Connectors in 3.81 mm pitch Series BC/SC 3.81

### SCDV-THR 3.81/./180

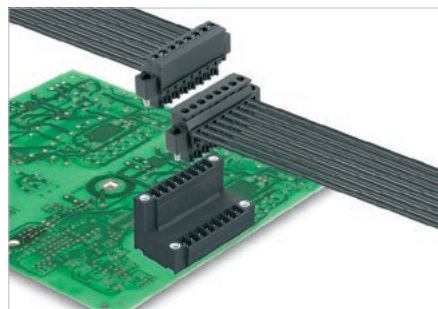

High-temperature-resistant, double-level male header for reflow soldering.

- Orientation: 180°
- Connections at two offset levels and open access to each row.
- Available in closed (G) version and with screw flange (F).

Weidmüller's 3.81 mm pitch (0.15 inch) plug-in connectors are compatible with the layouts of standard connectors and offer space for labelling and coding.

### Product data

IEC: 320 V / 17.5 A  
UL: 300 V / 10 A



For additional articles and information, refer to [catalog.weidmueller.com](http://catalog.weidmueller.com)

#### Note:

- Rated current related to rated cross-section & min. No. of poles.
- Rated data refer only to the component itself. Clearance and creepage distances to other components are to be designed in accordance with the relevant application standards.
- P on drawing = pitch

### SCDV-THR 3.81/./180G

closed side



#### Dimensioned drawing

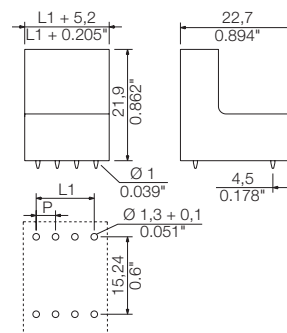



### Technical data

#### In compliance with IEC 60664-1 / IEC 61984

Clamping range, max.			
<b>Solid core H05(07) V-U</b>			
Stranded H07 V-R			
Flexible H05(07) V-K			
Flexible with ferrule			
Ferrule with plastic collar			
Stripping length			
Screwdriver blade	mm		
According to norm			
Tightening torque range			
<b>Rated current, max.</b>	<b>A</b>	<b>17.5</b>	<b>17</b>
At ambient temperature		20°C	40°C
For conductor cross-section			
Overvoltage category		III	III II
Pollution severity		3	2 2
<b>Rated voltage</b>	<b>V</b>	<b>160</b>	<b>160 320</b>
Rated impulse voltage	kV	2.5	2.5 2.5
<b>UL / CUL (Use Group)</b>		<b>B</b>	<b>C D</b>
<b>Rated voltage</b>	<b>V</b>	<b>300</b>	<b>300</b>
<b>Rated current</b>	<b>A</b>	<b>10</b>	<b>10</b>
<b>AWG conductor</b>	<b>AWG</b>		-
<b>CSA (Use Group)</b>		<b>B</b>	<b>C D</b>
Rated voltage	V	300	300
Rated current	A	11	11
AWG conductor	AWG		-
<b>General data</b>			
Type of insulation material		LCP GF	
UL 94 flammability rating		V-0	
Contact base material		Copper alloy	
Material of contact surface		tinned	
Pin dimensions = d	mm	1.0, Octagonal	
Solder eyelet Ø = D	mm	1.3	
Solder eyelet Ø tolerance	mm	+ 0,1	

### Accessories

Note: Refer to the Accessories chapter for additional accessories.

Coding		Order No.
	SC-SMT 3.81 KO GY BX	1968900000
<b>Mounting screw</b>		
	PTSC KA 2.2X4.5 WN1412	1610740000

### Ordering data

Solder pin length		3.2 mm		
Colour		Black		
Pitch	3.81 mm			
Pol.	L1	(inch)	Qty.	Order No.
4	3.81	0.150	50	1035470000
6	7.62	0.300	50	1035480000
8	11.43	0.450	50	1035490000
10	15.24	0.600	50	1035510000
12	19.05	0.750	50	1035520000
14	22.86	0.900	50	1035530000
16	26.67	1.050	50	1035540000
18	30.48	1.200	50	1035550000
20	34.29	1.350	50	1035560000
22	38.10	1.500	50	1035570000
24	41.91	1.650	50	1035580000
26	45.72	1.800	20	1035590000
28	49.53	1.950	20	1035610000
30	53.34	2.100	20	1035620000
32	57.15	2.250	20	1035630000



## SCDV-THR 3.81/././180F

with screw flange



Dimensioned drawing

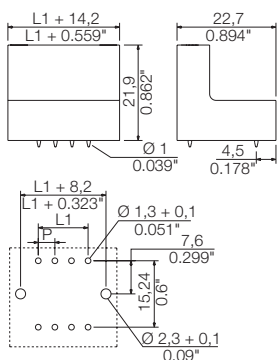

### Ordering data

Solder pin length		3.2 mm		
Colour		Black		
Pitch		3.81 mm		
Pol.	L1	(inch)	Qty.	Order No.
4	3.81	0.150	50	1035950000
6	7.62	0.300	50	1035960000
8	11.43	0.450	50	1035970000
10	15.24	0.600	50	1035980000
12	19.05	0.750	50	1035990000
14	22.86	0.900	50	1036010000
16	26.67	1.050	50	1036020000
18	30.48	1.200	50	1036030000
20	34.29	1.350	50	1036040000
22	38.10	1.500	50	1036050000
24	41.91	1.650	50	1036060000
26	45.72	1.800	20	1036070000
28	49.53	1.950	20	1036080000
30	53.34	2.100	20	1036090000
32	57.15	2.250	20	1036110000

## Connectors in 3.81 mm pitch Series BC/SC 3.81

### SC 3.81/./90

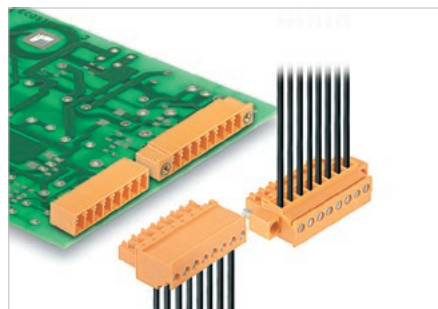

Male header with plugging direction in parallel to the circuit board.  
 • Available in closed (G) version and with screw flange (F)

Weidmüller's 3.81 mm pitch (0.15 inch) plug-in connectors are compatible with the layouts of standard connectors. They support a flood-light display and offer space for labelling and coding.

### Product data

IEC: 320 V / 17.5 A  
 UL: 300 V / 10 A



For additional articles and information, refer to [catalog.weidmueller.com](http://catalog.weidmueller.com)

#### Note:

- Additional colours on request
- Rated current related to rated cross-section & min. No. of poles.
- Rated data refer only to the component itself. Clearance and creepage distances to other components are to be designed in accordance with the relevant application standards.
- P on drawing = pitch

### SC 3.81/./90G

closed side

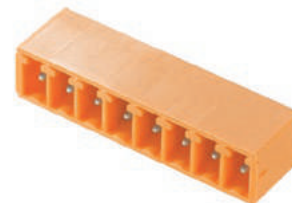

#### Dimensioned drawing

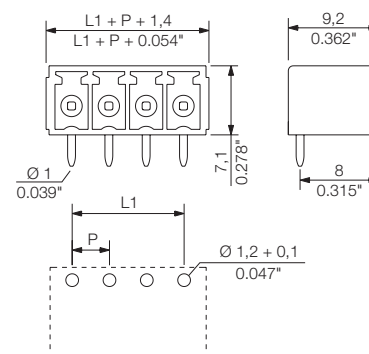

### Technical data

#### In compliance with IEC 60664-1 / IEC 61984

Clamping range, max.			
<b>Solid core H05(07) V-U</b>			
Stranded H07 V-R			
Flexible H05(07) V-K			
Flexible with ferrule			
Ferrule with plastic collar			
Stripping length			
Screwdriver blade	mm		
According to norm			
Tightening torque range			
<b>Rated current, max.</b>	<b>A</b>	<b>17.5</b>	<b>17.5</b>
At ambient temperature		20°C	40°C
For conductor cross-section			
Overvoltage category		III	III II
Pollution severity		3	2 2
<b>Rated voltage</b>	<b>V</b>	<b>160</b>	<b>160 320</b>
Rated impulse voltage	kV	2.5	2.5 2.5
<b>UL / CUL (Use Group)</b>		<b>B</b>	<b>C D</b>
<b>Rated voltage</b>	<b>V</b>	<b>300</b>	<b>300</b>
<b>Rated current</b>	<b>A</b>	<b>10</b>	<b>10</b>
<b>AWG conductor</b>	<b>AWG</b>		-
<b>CSA (Use Group)</b>		<b>B</b>	<b>C D</b>
Rated voltage	V	300	
Rated current	A	8	
AWG conductor	AWG		-
<b>General data</b>			
Type of insulation material		PA GF	
UL 94 flammability rating		V-0	
Contact base material		Copper alloy	
Material of contact surface		tinned	
Pin dimensions = d	mm	1.0, Octagonal	
Solder eyelet Ø = D	mm	1.2	
Solder eyelet Ø tolerance	mm	+ 0,1	

### Accessories

Note: Refer to the Accessories chapter for additional accessories.

Coding		Order No.
	SC-SMT 3.81 KO GY BX	1968900000
<b>LED light guide</b>		
	SC 3.81 FLA 1.5/14.25	1979730000
	SC 3.81 FLA 2.3/14.25	1979750000
	SC 3.81 FLA 1.5/16	1979720000
	SC 3.81 FLA 2.3/16	1979740000

### Ordering data

Solder pin length		3.2 mm		
Colour		Orange		
Pitch	3.81 mm			
Pol.	L1	(inch)	Qty.	Order No.
2	3.81	0.150	50	1942020000
3	7.62	0.300	50	1942040000
4	11.43	0.450	50	1942070000
5	15.24	0.600	50	1942090000
6	19.05	0.750	50	1942100000
7	22.86	0.900	50	1942120000
8	26.67	1.050	50	1942130000
9	30.48	1.200	50	1942140000
10	34.29	1.350	50	1942150000
11	38.10	1.500	50	1942160000
12	41.91	1.650	50	1942170000
13	45.72	1.800	50	1942180000
14	49.53	1.950	50	1942190000
15	53.34	2.100	50	1942200000
16	57.15	2.250	50	1942210000
17	60.96	2.400	50	1942220000
18	64.77	2.550	50	1942230000
19	68.58	2.700	50	1942240000
20	72.39	2.850	50	1942250000

3.81

90°

### SC 3.81/..90F

with screw flange



Dimensioned drawing

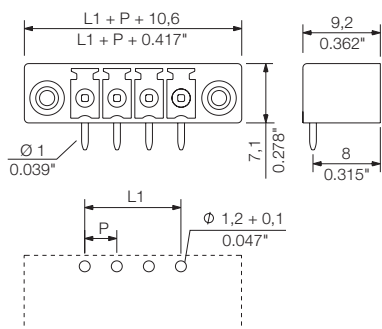

### Ordering data

Solder pin length		3.2 mm		
Colour		Orange		
Pitch		3.81 mm		
Pol.	L1	(inch)	Qty.	Order No.
2	3.81	0.150	50	1942450000
3	7.62	0.300	50	1942460000
4	11.43	0.450	50	1942470000
5	15.24	0.600	50	1942480000
6	19.05	0.750	50	1942490000
7	22.86	0.900	50	1942500000
8	26.67	1.050	50	1942510000
9	30.48	1.200	50	1942520000
10	34.29	1.350	50	1942530000
11	38.10	1.500	50	1942540000
12	41.91	1.650	50	1942550000
13	45.72	1.800	50	1942560000
14	49.53	1.950	50	1942570000
15	53.34	2.100	50	1942580000
16	57.15	2.250	50	1942590000
17	60.96	2.400	50	1942600000
18	64.77	2.550	50	1942610000
19	68.58	2.700	50	1942620000
20	72.39	2.850	50	1942630000

SC 3.81/./180

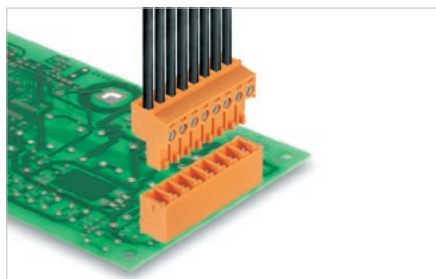

The 180° male header has a perpendicular plugging direction in relation to the circuit board. It is available in closed (G) and screw flange (F) versions.

Weidmüller's 3.81 mm pitch (0.15 inch) plug-in connectors are compatible with the layouts of standard connectors and offer space for labelling and coding.

Product data

IEC: 320 V / 17.5 A  
UL: 300 V / 10 A



For additional articles and information, refer to [catalog.weidmueller.com](http://catalog.weidmueller.com)

Note:

- Additional colours on request
- Rated current related to rated cross-section & min. No. of poles.
- Rated data refer only to the component itself. Clearance and creepage distances to other components are to be designed in accordance with the relevant application standards.
- P on drawing = pitch

SC 3.81/./180G

closed side



Dimensioned drawing

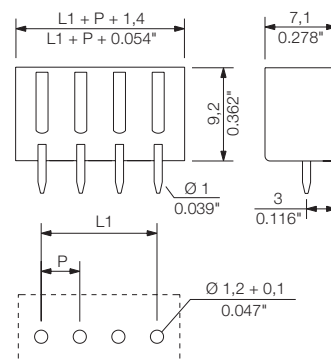

Technical data

In compliance with IEC 60664-1 / IEC 61984

Clamping range, max.			
<b>Solid core H05(07) V-U</b>			
Stranded H07 V-R			
Flexible H05(07) V-K			
Flexible with ferrule			
Ferrule with plastic collar			
Stripping length			
Screwdriver blade	mm		
According to norm			
Tightening torque range			
<b>Rated current, max.</b>	<b>A</b>	<b>17.5</b>	<b>17.5</b>
At ambient temperature		20°C	40°C
For conductor cross-section			
Overtoltage category		III	III II
Pollution severity		3	2 2
<b>Rated voltage</b>	<b>V</b>	<b>160</b>	<b>160 320</b>
Rated impulse voltage	kV	2.5	2.5 2.5
<b>UL / CUL (Use Group)</b>	<b>B C D</b>		
<b>Rated voltage</b>	<b>V</b>	<b>300</b>	<b>300</b>
<b>Rated current</b>	<b>A</b>	<b>10</b>	<b>10</b>
<b>AWG conductor</b>	<b>AWG</b>		-
<b>CSA (Use Group)</b>	<b>B C D</b>		
Rated voltage	V	300	
Rated current	A	8	
AWG conductor	AWG		-
<b>General data</b>			
Type of insulation material		PA GF	
UL 94 flammability rating		V-0	
Contact base material		Copper alloy	
Material of contact surface		tinned	
Pin dimensions = d	mm	1.0, Octagonal	
Solder eyelet Ø = D	mm	1.2	
Solder eyelet Ø tolerance	mm	+ 0,1	

Accessories

Note: Refer to the Accessories chapter for additional accessories.

Coding	Order No.
SC-SMT 3.81 KO GY BX	1968900000
<b>Mounting screw</b>	
PTSC KA 2.2X4.5 WN1412	1610740000

Ordering data

Solder pin length		3.2 mm		
Colour		Orange		
Pitch	3.81 mm			
Pol.	L1	(inch)	Qty.	Order No.
2	3.81	0.150	50	1942840000
3	7.62	0.300	50	1942850000
4	11.43	0.450	50	1942860000
5	15.24	0.600	50	1942870000
6	19.05	0.750	50	1942880000
7	22.86	0.900	50	1942890000
8	26.67	1.050	50	1942900000
9	30.48	1.200	50	1942910000
10	34.29	1.350	50	1942920000
11	38.10	1.500	50	1942930000
12	41.91	1.650	50	1942940000
13	45.72	1.800	50	1942950000
14	49.53	1.950	50	1942960000
15	53.34	2.100	50	1942970000
16	57.15	2.250	50	1942980000
17	60.96	2.400	50	1942990000
18	64.77	2.550	50	1943000000
19	68.58	2.700	50	1943010000
20	72.39	2.850	50	1943020000

SC 3.81/./180F

with screw flange



Dimensioned drawing

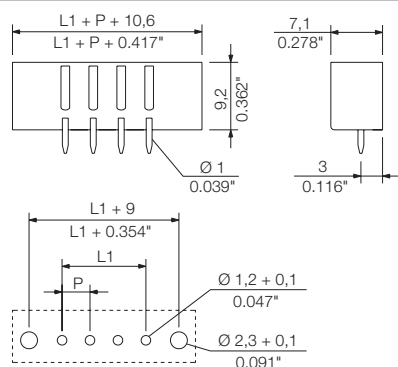

Ordering data

Solder pin length		3.2 mm		
Colour		Orange		
Pitch		3.81 mm		
Pol.	L1	(inch)	Qty.	Order No.
2	3.81	0.150	50	1943180000
3	7.62	0.300	50	1943190000
4	11.43	0.450	50	1943200000
5	15.24	0.600	50	1943210000
6	19.05	0.750	50	1943220000
7	22.86	0.900	50	1943230000
8	26.67	1.050	50	1943240000
9	30.48	1.200	50	1943250000
10	34.29	1.350	50	1943260000
11	38.10	1.500	50	1943270000
12	41.91	1.650	50	1943280000
13	45.72	1.800	50	1943290000
14	49.53	1.950	50	1943300000
15	53.34	2.100	50	1943310000
16	57.15	2.250	50	1943320000
17	60.96	2.400	50	1943330000
18	64.77	2.550	50	1943340000
19	68.58	2.700	50	1943350000
20	72.39	2.850	50	1943360000

## Connectors in 3.81 mm pitch Series BC/SC 3.81

### SC 3.81../135

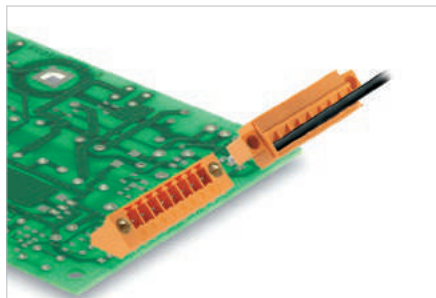

Male header with 135° plugging angle – (135° angle between the plugging direction and the solder pin). This corresponds to a 45° angle between the wire outlet and the circuit board.

- Available in Closed (G) version and with screw flange (F).

Weidmüller's 3.81 mm pitch (0.15 inch) plug-in connectors are compatible with the layouts of standard connectors and offer space for labelling and coding.

**F**

### Technical data

#### In compliance with IEC 60664-1 / IEC 61984

Clamping range, max.			
<b>Solid core H05(07) V-U</b>			
Stranded H07 V-R			
Flexible H05(07) V-K			
Flexible with ferrule			
Ferrule with plastic collar			
Stripping length			
Screwdriver blade	mm		
According to norm			
Tightening torque range			
<b>Rated current, max.</b>	<b>A</b>	<b>17.5</b>	<b>17.5</b>
At ambient temperature		20°C	40°C
For conductor cross-section			
Overvoltage category		III	III II
Pollution severity		3	2 2
<b>Rated voltage</b>	<b>V</b>	<b>160</b>	<b>160 320</b>
Rated impulse voltage	kV	2.5	2.5 2.5
<b>UL / CUL (Use Group)</b>	<b>B C D</b>		
<b>Rated voltage</b>	<b>V</b>	<b>300</b>	<b>300</b>
<b>Rated current</b>	<b>A</b>	<b>10</b>	<b>10</b>
<b>AWG conductor</b>	<b>AWG</b>	-	
<b>CSA (Use Group)</b>	<b>B C D</b>		
Rated voltage	V	300	
Rated current	A	11	
AWG conductor	AWG	-	
<b>General data</b>			
Type of insulation material	PA GF		
UL 94 flammability rating	V-0		
Contact base material	Copper alloy		
Material of contact surface	tinned		
Pin dimensions = d	mm	1.0, Octagonal	
Solder eyelet Ø = D	mm	1.2	
Solder eyelet Ø tolerance	mm	+ 0,1	

### Product data

IEC: 320 V / 17.5 A  
UL: 300 V / 10 A



For additional articles and information, refer to [catalog.weidmueller.com](http://catalog.weidmueller.com)

#### Note:

- Additional colours on request
- Rated current related to rated cross-section & min. No. of poles.
- Rated data refer only to the component itself. Clearance and creepage distances to other components are to be designed in accordance with the relevant application standards.
- P on drawing = pitch

### SC 3.81../135G

closed side



#### Dimensioned drawing

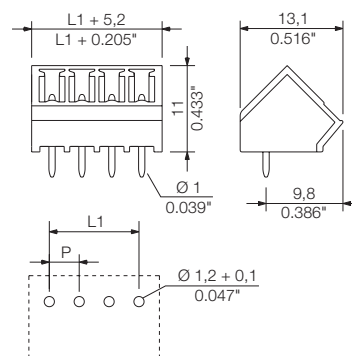

### Accessories

Note: Refer to the Accessories chapter for additional accessories.

Coding	Order No.
SC-SMT 3.81 KO GY BX	1968900000

### Ordering data

Solder pin length		3.2 mm		
Colour		Orange		
Pitch		3.81 mm		
Pol.	L1	(inch)	Qty.	Order No.
2	3.81	0.150	50	1975720000
3	7.62	0.300	50	1975770000
4	11.43	0.450	50	1975800000
5	15.24	0.600	50	1975810000
6	19.05	0.750	50	1975880000
7	22.86	0.900	50	1975900000
8	26.67	1.050	50	1975920000
9	30.48	1.200	50	1975930000
10	34.29	1.350	50	1975940000
11	38.10	1.500	50	1975950000
12	41.91	1.650	50	1975960000
13	45.72	1.800	50	1975970000
14	49.53	1.950	50	1975980000
15	53.34	2.100	50	1975990000
16	57.15	2.250	50	1976000000

### SC 3.81/././135F

with screw flange



Dimensioned drawing

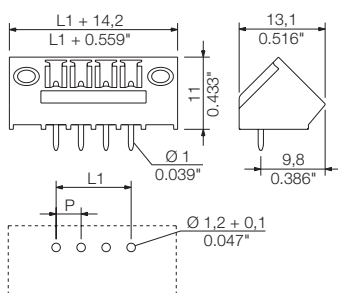

### Ordering data

Solder pin length		3.2 mm	
Colour		Orange	
Pitch		3.81 mm	
Pol.	L1	(inch)	Qty. Order No.
2	3.81	0.150	50 1976740000
3	7.62	0.300	50 1976750000
4	11.43	0.450	50 1976760000
5	15.24	0.600	50 1976770000
6	19.05	0.750	50 1976780000
7	22.86	0.900	50 1976790000
8	26.67	1.050	50 1976800000
9	30.48	1.200	50 1976810000
10	34.29	1.350	50 1976820000
11	38.10	1.500	50 1976830000
12	41.91	1.650	50 1976840000
13	45.72	1.800	50 1976850000
14	49.53	1.950	50 1976860000
15	53.34	2.100	50 1976870000
16	57.15	2.250	50 1976880000

SC 3.81/././270

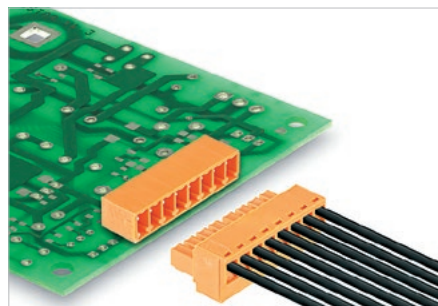

Male header with 270° plugging angle (270° angle between the plugging direction and the solder pin). This angle has a plugging direction that is parallel to the circuit board with female plugs plugged in upside down.

- Available in closed (G) version and with screw flange (F).

Weidmüller's 3.81 mm pitch (0.15 inch) plug-in connectors are compatible with the layouts of standard connectors and offer space for labelling and coding.

Product data

IEC: 320 V / 17.5 A  
UL: 300 V / 10 A



For additional articles and information, refer to [catalog.weidmuller.com](http://catalog.weidmuller.com)

Note:

- Additional colours on request
- Rated current related to rated cross-section & min. No. of poles.
- Rated data refer only to the component itself. Clearance and creepage distances to other components are to be designed in accordance with the relevant application standards.
- P on drawing = pitch

SC 3.81/././270G

closed side



Dimensioned drawing

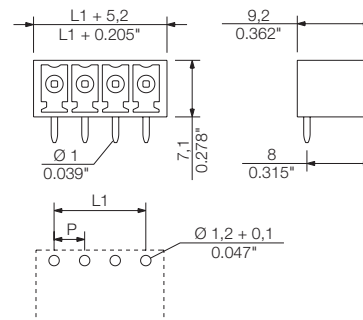

Technical data

In compliance with IEC 60664-1 / IEC 61984

Clamping range, max.			
<b>Solid core H05(07) V-U</b>			
Stranded H07 V-R			
Flexible H05(07) V-K			
Flexible with ferrule			
Ferrule with plastic collar			
Stripping length			
Screwdriver blade	mm		
According to norm			
Tightening torque range			
<b>Rated current, max.</b>	<b>A</b>	<b>17.5</b>	<b>17.5</b>
At ambient temperature		20°C	40°C
For conductor cross-section			
Overtoltage category		III	III II
Pollution severity		3	2 2
<b>Rated voltage</b>	<b>V</b>	<b>160</b>	<b>160 320</b>
Rated impulse voltage	kV	2.5	2.5 2.5
<b>UL / CUL (Use Group)</b>		<b>B</b>	<b>C D</b>
<b>Rated voltage</b>	<b>V</b>	<b>300</b>	<b>300</b>
<b>Rated current</b>	<b>A</b>	<b>10</b>	<b>10</b>
<b>AWG conductor</b>	<b>AWG</b>		-
<b>CSA (Use Group)</b>		<b>B</b>	<b>C D</b>
Rated voltage	V	300	
Rated current	A	8	
AWG conductor	AWG		-
<b>General data</b>			
Type of insulation material		PA GF	
UL 94 flammability rating		V-0	
Contact base material		Copper alloy	
Material of contact surface		tinned	
Pin dimensions = d	mm	1.0, Octagonal	
Solder eyelet Ø = D	mm	1.2	
Solder eyelet Ø tolerance	mm	+ 0,1	

Accessories

Note: Refer to the Accessories chapter for additional accessories.

Coding	Order No.
SC-SMT 3.81 KO GY BX	1968900000

Ordering data

Solder pin length		3.2 mm		
Colour		Orange		
Pitch	3.81 mm			
Pol.	L1	(inch)	Qty.	Order No.
2	3.81	0.150	50	1037490000
3	7.62	0.300	50	1037510000
4	11.43	0.450	50	1037520000
5	15.24	0.600	50	1037530000
6	19.05	0.750	50	1037540000
7	22.86	0.900	50	1037550000
8	26.67	1.050	50	1037560000
9	30.48	1.200	50	1037570000
10	34.29	1.350	50	1037580000
11	38.10	1.500	50	1037590000
12	41.91	1.650	50	1037610000
13	45.72	1.800	50	1037620000
14	49.53	1.950	50	1037630000
15	53.34	2.100	50	1037640000
16	57.15	2.250	50	1037650000



### SC 3.81/..../270F

with screw flange

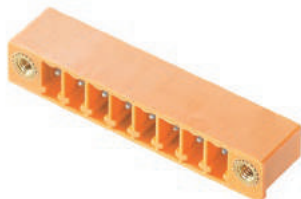

Dimensioned drawing

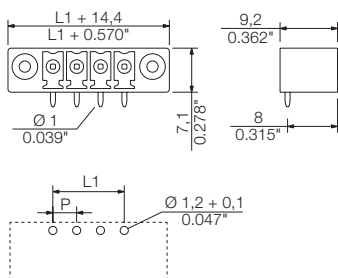

### Ordering data

Solder pin length		3.2 mm		
Colour		Orange		
Pitch		3.81 mm		
Pol.	L1	(inch)	Qty.	Order No.
2	3.81	0.150	50	1038040000
3	7.62	0.300	50	1038050000
4	11.43	0.450	50	1038060000
5	15.24	0.600	50	1038070000
6	19.05	0.750	50	1038080000
7	22.86	0.900	50	1038090000
8	26.67	1.050	50	1038110000
9	30.48	1.200	50	1038130000
10	34.29	1.350	50	1038140000
11	38.10	1.500	50	1038150000
12	41.91	1.650	50	1038160000
13	45.72	1.800	50	1038170000
14	49.53	1.950	50	1038180000
15	53.34	2.100	50	1038190000
16	57.15	2.250	50	1038210000

## Connectors in 3.81 mm pitch Series BC/SC 3.81

### SCD 3.81../90

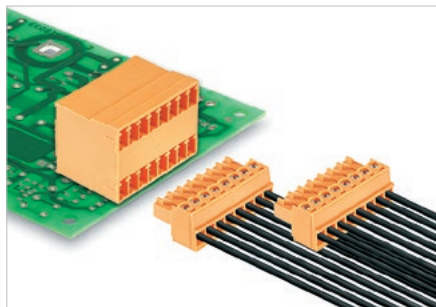

Double-level male header for wave soldering.

- Orientation: 90°
- Connections at the same level with access that is flush over the front of the board.
- Available in closed (G) version and with screw flange (F).

Weidmüller's 3.81 mm pitch (0.15 inch) plug-in connectors are compatible with the layouts of standard connectors and offer space for labelling and coding.

**F**

### Technical data

In compliance with IEC 60664-1 / IEC 61984			
Clamping range, max.			
<b>Solid core H05(07) V-U</b>			
Stranded H07 V-R			
Flexible H05(07) V-K			
Flexible with ferrule			
Ferrule with plastic collar			
Stripping length			
Screwdriver blade	mm		
According to norm			
Tightening torque range			
<b>Rated current, max.</b>	<b>A</b>	<b>17.5</b>	<b>17</b>
At ambient temperature		20°C	40°C
For conductor cross-section			
Overvoltage category		III	III II
Pollution severity		3	2 2
<b>Rated voltage</b>	<b>V</b>	<b>160</b>	<b>160 320</b>
Rated impulse voltage	kV	2.5	2.5 2.5
<b>UL / CUL (Use Group)</b>		<b>B</b>	<b>C D</b>
<b>Rated voltage</b>	<b>V</b>	<b>300</b>	<b>300</b>
<b>Rated current</b>	<b>A</b>	<b>10</b>	<b>10</b>
<b>AWG conductor</b>	<b>AWG</b>		-
<b>CSA (Use Group)</b>		<b>B</b>	<b>C D</b>
Rated voltage	V	300	
Rated current	A	11	
AWG conductor	AWG		-
<b>General data</b>			
Type of insulation material		PA GF	
UL 94 flammability rating		V-0	
Contact base material		Copper alloy	
Material of contact surface		tinned	
Pin dimensions = d	mm	1.0, Octagonal	
Solder eyelet Ø = D	mm	1.2	
Solder eyelet Ø tolerance	mm	+ 0,1	

### Product data

IEC: 320 V / 17.5 A  
UL: 300 V / 10 A



For additional articles and information, refer to [catalog.weidmueller.com](http://catalog.weidmueller.com)

#### Note:

- Additional colours on request
- Rated current related to rated cross-section & min. No. of poles.
- Rated data refer only to the component itself. Clearance and creepage distances to other components are to be designed in accordance with the relevant application standards.
- P on drawing = pitch

### SCD 3.81../90G

closed side



### Dimensioned drawing

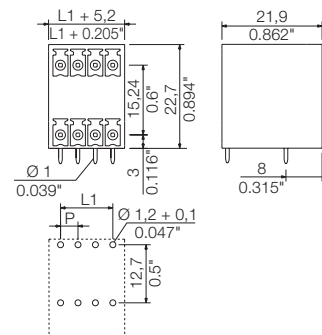

### Accessories

Note: Refer to the Accessories chapter for additional accessories.

Coding	Order No.
SC-SMT 3.81 KO GY BX	1968900000

### Ordering data

Solder pin length		3.2 mm		
Colour		Orange		
Pitch	3.81 mm			
Pol.	L1	(inch)	Qty.	Order No.
4	3.81	0.150	50	1972790000
6	7.62	0.300	50	1972800000
8	11.43	0.450	50	1972810000
10	15.24	0.600	50	1972820000
12	19.05	0.750	50	1972830000
14	22.86	0.900	50	1972840000
16	26.67	1.050	50	1972850000
18	30.48	1.200	50	1972860000
20	34.29	1.350	50	1972870000
22	38.10	1.500	50	1972880000
24	41.91	1.650	50	1972890000
26	45.72	1.800	20	1972900000
28	49.53	1.950	20	1972910000
30	53.34	2.100	20	1972920000
32	57.15	2.250	20	1972930000

SCD 3.81/.. /90F

with screw flange



Dimensioned drawing

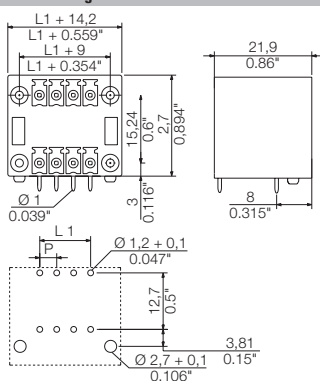

Ordering data

Solder pin length		3.2 mm		
Colour		Orange		
Pitch		3.81 mm		
Pol.	L1	(inch)	Qty.	Order No.
4	3.81	0.150	50	1973260000
6	7.62	0.300	50	1973270000
8	11.43	0.450	50	1973280000
10	15.24	0.600	50	1973290000
12	19.05	0.750	50	1973300000
14	22.86	0.900	50	1973310000
16	26.67	1.050	50	1973320000
18	30.48	1.200	50	1973330000
20	34.29	1.350	50	1973340000
22	38.10	1.500	50	1973350000
24	41.91	1.650	50	1973360000
26	45.72	1.800	20	1973370000
28	49.53	1.950	20	1973380000
30	53.34	2.100	20	1973390000
32	57.15	2.250	20	1973400000

## Connectors in 3.81 mm pitch Series BC/SC 3.81

### SCD 3.81../180

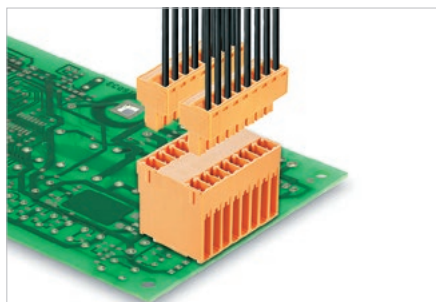

Double-level male header for wave soldering.

- Outlet direction: 180°
- Available in closed (G) version and with screw flange (F).

Weidmüller's 3.81 mm pitch (0.15 inch) plug-in connectors are compatible with the layouts of standard connectors and offer space for labelling and coding.

### Product data

IEC: 320 V / 17.5 A  
UL: 300 V / 10 A



For additional articles and information, refer to [catalog.weidmueller.com](http://catalog.weidmueller.com)

#### Note:

- Additional colours on request
- Rated current related to rated cross-section & min. No. of poles.
- Rated data refer only to the component itself. Clearance and creepage distances to other components are to be designed in accordance with the relevant application standards.
- P on drawing = pitch

### SCD 3.81../180G

closed side



#### Dimensioned drawing

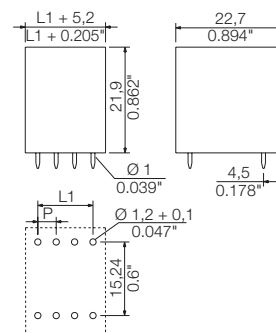

### Technical data

In compliance with IEC 60664-1 / IEC 61984

Clamping range, max.

**Solid core H05(07) V-U**

Stranded H07 V-R

Flexible H05(07) V-K

Flexible with ferrule

Ferrule with plastic collar

Stripping length

Screwdriver blade

mm

According to norm

Tightening torque range

**Rated current, max.**

17.5 17

At ambient temperature

20°C 40°C

For conductor cross-section

Overvoltage category

III III II

Pollution severity

3 2 2

**Rated voltage**

V 160 160 320

Rated impulse voltage

kV 2.5 2.5 2.5

**UL / CUL (Use Group)**

B C D

**Rated voltage**

V 300 300

**Rated current**

A 10 10

**AWG conductor**

AWG -

**CSA (Use Group)**

B C D

Rated voltage

V 300

Rated current

A 11

AWG conductor

AWG -

**General data**

Type of insulation material

PA GF

UL 94 flammability rating

V-0

Contact base material

Copper alloy

Material of contact surface

tinned

Pin dimensions = d

mm 1.0, Octagonal

Solder eyelet Ø = D



mm 1.2

Solder eyelet Ø tolerance

mm + 0,1

### Accessories

Note: Refer to the Accessories chapter for additional accessories.

Coding	Order No.
 SC-SMT 3.81 KO GY BX	1968900000
<b>Mounting screw</b>	
 PTSC KA 2.2X4.5 WN1412	1610740000

### Ordering data

Solder pin length		3.2 mm		
Colour		Orange		
Pitch	3.81 mm			
Pol.	L1	(inch)	Qty.	Order No.
4	3.81	0.150	50	1029920000
6	7.62	0.300	50	1029940000
8	11.43	0.450	50	1029950000
10	15.24	0.600	50	1029960000
12	19.05	0.750	50	1029970000
14	22.86	0.900	50	1029980000
16	26.67	1.050	50	1029990000
18	30.48	1.200	50	1030010000
20	34.29	1.350	50	1030020000
22	38.10	1.500	50	1030030000
24	41.91	1.650	50	1030040000
26	45.72	1.800	20	1030050000
28	49.53	1.950	20	1030060000
30	53.34	2.100	20	1030070000
32	57.15	2.250	20	1030080000

## SCD 3.81/..../180F

with screw flange



### Dimensioned drawing

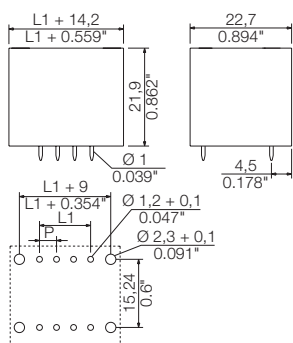

### Ordering data

Solder pin length		3.2 mm		
Colour		Orange		
Pitch		3.81 mm		
Pol.	L1	(inch)	Qty.	Order No.
4	3.81	0.150	50	1030440000
6	7.62	0.300	50	1030450000
8	11.43	0.450	50	1030460000
10	15.24	0.600	50	1030470000
12	19.05	0.750	50	1030480000
14	22.86	0.900	50	1030490000
16	26.67	1.050	50	1030510000
18	30.48	1.200	50	1030520000
20	34.29	1.350	50	1030530000
22	38.10	1.500	50	1030540000
24	41.91	1.650	50	1030550000
26	45.72	1.800	20	1030560000
28	49.53	1.950	20	1030570000
30	53.34	2.100	20	1030580000
32	57.15	2.250	20	1030590000

## Connectors in 3.81 mm pitch Series BC/SC 3.81

### SCDN 3.81../90

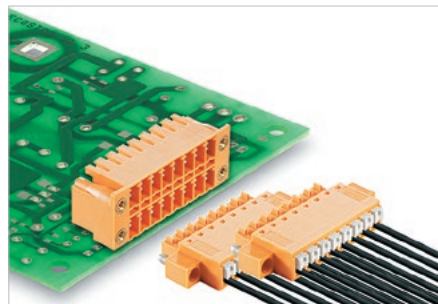

Compact double-level male header for wave soldering.

- For use with BCF 3.81 (PUSH IN) plugs.
- Orientation: 90°
- Designed for front panel applications.
- Available in closed (G) version or with screw flange (F).

Weidmüller's 3.81 mm pitch (0.15 inch) plug-in connectors are compatible with the layouts of standard connectors and offer space for labelling and coding.

### Product data

IEC: 320 V / 17.5 A  
UL: 300 V / 10 A



For additional articles and information, refer to [catalog.weidmueller.com](http://catalog.weidmueller.com)

#### Note:

- Additional colours on request
- Rated current related to rated cross-section & min. No. of poles.
- Rated data refer only to the component itself. Clearance and creepage distances to other components are to be designed in accordance with the relevant application standards.
- P on drawing = pitch

### SCDN 3.81../90G

closed side



#### Dimensioned drawing

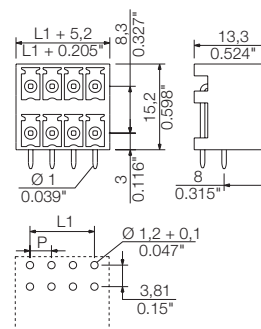

### Technical data

#### In compliance with IEC 60664-1 / IEC 61984

Clamping range, max.			
<b>Solid core H05(07) V-U</b>			
Stranded H07 V-R			
Flexible H05(07) V-K			
Flexible with ferrule			
Ferrule with plastic collar			
Stripping length			
Screwdriver blade	mm		
According to norm			
Tightening torque range			
<b>Rated current, max.</b>	<b>A</b>	<b>17.5</b>	<b>17</b>
At ambient temperature		20°C	40°C
For conductor cross-section			
Overvoltage category		III	III
Pollution severity		3	2
<b>Rated voltage</b>	<b>V</b>	<b>160</b>	<b>160</b>
Rated impulse voltage	kV	2.5	2.5
<b>UL / CUL (Use Group)</b>	<b>B</b>	<b>C</b>	<b>D</b>
<b>Rated voltage</b>	<b>V</b>	<b>300</b>	<b>300</b>
<b>Rated current</b>	<b>A</b>	<b>10</b>	<b>10</b>
<b>AWG conductor</b>	<b>AWG</b>	-	-
<b>CSA (Use Group)</b>	<b>B</b>	<b>C</b>	<b>D</b>
Rated voltage	V	300	300
Rated current	A	11	11
AWG conductor	AWG	-	-
<b>General data</b>			
Type of insulation material		PA GF	
UL 94 flammability rating		V-0	
Contact base material		Copper alloy	
Material of contact surface		tinned	
Pin dimensions = d	mm	1.0, Octagonal	
Solder eyelet Ø = D	mm	1.2	
Solder eyelet Ø tolerance	mm	+ 0,1	

### Accessories

Note: Refer to the Accessories chapter for additional accessories.

Coding	Order No.
SC-SMT 3.81 KO GY BX	1968900000

### Ordering data

Solder pin length		3.2 mm		
Colour		Orange		
Pitch	3.81 mm	Qty.	Order No.	
4	3.81	50	1040410000	
6	7.62	50	1040420000	
8	11.43	50	1040430000	
10	15.24	50	1040440000	
12	19.05	50	1040450000	
14	22.86	50	1040460000	
16	26.67	50	1040470000	
18	30.48	50	1040490000	
20	34.29	50	1040510000	
22	38.10	50	1040520000	
24	41.91	50	1040530000	
26	45.72	20	1040540000	
28	49.53	20	1040550000	
30	53.34	20	1040560000	
32	57.15	20	1040570000	

3.81

90°

## SCDN 3.81../90F

with screw flange



### Dimensioned drawing

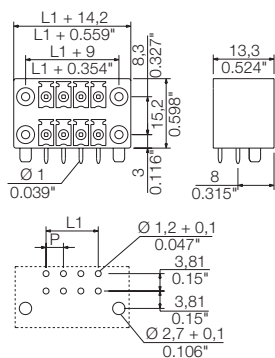

### Ordering data

Solder pin length		3.2 mm		
Colour		Orange		
Pitch		3.81 mm		
Pol.	L1	(inch)	Qty.	Order No.
4	3.81	0.150	50	1040960000
6	7.62	0.300	50	1040970000
8	11.43	0.450	50	1040980000
10	15.24	0.600	50	1040990000
12	19.05	0.750	50	1041000000
14	22.86	0.900	50	1041010000
16	26.67	1.050	50	1041020000
18	30.48	1.200	50	1041030000
20	34.29	1.350	50	1041040000
22	38.10	1.500	50	1041050000
24	41.91	1.650	50	1041060000
26	45.72	1.800	20	1041070000
28	49.53	1.950	20	1041080000
30	53.34	2.100	20	1041090000
32	57.15	2.250	20	1041100000

## Connectors in 3.81 mm pitch Series BC/SC 3.81

### SCDV 3.81../90

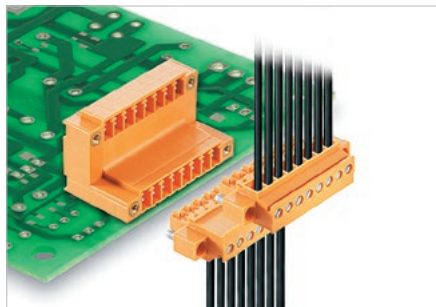

Double level male header for wave soldering.

- Orientation: 90°
- Connections at two offset levels with open access to each row.
- Available in closed (G) version or with screw flange (F).

Weidmüller's 3.81 mm pitch (0.15 inch) plug-in connectors are compatible with the layouts of standard connectors and offer space for labelling and coding.

### Product data

IEC: 320 V / 17.5 A  
UL: 300 V / 10 A



For additional articles and information, refer to [catalog.weidmueller.com](http://catalog.weidmueller.com)

#### Note:

- Additional colours on request
- Rated current related to rated cross-section & min. No. of poles.
- Rated data refer only to the component itself. Clearance and creepage distances to other components are to be designed in accordance with the relevant application standards.
- P on drawing = pitch

### SCDV 3.81../90G

closed side



#### Dimensioned drawing

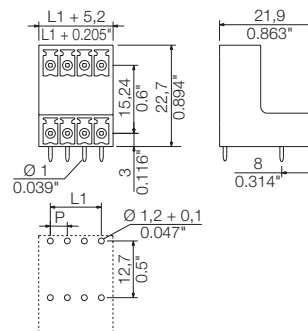

### Technical data

#### In compliance with IEC 60664-1 / IEC 61984

Clamping range, max.			
<b>Solid core H05(07) V-U</b>			
Stranded H07 V-R			
Flexible H05(07) V-K			
Flexible with ferrule			
Ferrule with plastic collar			
Stripping length			
Screwdriver blade	mm		
According to norm			
Tightening torque range			
<b>Rated current, max.</b>		<b>17.5</b>	<b>17</b>
At ambient temperature		20°C	40°C
For conductor cross-section			
Overvoltage category		III	III II
Pollution severity		3	2 2
<b>Rated voltage</b>	<b>V</b>	<b>160</b>	<b>160 320</b>
Rated impulse voltage	kV	2.5	2.5 2.5
<b>UL / CUL (Use Group)</b>		<b>B</b>	<b>C D</b>
<b>Rated voltage</b>	<b>V</b>	<b>300</b>	<b>300</b>
<b>Rated current</b>	<b>A</b>	<b>10</b>	<b>10</b>
<b>AWG conductor</b>	<b>AWG</b>		
<b>CSA (Use Group)</b>		<b>B</b>	<b>C D</b>
Rated voltage	V	300	300
Rated current	A	11	11
AWG conductor	AWG		
<b>General data</b>			
Type of insulation material		PA GF	
UL 94 flammability rating		V-0	
Contact base material		Copper alloy	
Material of contact surface		tinned	
Pin dimensions = d	mm	1.0, Octagonal	
Solder eyelet Ø = D	mm	1.2	
Solder eyelet Ø tolerance	mm	+ 0,1	

### Accessories

Note: Refer to the Accessories chapter for additional accessories.

Coding	Order No.
SC-SMT 3.81 KO GY BX	1968900000

### Ordering data

Solder pin length		3.2 mm		
Colour		Orange		
Pitch	3.81 mm	Qty.	Order No.	
4	3.81	50	1032090000	
6	7.62	50	1032110000	
8	11.43	50	1032120000	
10	15.24	50	1032130000	
12	19.05	50	1032140000	
14	22.86	50	1032150000	
16	26.67	50	1032160000	
18	30.48	50	1032170000	
20	34.29	50	1032190000	
22	38.10	50	1032200000	
24	41.91	50	1032210000	
26	45.72	20	1032220000	
28	49.53	20	1032230000	
30	53.34	20	1032240000	
32	57.15	20	1032250000	

3.81

90°



SCDV 3.81/./90F

with screw flange



Dimensioned drawing

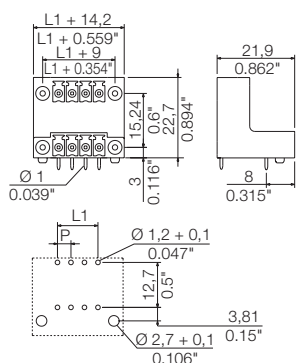

Ordering data

Solder pin length		3.2 mm		
Colour		Orange		
Pitch		3.81 mm		
Pol.	L1	(inch)	Qty.	Order No.
4	3.81	0.150	50	1032580000
6	7.62	0.300	50	1032590000
8	11.43	0.450	50	1032600000
10	15.24	0.600	50	1032610000
12	19.05	0.750	50	1032620000
14	22.86	0.900	50	1032630000
16	26.67	1.050	50	1032640000
18	30.48	1.200	50	1032650000
20	34.29	1.350	50	1032660000
22	38.10	1.500	50	1032670000
24	41.91	1.650	50	1032680000
26	45.72	1.800	20	1032690000
28	49.53	1.950	20	1032710000
30	53.34	2.100	20	1032720000
32	57.15	2.250	20	1032730000

## Connectors in 3.81 mm pitch Series BC/SC 3.81

### SCDV 3.81../180

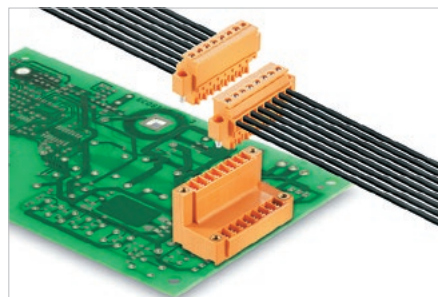

Double-level male header for wave soldering.

- Orientation: 180°.
- Connections at two offset levels with open access to each row.
- Available in closed (G) version or with screw flange (F).

Weidmüller's 3.81 mm pitch (0.15 inch) plug-in connectors are compatible with the layouts of standard connectors and offer space for labelling and coding.

### Product data

IEC: 320 V / 17.5 A  
UL: 300 V / 10 A



For additional articles and information, refer to [catalog.weidmueller.com](http://catalog.weidmueller.com)

#### Note:

- Additional colours on request
- Rated current related to rated cross-section & min. No. of poles.
- Rated data refer only to the component itself. Clearance and creepage distances to other components are to be designed in accordance with the relevant application standards.
- P on drawing = pitch
- Rated data refer only to the component itself. Clearance and creepage distances to other components are to be designed in accordance with the relevant application standards.
- For additional mechanical support for male connectors with screw flange (...F), we recommend an additional cable gland with fastening screws (sheet metal screw ISO 1481-ST 2.2x4.5 C or ISO 7049-ST 2.2x4.5 C - see Accessories). Cable gland only permitted before soldering.

### SCDV 3.81../180G

closed side



#### Dimensioned drawing

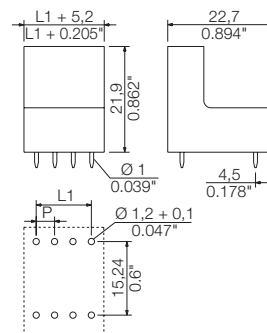

### Technical data

In compliance with IEC 60664-1 / IEC 61984

Clamping range, max.			
<b>Solid core H05(07) V-U</b>			
Stranded H07 V-R			
Flexible H05(07) V-K			
Flexible with ferrule			
Ferrule with plastic collar			
Stripping length			
Screwdriver blade	mm		
According to norm			
Tightening torque range			
<b>Rated current, max.</b>		<b>17.5</b>	<b>17</b>
At ambient temperature		20°C	40°C
For conductor cross-section			
Overvoltage category		III	III II
Pollution severity		3	2 2
<b>Rated voltage</b>	<b>V</b>	<b>160</b>	<b>160 320</b>
Rated impulse voltage	kV	2.5	2.5 2.5
<b>UL / CUL (Use Group)</b>		<b>B</b>	<b>C D</b>
<b>Rated voltage</b>	<b>V</b>	<b>300</b>	<b>300</b>
<b>Rated current</b>	<b>A</b>	<b>10</b>	<b>10</b>
<b>AWG conductor</b>	<b>AWG</b>		
<b>CSA (Use Group)</b>		<b>B</b>	<b>C D</b>
Rated voltage	V	300	300
Rated current	A	11	11
AWG conductor	AWG		
<b>General data</b>			
Type of insulation material		PA GF	
UL 94 flammability rating		V-0	
Contact base material		Copper alloy	
Material of contact surface		tinned	
Pin dimensions = d	mm	1.0, Octagonal	
Solder eyelet Ø = D	mm	1.2	
Solder eyelet Ø tolerance	mm	+ 0,1	

### Accessories

Note: Refer to the Accessories chapter for additional accessories.

Coding	Order No.
SC-SMT 3.81 KO GY BX	<b>1968900000</b>
<b>Mounting screw</b>	
PTSC KA 2.2X4.5 WN1412	<b>1610740000</b>

### Ordering data

Solder pin length		3.2 mm		
Colour		Orange		
Pitch	3.81 mm			
Pol.	L1	(inch)	Qty.	Order No.
4	3.81	0.150	50	<b>1034470000</b>
6	7.62	0.300	50	<b>1034490000</b>
8	11.43	0.450	50	<b>1034510000</b>
10	15.24	0.600	50	<b>1034520000</b>
12	19.05	0.750	50	<b>1034530000</b>
14	22.86	0.900	50	<b>1034540000</b>
16	26.67	1.050	50	<b>1034550000</b>
18	30.48	1.200	50	<b>1034560000</b>
20	34.29	1.350	50	<b>1034570000</b>
22	38.10	1.500	50	<b>1034580000</b>
24	41.91	1.650	50	<b>1034590000</b>
26	45.72	1.800	20	<b>1034610000</b>
28	49.53	1.950	20	<b>1034620000</b>
30	53.34	2.100	20	<b>1034630000</b>
32	57.15	2.250	20	<b>1034640000</b>

3.81

180°

**SCDV 3.81../180F**

with screw flange



**Dimensioned drawing**

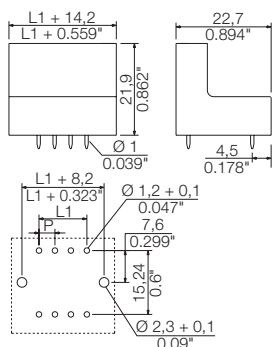

**Ordering data**

Solder pin length		3.2 mm		
Colour		Orange		
Pitch		3.81 mm		
Pol.	L1	(inch)	Qty.	Order No.
4	3.81	0.150	50	1034980000
6	7.62	0.300	50	1034990000
8	11.43	0.450	50	1035010000
10	15.24	0.600	50	1035020000
12	19.05	0.750	50	1035030000
14	22.86	0.900	50	1035040000
16	26.67	1.050	50	1035050000
18	30.48	1.200	50	1035060000
20	34.29	1.350	50	1035070000
22	38.10	1.500	50	1035080000
24	41.91	1.650	50	1035090000
26	45.72	1.800	20	1035110000
28	49.53	1.950	20	1035120000
30	53.34	2.100	20	1035130000
32	57.15	2.250	20	1035140000

### SCZ 3.81../180



Inverted male plug with screw connection:

- Wire-to-wire connection with the BCZ female plug
- Board-to-wire connection with the BCL-SMT female header.
- Available in closed (G) version, screw flange (F), inverted flange (FI) and with lock and release lever (LR).

Weidmüller's 3.81 mm pitch (0.15 inch) plug-in connectors are compatible with the layouts of standard connectors and offer space for labelling and coding.

### Product data

IEC: 320 V / 17.5 A / 0.2 - 1.5 mm<sup>2</sup>  
UL: 300 V / 10 A / AWG 28 - 16



For additional articles and information, refer to [catalog.weidmuller.com](http://catalog.weidmuller.com)

#### Note:

- Additional colours on request
- Rated current related to rated cross-section & min. No. of poles.
- Wire end ferrule with plastic collar to DIN 46228/4
- P on drawing = pitch
- Rated data refer only to the component itself. Clearance and creepage distances to other components are to be designed in accordance with the relevant application standards.

### SCZ 3.81../180G

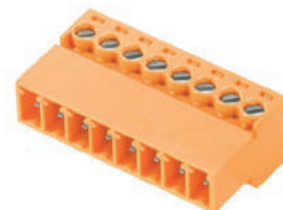

#### Dimensioned drawing

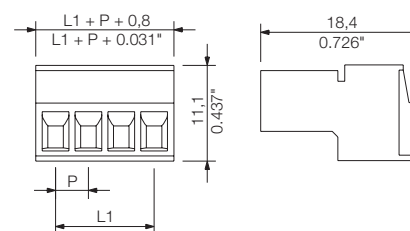

### Ordering data

Solder pin length				
Colour	Orange			
Pitch	3.81 mm			
Pol.	L1	(inch)	Qty.	Order No.
2	3.81	0.150	50	1969520000
3	7.62	0.300	50	1969540000
4	11.43	0.450	50	1969560000
5	15.24	0.600	50	1969570000
6	19.05	0.750	50	1969580000
7	22.86	0.900	50	1969590000
8	26.67	1.050	50	1969610000
9	30.48	1.200	50	1969630000
10	34.29	1.350	50	1969640000
11	38.10	1.500	50	1969660000
12	41.91	1.650	50	1969670000

### Representative deratings curve

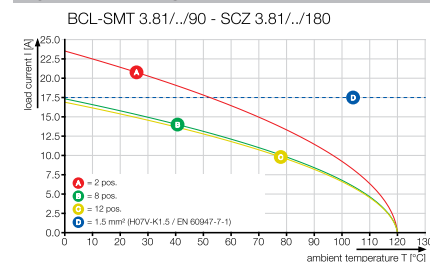

### Technical data

In compliance with IEC 60664-1 / IEC 61984			
Clamping range, max.	mm <sup>2</sup>	0.08...1.5	
<b>Solid core H05(07) V-U</b>	<b>mm<sup>2</sup></b>	<b>0.2...1.5</b>	
Stranded H07 V-R			
Flexible H05(07) V-K	mm <sup>2</sup>	0.2...1.5	
Flexible with ferrule	mm <sup>2</sup>	0.2...1.5	
Ferrule with plastic collar	mm <sup>2</sup>	0.2...1.5	
Stripping length	mm	7	
Screwdriver blade	mm	0.4 x 2.5	
According to norm		DIN 5264	
Tightening torque range	Nm	0.2...0.25	
<b>Rated current, max.</b>	<b>A</b>	<b>17.5</b>	<b>17.5</b>
At ambient temperature		20°C	40°C
For conductor cross-section	mm <sup>2</sup>	1	
Overvoltage category		III	III II
Pollution severity		3	2 2
<b>Rated voltage</b>	<b>V</b>	<b>160</b>	<b>160 320</b>
Rated impulse voltage	kV	2.5	2.5 2.5
<b>UL / CUL (Use Group)</b>	<b>B C D</b>		
<b>Rated voltage</b>	<b>V</b>	<b>300</b>	<b>300</b>
<b>Rated current</b>	<b>A</b>	<b>10</b>	<b>10</b>
<b>AWG conductor</b>	<b>AWG</b>	<b>28-16</b>	
<b>CSA (Use Group)</b>	<b>B C D</b>		
Rated voltage	V	300	50
Rated current	A	11	11
AWG conductor	AWG	28-16	
<b>General data</b>			
Type of insulation material		PA 66 GF 30	
UL 94 flammability rating		V-0	
Contact base material		Copper alloy	
Material of contact surface		tinned	
Pin dimensions = d	mm		
Solder eyelet Ø = D	mm		
Solder eyelet Ø tolerance	mm		

### Accessories

Note: Refer to the Accessories chapter for additional accessories.

Coding	Order No.
SC-SMT 3.81 KO GY BX	1968900000
<b>Screwdriver</b>	
SDS 0.4X2.5X75	9009030000
SDIS 0.4X2.5X75	9008370000

SCZ 3.81../180F

with screw flange



Dimensioned drawing

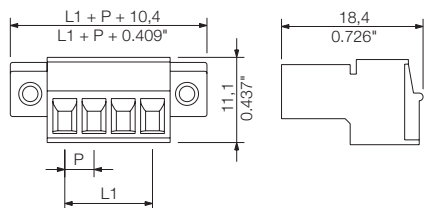

Ordering data

Solder pin length					
Colour					Orange
Pitch 3.81 mm					
Pol.	L1	(inch)	Qty.	Order No.	
2	3.81	0.150	50	1970910000	
3	7.62	0.300	50	1970920000	
4	11.43	0.450	50	1970930000	
5	15.24	0.600	50	1970940000	
6	19.05	0.750	50	1970960000	
7	22.86	0.900	50	1970970000	
8	26.67	1.050	50	1970980000	
9	30.48	1.200	50	1970990000	
10	34.29	1.350	50	1971000000	
11	38.10	1.500	50	1971010000	
12	41.91	1.650	50	1971020000	

SCZ 3.81../180FI

with inverted flange



Dimensioned drawing

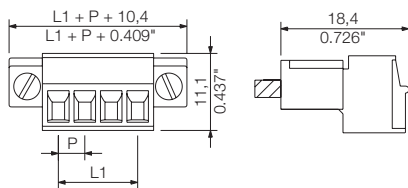

Ordering data

Solder pin length					
Colour					Orange
Pitch 3.81 mm					
Pol.	L1	(inch)	Qty.	Order No.	
2	3.81	0.150	50	1970260000	
3	7.62	0.300	50	1970270000	
4	11.43	0.450	50	1970310000	
5	15.24	0.600	50	1970320000	
6	19.05	0.750	50	1970340000	
7	22.86	0.900	50	1970350000	
8	26.67	1.050	50	1970360000	
9	30.48	1.200	50	1970390000	
10	34.29	1.350	50	1970410000	
11	38.10	1.500	50	1970420000	
12	41.91	1.650	50	1970430000	

SCZ 3.81../180LR

with screw flange



Dimensioned drawing

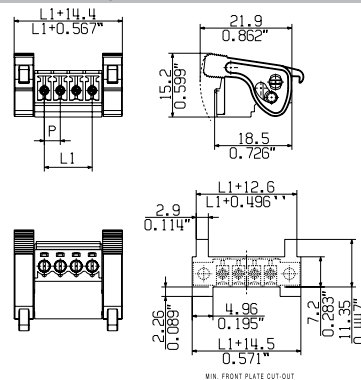

Ordering data

Solder pin length					
Colour					Orange
Pitch 3.81 mm					
Pol.	L1	(inch)	Qty.	Order No.	
2	3.81	0.150	50	2442050000	
3	7.62	0.300	50	2444060000	
4	11.43	0.450	50	2444090000	
5	15.24	0.600	50	2444100000	
6	19.05	0.750	50	2444110000	
7	22.86	0.900	50	2444120000	
8	26.67	1.050	50	2444130000	
9	30.48	1.200	50	2444140000	
10	34.29	1.350	50	2444150000	
11	38.10	1.500	50	2444160000	
12	41.91	1.650	50	2444170000	

Additional deratings curves

BCL-SMT 3.81../180 - SCZ 3.81../180

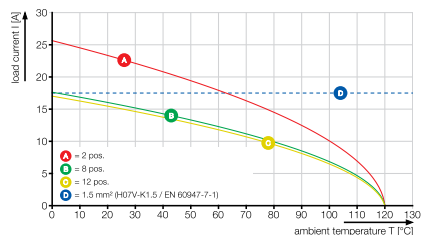

BCZ 3.81../180 - SCZ 3.81../180

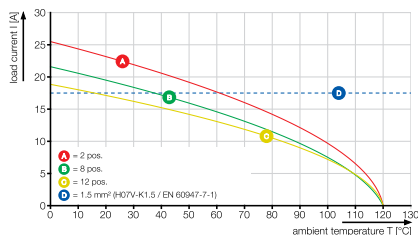

## Connectors in 3.81 mm pitch Series BC/SC 3.81

### SCZ 3.81../180 ZE



Inverted male plug with screw connection and strain relief for the connected wire.

- Wire-to-wire connection with female plugs.
- Board-to-wire connection with BCL-SMT female header.
- Available in closed (G) version, screw flange (F), inverted flange (FI) and with lock and release lever (LR).

Weidmüller's 3.81 mm pitch (0.15 inch) plug-in connectors are compatible with the layouts of standard connectors and offer space for labelling and coding.

### Product data

IEC: 320 V / 17.5 A / 0.2 - 1.5 mm<sup>2</sup>  
UL: 300 V / 10 A / AWG 28 - 16



For additional articles and information, refer to [catalog.weidmueller.com](http://catalog.weidmueller.com)

#### Note:

- Additional colours on request
- Rated current related to rated cross-section & min. No. of poles.
- Wire end ferrule with plastic collar to DIN 46228/4
- P on drawing = pitch
- Rated data refer only to the component itself. Clearance and creepage distances to other components are to be designed in accordance with the relevant application standards.

### SCZ 3.81../180GZE

with strain relief



#### Dimensioned drawing

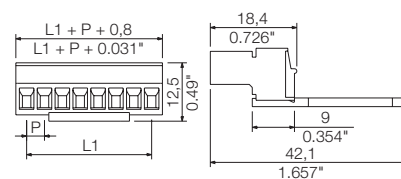

### Technical data

#### In compliance with IEC 60664-1 / IEC 61984

Clamping range, max.	mm <sup>2</sup>	0.08...1.5
<b>Solid core H05(07) V-U</b>	<b>mm<sup>2</sup></b>	<b>0.2...1.5</b>
Stranded H07 V-R		
Flexible H05(07) V-K	mm <sup>2</sup>	0.2...1.5
Flexible with ferrule	mm <sup>2</sup>	0.2...1.5
Ferrule with plastic collar	mm <sup>2</sup>	0.2...1.5
Stripping length	mm	7
Screwdriver blade	mm	0.4 x 2.5
According to norm		DIN 5264
Tightening torque range	Nm	0.2...0.25
<b>Rated current, max.</b>	<b>A</b>	<b>17.5 17.5</b>
At ambient temperature	20°C	40°C
For conductor cross-section	mm <sup>2</sup>	1
Overvoltage category		III III II
Pollution severity		3 2 2
<b>Rated voltage</b>	<b>V</b>	<b>160 160 320</b>
Rated impulse voltage	kV	2.5 2.5 2.5
<b>UL / CUL (Use Group)</b>	<b>B C D</b>	
<b>Rated voltage</b>	<b>V</b>	<b>300 300</b>
<b>Rated current</b>	<b>A</b>	<b>10 10</b>
<b>AWG conductor</b>	<b>AWG</b>	<b>28-16</b>
<b>CSA (Use Group)</b>	<b>B C D</b>	
Rated voltage	V	300 50
Rated current	A	11 11
AWG conductor	AWG	28-16
<b>General data</b>		
Type of insulation material		PA 66 GF 30
UL 94 flammability rating		V-0
Contact base material		Copper alloy
Material of contact surface		tinned
Pin dimensions = d	mm	
Solder eyelet Ø = D	mm	
Solder eyelet Ø tolerance	mm	

### Accessories

Note: Refer to the Accessories chapter for additional accessories.

Coding	Order No.
SC-SMT 3.81 KO GY BX	1968900000
<b>Screwdriver</b>	
SDS 0.4X2.5X75	9009030000
SDIS 0.4X2.5X75	9008370000

### Ordering data

Solder pin length				
Colour	Orange			
Pitch	3.81 mm		Qty.	Order No.
Pol.	L1	(inch)		
4	11.43	0.450	50	1237000000
5	15.24	0.600	50	1237010000
6	19.05	0.750	50	1237020000
7	22.86	0.900	50	1237030000
8	26.67	1.050	50	1237040000
9	30.48	1.200	50	1237070000
10	34.29	1.350	50	1237080000
11	38.10	1.500	50	1237090000
12	41.91	1.650	50	1237100000

from 10 pole 2 strain reliefs per plug-in connector

### Representative deratings curve

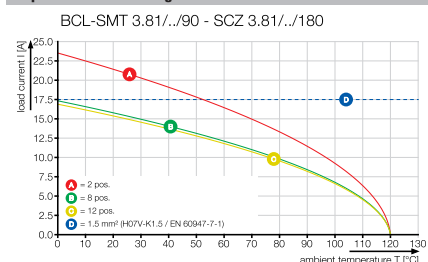

from 10 pole 2 strain reliefs per plug-in connector

SCZ 3.81../180FZE

with screw flange and strain relief



Dimensioned drawing

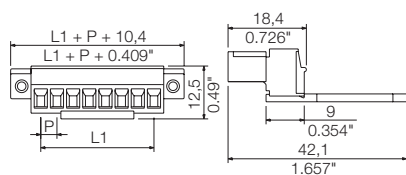

Ordering data

Solder pin length					
Colour		Orange			
Pitch 3.81 mm					
Pol.	L1	(inch)	Qty.	Order No.	
4	11.43	0.450	50	1237120000	
5	15.24	0.600	50	1237130000	
6	19.05	0.750	50	1237140000	
7	22.86	0.900	50	1237170000	
8	26.67	1.050	50	1237180000	
9	30.48	1.200	50	1237190000	
10	34.29	1.350	50	1237200000	
11	38.10	1.500	50	1237210000	
12	41.91	1.650	50	1237220000	

SCZ 3.81../180FZE

with inverted screw flange and strain relief



Dimensioned drawing

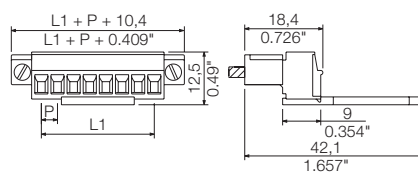

Ordering data

Solder pin length					
Colour		Orange			
Pitch 3.81 mm					
Pol.	L1	(inch)	Qty.	Order No.	
4	11.43	0.450	50	1237550000	
5	15.24	0.600	50	1237560000	
6	19.05	0.750	50	1237570000	
7	22.86	0.900	50	1237580000	
8	26.67	1.050	50	1237590000	
9	30.48	1.200	50	1237610000	
10	34.29	1.350	50	1237620000	
11	38.10	1.500	50	1237630000	
12	41.91	1.650	50	1237640000	

SCZ 3.81../180LRZE



Dimensioned drawing

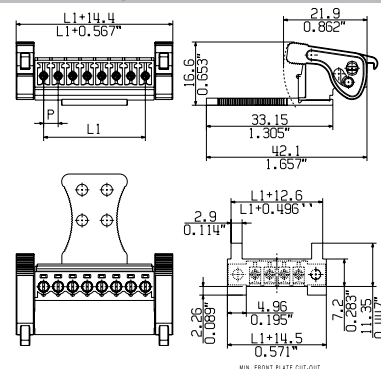

Ordering data

Solder pin length					
Colour		Orange			
Pitch 3.81 mm					
Pol.	L1	(inch)	Qty.	Order No.	
4	11.43	0.450	50	2444240000	
5	15.24	0.600	50	2444220000	
6	19.05	0.750	50	2444270000	
7	22.86	0.900	50	2444200000	
8	26.67	1.050	50	2444260000	
9	30.48	1.200	50	2444230000	
10	34.29	1.350	50	2444290000	
11	38.10	1.500	50	2444250000	
12	41.91	1.650	50	2444280000	

from 10 pole 2 strain reliefs per plug-in connector

from 10 pole 2 strain reliefs per plug-in connector

Additional deratings curves

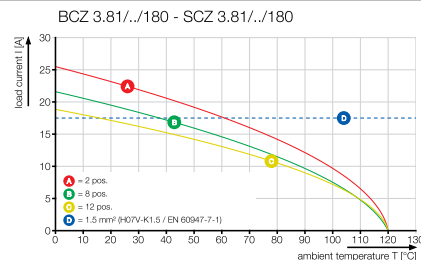
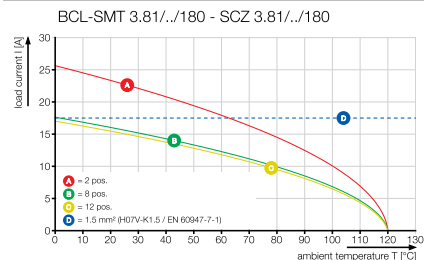

### BCZ 3.81../180

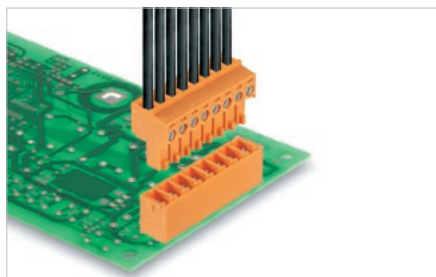

Female plug with screw connection. Wire outlet 180° (wire is straight on to the direction of plugging).

- Available in closed version, with screw flange (F) and lock and release-lever (LR).

Weidmüller's 3.81 mm pitch (0.15 inch) plug-in connectors are compatible with the layouts of standard connectors and offer space for labelling and coding.

### Product data

IEC: 320 V / 17.5 A / 0.2 - 1.5 mm<sup>2</sup>  
UL: 300 V / 10 A / AWG 28 - 16



For additional articles and information, refer to [catalog.weidmueller.com](http://catalog.weidmueller.com)

#### Note:

- Additional colours on request
- Rated current related to rated cross-section & min. No. of poles.
- Wire end ferrule without plastic collar to DIN 46228/1
- Wire end ferrule with plastic collar to DIN 46228/4
- P on drawing = pitch
- Rated data refer only to the component itself. Clearance and creepage distances to other components are to be designed in accordance with the relevant application standards.

### BCZ 3.81../180



#### Dimensioned drawing

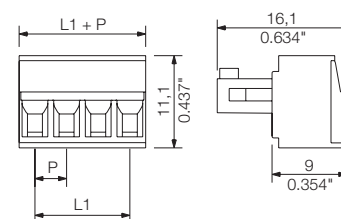

### Technical data

In compliance with IEC 60664-1 / IEC 61984			
Clamping range, max.	mm <sup>2</sup>	0.08...1.5	
<b>Solid core H05(07) V-U</b>	<b>mm<sup>2</sup></b>	<b>0.2...1.5</b>	
Stranded H07 V-R			
Flexible H05(07) V-K	mm <sup>2</sup>	0.2...1.5	
Flexible with ferrule	mm <sup>2</sup>	0.2...1.5	
Ferrule with plastic collar	mm <sup>2</sup>	0.2...1.5	
Stripping length	mm	7	
Screwdriver blade	mm	0.4 x 2.5	
According to norm		DIN 5264	
Tightening torque range	Nm	0.2...0.25	
<b>Rated current, max.</b>	<b>A</b>	<b>17.5</b>	<b>17</b>
At ambient temperature		20°C	40°C
For conductor cross-section	mm <sup>2</sup>	1	
Overvoltage category		III	III II
Pollution severity		3	2 2
<b>Rated voltage</b>	<b>V</b>	<b>160</b>	<b>160 320</b>
Rated impulse voltage	kV	2.5	2.5 2.5
<b>UL / CUL (Use Group)</b>		<b>B</b>	<b>C D</b>
<b>Rated voltage</b>	<b>V</b>	<b>300</b>	<b>300</b>
<b>Rated current</b>	<b>A</b>	<b>10</b>	<b>10</b>
<b>AWG conductor</b>	<b>AWG</b>	<b>28-16</b>	
<b>CSA (Use Group)</b>		<b>B</b>	<b>C D</b>
Rated voltage	V	300	50
Rated current	A	8	8
AWG conductor	AWG	28-16	
General data			
Type of insulation material		PA 66 GF 30	
UL 94 flammability rating		V-0	
Contact base material		Copper alloy	
Material of contact surface		tinned	
Pin dimensions = d	mm		
Solder eyelet Ø = D	mm		
Solder eyelet Ø tolerance	mm		

### Accessories

Note: Refer to the Accessories chapter for additional accessories.

Cover hood	Order No.
BCZ 3.81 AH03 BK BX	1005280000
BCZ 3.81 AH04 BK BX	1005290000
BCZ 3.81 AH05 BK BX	1005300000
BCZ 3.81 AH06 BK BX	1005310000
BCZ 3.81 AH07 BK BX	1005320000
BCZ 3.81 AH08 BK BX	1005330000
BCZ 3.81 AH09 BK BX	1005340000
BCZ 3.81 AH10 BK BX	1005350000
BCZ 3.81 AH12 BK BX	1005370000
BCZ 3.81 AH13 BK BX	1005380000
BCZ 3.81 AH14 BK BX	1005390000
BCZ 3.81 AH15 BK BX	1005400000
BCZ 3.81 AH16 BK BX	1005410000
Screwdriver	
SDS 0.4X2.5X75	9009030000
SDIS 0.4X2.5X75	9008370000

### Ordering data

Solder pin length				
Colour	Orange			
Pitch	3.81 mm			
Pol.	L1	(inch)	Qty.	Order No.
2	3.81	0.150	50	1940730000
3	7.62	0.300	50	1940740000
4	11.43	0.450	50	1940750000
5	15.24	0.600	50	1940760000
6	19.05	0.750	50	1940770000
7	22.86	0.900	50	1940780000
8	26.67	1.050	50	1940790000
9	30.48	1.200	50	1940800000
10	34.29	1.350	50	1940810000
11	38.10	1.500	50	1940820000
12	41.91	1.650	50	1940830000
13	45.72	1.800	50	1940840000
14	49.53	1.950	50	1940850000
15	53.34	2.100	50	1940860000
16	57.15	2.250	50	1940870000
17	60.96	2.400	50	1940890000
18	64.77	2.550	50	1940900000
19	68.58	2.700	50	1940910000
20	72.39	2.850	50	1940920000

### Representative deratings curve

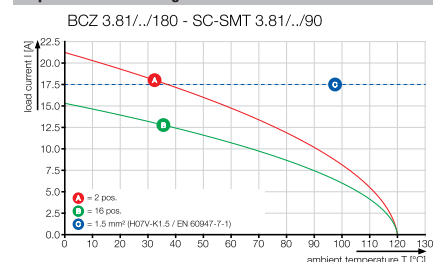



### BCZ 3.81../180F

with screw flange



Dimensioned drawing

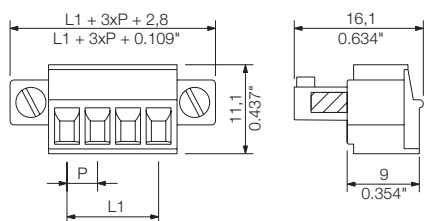

### Ordering data

Solder pin length					
Colour					Orange
Pitch 3.81 mm					
Pol.	L1	(inch)	Qty.	Order No.	
2	3.81	0.150	50	1941010000	
3	7.62	0.300	50	1941020000	
4	11.43	0.450	50	1941030000	
5	15.24	0.600	50	1941040000	
6	19.05	0.750	50	1941050000	
7	22.86	0.900	50	1941060000	
8	26.67	1.050	50	1941070000	
9	30.48	1.200	50	1941080000	
10	34.29	1.350	50	1941090000	
11	38.10	1.500	50	1941100000	
12	41.91	1.650	50	1941110000	
13	45.72	1.800	50	1941120000	
14	49.53	1.950	50	1941130000	
15	53.34	2.100	50	1941140000	
16	57.15	2.250	50	1941150000	
17	60.96	2.400	50	1941160000	
18	64.77	2.550	50	1941170000	
19	68.58	2.700	50	1941180000	
20	72.39	2.850	50	1941190000	

### BCZ 3.81../180LR



Dimensioned drawing

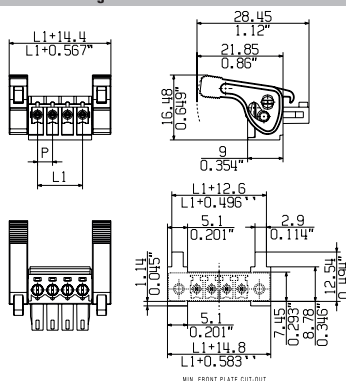

### Ordering data

Solder pin length					
Colour					Orange
Pitch 3.81 mm					
Pol.	L1	(inch)	Qty.	Order No.	
2	3.81	0.150	50	2442360000	
3	7.62	0.300	50	2442370000	
4	11.43	0.450	50	2442310000	
5	15.24	0.600	50	2442320000	
6	19.05	0.750	50	2442330000	
7	22.86	0.900	50	2442340000	
8	26.67	1.050	50	2442380000	
9	30.48	1.200	50	2442390000	
10	34.29	1.350	50	2442400000	
11	38.10	1.500	50	2442350000	
12	41.91	1.650	50	2442410000	
13	45.72	1.800	50	2442460000	
14	49.53	1.950	50	2442420000	
15	53.34	2.100	50	2442430000	
16	57.15	2.250	50	2442500000	
17	60.96	2.400	50	2442440000	
18	64.77	2.550	50	2442450000	
19	68.58	2.700	50	2442470000	
20	72.39	2.850	50	2442510000	

### Additional deratings curves

BCZ 3.81../180 - SCDV-THR 3.81../180

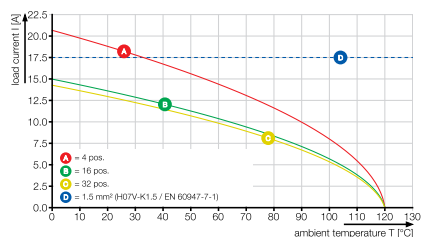

BCZ 3.81../180 - SCDV-THR 3.81../180

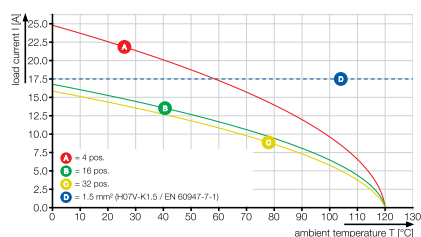

## Connectors in 3.81 mm pitch Series BC/SC 3.81

### BCZ 3.81../180 ZE



Female plug with screw connection and strain relief for the connected wire. Wire outlet 180° (wire is straight on to the direction of plugging).

- Available in closed version, with screw flange (F) and lock and release-lever (LR).

Weidmüller's 3.81 mm pitch (0.15 inch) plug-in connectors are compatible with the layouts of standard connectors and offer space for labelling and coding.

### Product data

IEC: 320 V / 17.5 A / 0.2 - 1.5 mm<sup>2</sup>  
UL: 300 V / 10 A / AWG 28 - 16



For additional articles and information, refer to [catalog.weidmueller.com](http://catalog.weidmueller.com)

#### Note:

- Additional colours on request
- Rated current related to rated cross-section & min. No. of poles.
- Wire end ferrule without plastic collar to DIN 46228/1
- Wire end ferrule with plastic collar to DIN 46228/4
- P on drawing = pitch
- Rated data refer only to the component itself. Clearance and creepage distances to other components are to be designed in accordance with the relevant application standards.

### BCZ 3.81../180ZE

with strain relief



#### Dimensioned drawing

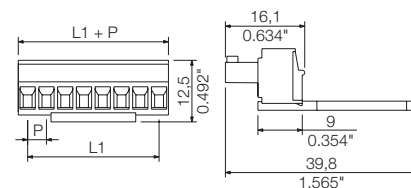

OMNIMATE® Signal  
PCB connectors in 3.81 mm pitch

F

### Technical data

#### In compliance with IEC 60664-1 / IEC 61984

Clamping range, max.	mm <sup>2</sup>	0.08...1.5
<b>Solid core H05(07) V-U</b>	<b>mm<sup>2</sup></b>	<b>0.2...1.5</b>
Stranded H07 V-R		
Flexible H05(07) V-K	mm <sup>2</sup>	0.2...1.5
Flexible with ferrule	mm <sup>2</sup>	0.2...1.5
Ferrule with plastic collar	mm <sup>2</sup>	0.2...1.5
Stripping length	mm	7
Screwdriver blade	mm	0.4 x 2.5
According to norm		DIN 5264
Tightening torque range	Nm	0.2...0.25
<b>Rated current, max.</b>	<b>A</b>	<b>17.5 17</b>
At ambient temperature	20°C	40°C
For conductor cross-section	mm <sup>2</sup>	1
Overtoltage category		III III II
Pollution severity		3 2 2
<b>Rated voltage</b>	<b>V</b>	<b>160 160 320</b>
Rated impulse voltage	kV	2.5 2.5 2.5
<b>UL / CUL (Use Group)</b>	<b>B C D</b>	<b>D</b>

<b>Rated voltage</b>	<b>V</b>	<b>300 300</b>
<b>Rated current</b>	<b>A</b>	<b>10 10</b>
<b>AWG conductor</b>	<b>AWG</b>	<b>28-16</b>
<b>CSA (Use Group)</b>	<b>B C D</b>	<b>D</b>
Rated voltage	V	300 50
Rated current	A	8 8
AWG conductor	AWG	28-16

#### General data

Type of insulation material	PA 66 GF 30
UL 94 flammability rating	V-0
Contact base material	Copper alloy
Material of contact surface	tinned
Pin dimensions = d	mm
Solder eyelet Ø = D	mm
Solder eyelet Ø tolerance	mm

### Accessories

Note: Refer to the Accessories chapter for additional accessories.

Screwdriver		Order No.
	SDS 0.4X2.5X75	9009030000
	SDIS 0.4X2.5X75	9008370000

### Ordering data

Solder pin length				
Colour	Orange			
Pitch	3.81 mm			
Pol.	L1	(inch)	Qty.	Order No.
5	15.24	0.600	50	1236270000
6	19.05	0.750	50	1236280000
7	22.86	0.900	50	1236290000
8	26.67	1.050	50	1236300000
9	30.48	1.200	50	1236320000
10	34.29	1.350	50	1236330000
11	38.10	1.500	50	1236340000
12	41.91	1.650	50	1236370000
13	45.72	1.800	50	1236380000
14	49.53	1.950	50	1236390000
15	53.34	2.100	50	1236400000
16	57.15	2.250	50	1236410000
17	60.96	2.400	50	1236420000
18	64.77	2.550	50	1236430000
19	68.58	2.700	50	1236440000
20	72.39	2.850	50	1236470000

from 10 pole 2 strain reliefs per plug-in connector

### Representative deratings curve

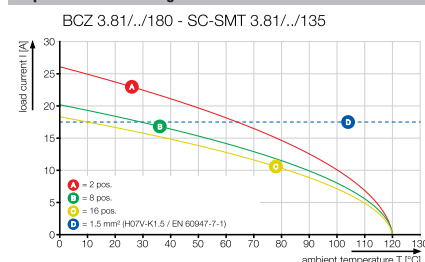

from 10 pole 2 strain reliefs per plug-in connector

### BCZ 3.81../180FZE

with screw flange and strain relief



Dimensioned drawing

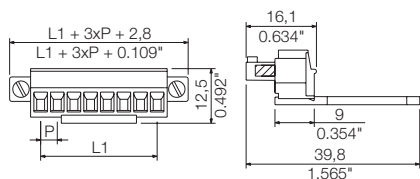

### BCZ 3.81../180LRZE



Dimensioned drawing

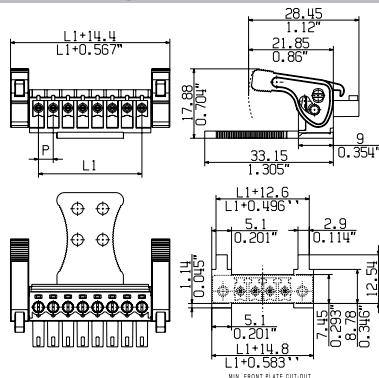

#### Ordering data

Solder pin length					
Colour					Orange
Pitch 3.81 mm					
Pol.	L1	(inch)	Qty.	Order No.	
5	15.24	0.600	50	1236530000	
6	19.05	0.750	50	1236540000	
7	22.86	0.900	50	1236570000	
8	26.67	1.050	50	1236590000	
9	30.48	1.200	50	1236600000	
10	34.29	1.350	50	1236610000	
11	38.10	1.500	50	1236620000	
12	41.91	1.650	50	1236630000	
13	45.72	1.800	50	1236640000	
14	49.53	1.950	50	1236670000	
15	53.34	2.100	50	1236680000	
16	57.15	2.250	50	1236690000	
17	60.96	2.400	50	1236700000	
18	64.77	2.550	50	1236720000	
19	68.58	2.700	50	1236730000	
20	72.39	2.850	50	1236740000	

#### Ordering data

Solder pin length					
Colour					Orange
Pitch 3.81 mm					
Pol.	L1	(inch)	Qty.	Order No.	
5	15.24	0.600	50	2442030000	
6	19.05	0.750	50	2442260000	
7	22.86	0.900	50	2442210000	
8	26.67	1.050	50	2442290000	
9	30.48	1.200	50	2442300000	
10	34.29	1.350	50	2442240000	
11	38.10	1.500	50	2442220000	
12	41.91	1.650	50	2442270000	
13	45.72	1.800	50	2442190000	
14	49.53	1.950	50	2442280000	
15	53.34	2.100	50	2442200000	
16	57.15	2.250	50	2442160000	
17	60.96	2.400	50	2442250000	
18	64.77	2.550	50	2442170000	
19	68.58	2.700	50	2442230000	
20	72.39	2.850	50	2442180000	

from 10 pole 2 strain reliefs per plug-in connector

#### Additional deratings curves

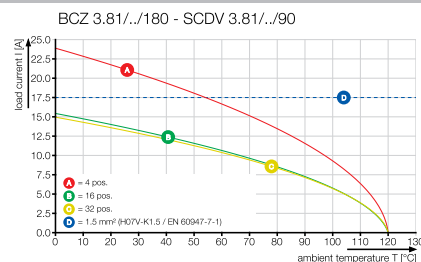
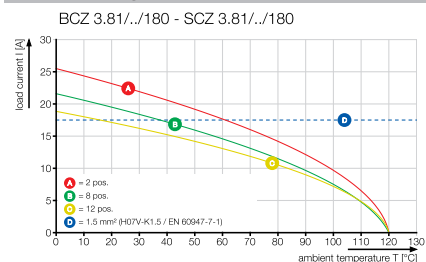

### BCZ 3.81../90 & 270

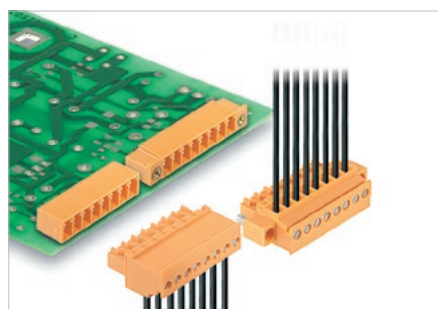

Female plug with screw connection.

Wire outlet direction:

- 90° - wire perpendicular to plugging direction and above
- 270° - wire perpendicular to plugging direction and below
- Available in closed version and with screw flange (F).

Weidmüller's 3.81 mm pitch (0.15 inch) plug-in connectors are compatible with the layouts of standard connectors and offer space for labelling and coding.

### Product data

IEC: 320 V / 17.5 A / 0.2 - 1.5 mm<sup>2</sup>  
UL: 300 V / 10 A / AWG 28 - 16



For additional articles and information, refer to [catalog.weidmuller.com](http://catalog.weidmuller.com)

#### Note:

- Additional colours on request
- Rated current related to rated cross-section & min. No. of poles.
- Wire end ferrule without plastic collar to DIN 46228/1
- Wire end ferrule with plastic collar to DIN 46228/4
- P on drawing = pitch
- Rated data refer only to the component itself. Clearance and creepage distances to other components are to be designed in accordance with the relevant application standards.

### BCZ 3.81../90



#### Dimensioned drawing

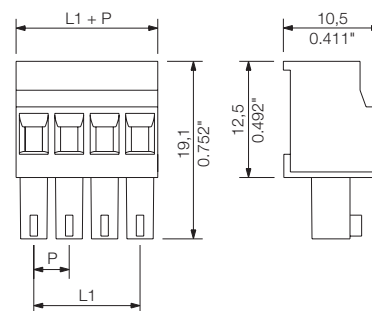

### Technical data

#### In compliance with IEC 60664-1 / IEC 61984

Clamping range, max.	mm <sup>2</sup>	0.08...1.5
<b>Solid core H05(07) V-U</b>	<b>mm<sup>2</sup></b>	<b>0.2...1.5</b>
Stranded H07 V-R		
Flexible H05(07) V-K	mm <sup>2</sup>	0.2...1.5
Flexible with ferrule	mm <sup>2</sup>	0.2...1.5
Ferrule with plastic collar	mm <sup>2</sup>	0.2...1.5
Stripping length	mm	7
Screwdriver blade	mm	0.4 x 2.5
According to norm		DIN 5264
Tightening torque range	Nm	0.2...0.25
<b>Rated current, max.</b>	<b>A</b>	<b>17.5 17.5</b>
At ambient temperature	20°C	40°C
For conductor cross-section	mm <sup>2</sup>	1
Overtoltage category		III III II
Pollution severity		3 2 2
<b>Rated voltage</b>	<b>V</b>	<b>160 160 320</b>
Rated impulse voltage	kV	2.5 2.5 2.5
<b>UL / CUL (Use Group)</b>	<b>B C D</b>	<b>D</b>
<b>Rated voltage</b>	<b>V</b>	<b>300 300</b>
<b>Rated current</b>	<b>A</b>	<b>10 10</b>
<b>AWG conductor</b>	<b>AWG</b>	<b>28-16</b>
<b>CSA (Use Group)</b>	<b>B C D</b>	<b>D</b>
Rated voltage	V	300 50
Rated current	A	8 8
AWG conductor	AWG	28-16
<b>General data</b>		
Type of insulation material		PA 66 GF 30
UL 94 flammability rating		V-0
Contact base material		Copper alloy
Material of contact surface		tinned
Pin dimensions = d	mm	
Solder eyelet Ø = D	mm	
Solder eyelet Ø tolerance	mm	

### Accessories

Note: Refer to the Accessories chapter for additional accessories.

Screwdriver		Order No.
	SDS 0.4X2.5X75	<b>9009030000</b>
	SDIS 0.4X2.5X75	<b>9008370000</b>

### Ordering data

Solder pin length				
Colour	Orange			
Pitch	3.81 mm			
Pol.	L1	(inch)	Qty.	Order No.
2	3.81	0.150	50	<b>1939820000</b>
3	7.62	0.300	50	<b>1939830000</b>
4	11.43	0.450	50	<b>1939840000</b>
5	15.24	0.600	50	<b>1939860000</b>
6	19.05	0.750	50	<b>1939870000</b>
7	22.86	0.900	50	<b>1939880000</b>
8	26.67	1.050	50	<b>1939890000</b>
9	30.48	1.200	50	<b>1939900000</b>
10	34.29	1.350	50	<b>1939910000</b>
11	38.10	1.500	50	<b>1939920000</b>
12	41.91	1.650	50	<b>1939930000</b>
13	45.72	1.800	50	<b>1939940000</b>
14	49.53	1.950	50	<b>1939950000</b>
15	53.34	2.100	50	<b>1939960000</b>
16	57.15	2.250	50	<b>1939970000</b>

### Representative deratings curve

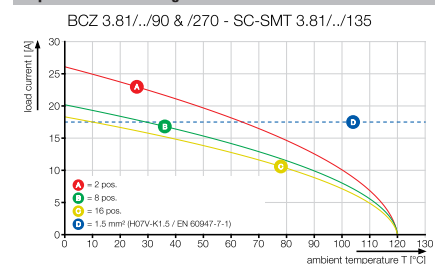

### BCZ 3.81../90F

with screw flange



Dimensioned drawing

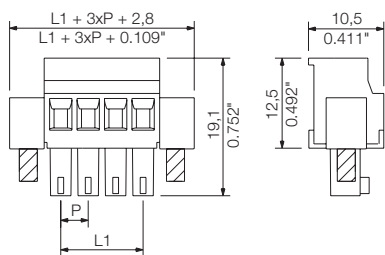

#### Ordering data

Solder pin length					
Colour					Orange
Pitch 3.81 mm					
Pol.	L1	(inch)	Qty.	Order No.	
2	3.81	0.150	50	1939980000	
3	7.62	0.300	50	1939990000	
4	11.43	0.450	50	1940000000	
5	15.24	0.600	50	1940010000	
6	19.05	0.750	50	1940020000	
7	22.86	0.900	50	1940030000	
8	26.67	1.050	50	1940040000	
9	30.48	1.200	50	1940050000	
10	34.29	1.350	50	1940060000	
11	38.10	1.500	50	1940070000	
12	41.91	1.650	50	1940080000	
13	45.72	1.800	50	1940090000	
14	49.53	1.950	50	1940100000	
15	53.34	2.100	50	1940110000	
16	57.15	2.250	50	1940120000	

### BCZ 3.81../270

with screw flange



Dimensioned drawing

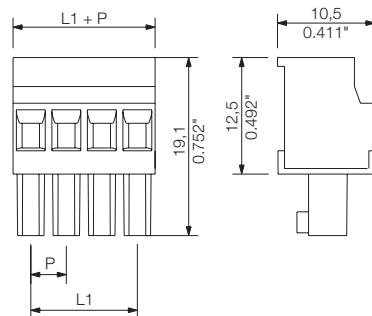

#### Ordering data

Solder pin length					
Colour					Orange
Pitch 3.81 mm					
Pol.	L1	(inch)	Qty.	Order No.	
2	3.81	0.150	50	1940190000	
3	7.62	0.300	50	1940200000	
4	11.43	0.450	50	1940210000	
5	15.24	0.600	50	1940220000	
6	19.05	0.750	50	1940230000	
7	22.86	0.900	50	1940240000	
8	26.67	1.050	50	1940250000	
9	30.48	1.200	50	1940260000	
10	34.29	1.350	50	1940270000	
11	38.10	1.500	50	1940280000	
12	41.91	1.650	50	1940290000	
13	45.72	1.800	50	1940300000	
14	49.53	1.950	50	1940310000	
15	53.34	2.100	50	1940320000	
16	57.15	2.250	50	1940330000	

### BCZ 3.81../270F

with screw flange



Dimensioned drawing

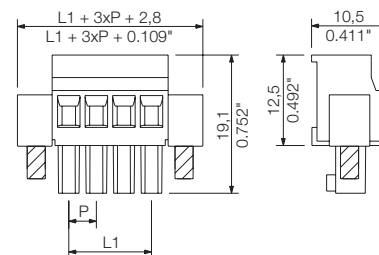

#### Ordering data

Solder pin length					
Colour					Orange
Pitch 3.81 mm					
Pol.	L1	(inch)	Qty.	Order No.	
2	3.81	0.150	50	1940460000	
3	7.62	0.300	50	1940470000	
4	11.43	0.450	50	1940480000	
5	15.24	0.600	50	1940490000	
6	19.05	0.750	50	1940500000	
7	22.86	0.900	50	1940510000	
8	26.67	1.050	50	1940520000	
9	30.48	1.200	50	1940530000	
10	34.29	1.350	50	1940540000	
11	38.10	1.500	50	1940550000	
12	41.91	1.650	50	1940560000	
13	45.72	1.800	50	1940570000	
14	49.53	1.950	50	1940580000	
15	53.34	2.100	50	1940590000	
16	57.15	2.250	50	1940600000	

#### Additional deratings curves

BCZ 3.81../90 & /270 - SC 3.81../135

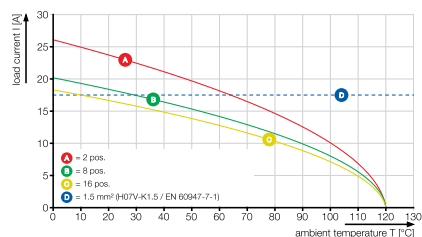

BCF 3.81/./180

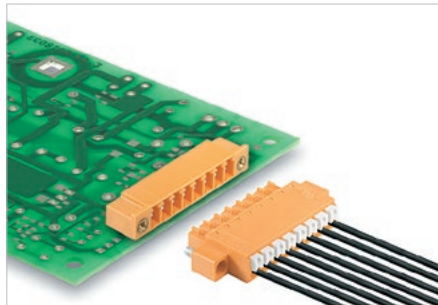

Female plug with "PUSH IN" wire connection.

- Simply insert the wire and it's ready.
- Integrated push-button for opening the terminal point
- High component density because of very low height, especially when combined with the compact double-level SCDN / SCDN-THR male header.
- Available in closed version, with screw flange (F) and lock a release-lever (LR).

Weidmüller's 3.81 mm pitch (0.15 inch) plug-in connectors are compatible with the layouts of standard connectors and offer space for labelling and coding.

Product data

IEC: 320 V / 17.5 A / 0.14 - 1.5 mm<sup>2</sup>  
UL: 300 V / 10 A / AWG 26 - 16



For additional articles and information, refer to [catalog.weidmueller.com](http://catalog.weidmueller.com)

Note:

- Additional colours on request
- Crimp shape A for wire-end ferrules with crimping tools PZ 1,5 (order no. 9005990000) or PZ 6/5 (order no. 9011460000) for larger wire cross-sections recommended.
- Rated current related to rated cross-section & min. No. of poles.
- Wire end ferrule without plastic collar to DIN 46228/1
- Wire end ferrule with plastic collar to DIN 46228/4
- P on drawing = pitch
- Rated data refer only to the component itself. Clearance and creepage distances to other components are to be designed in accordance with the relevant application standards.
- Conductors suitable for connection: 1.5 mm<sup>2</sup> with wire-end ferrule with plastic collar, DIN 46 228/1, with a rated voltage of 125V/2.5 kV with III/3 or 250 V/2.5 kV with II/2

BCF 3.81/./180



Dimensioned drawing

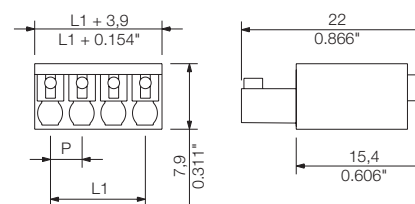

Technical data

In compliance with IEC 60664-1 / IEC 61984

Clamping range, max.	mm <sup>2</sup>	0.14...1.5
<b>Solid core H05(07) V-U</b>	<b>mm<sup>2</sup></b>	<b>0.14...1.5</b>
Stranded H07 V-R		
Flexible H05(07) V-K	mm <sup>2</sup>	0.14...1.5
Flexible with ferrule	mm <sup>2</sup>	0.25...1.5
Ferrule with plastic collar	mm <sup>2</sup>	0.25...1
Stripping length	mm	9
Screwdriver blade	mm	0.4 x 2.5
According to norm		DIN 5264
Tightening torque range		
<b>Rated current, max.</b>	<b>A</b>	<b>17.5 17.5</b>
At ambient temperature	20°C	40°C
For conductor cross-section	mm <sup>2</sup>	1
Overvoltage category		III III II
Pollution severity		3 2 2
<b>Rated voltage</b>	<b>V</b>	<b>160 160 320</b>
Rated impulse voltage	kV	2.5 2.5 2.5
<b>UL / CUL (Use Group)</b>	<b>B C D</b>	<b>D</b>
<b>Rated voltage</b>	<b>V</b>	<b>300 300</b>
<b>Rated current</b>	<b>A</b>	<b>10 10</b>
<b>AWG conductor</b>	<b>AWG</b>	<b>26-16</b>
<b>CSA (Use Group)</b>	<b>B C D</b>	<b>D</b>
Rated voltage	V	300 50 300
Rated current	A	11 11 11
AWG conductor	AWG	26-16
<b>General data</b>		
Type of insulation material		PA 66 GF 30
UL 94 flammability rating		V-0
Contact base material		Copper alloy
Material of contact surface		tinned
Pin dimensions = d	mm	
Solder eyelet Ø = D	mm	
Solder eyelet Ø tolerance	mm	

Accessories

Note: Refer to the Accessories chapter for additional accessories.

Screwdriver		Order No.
	SDS 0.4X2.5X75	9009030000
	SDIS 0.4X2.5X75	9008370000
Crimping tool		
	PZ 6/5	9011460000
	PZ 1.5	9005990000

Ordering data

Solder pin length		Orange		
Colour				
Pitch	3.81 mm			
Pol.	L1	(inch)	Qty.	Order No.
2	3.81	0.150	50	1969090000
3	7.62	0.300	50	1969100000
4	11.43	0.450	50	1969110000
5	15.24	0.600	50	1969120000
6	19.05	0.750	50	1969130000
7	22.86	0.900	50	1969140000
8	26.67	1.050	50	1969150000
9	30.48	1.200	50	1969160000
10	34.29	1.350	50	1969170000
11	38.10	1.500	50	1969180000
12	41.91	1.650	50	1969190000
13	45.72	1.800	50	1969200000
14	49.53	1.950	50	1969210000
15	53.34	2.100	50	1969220000
16	57.15	2.250	50	1969230000
17	60.96	2.400	50	1969240000
18	64.77	2.550	50	1969250000

Representative deratings curve

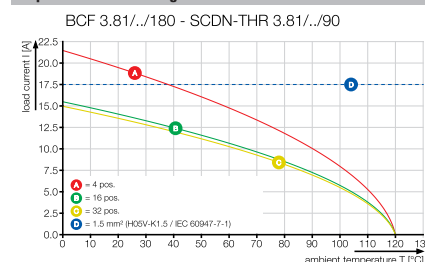

### BCF 3.81../180F

with screw flange

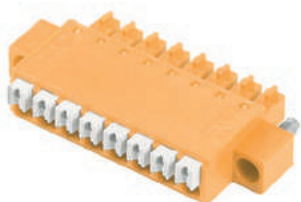

Dimensioned drawing

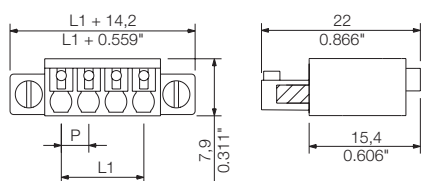

### Ordering data

Solder pin length					
Colour					Orange
Pitch 3.81 mm					
Pol.	L1	(inch)	Qty.	Order No.	
2	3.81	0.150	50	1970300000	
3	7.62	0.300	50	1970330000	
4	11.43	0.450	50	1970370000	
5	15.24	0.600	50	1970380000	
6	19.05	0.750	50	1970400000	
7	22.86	0.900	50	1970440000	
8	26.67	1.050	50	1970550000	
9	30.48	1.200	50	1970570000	
10	34.29	1.350	50	1970580000	
11	38.10	1.500	50	1970620000	
12	41.91	1.650	50	1970650000	
13	45.72	1.800	50	1970690000	
14	49.53	1.950	50	1970730000	
15	53.34	2.100	50	1970750000	
16	57.15	2.250	50	1970820000	
17	60.96	2.400	50	1970850000	
18	64.77	2.550	50	1970890000	

### BCF 3.81../180LR



Dimensioned drawing

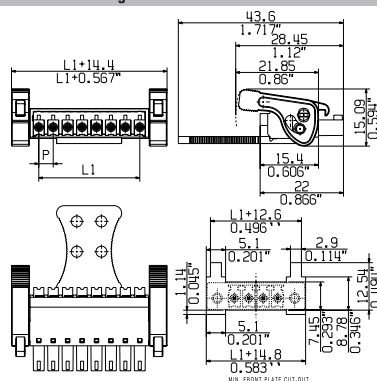

### Ordering data

Solder pin length					
Colour					Orange
Pitch 3.81 mm					
Pol.	L1	(inch)	Qty.	Order No.	
2	3.81	0.150	50	2442040000	
3	7.62	0.300	50	2442610000	
4	11.43	0.450	50	2442620000	
5	15.24	0.600	50	2442630000	
6	19.05	0.750	50	2442640000	
7	22.86	0.900	50	2442650000	
8	26.67	1.050	50	2442660000	
9	30.48	1.200	50	2442670000	
10	34.29	1.350	50	2442680000	
11	38.10	1.500	50	2442690000	
12	41.91	1.650	50	2442700000	
13	45.72	1.800	50	2442710000	
14	49.53	1.950	50	2442720000	
15	53.34	2.100	50	2442730000	
16	57.15	2.250	50	2442740000	
17	60.96	2.400	50	2442750000	
18	64.77	2.550	50	2442760000	

### Additional deratings curves

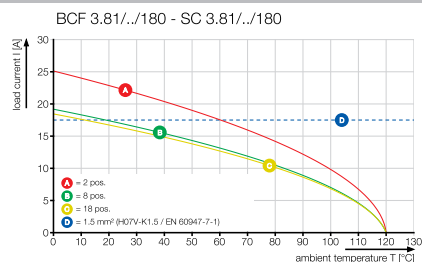
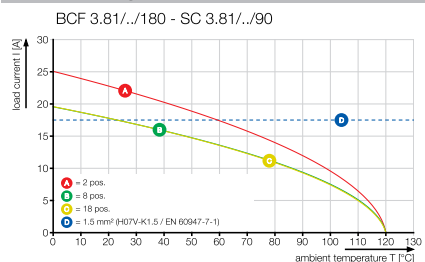

BCF 3.81../180 ZE

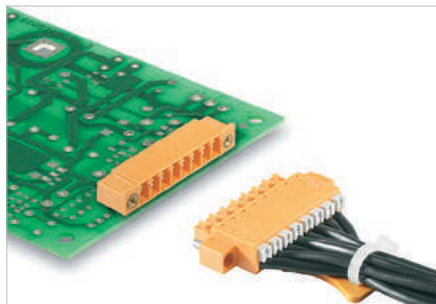

Female plug with strain relief (ZE) for the connected wire.

- PUSH IN wire connection method
- Simply insert the prepared wire and attach the strain relief mechanism
- Intuitive handling - since the wire-entry area and handling area are clearly separated.

Weidmüller's 3.81 mm pitch (0.15 inch) plug-in connectors are compatible with the layouts of standard connectors and offer space for labelling and coding.

Product data

IEC: 320 V / 17.5 A / 0.14 - 1.5 mm<sup>2</sup>  
UL: 300 V / 10 A / AWG 26 - 16



For additional articles and information, refer to [catalog.weidmueller.com](http://catalog.weidmueller.com)

Note:

- Additional colours on request
- Crimp shape A for wire-end ferrules with crimping tools PZ 1,5 (order no. 9005990000) or PZ 6/5 (order no. 9011460000) for larger wire cross-sections recommended.
- Rated current related to rated cross-section & min. No. of poles.
- Wire end ferrule without plastic collar to DIN 46228/1
- Wire end ferrule with plastic collar to DIN 46228/4
- P on drawing = pitch
- Rated data refer only to the component itself. Clearance and creepage distances to other components are to be designed in accordance with the relevant application standards.
- Conductors suitable for connection: 1.5 mm<sup>2</sup> with wire-end ferrule with plastic collar, DIN 46 228/1, with a rated voltage of 125V/2.5 kV with III/3 or 250 V/2.5 kV with II/2

BCF 3.81../180ZE

with strain relief



Dimensioned drawing

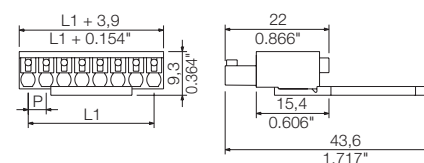

Technical data

In compliance with IEC 60664-1 / IEC 61984			
Clamping range, max.	mm <sup>2</sup>	0.14...1.5	
<b>Solid core H05(07) V-U</b>	<b>mm<sup>2</sup></b>	<b>0.14...1.5</b>	
Stranded H07 V-R			
Flexible H05(07) V-K	mm <sup>2</sup>	0.14...1.5	
Flexible with ferrule	mm <sup>2</sup>	0.25...1.5	
Ferrule with plastic collar	mm <sup>2</sup>	0.25...1	
Stripping length	mm	9	
Screwdriver blade	mm	0.4 x 2.5	
According to norm			
Tightening torque range			
<b>Rated current, max.</b>	<b>A</b>	<b>17.5</b>	<b>17.5</b>
At ambient temperature	20°C	40°C	
For conductor cross-section	mm <sup>2</sup>	1	
Overtension category		III	III II
Pollution severity		3	2 2
<b>Rated voltage</b>	<b>V</b>	<b>160</b>	<b>160 320</b>
Rated impulse voltage	kV	2.5	2.5 2.5
<b>UL / CUL (Use Group)</b>		<b>B</b>	<b>C D</b>
<b>Rated voltage</b>	<b>V</b>	<b>300</b>	<b>300</b>
<b>Rated current</b>	<b>A</b>	<b>10</b>	<b>10</b>
<b>AWG conductor</b>	<b>AWG</b>	<b>26-16</b>	
<b>CSA (Use Group)</b>		<b>B</b>	<b>C D</b>
Rated voltage	V	300	50 300
Rated current	A	11	11 11
AWG conductor	AWG	26-16	
General data			
Type of insulation material		PA 66 GF 30	
UL 94 flammability rating		V-0	
Contact base material		Copper alloy	
Material of contact surface		tinned	
Pin dimensions = d	mm		
Solder eyelet Ø = D	mm		
Solder eyelet Ø tolerance	mm		

Accessories

Note: Refer to the Accessories chapter for additional accessories.

Screwdriver		Order No.
	SDS 0.4X2.5X75	<b>9009030000</b>
	SDIS 0.4X2.5X75	<b>9008370000</b>
Crimping tool		
	PZ 6/5	<b>9011460000</b>
	PZ 1.5	<b>9005990000</b>

Ordering data

Solder pin length					
Colour	Orange				
Pitch	3.81 mm				
Pol.	L1	(inch)	Qty.	Order No.	
5	15.24	0.600	50	<b>1235790000</b>	
6	19.05	0.750	50	<b>1235800000</b>	
7	22.86	0.900	50	<b>1235810000</b>	
8	26.67	1.050	50	<b>1235820000</b>	
9	30.48	1.200	50	<b>1235830000</b>	
10	34.29	1.350	50	<b>1235840000</b>	
11	38.10	1.500	50	<b>1235870000</b>	
12	41.91	1.650	50	<b>1235880000</b>	
13	45.72	1.800	50	<b>1235890000</b>	
14	49.53	1.950	50	<b>1235900000</b>	
15	53.34	2.100	50	<b>1235910000</b>	
16	57.15	2.250	50	<b>1235920000</b>	
17	60.96	2.400	50	<b>1235930000</b>	
18	64.77	2.550	50	<b>1235940000</b>	

from 10 pole 2 strain reliefs per plug-in connector

Representative deratings curve

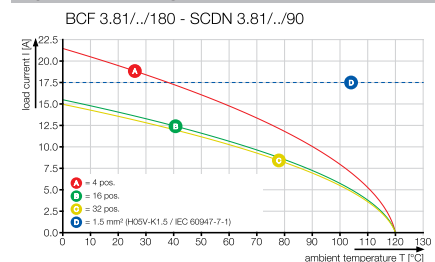

from 10 pole 2 strain reliefs per plug-in connector



### BCF 3.81../180FZE

with screw flange and strain relief



Dimensioned drawing

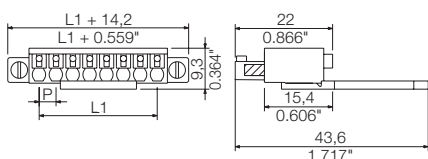

### BCF 3.81../180LRZE



Dimensioned drawing

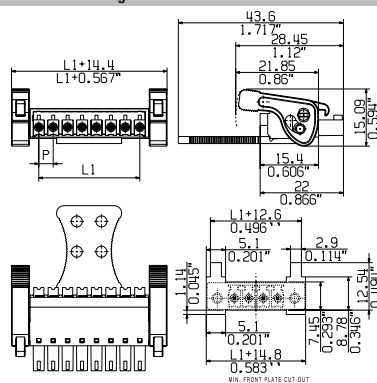

### Ordering data

Solder pin length					
Colour					Orange
Pitch 3.81 mm					
Pol.	L1	(inch)	Qty.	Order No.	
5	15.24	0.600	50	1235970000	
6	19.05	0.750	50	1235980000	
7	22.86	0.900	50	1235990000	
8	26.67	1.050	50	1236000000	
9	30.48	1.200	50	1236010000	
10	34.29	1.350	50	1236020000	
11	38.10	1.500	50	1236030000	
12	41.91	1.650	50	1236040000	
13	45.72	1.800	50	1236050000	
14	49.53	1.950	50	1236070000	
15	53.34	2.100	50	1236080000	
16	57.15	2.250	50	1236090000	
17	60.96	2.400	50	1236100000	
18	64.77	2.550	50	1236110000	

### Ordering data

Solder pin length					
Colour					Orange
Pitch 3.81 mm					
Pol.	L1	(inch)	Qty.	Order No.	
5	15.24	0.600	50	2442960000	
6	19.05	0.750	50	2443010000	
7	22.86	0.900	50	2443060000	
8	26.67	1.050	50	2443020000	
9	30.48	1.200	50	2443030000	
10	34.29	1.350	50	2442910000	
11	38.10	1.500	50	2442920000	
12	41.91	1.650	50	2443050000	
13	45.72	1.800	50	2442930000	
14	49.53	1.950	50	2442990000	
15	53.34	2.100	50	2442980000	
16	57.15	2.250	50	2442940000	
17	60.96	2.400	50	2442970000	
18	64.77	2.550	50	2442950000	

from 10 pole 2 strain reliefs per plug-in connector

### Additional deratings curves

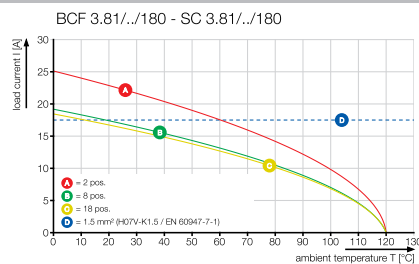
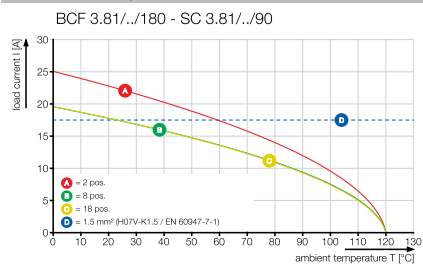

## Connectors in 3.81 mm pitch Series BC/SC 3.81

### BCL-SMT 3.81/./90

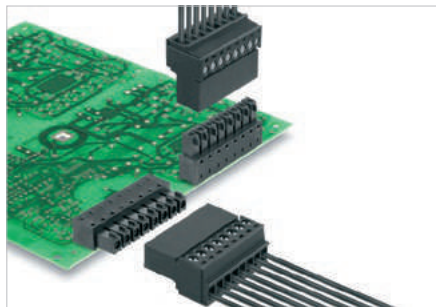

Inverted female headers for:

- Touch-safety on the circuit board with board-to-wire connection (with the SCZ)
- Board-to-board component connection (with SC/SC-SMT)
- Works with reflow soldering and automatic placement.
- Orientation: 90°
- Available in closed version with screw Flange (F) and inverted solder flange (LFI).

Weidmüller's 3.81 mm pitch (0.15 inch) plug-in connectors are compatible with the layouts of standard connectors and offer space for labelling and coding.

### Product data

IEC: 320 V / 17.5 A  
UL: 300 V / 10 A



For additional articles and information, refer to [catalog.weidmueller.com](http://catalog.weidmueller.com)

#### Note:

- Rated current related to rated cross-section & min. No. of poles.
- P on drawing = pitch
- Rated data refer only to the component itself. Clearance and creepage distances to other components are to be designed in accordance with the relevant application standards.

### BCL-SMT 3.81/./90



#### Dimensioned drawing

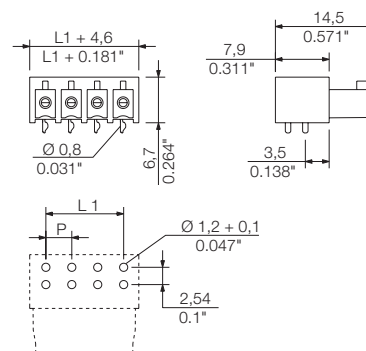

### Technical data

#### In compliance with IEC 60664-1 / IEC 61984

Clamping range, max.			
<b>Solid core H05(07) V-U</b>			
Stranded H07 V-R			
Flexible H05(07) V-K			
Flexible with ferrule			
Ferrule with plastic collar			
Stripping length			
Screwdriver blade	mm		
According to norm			
Tightening torque range			
<b>Rated current, max.</b>	<b>A</b>	<b>17.5</b>	<b>17.5</b>
At ambient temperature		20°C	40°C
For conductor cross-section			
Overtoltage category		III	III II
Pollution severity		3	2 2
<b>Rated voltage</b>	<b>V</b>	<b>160</b>	<b>160 320</b>
Rated impulse voltage	kV	2.5	2.5 2.5
<b>UL / CUL (Use Group)</b>		<b>B</b>	<b>C D</b>
<b>Rated voltage</b>	<b>V</b>	<b>300</b>	<b>300</b>
<b>Rated current</b>	<b>A</b>	<b>10</b>	<b>10</b>
<b>AWG conductor</b>	<b>AWG</b>		-
<b>CSA (Use Group)</b>		<b>B</b>	<b>C D</b>
Rated voltage	V	300	50
Rated current	A	11	11
AWG conductor	AWG		-
<b>General data</b>			
Type of insulation material		LCP GF	
UL 94 flammability rating		V-0	
Contact base material		Copper alloy	
Material of contact surface		tinned	
Pin dimensions = d	mm	0.8	
Solder eyelet Ø = D	mm	1.2	
Solder eyelet Ø tolerance	mm	+ 0,1	

### Accessories

Note: Refer to the Accessories chapter for additional accessories.

### Ordering data

<b>Solder pin length</b>		<b>1.5 mm</b>		
<b>Colour</b>		<b>Black</b>		
<b>Pitch</b>		<b>3.81 mm</b>		
Pol.	L1	(inch)	Qty.	Order No.
2	3.81	0.150	50	1974750000
3	7.62	0.300	50	1974770000
4	11.43	0.450	50	1974780000
5	15.24	0.600	50	1974800000
6	19.05	0.750	50	1974820000
7	22.86	0.900	50	1974840000
8	26.67	1.050	50	1974850000
9	30.48	1.200	50	1974880000
10	34.29	1.350	50	1974890000
11	38.10	1.500	50	1974910000
12	41.91	1.650	50	1974930000

### Representative deratings curve

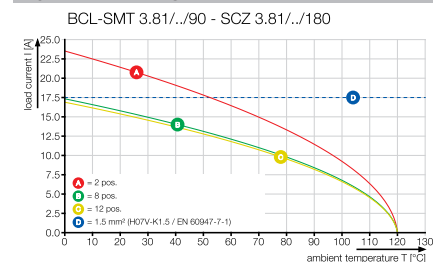

**BCL-SMT 3.81/./90LF1**

with inverted solder flange



Dimensioned drawing

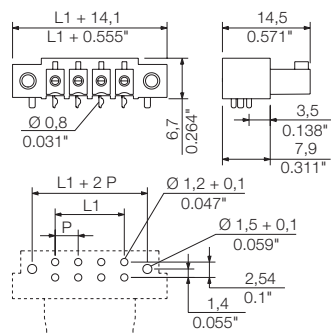

**Ordering data**

Solder pin length		1.5 mm	
Colour		Black	
Pitch		3.81 mm	
Pol.	L1	(inch)	Qty. Order No.
2	3.81	0.150	50 1028720000
3	7.62	0.300	50 1028730000
4	11.43	0.450	50 1028740000
5	15.24	0.600	50 1028750000
6	19.05	0.750	50 1028760000
7	22.86	0.900	50 1028770000
8	26.67	1.050	50 1028790000
9	30.48	1.200	50 1028810000
10	34.29	1.350	50 1028820000
11	38.10	1.500	50 1028830000
12	41.91	1.650	50 1028840000

**BCL-SMT 3.81/./90F**

with screw flange



Dimensioned drawing

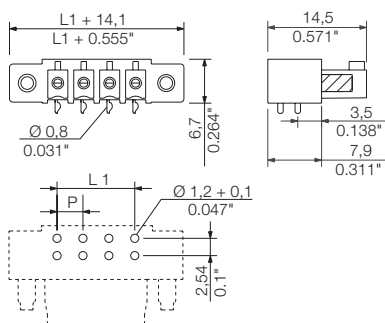

**Ordering data**

Solder pin length		1.5 mm	
Colour		Black	
Pitch		3.81 mm	
Pol.	L1	(inch)	Qty. Order No.
2	3.81	0.150	50 1975690000
3	7.62	0.300	50 1975700000
4	11.43	0.450	50 1975710000
5	15.24	0.600	50 1975730000
6	19.05	0.750	50 1975740000
7	22.86	0.900	50 1975750000
8	26.67	1.050	50 1975760000
9	30.48	1.200	50 1975780000
10	34.29	1.350	50 1975790000
11	38.10	1.500	50 1975820000
12	41.91	1.650	50 1975830000

## Connectors in 3.81 mm pitch Series BC/SC 3.81

### BCL-SMT 3.81../180

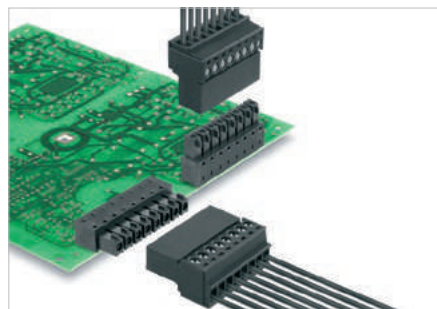

Inverted female headers for:

- Touch-safety on the circuit board with board-to-wire (when connecting with the SCZ)
- Board-to-board component connection (with SC/SC-SMT)
- Works with reflow soldering and automatic placement.
- Orientation: 180°
- Available in closed version and with inverted solder flange (LFI).

Weidmüller's 3.81 mm pitch (0.15 inch) plug-in connectors are compatible with the layouts of standard connectors and offer space for labelling and coding.

### Product data

IEC: 320 V / 17.5 A  
UL: 300 V / 10 A



For additional articles and information, refer to [catalog.weidmueller.com](http://catalog.weidmueller.com)

#### Note:

- Rated current related to rated cross-section & min. No. of poles.
- P on drawing = pitch
- Rated data refer only to the component itself. Clearance and creepage distances to other components are to be designed in accordance with the relevant application standards.

### BCL-SMT 3.81../180



#### Dimensioned drawing

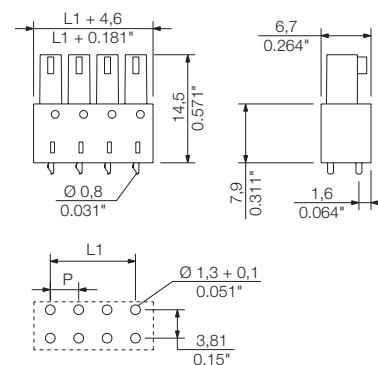

### Technical data

#### In compliance with IEC 60664-1 / IEC 61984

Clamping range, max.			
<b>Solid core H05(07) V-U</b>			
Stranded H07 V-R			
Flexible H05(07) V-K			
Flexible with ferrule			
Ferrule with plastic collar			
Stripping length			
Screwdriver blade	mm		
According to norm			
Tightening torque range			
<b>Rated current, max.</b>	<b>A</b>	<b>17.5</b>	<b>17.5</b>
At ambient temperature		20°C	40°C
For conductor cross-section			
Overtolerance category		III	III II
Pollution severity		3	2 2
<b>Rated voltage</b>	<b>V</b>	<b>160</b>	<b>160 320</b>
Rated impulse voltage	kV	2.5	2.5 2.5
<b>UL / CUL (Use Group)</b>		<b>B</b>	<b>C D</b>
<b>Rated voltage</b>	<b>V</b>	<b>300</b>	<b>300</b>
<b>Rated current</b>	<b>A</b>	<b>10</b>	<b>10</b>
<b>AWG conductor</b>	<b>AWG</b>		-
<b>CSA (Use Group)</b>		<b>B</b>	<b>C D</b>
Rated voltage	V	300	50
Rated current	A	11	11
AWG conductor	AWG		-
<b>General data</b>			
Type of insulation material		LCP GF	
UL 94 flammability rating		V-0	
Contact base material		Copper alloy	
Material of contact surface		tinned	
Pin dimensions = d	mm	0.8	
Solder eyelet Ø = D	mm	1.2	
Solder eyelet Ø tolerance	mm	+ 0,1	

### Accessories

Note: Refer to the Accessories chapter for additional accessories.

### Ordering data

<b>Solder pin length</b>		<b>1.5 mm</b>		
<b>Colour</b>		<b>Black</b>		
<b>Pitch</b>		<b>3.81 mm</b>		
Pol.	L1	(inch)	Qty.	Order No.
2	3.81	0.150	50	1976490000
3	7.62	0.300	50	1976500000
4	11.43	0.450	50	1976520000
5	15.24	0.600	50	1976530000
6	19.05	0.750	50	1976550000
7	22.86	0.900	50	1976570000
8	26.67	1.050	50	1976580000
9	30.48	1.200	50	1976590000
10	34.29	1.350	50	1976610000
11	38.10	1.500	50	1976620000
12	41.91	1.650	50	1976640000

### Representative deratings curve

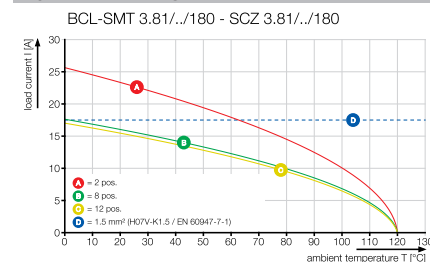

**BCL-SMT 3.81/./180LFI**

with inverted solder flange



Dimensioned drawing

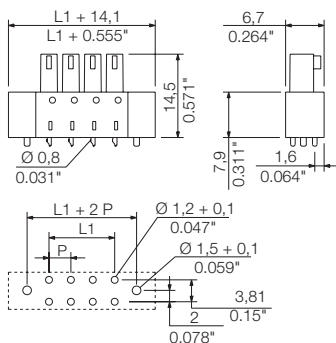

**Ordering data**

Solder pin length		1.5 mm		
Colour		Black		
Pitch		3.81 mm		
Pol.	L1	(inch)	Qty.	Order No.
2	3.81	0.150	50	1029260000
3	7.62	0.300	50	1029270000
4	11.43	0.450	50	1029280000
5	15.24	0.600	50	1029290000
6	19.05	0.750	50	1029310000
7	22.86	0.900	50	1029320000
8	26.67	1.050	50	1029330000
9	30.48	1.200	50	1029340000
10	34.29	1.350	50	1029350000
11	38.10	1.500	50	1029360000
12	41.91	1.650	50	1029370000



# OMNIMATE® Signal PCB connectors in 5.00 mm and 5.08 mm pitch

OMNIMATE® Signal  
PCB connectors in 5.00 mm and 5.08 mm pitch

**OMNIMATE® Signal**  
**PCB connectors in 5.00 mm and 5.08 mm pitch**

Connectors in 5.00 mm pitch and 5.08 mm pitch

Explanation	G.2
Quick selection 5.00 mm	G.14
Quick selection 5.08 mm	G.16
Product selection 5.00 mm	G.22
Product selection 5.08 mm	G.50

**G**

# Male header SL-SMT 5.0x HC and SL-SMarT 5.0x HC

## The connecting element in the reflow process

### Optimised for SMT (Surface Mount Technology)

Innovative, application oriented male headers made from high temperature insulating material LCP (Liquid crystal polymer) permits seamless integration of the connections into the automated SMT production process, including reflow soldering. HC represents additional performance.

The comprehensive portfolio impresses with significant gains in efficiency in assembly production, i.e. a reduction of manufacturing costs of up to 30 %, with increased process security and proven reliability.

### Absolute process reliability

Using glass-fibre reinforced plastic with the SL 5.08 HC and SL-SMT 5.08 pin headers ensures a high level of dimensional stability and prevents what is known as the "banana effect" – the printed-circuit board sagging – in the soldering process.

G

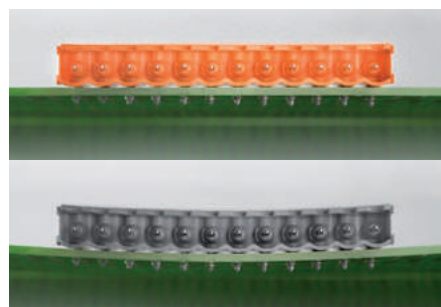

### Standard-compliant fixing

More use with less effort: the soldering flange reduces 3 steps to one while protecting the soldering points from regular mechanical stress. A uniform drill hole diameter, no fixing of the fastening screw – additional fastening takes place automatically in the soldering process.



### SL-SMarT: designed for automatic machine assembly

All pole numbers on board – only 2 articles on the bearing/in the feeder. The strategy of self-adjusting 2- and 3-pole pin header modules not only reduces the variety, but also the costs. The fact that it can be processed without a pick & place pad boosts process reliability and efficiency even more.





**Delivered to fit your process:**

Tape packaging with optimised tape pockets customised to match the width and pole count: this ensures that the feeders are used optimally and that the male headers are securely positioned on the tape.



OMNIMATE® Signal  
PCB connectors in 5.00 mm and 5.08 mm pitch

G

**Specified to fit your application:**

1.5 mm short pins for flush solder joints permit PCB assembly on both sides in accordance with IPC A-610 and also reduces the solder paste volume significantly. At the same time, the required stroke length of the Pick & Place machine is reduced to a minimum. As an alternative, 3.2 mm pins are available for PCBs thicker than 1.6 mm.



## Male header SL 5.00 / SL 5.08 HC

### Optimised for wave soldering

These male headers in 5.00 mm and 5.08 mm pitch with the characteristic wave design in the mating face are the standard headers used in industrial automation. This male header has already enjoyed decades of market success; it is the basis for device connection systems for both wave and manual soldering. HC represents additional performance.

## G

#### Increased density for device connections:

You can maximise connection density by using double level male headers together with your choice of connection systems on the field side.

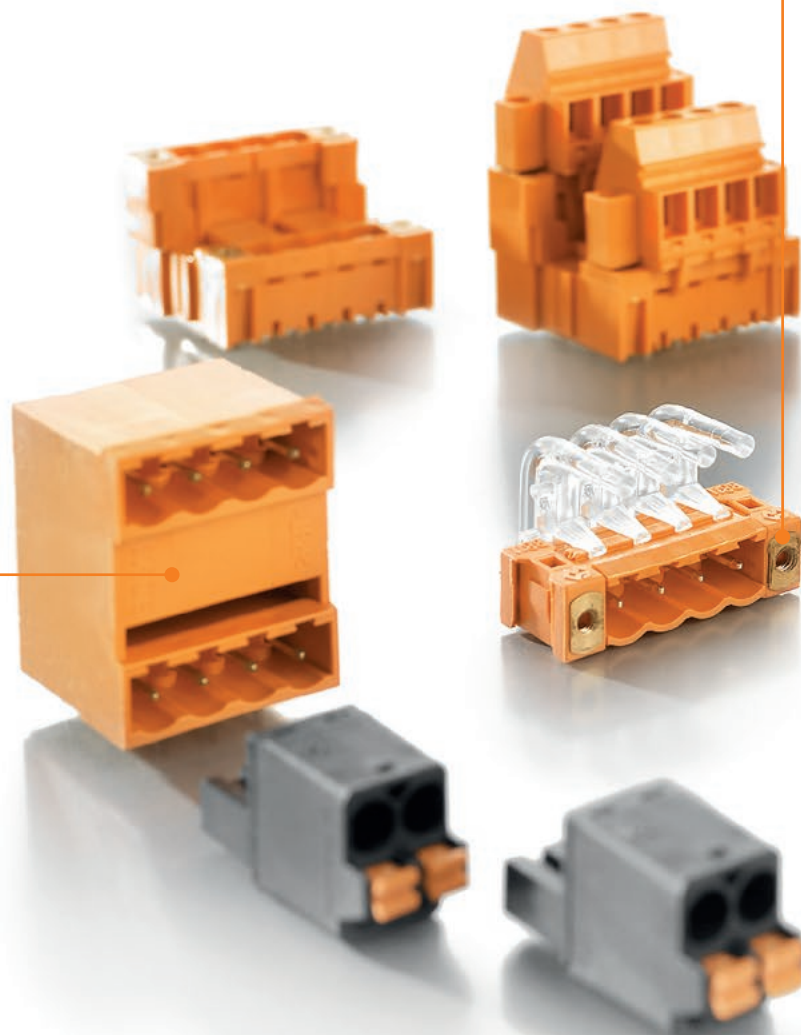
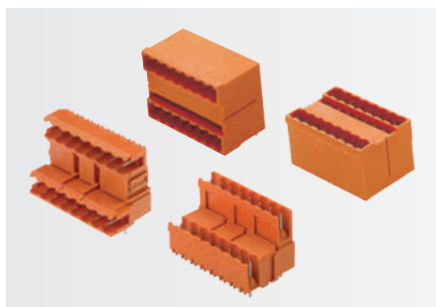

#### Three outlet directions:

There are more device design possibilities created by the different conductor path angles.

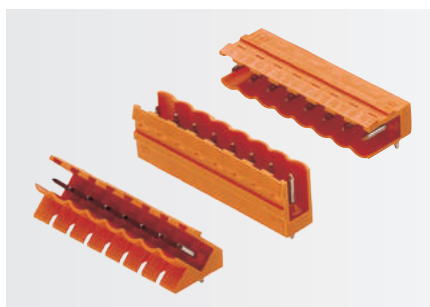

**Safe under vibration and shock**

- Vibration proof connection between male header and female plug
- The male header can also be screwed to the PCB
- Available with gold-plated surfaces

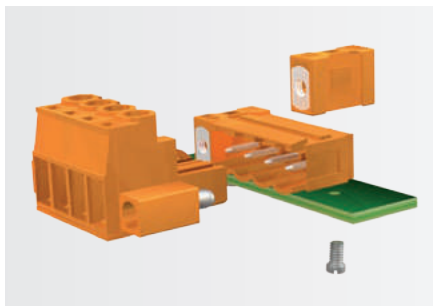

**Specified to fit your assembly process**

Gold-plated male headers have gold plating on the functional surfaces but not on the solder surfaces. This prevents contamination of the solder bath.



G

**Integrated to fit your design**

Adaptable connection system - the colour of the plug connectors fits to the device design and not the other way around.

**Extensive accessories**

- Light guides carry signals from the PCB LEDs to the front plate
- Partitions can be used to visually separate the different functional areas of the male header.
- All male headers can be manually coded or ordered as pre-coded headers.



# Female plug BLZP 5.0x HC

## Pluggable, universal screw connection

The BLZP is the functional extension of the BLZ series, which has proven itself on the market for decades.

The “P” in the part name stands for a “plus” in security and the “HC” a “plus” in performance during processing and usage. Resulting from this are additional customer benefits, such as a continuous function and safety chain, increased efficiency and process reliability and much more user friendly operation.



### Folded steel clamping yoke

When the screw on the clamp is tightened, there is a counter effect in the clamping yoke's threaded area. This ensures a maintenance free and durable gas-tight connection. In addition, the elastic behaviour of the clamping yoke compensates for the setting of the connected wire and any temperature induced deviations.



### Hybrid contacts

The current bar and the tulip contact are made from two different materials and then welded together. The current bar has high conductivity and the tulip contact is characterised by its excellent spring properties.



### Safe connection – error-free wiring

The integrated “wire guard” feature prevents dangerous insertion of the wire below the clamping area and thus protects against contact or insertion errors.

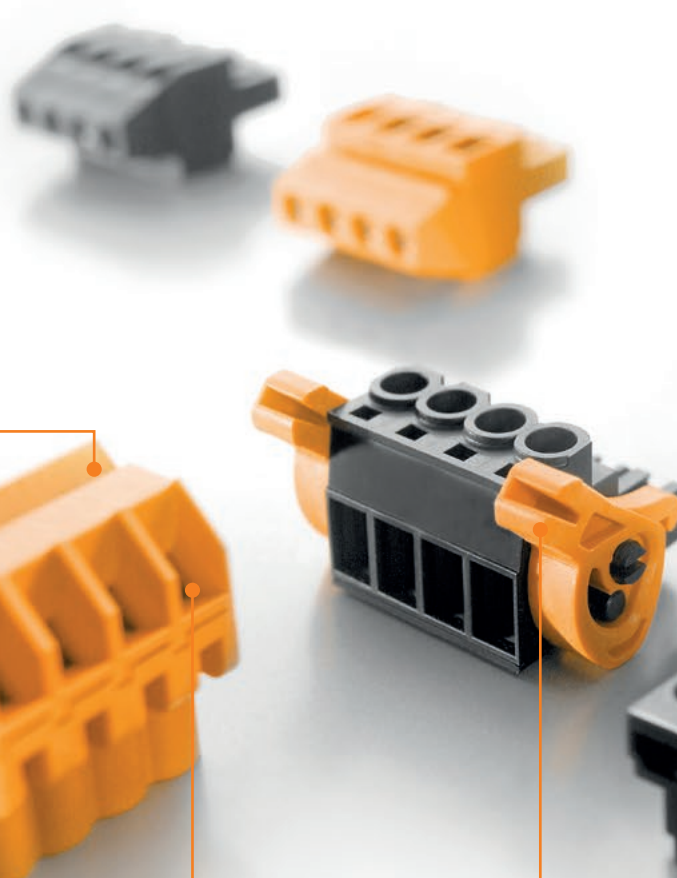

**Safe contacting – universal operation**

The globally compatible screw head (in conformity with ISO 2880/2, ISO 8764/2-PH and ISO 8764/2-PHZ) that fits all tools – for non-positive and uncomplicated operation with common hand tools or the efficient use of power tools.

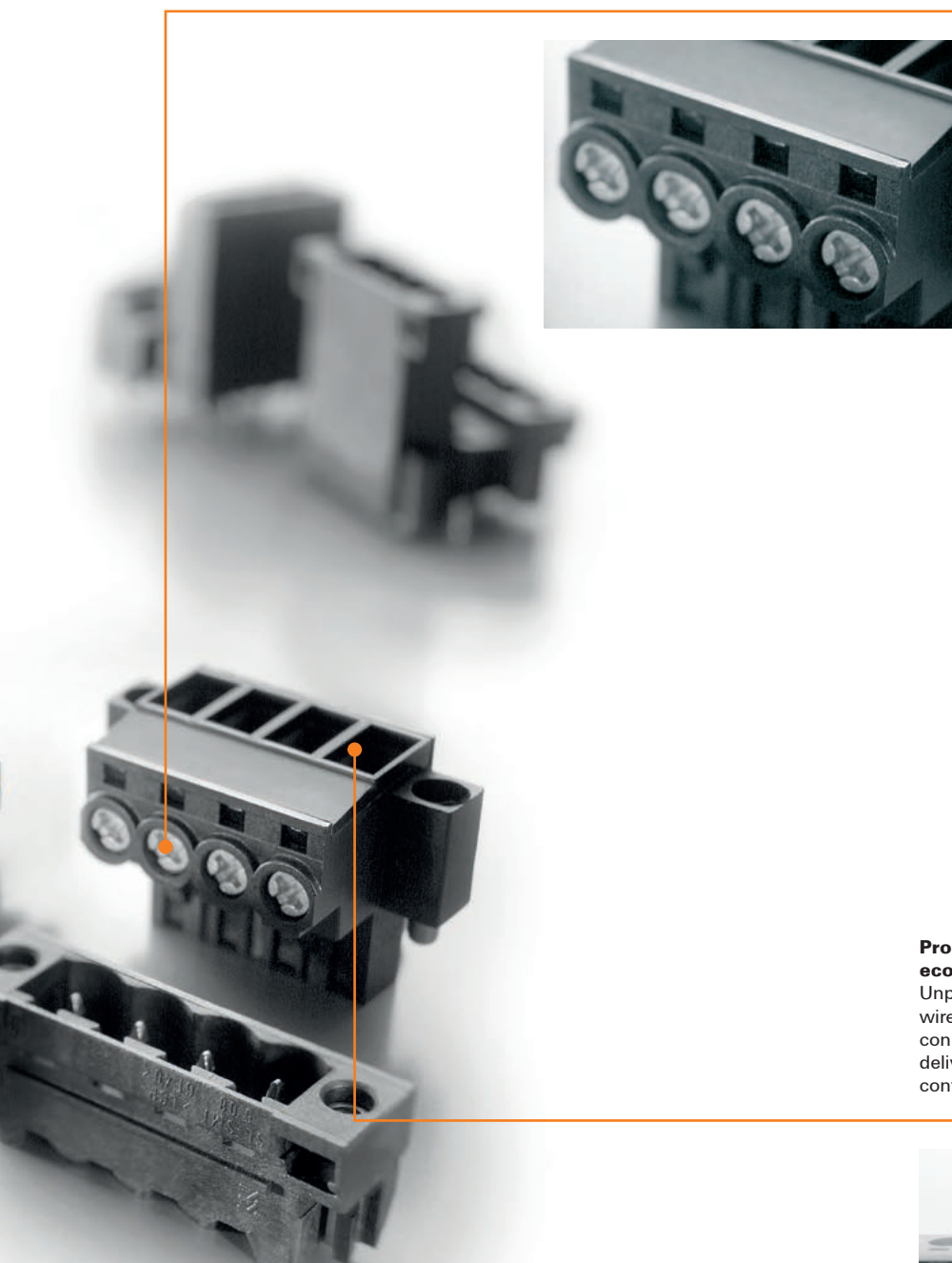

**Conductor outlet direction up/down**



**Conductor outlet direction straight/inclined**



**Locking options**

F = screw flange / LR = Lock & Release lever



**Process-compatible by default – economical processing**

Unpack – wire ready – connect up. Our wire-ready technology makes sure that all connecting points are completely opened when delivered, even after global transport (in conformity with ISO 13355).

**Securely lock – simply release**

Fast, self-locking with the male header for tool-free handling. Releasing of the female plug is gentle on components.

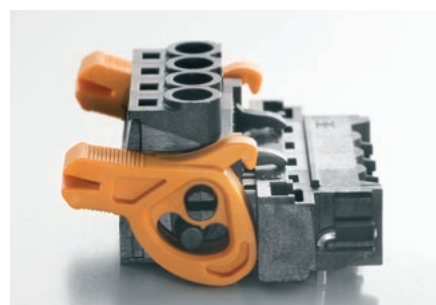
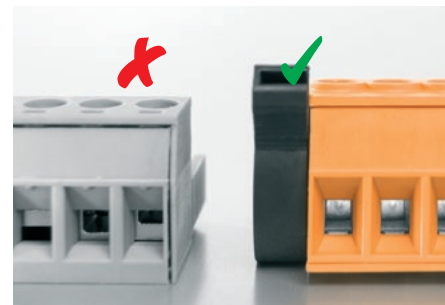

## Female plug BLT 5.08 HC

### The specialist for tight installation spaces

The BLT range is the most compact TOP connection of its type available in 5.08 mm pitch. This greatly simplifies device design because the cable entry and screw are located in the same plane of the plug-in connector. With the wire connection parallel to the circuit board, the BLT is specialised for use in limited installation spaces and high packing densities. HC represents additional performance.



#### High component density

Normal screw terminals have a 90° angle between the directions of the cable entry and the screw. The required space must then be taken into account when designing the device. However with the TOP connection system, the directions for wire entry and clamping operations are the same.

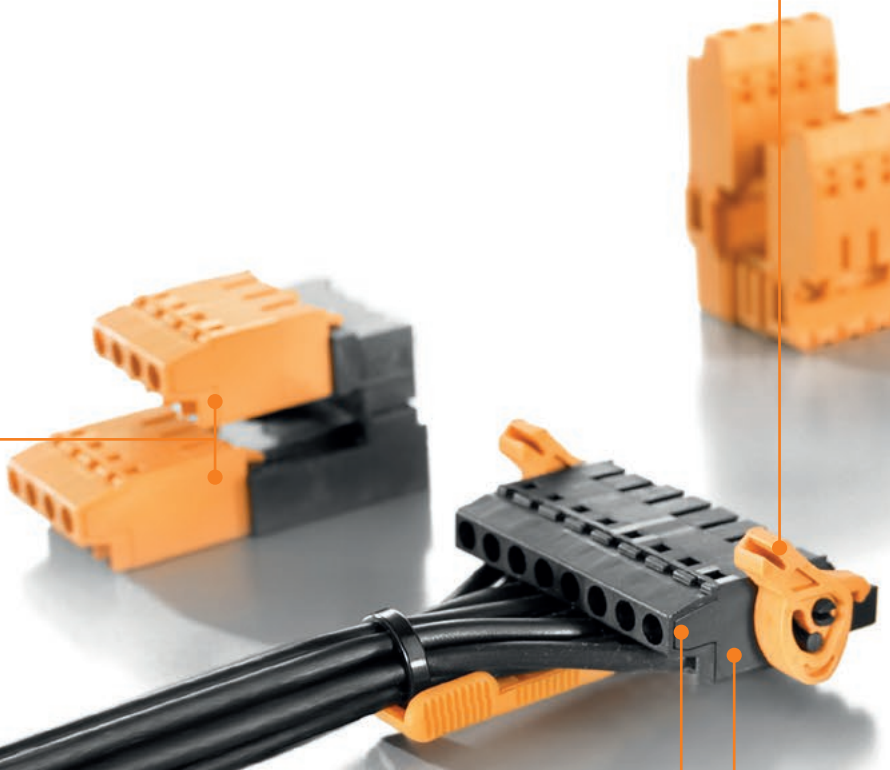
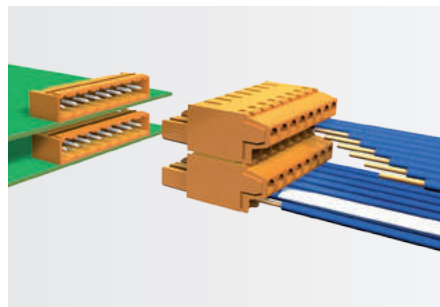

#### Hybrid contacts

For every function, the best material. The current bar and the tulip contact are made from two different materials and then welded together. The current bar has high conductivity and the tulip contact is characterised by its excellent spring properties.



**Secure interlock and simple release**

Fast, self-locking with the male header for tool-free handling. Releasing of the female plug is gentle on components.

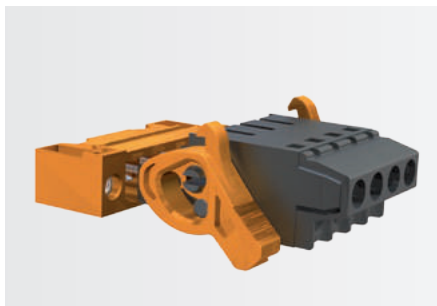

**Process-compatible by default – economical processing**

Unpack – “Wire Ready” – Connect. The “Wire Ready” technology ensures that all clamping units are fully open on delivery, even after world-wide shipping.

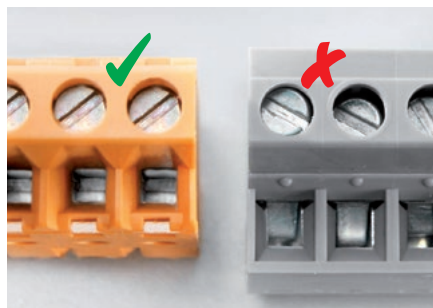
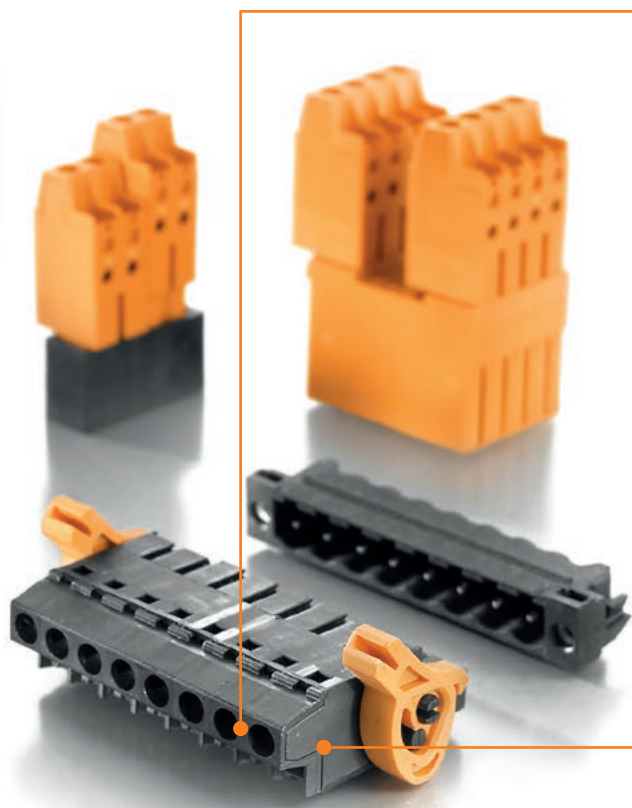

**Safe to use with no-fault wiring:**

The BLT’s “pull effect” ensures that the connected wire is pulled in to the clamping point for a securely established contact.



**Minimal height**

With a height of only 12.2 mm, the BLT is currently the smallest TOP connection available.

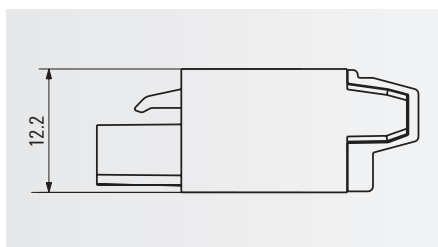

# Female plug BLF 5.0x HC and BLDF 5.08 PUSH IN for fast conductor connection without any tools



The quick PUSH IN connection is now also available in pitches of 5.00 mm and 5.08 mm. The products are simple, safe and can be used in a variety of applications: The plugs are available for all wire outlet directions (90°, 180° and 270°) and also as a double connector with integrated cross-connection for bus applications.

HC represents additional performance.

The hybrid contacts used in combination with PUSH IN guarantee a vibration resistant and maintenance free connection, even under extreme conditions.

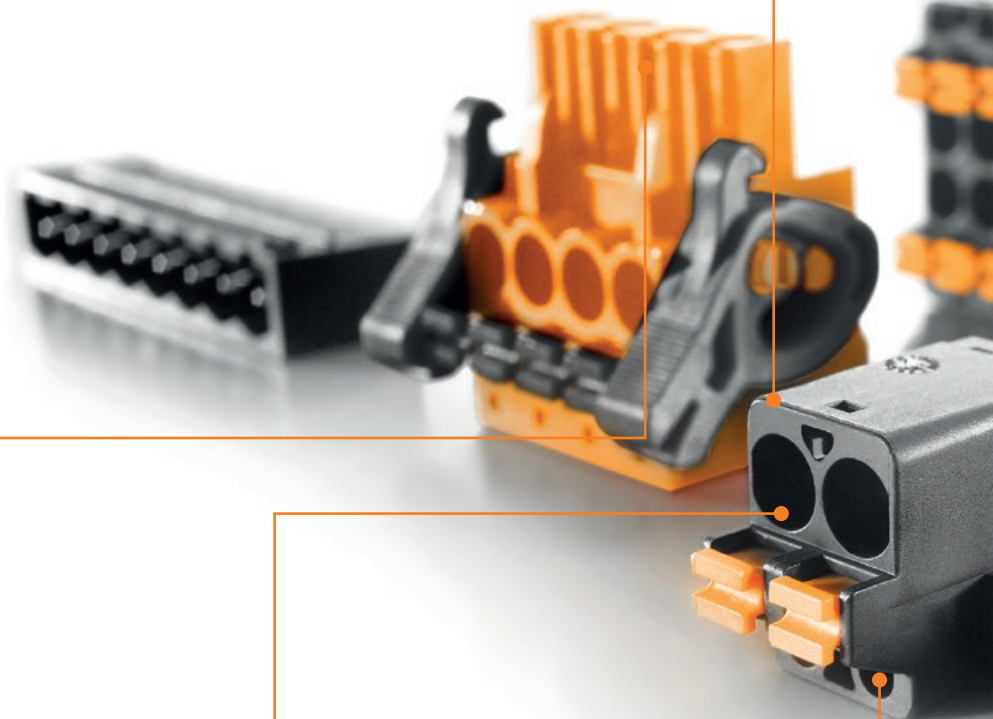

## G

### Hybrid contacts

The current bar and the tulip contact are made from two different materials and then welded together. The current bar has high conductivity and the tulip contact is characterised by its excellent spring properties.



### Can be tested at any time

Simplified functional testing using easily accessible diagnostic test points.

### All-purpose usage

Very large clamping range from 0.2 mm<sup>2</sup> to 2.5 mm<sup>2</sup> –even when using ferrules with plastic collars.

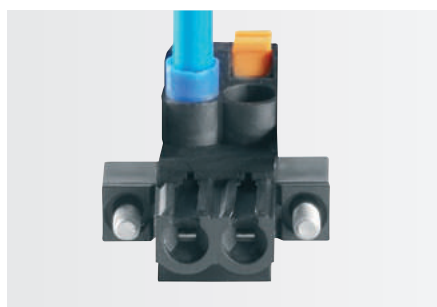



**Safe to operate**

Rounded edges and large, non-slip control buttons ensure user-friendly operation.



**Extremely durable**

The integrated cross-connector is designed for a low voltage drop and allows a powerful 22 A bus power which can supply a high number of notes in the bus system.

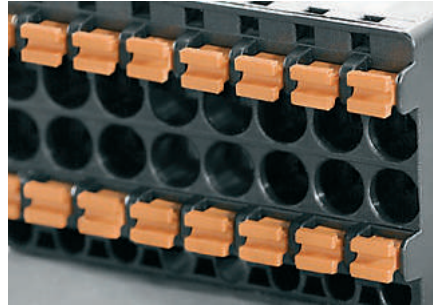

**All-round safety**

A stainless steel cage enclosure prevents subsidence in the contact area. To prevent any drop in clamping force plastic parts were deliberately not used.



**Directly plugged in**

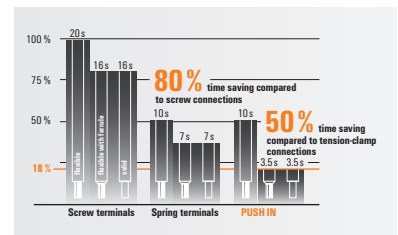

**Simply fast**

**PUSH IN:** tool-free connections of pre-prepared wires into the wire-entry funnel. [www.PUSH-IN.com](http://www.PUSH-IN.com)

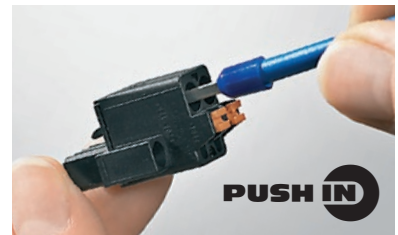

**Simple and self-explanatory**

Intuitive opening of the terminal point using conspicuous push buttons.

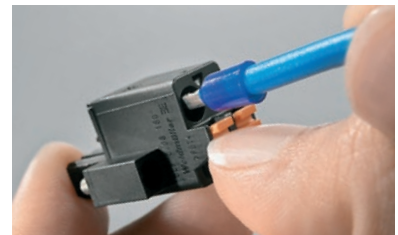

## Female plug BLC 5.08

### Cost effective and pre-assembled using a crimp connection

The BLC product family with crimp connections provides an affordable solution with pre-assembled female plugs that is also appropriate for large batch jobs. The contacts can be crimped by using hand tools or with a crimping machine in the factory when producing large batches.

#### Minimal height

With a height of only 12.2 mm, the BLT is currently the smallest TOP connection available.

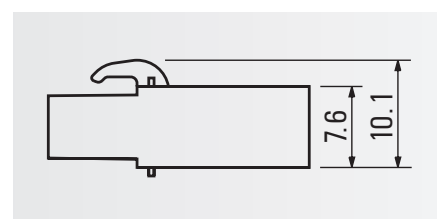

#### Effective and cost-effective

By using high performance metals, a costly over-spring on the tulip contact can be avoided. This cost saving is passed directly to the customer.

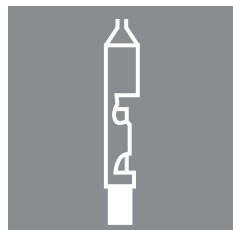

#### Process-compatible by default – economical processing

Delivery of the crimp contacts loose in bags, or as tape-packaged carrier strips. For the following conductor sizes: 0.22 to 0.35 mm<sup>2</sup>, 0.50 to 1.00 mm<sup>2</sup>, 1.50 to 2.50 mm<sup>2</sup>.

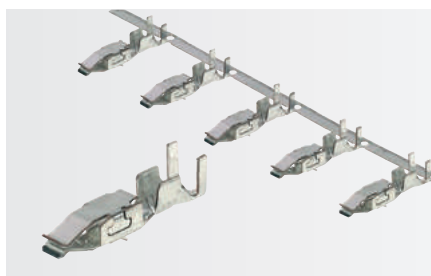

**Flexible for a variety of applications**

Affordable machine crimping or with hand tools in the field.



**High component density**

Screw terminals have a 90° angle between the directions of the cable entry and the screw. The required space must then be taken into account when designing the device. In the crimp connector system, however, the conductor insertion and operation is parallel to the circuit board.

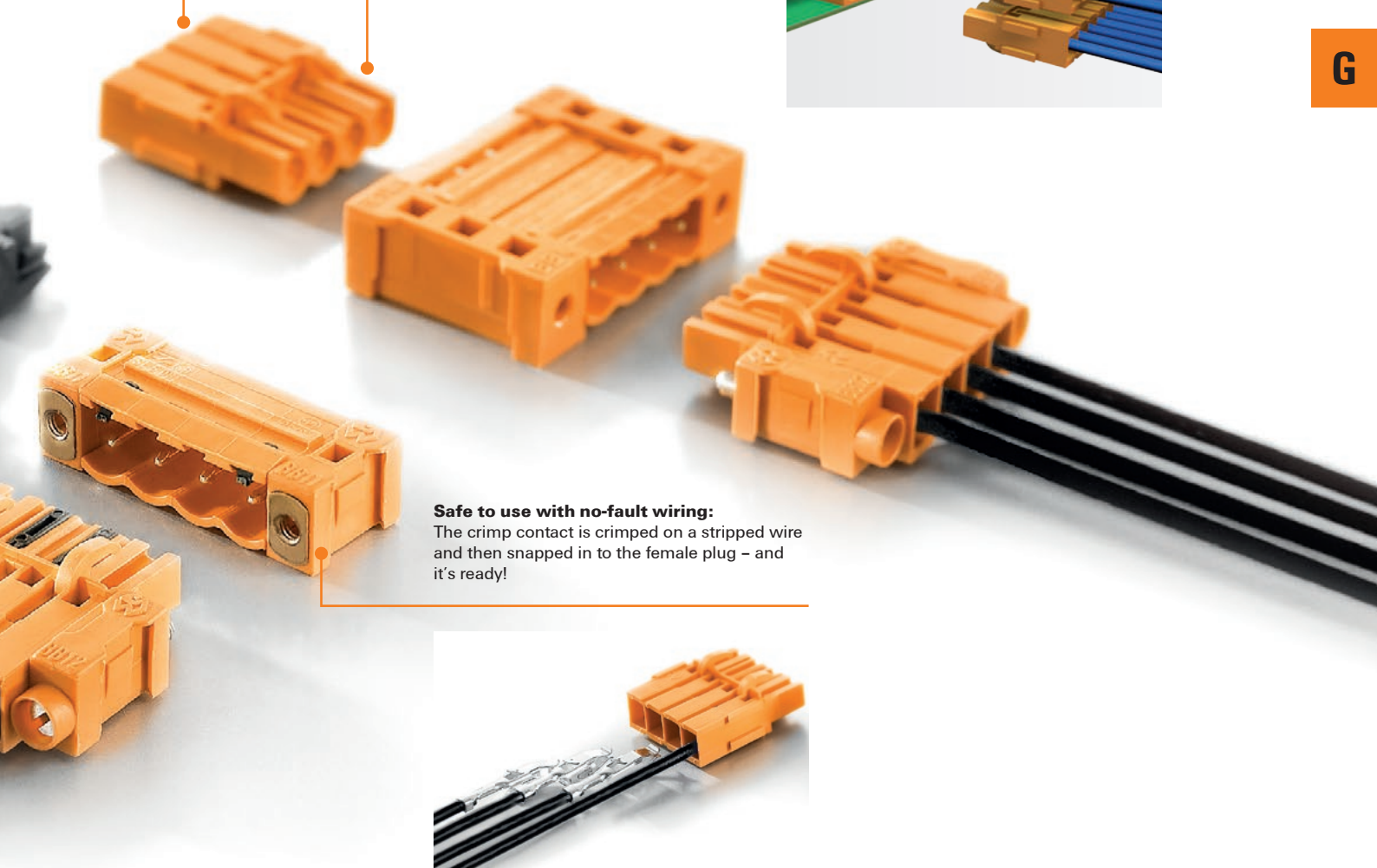
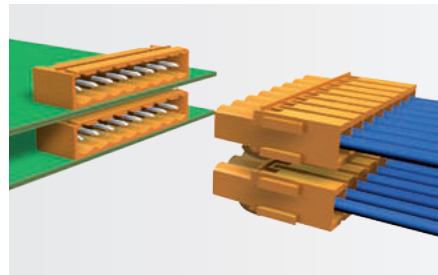

**Safe to use with no-fault wiring:**

The crimp contact is crimped on a stripped wire and then snapped in to the female plug – and it's ready!

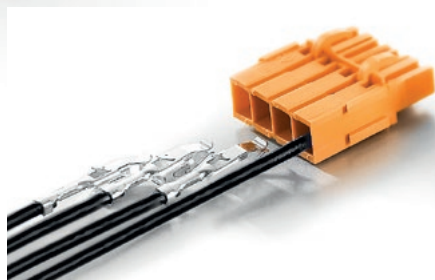

<http://www.OMNIMATE.net>

- = Wire-to-Board
- = Board-to-Board
- = Wire-to-Wire
- = Board-to-Wire

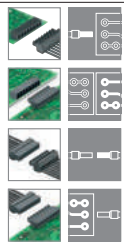

**Orientation**

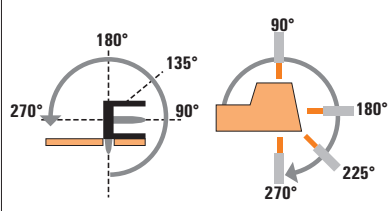

**Male header**

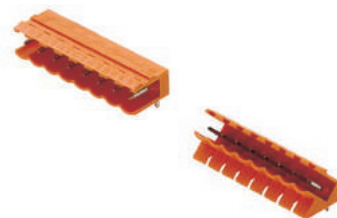

**BL/SL 5.00 series**



Type	Levels		1		
	Orientation		SL	SL	
	Flange options		(O)/B	(O)/B	
	IEC / UL		IEC: 400 V/18 A UL: 300 V/15 A	IEC: 400 V/17 A UL: 300 V/15 A	
<b>Female plug</b>  <b>Screw: Clamping yoke</b>  <b>Spring: PUSH IN</b>		<b>BLZP HC</b> 180° (G)/F/LR	IEC: 400 V/19 A/0.2 - 4 mm <sup>2</sup> UL: 300 V/10 A/AWG 26 - 12	○	○
		<b>BLZP HC</b> 90° (G)/F/LR	IEC: 400 V/15.5 A/0.2 - 4 mm <sup>2</sup> UL: 300 V/10 A/AWG 26 - 12	○	○
		<b>BLZP HC</b> 270° (G)/F/LR	IEC: 400 V/15.5 A/0.2 - 4 mm <sup>2</sup> UL: 300 V/10 A/AWG 26 - 12	○	○
		<b>BLF HC</b> 180° (G)/F/LR	IEC: 400 V/20.5 A/0.2 - 2.5 mm <sup>2</sup> UL: 300 V/10 A/AWG 26 - 12	○	○
		<b>BLF HC</b> 90° (G)/F/LR	IEC: 400 V/20 A/ 0.2 - 2.5 mm <sup>2</sup> UL: 300 V/10 A/ AWG 26 - 12	○	○

**Female plug and header:**

- (G)\* = Closed (without flange)
- F = Flange with screw
- LR = Lock & Release lever
- HC = High current

\* not included in the article description

**Male header and plug:**

- (O)\* = open
- B = Dovetail for fixing blocks with a nut
- G = closed
- F = Screw flange with nut
- LF = Solder flange with nut
- GLF = closed with additional solder flange
- FLF = Flange with nut and additional solder flange
- HC = High current

Male header



Solder connection







Reflow solder connection



1		2		1		1		2
SL	SLD	SLD	SL-SMT HC	SL-SMT HC	SL-SMaT HC	SL-SMaT HC	SLDV-THR	
180°	90°	180°	90°	180°	90°	180°	180°	180°
(0)/B	G	G	(0)/G/LF	(0)/G/LF	(0)	(0)	(0)	G/GLF/F/FLF
IEC: 400 V/18 A UL: 300 V/15 A	IEC: 400 V/11 A UL: 300 V/10 A	IEC: 400 V/11 A UL: 300 V/10 A	IEC: 400 V/19 A UL: 300 V/15 A	IEC: 400 V/19 A UL: 300 V/15 A	IEC: 400 V/16.5 A UL: 300 V/15 A	IEC: 400 V/16.5 A UL: 300 V/15 A	IEC: 400 V/15 A UL: 300 V/10 A	IEC: 400 V/15 A UL: 300 V/10 A
○	○	○	○	○	○	○	○	○
○			○	○	○	○	○	○
○			○	○	○	○	○	
○	○	○	○	○	○	○	○	○
○			○	○	○	○	○	○

G

<http://www.OMNIMATE.net>

-  = Wire-to-Board
-  = Board-to-Board
-  = Wire-to-Wire
-  = Board-to-Wire

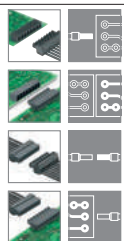

**Orientation**

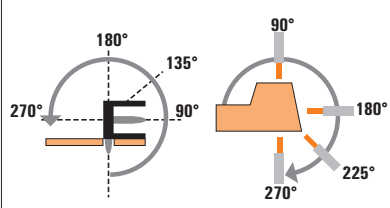



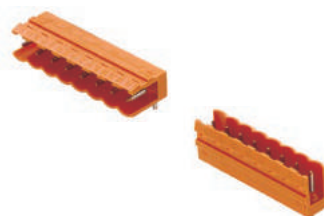







  
**Solder connection**



**BL/SL 5.08 series, Part 1 of 3**



Type	Levels	
	1	
	SL HC	SL HC
	90°	180°
Orientation	(O)/G/B/F/LF	(O)/G/B/F/LF
Flange options		
IEC / UL	IEC: 400 V/24 A UL: 300 V/15 A	IEC: 400 V/24 A UL: 300 V/16 A

	Type	Orientation	Flange options	IEC / UL	Levels	
					SL HC	SL HC
Female plug	Clamping yoke	 <b>BLZP HC</b> 180° (G)/F/LR IEC: 400 V/19 A/0.2 - 4 mm <sup>2</sup> UL: 300 V/10 A/AWG 26 - 12	○	○		
		 <b>BLZP HC</b> 90° (G)/F/LR IEC: 400 V/15.5 A/0.2 - 4 mm <sup>2</sup> UL: 300 V/10 A/AWG 26 - 12	○	○		
		 <b>BLZP HC</b> 270° (G)/F/LR IEC: 400 V/15.5 A/0.2 - 4 mm <sup>2</sup> UL: 300 V/10 A/AWG 26 - 12	○	○		
		 <b>BLZP HC</b> 225° (G)/F/LR IEC: 400 V/17.5 A/0.2 - 4 mm <sup>2</sup> UL: 300 V/10 A/AWG 26 - 12	○	○		
	TOP	 <b>BLT HC</b> 180° (G)/F/LR/DF IEC: 400 V/17 A/0.2 - 2.5 mm <sup>2</sup> UL: 300 V/10 A/AWG 26 - 14	○	○		
	Clamping yoke (twin connector)	 <b>BLZ QV</b> 180° (G) IEC: 400 V/17.5 A/0.2 - 2.5 mm <sup>2</sup> UL: 300 V/15 A/AWG 26 - 14	○	○		
		 <b>BLDZ DN DeviceNet™</b> 180° (G)/F IEC: 400 V/16 A/0.2 - 2.5 mm <sup>2</sup> UL: 300 V/15 A/AWG 22 - 12	○	○		
		 <b>BLDT</b> 180° (G) IEC: 400 V/14 A/0.2 - 2.5 mm <sup>2</sup> UL: 300 V/10 A/AWG 26 - 12	○	○		
	Female header	Solder connection	 <b>BLL</b> 90° (G)/FI IEC: 400 V/23 A UL: 300 V/15 A	●	●	
 <b>BLL</b> 180° (G)/B IEC: 400 V/23 A UL: 300 V/15 A			●	●		

**Female plug and header:**

- (G)\* = Closed (without flange)
- F = Flange with screw
- DF = Implementation

- LR = Lock & Release lever
- B = Dovetail for fixing blocks with a nut
- FI = Inverted flange with nut

- HC = High current
- \* not included in the article description

Male header



Solder connection



Reflow solder connection

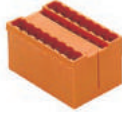

	2				1		
	SLD	SLD	SLDV	SLDV	SL-SMT HC	SL-SMT HC	SL-SMT HC
	90°	180°	90°	180°	90°	180°	270°
	G	G	(O)/B	(O)/B	(O)/G/F/LF	(O)/G/F/LF	G/LF
	IEC: 400 V/11 A UL: 300 V/10 A	IEC: 400 V/14 A UL: 300 V/10 A	IEC: 400 V/17 A UL: 300 V/10 A	IEC: 400 V/17 A UL: 300 V/10 A	IEC: 400 V/19 A UL: 300 V/15 A	IEC: 400 V/19 A UL: 300 V/15 A	IEC: 400 V/19 A UL: 300 V/15 A
	○	○	○	○	○	○	○
			○	○	○	○	○
					○	○	○
	○	○			○	○	○
	○	○	○	○	○	○	○
	○	○	○	○	○	○	○
					○	○	○
					○	○	○
	●	●	●	●	●	●	●
	●	●	●	●	●	●	●

Male header and plug:





- (O)\* = open
- B = Dovetail for fixing blocks with a nut
- G = closed

- F = Screw flange with nut
- LF = Solder flange with nut
- DF = Implementation

- HC = High current
- \* not included in the article description



<http://www.OMNIMATE.net>

-  = Wire-to-Board
-  = Board-to-Board
-  = Wire-to-Wire
-  = Board-to-Wire

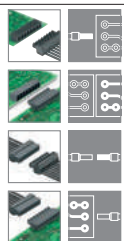

**Orientation**

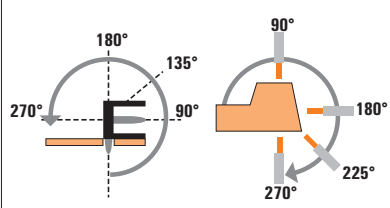

**Male header**



Reflow solder connection

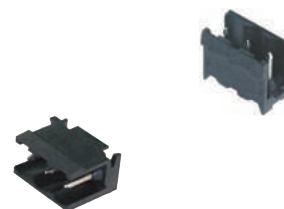

**BL/SL 5.08 series Part 2 of 3**



Type	Levels	
	1	
	SL-SMaT HC	SL-SMaT HC
	Orientation	90°
Flange options	(0)	(0)
IEC / UL	IEC: 400 V/16.5 A UL: 300 V/15 A	IEC: 400 V/16.5 A UL: 300 V/15 A

Female plug	Clamping yoke	BLZP HC	180° (G)/F/LR	IEC: 400 V/19 A/0.2 - 4 mm <sup>2</sup> UL: 300 V/10 A/AWG 26 - 12	○	○
				BLZP HC	90° (G)/F/LR	IEC: 400 V/15.5 A/0.2 - 4 mm <sup>2</sup> UL: 300 V/10 A/AWG 26 - 12
		BLZP HC	270° (G)/F/LR	IEC: 400 V/15.5 A/0.2 - 4 mm <sup>2</sup> UL: 300 V/10 A/AWG 26 - 12	○	○
		BLZP HC	225° (G)/F/LR	IEC: 400 V/17.5 A/0.2 - 4 mm <sup>2</sup> UL: 300 V/10 A/AWG 26 - 12	○	○
	TOP	BLT HC	180° (G)/F/LR/DF	IEC: 400 V/17 A/0.2 - 2.5 mm <sup>2</sup> UL: 300 V/10 A/AWG 26 - 14	○	○
Female plug	Clamping yoke (twin connector)	BLZ QV	180° (G)	IEC: 400 V/17.5 A/0.2 - 2.5 mm <sup>2</sup> UL: 300 V/15 A/AWG 26 - 14	○	○
		BLDZ DN DeviceNet™	180° (G)/F	IEC: 400 V/16 A/0.2 - 2.5 mm <sup>2</sup> UL: 300 V/15 A/AWG 22 - 12	○	○
		BLDT	180° (G)	IEC: 400 V/14 A/0.2 - 2.5 mm <sup>2</sup> UL: 300 V/10 A/AWG 26 - 12	○	○
Female header	Solder connection	BLL	90° (G)/FI	IEC: 400 V/23 A UL: 300 V/15 A	●	●
		BLL	180° (G)/B	IEC: 400 V/23 A UL: 300 V/15 A	●	●

**Female plug and header:**

- (G)\* = Closed (without flange)
- F = Flange with screw
- DF = Implementation

- LR = Lock & Release lever
- B = Dovetail for fixing blocks with a nut
- FI = Inverted flange with nut

- HC = High current
- \* not included in the article description



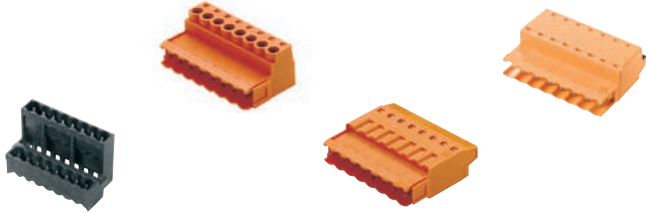
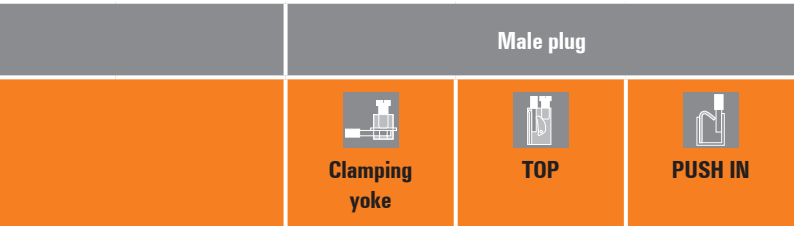

	2	1		1
	SLDV-THR	SLS	SLT	SLF
	180°	180°	180°	180°
	G/FLF	(0)/B/F/FI/DF	B/F/FI/DF	(0)/B/F/FI/DF
	IEC: 400 V/15 A UL: 300 V/10 A	IEC: 400 V/21.5 A/ 0.2 - 2.5 mm <sup>2</sup> UL: 300 V/15 A/ AWG 26 - 12	IEC: 400 V/16 A/ 0.2 - 2.5 mm <sup>2</sup> UL: 300 V/10 A/ AWG 26 - 12	IEC: 400 V/21.5 A/ 0.2 - 2.5 mm <sup>2</sup> UL: 300 V/15 A/ AWG 26 - 12
	○	●	●	●
	○	●	●	●
		●	●	●
		●	●	●
	○	●	●	●
	○	●	●	●
		●	●	●
		●	●	●
	●	●	●	●
	●	●	●	●

**Male header and plug:**

- (0)\* = open
- B = Dovetail for fixing blocks with a nut
- G = closed

- F = Screw flange with nut
- LF = Solder flange with nut
- DF = Implementation

\* not included in the article description



<http://www.OMNIMATE.net>

- = Wire-to-Board
- = Board-to-Board
- = Wire-to-Wire
- = Board-to-Wire

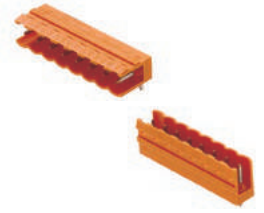
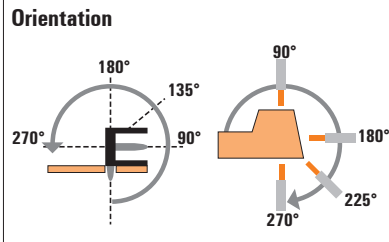
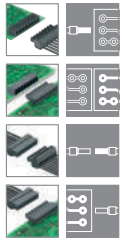

**BL/SL 5.08 series Part 3 of 3**



Type	Levels	
	1	
	SL HC	SL HC
	Orientation	90°
Flange options	(O)/G/B/F/LF	(O)/G/B/F/LF
IEC / UL	IEC: 400 V/24 A UL: 300 V/15 A	IEC: 400 V/24 A UL: 300 V/16 A

Female plug	PUSH IN		BLF HC	180°	(G)/F/LR/DF	IEC: 400 V/24 A/0.2 - 2.5 mm <sup>2</sup> UL: 300 V/16 A/AWG 12 - AWG 26	○	○	
		PUSH IN (twin connector)		BLDF	180°	(G)/F/LR	IEC: 400 V/26.1 A/0.2 - 2.5 mm <sup>2</sup> UL: 300 V/10 A/AWG 26-12	○	○
				BLC	180°	(G)/B	IEC: 400 V/21 A UL: 300 V/10 A	○	○

**Female plug and header:**

- (G)\*** = Closed (without flange)
- F** = Flange with screw
- LR** = Lock & Release lever

- DF** = Implementation
- B** = Dovetail for fixing blocks with a nut
- HC** = High current

\* not included in the article description

Male header								Male plug			
 Solder connection				 Reflow solder connection				 PUSH IN			



	2				1			1		2	1
	SLD	SLD	SLDV	SLDV	SL-SMT HC	SL-SMT HC	SL-SMT HC	SL-SMarT HC	SL-SMarT HC	SLDV-THR	SLF
	90°	180°	90°	180°	90°	180°	270°	90°	180°	180°	180°
	G	G	(O)/B	(O)/B	(O)/G/F/FLF	(O)/G/F/FLF	G/FLF	(O)	(O)	G/FLF	B/F/FL/DF
	IEC: 400 V/11 A UL: 300 V/10 A	IEC: 400 V/14 A UL: 300 V/10 A	IEC: 400 V/17 A UL: 300 V/10 A	IEC: 400 V/17 A UL: 300 V/10 A	IEC: 400 V/19 A UL: 300 V/15 A	IEC: 400 V/19 A UL: 300 V/15 A	IEC: 400 V/19 A UL: 300 V/15 A	IEC: 400 V/16.5 A UL: 300 V/15 A	IEC: 400 V/16.5 A UL: 300 V/15 A	IEC: 400 V/15 A UL: 300 V/10 A	IEC: 400 V/21.5 A/ 0.2 - 2.5 mm <sup>2</sup> UL: 300 V/15 A/ AWG 26 - 12
	○	○	○	○	○	○	○	○	○	○	●
			○	○	○	○	○	○	○	○	●
					○	○	○	○	○		●
	○	○	○	○	○	○	○	○	○	○	●
	○	○	○	○	○	○	○	○	○	○	●

**Male header and plug:**

- (O)\* = open
- B = Dovetail for fixing blocks with a nut
- G = closed

- F = Screw flange with nut
- LF = Solder flange with nut
- FLF = Flange with nut and additional solder flange

- HC = High current
- \* not included in the article description

G

## Connectors in 5.00 mm pitch Series BL/SL 5.00

### SL-SMT 5.00HC../90

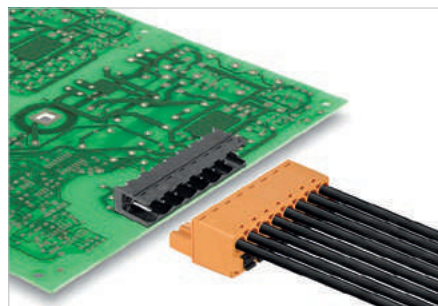

High-temperature-resistant, 90°-angled male header, optimised for SMT processing. The male headers can be manually coded or ordered as pre-coded headers.

- Available in open, closed (G) or with solder Flange (LF).
- The solder flange makes an additional screw-fixation to the PCB unnecessary and protects the solder joints against mechanical stress.
- Available with 1.5 mm or 3.2 mm solder pins.
- Packed either in box (BX) or an anti-static roll (tape-on-reel, RL)
- The 1.5 mm solder pin reduces the solder paste to a minimum without losing holding force to the PCB.

### Product data

IEC: 400 V / 27.5 A  
UL: 300 V / 18.5 A



For additional articles and information, refer to [catalog.weidmueller.com](http://catalog.weidmueller.com)

#### Note:

- Gold-plated contact surfaces on request
- Rated current related to rated cross-section & min. No. of poles.
- Diameter of solder eyelet  $D = 1.4 \pm 0.1$  mm
- Solder eyelet diameter  $D = 1.5 \pm 0.1$  mm, from 9 poles
- P on drawing = pitch
- Rated data refer only to the component itself. Clearance and creepage distances to other components are to be designed in accordance with the relevant application standards.

### SL-SMT 5.00HC../90 Box

#### Packaged in box



#### Dimensioned drawing

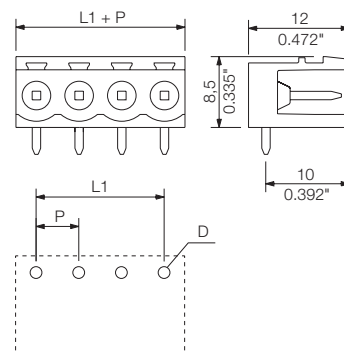

### Technical data

#### In compliance with IEC 60664-1 / IEC 61984

Clamping range, max.			
<b>Solid core H05(07) V-U</b>			
Stranded H07 V-R			
Flexible H05(07) V-K			
Flexible with ferrule			
Ferrule with plastic collar			
Stripping length			
Screwdriver blade	mm		
According to norm			
Tightening torque range			
<b>Rated current, max.</b>	<b>A</b>	<b>27.5</b>	<b>24</b>
At ambient temperature		20°C	40°C
For conductor cross-section			
Overvoltage category		III	III
Pollution severity		3	2
<b>Rated voltage</b>	<b>V</b>	<b>250</b>	<b>320</b>
Rated impulse voltage	kV	4	4
<b>UL / CUL (Use Group)</b>	<b>B</b>	<b>C</b>	<b>D</b>
<b>Rated voltage</b>	<b>V</b>	<b>300</b>	<b>300</b>
<b>Rated current</b>	<b>A</b>	<b>18.5</b>	<b>10</b>
<b>AWG conductor</b>	<b>AWG</b>	-	-
<b>CSA (Use Group)</b>	<b>B</b>	<b>C</b>	<b>D</b>
Rated voltage	V	300	300
Rated current	A	15	15
AWG conductor	AWG	-	-
<b>General data</b>			
Type of insulation material	LCP GF		
UL 94 flammability rating	V-0		
Contact base material	CuMg		
Material of contact surface	tinned		
Pin dimensions = d	mm	1.2, Octagonal	
Solder eyelet Ø = D	mm	1.4	
Solder eyelet Ø tolerance	mm	+ 0,1	

### Accessories

Note: Refer to the Accessories chapter for additional accessories.

Coding	Order No.
BLZ/SL KO OR BX	<b>1573010000</b>
BLZ/SL KO BK BX	<b>1545710000</b>
<b>Partition element</b>	
SL AT OR	<b>1598300000</b>
SL AT SW	<b>1770240000</b>
<b>LED light guide</b>	
SL FLA 1.5/1	<b>1580100000</b>
SL FLA 2,3/1	<b>1636670000</b>
SL FLA 2,3/24	<b>1636680000</b>
SL FLA 3,8/1	<b>1580110000</b>
SL FLA 9,0/1	<b>1580120000</b>

### Ordering data

Solder pin length		3.2 mm		
Colour		Black		
Pitch	5.00 mm			
Pol.	L1	(inch)	Qty.	Order No.
2	5.00	0.197	100	<b>1839890000</b>
3	10.00	0.394	100	<b>1839900000</b>
4	15.00	0.591	100	<b>1839910000</b>
5	20.00	0.787	50	<b>1839920000</b>
6	25.00	0.984	50	<b>1839930000</b>
7	30.00	1.181	50	<b>1839940000</b>
8	35.00	1.378	50	<b>1839950000</b>
9	40.00	1.575	50	<b>1839960000</b>
10	45.00	1.772	50	<b>1839970000</b>
11	50.00	1.969	50	<b>1839980000</b>
12	55.00	2.165	50	<b>1839990000</b>
13	60.00	2.362	50	<b>1840000000</b>
14	65.00	2.559	50	<b>1840010000</b>
15	70.00	2.756	50	<b>1840020000</b>
16	75.00	2.953	50	<b>1840030000</b>
17	80.00	3.150	20	<b>1840040000</b>
18	85.00	3.346	20	<b>1840050000</b>
19	90.00	3.543	20	<b>1840060000</b>
20	95.00	3.740	20	<b>1840070000</b>
21	100.00	3.937	20	<b>1840080000</b>
22	105.00	4.134	20	<b>1840090000</b>
23	110.00	4.331	20	<b>1840100000</b>
24	115.00	4.528	20	<b>1840110000</b>

### SL-SMT 5.00HC../90 Tape

Tape-on-reel



Dimensioned drawing

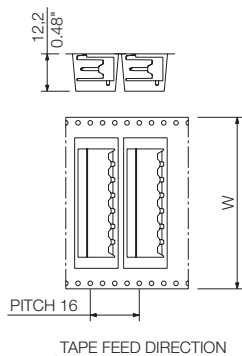

#### Ordering data

Solder pin length		1.5 mm	
Colour		Black	
Pitch		5.00 mm	
Pol.	L1 (inch)	Qty.	Order No.
2	5.00	0.197	350 1797620000
3	10.00	0.394	350 1797630000
4	15.00	0.591	350 1797640000
5	20.00	0.787	350 1797650000
6	25.00	0.984	350 1797660000
7	30.00	1.181	350 1797670000
8	35.00	1.378	350 1797680000

Tape widths: 32, 44, 56, 72, 88

### SL-SMT 5.00HC../90G Box

Packaged in box



Dimensioned drawing

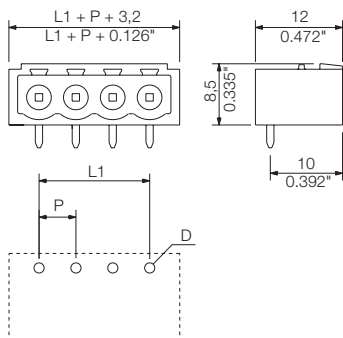

#### Ordering data

Solder pin length		3.2 mm	
Colour		Black	
Pitch		5.00 mm	
Pol.	L1 (inch)	Qty.	Order No.
2	5.00	0.197	100 1840120000
3	10.00	0.394	100 1840130000
4	15.00	0.591	100 1840140000
5	20.00	0.787	50 1840150000
6	25.00	0.984	50 1840160000
7	30.00	1.181	50 1840170000
8	35.00	1.378	50 1840180000
9	40.00	1.575	50 1840190000
10	45.00	1.772	50 1840200000
11	50.00	1.969	50 1840210000
12	55.00	2.165	50 1840220000
13	60.00	2.362	50 1840230000
14	65.00	2.559	50 1840240000
15	70.00	2.756	50 1840250000
16	75.00	2.953	50 1840260000
17	80.00	3.150	20 1840270000
18	85.00	3.346	20 1840280000
19	90.00	3.543	20 1840290000
20	95.00	3.740	20 1840300000
21	100.00	3.937	20 1840310000
22	105.00	4.134	20 1840320000
23	110.00	4.331	20 1840330000
24	115.00	4.528	20 1840340000

### SL-SMT 5.00HC../90G Tape

Tape-on-reel



Dimensioned drawing

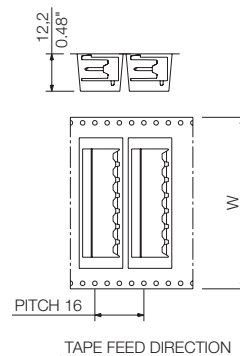

#### Ordering data

Solder pin length		1.5 mm	
Colour		Black	
Pitch		5.00 mm	
Pol.	L1 (inch)	Qty.	Order No.
2	5.00	0.197	350 1797690000
3	10.00	0.394	350 1797700000
4	15.00	0.591	350 1797710000
5	20.00	0.787	350 1797720000
6	25.00	0.984	350 1797730000
7	30.00	1.181	350 1797740000

Tape widths: 32, 44, 56, 72, 88

## Connectors in 5.00 mm pitch Series BL/SL 5.00

### SL-SMT 5.00HC../90

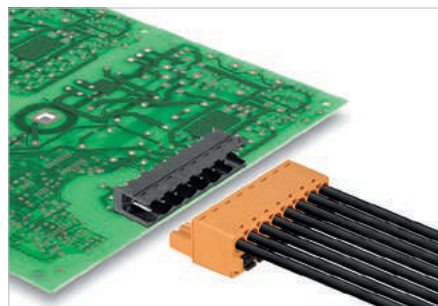

High-temperature-resistant, 90°-angled male header, optimised for SMT processing. The male headers can be manually coded or ordered as pre-coded headers.

- Available in open, closed (G) or with solder Flange (LF).
- The solder flange makes an additional screw-fixation to the PCB unnecessary and protects the solder joints against mechanical stress.
- Available with 1.5 mm or 3.2 mm solder pins.
- Packed either in box (BX) or an anti-static roll (tape-on-reel, RL)
- The 1.5 mm solder pin reduces the solder paste to a minimum without losing holding force to the PCB.

### Product data

IEC: 400 V / 27.5 A  
UL: 300 V / 18.5 A



For additional articles and information, refer to [catalog.weidmueller.com](http://catalog.weidmueller.com)

#### Note:

- Gold-plated contact surfaces on request
- Rated current related to rated cross-section & min. No. of poles.
- P on drawing = pitch
- Rated data refer only to the component itself. Clearance and creepage distances to other components are to be designed in accordance with the relevant application standards.

### SL-SMT 5.00HC../90LF Box

Packaged in box; with solder flange



#### Dimensioned drawing

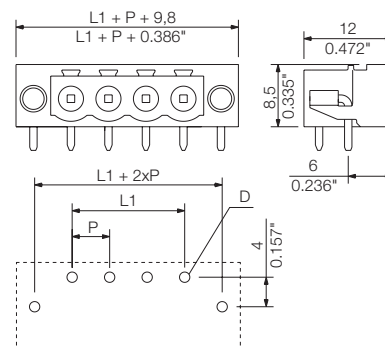

### Technical data

In compliance with IEC 60664-1 / IEC 61984			
Clamping range, max.			
<b>Solid core H05(07) V-U</b>			
Stranded H07 V-R			
Flexible H05(07) V-K			
Flexible with ferrule			
Ferrule with plastic collar			
Stripping length			
Screwdriver blade	mm		
According to norm			
Tightening torque range			
<b>Rated current, max.</b>	<b>A</b>	<b>27.5</b>	<b>24</b>
At ambient temperature		20°C	40°C
For conductor cross-section			
Overvoltage category		III	III II
Pollution severity		3	2 2
<b>Rated voltage</b>	<b>V</b>	<b>250</b>	<b>320 400</b>
Rated impulse voltage	kV	4	4 4
<b>UL / CUL (Use Group)</b>		<b>B</b>	<b>C D</b>
<b>Rated voltage</b>	<b>V</b>	<b>300</b>	<b>300</b>
<b>Rated current</b>	<b>A</b>	<b>18.5</b>	<b>10</b>
<b>AWG conductor</b>	<b>AWG</b>		
<b>CSA (Use Group)</b>		<b>B</b>	<b>C D</b>
Rated voltage	V	300	300
Rated current	A	15	15
AWG conductor	AWG		
<b>General data</b>			
Type of insulation material		LCP GF	
UL 94 flammability rating		V-0	
Contact base material		CuMg	
Material of contact surface		tinned	
Pin dimensions = d	mm	1.2, Octagonal	
Solder eyelet Ø = D	mm	1.5	
Solder eyelet Ø tolerance	mm	+ 0,1	

### Accessories

Note: Refer to the Accessories chapter for additional accessories.

Coding	Order No.
BLZ/SL KO OR BX	<b>1573010000</b>
BLZ/SL KO BK BX	<b>1545710000</b>
<b>Partition element</b>	
SL AT OR	<b>1598300000</b>
SL AT SW	<b>1770240000</b>
<b>LED light guide</b>	
SL FLA 1.5/1	<b>1580100000</b>
SL FLA 2,3/1	<b>1636670000</b>
SL FLA 2,3/24	<b>1636680000</b>
SL FLA 3,8/1	<b>1580110000</b>
SL FLA 9,0/1	<b>1580120000</b>

### Ordering data

Solder pin length		3.2 mm		
Colour		Black		
Pitch	5.00 mm			
Pol.	L1	(inch)	Qty.	Order No.
2	5.00	0.197	90	<b>1840350000</b>
3	10.00	0.394	72	<b>1840360000</b>
4	15.00	0.591	60	<b>1840370000</b>
5	20.00	0.787	54	<b>1840380000</b>
6	25.00	0.984	42	<b>1840390000</b>
7	30.00	1.181	42	<b>1840400000</b>
8	35.00	1.378	36	<b>1840410000</b>
9	40.00	1.575	30	<b>1840420000</b>
10	45.00	1.772	30	<b>1840430000</b>
11	50.00	1.969	24	<b>1840440000</b>
12	55.00	2.165	24	<b>1840450000</b>
13	60.00	2.362	24	<b>1840460000</b>
14	65.00	2.559	18	<b>1840470000</b>
15	70.00	2.756	18	<b>1840480000</b>
16	75.00	2.953	18	<b>1840490000</b>
17	80.00	3.150	18	<b>1840500000</b>
18	85.00	3.346	18	<b>1840510000</b>
19	90.00	3.543	12	<b>1840520000</b>
20	95.00	3.740	12	<b>1840530000</b>
21	100.00	3.937	12	<b>1840540000</b>
22	105.00	4.134	12	<b>1840550000</b>
23	110.00	4.331	12	<b>1840560000</b>
24	115.00	4.528	12	<b>1840570000</b>

## SL-SMT 5.00HC/./90LF Tape

Tape-on-reel; with solder flange



Dimensioned drawing

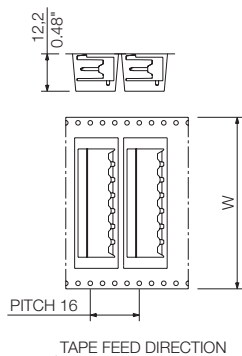

## Solder flange (LF)

Normally you use a pin header with fastening flanges (F) in combination with a screw from the rear side of the PCB to increase the fixation forces of the pin headers. The disadvantages are additional process steps that make the PCB mounting complex and cost intensive. The patented solder flange was designed to solve exactly this problem and find a simple and cheap solution. The additional solder pins substitute the present screw flanges and they get soldered together with the pin header. This terminates additional process steps and thus reduces production costs. The additional fixation protects the soldered connections from tensile strain and avoids permanent mechanical stress such as caused by the post-fastened screw forces.

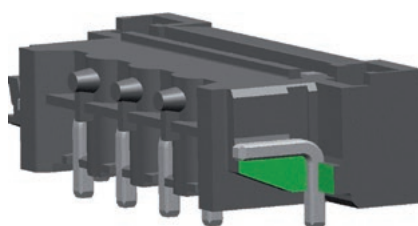

## Ordering data

Solder pin length		1.5 mm	
Colour		Black	
Pitch		5.00 mm	
Pol.	L1	(inch)	Qty. Order No.
2	5.00	0.197	350 <b>1797750000</b>
3	10.00	0.394	350 <b>1797760000</b>
4	15.00	0.591	350 <b>1797770000</b>
5	20.00	0.787	350 <b>1797780000</b>
6	25.00	0.984	350 <b>1797790000</b>

Tape widths: 32, 44, 56, 72, 88

## Connectors in 5.00 mm pitch Series BL/SL 5.00

### SL-SMT 5.00HC../180

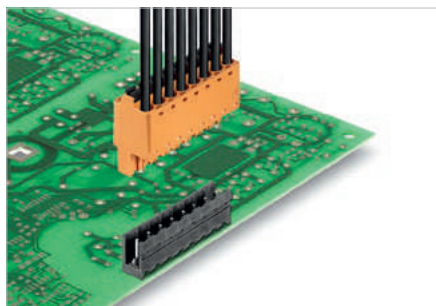

High-temperature-resistant, 180°-angled male header, optimised for SMT processing. The male headers can be manually coded or ordered as pre-coded headers.

- Available in open, closed (G) or with solder Flange (LF).
- The solder flange makes an additional screw-fixation to the PCB unnecessary and protects the solder joints against mechanical stress.
- Available with 1.5 mm or 3.2 mm solder pins.
- Packed either in box (BX) or an anti-static roll (tape-on-reel, RL)
- The 1.5 mm solder pin reduces the solder paste to a minimum without losing holding force to the PCB.

### Product data

IEC: 400 V / 27.5 A  
UL: 300 V / 18.5 A



For additional articles and information, refer to [catalog.weidmueller.com](http://catalog.weidmueller.com)

#### Note:

- Gold-plated contact surfaces on request
- Rated current related to rated cross-section & min. No. of poles.
- Diameter of solder eyelet  $D = 1.4 \pm 0.1$  mm
- Solder eyelet diameter  $D = 1.5 \pm 0.1$  mm, from 9 poles
- P on drawing = pitch
- Rated data refer only to the component itself. Clearance and creepage distances to other components are to be designed in accordance with the relevant application standards.

### SL-SMT 5.00HC../180 Box

#### Packaged in box



#### Dimensioned drawing

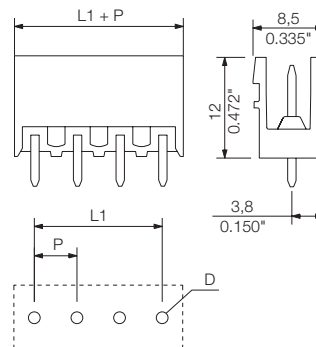

### Technical data

#### In compliance with IEC 60664-1 / IEC 61984

Clamping range, max.			
<b>Solid core H05(07) V-U</b>			
Stranded H07 V-R			
Flexible H05(07) V-K			
Flexible with ferrule			
Ferrule with plastic collar			
Stripping length			
Screwdriver blade	mm		
According to norm			
Tightening torque range			
<b>Rated current, max.</b>	<b>A</b>	<b>27.5</b>	<b>24</b>
At ambient temperature		20°C	40°C
For conductor cross-section		III	III II
Overtoltage category		3	2 2
Pollution severity		3	2 2
<b>Rated voltage</b>	<b>V</b>	<b>250</b>	<b>320 400</b>
Rated impulse voltage	kV	4	4 4
<b>UL / CUL (Use Group)</b>	<b>B C D</b>		
<b>Rated voltage</b>	<b>V</b>	<b>300</b>	<b>300</b>
<b>Rated current</b>	<b>A</b>	<b>18.5</b>	<b>10</b>
<b>AWG conductor</b>	<b>AWG</b>	-	
<b>CSA (Use Group)</b>	<b>B C D</b>		
Rated voltage	V	300	300
Rated current	A	15	15
AWG conductor	AWG	-	
<b>General data</b>			
Type of insulation material	LCP GF		
UL 94 flammability rating	V-0		
Contact base material	CuMg		
Material of contact surface	tinned		
Pin dimensions = d	mm	1.2, Octagonal	
Solder eyelet Ø = D	mm	1.4	
Solder eyelet Ø tolerance	mm	+ 0,1	

### Accessories

Note: Refer to the Accessories chapter for additional accessories.

Coding	Order No.
BLZ/SL KO OR BX	1573010000
BLZ/SL KO BK BX	1545710000
Partition element	
SL AT OR	1598300000
SL AT SW	1770240000

### Ordering data

Solder pin length		3.2 mm		
Colour		Black		
Pitch	5.00 mm			
Pol.	L1	(inch)	Qty.	Order No.
2	5.00	0.197	100	1840920000
3	10.00	0.394	100	1840930000
4	15.00	0.591	100	1840940000
5	20.00	0.787	50	1840950000
6	25.00	0.984	50	1840960000
7	30.00	1.181	50	1840970000
8	35.00	1.378	50	1840980000
9	40.00	1.575	50	1840990000
10	45.00	1.772	50	1841000000
11	50.00	1.969	50	1841020000
12	55.00	2.165	50	1841030000
13	60.00	2.362	50	1841040000
14	65.00	2.559	50	1841050000
15	70.00	2.756	50	1841060000
16	75.00	2.953	50	1841070000
17	80.00	3.150	20	1841080000
18	85.00	3.346	20	1841090000
19	90.00	3.543	20	1841100000
20	95.00	3.740	20	1841110000
21	100.00	3.937	20	1841120000
22	105.00	4.134	20	1841130000
23	110.00	4.331	20	1841140000
24	115.00	4.528	20	1841150000



### SL-SMT 5.00HC../180 Tape

Tape-on-reel



Dimensioned drawing

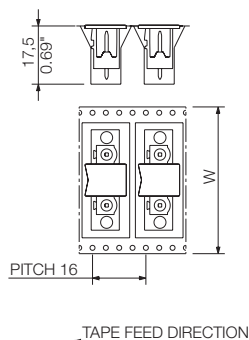

#### Ordering data

Solder pin length		1.5 mm	
Colour		Black	
Pitch		5.00 mm	
Pol.	L1 (inch)	Qty.	Order No.
2	5.00	250	1797800000
3	10.00	250	1797810000
4	15.00	250	1797820000
5	20.00	250	1797830000
6	25.00	250	1797840000
7	30.00	250	1797850000
8	35.00	250	1797860000

Tape widths: 32, 44, 56, 72, 88

### SL-SMT 5.00HC../180G Box

Packaged in box



Dimensioned drawing

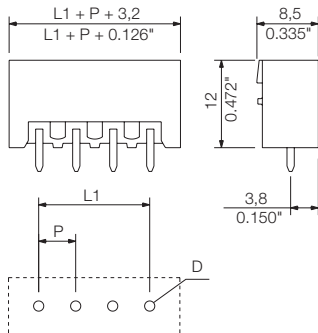

#### Ordering data

Solder pin length		3.2 mm	
Colour		Black	
Pitch		5.00 mm	
Pol.	L1 (inch)	Qty.	Order No.
2	5.00	100	1841160000
3	10.00	100	1841170000
4	15.00	100	1841180000
5	20.00	50	1841190000
6	25.00	50	1841200000
7	30.00	50	1841210000
8	35.00	50	1841220000
9	40.00	50	1841230000
10	45.00	50	1841240000
11	50.00	50	1841250000
12	55.00	50	1841260000
13	60.00	50	1841270000
14	65.00	50	1841280000
15	70.00	50	1841290000
16	75.00	50	1841300000
17	80.00	20	1841310000
18	85.00	20	1841320000
19	90.00	20	1841330000
20	95.00	20	1841340000
21	100.00	20	1841350000
22	105.00	20	1841360000
23	110.00	20	1841370000
24	115.00	20	1841380000

### SL-SMT 5.00HC../180G Tape

Tape-on-reel



Dimensioned drawing

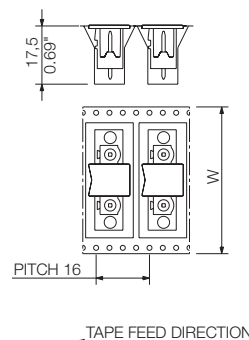

#### Ordering data

Solder pin length		1.5 mm	
Colour		Black	
Pitch		5.00 mm	
Pol.	L1 (inch)	Qty.	Order No.
2	5.00	250	1797870000
3	10.00	250	1797880000
4	15.00	250	1797890000
5	20.00	250	1797900000
6	25.00	250	1797910000
7	30.00	250	1797920000
8	35.00	205	1110720000

Tape widths: 32, 44, 56, 72, 88

G

## Connectors in 5.00 mm pitch Series BL/SL 5.00

### SL-SMT 5.00HC/./180

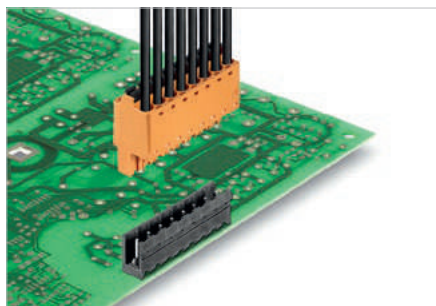

High-temperature-resistant, 180°-angled male header, optimised for SMT processing. The male headers can be manually coded or ordered as pre-coded headers.

- Available in open, closed (G) or with solder Flange (LF).
- The solder flange makes an additional screw-fixation to the PCB unnecessary and protects the solder joints against mechanical stress.
- Available with 1.5 mm or 3.2 mm solder pins.
- Packed either in box (BX) or an anti-static roll (tape-on-reel, RL)
- The 1.5 mm solder pin reduces the solder paste to a minimum without losing holding force to the PCB.

### Product data

IEC: 400 V / 27.5 A  
UL: 300 V / 18.5 A



For additional articles and information, refer to [catalog.weidmueller.com](http://catalog.weidmueller.com)

#### Note:

- Gold-plated contact surfaces on request
- Rated current related to rated cross-section & min. No. of poles.
- P on drawing = pitch
- Rated data refer only to the component itself. Clearance and creepage distances to other components are to be designed in accordance with the relevant application standards.

### SL-SMT 5.00HC/./180LF Box

Packaged in box; with solder flange



#### Dimensioned drawing

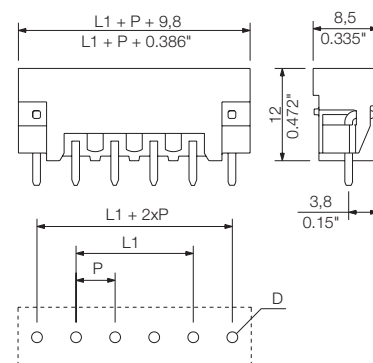

### Technical data

#### In compliance with IEC 60664-1 / IEC 61984

Clamping range, max.			
<b>Solid core H05(07) V-U</b>			
Stranded H07 V-R			
Flexible H05(07) V-K			
Flexible with ferrule			
Ferrule with plastic collar			
Stripping length			
Screwdriver blade	mm		
According to norm			
Tightening torque range			
<b>Rated current, max.</b>	<b>A</b>	<b>27.5</b>	<b>24</b>
At ambient temperature		20°C	40°C
For conductor cross-section			
Overtoltage category		III	III II
Pollution severity		3	2 2
<b>Rated voltage</b>	<b>V</b>	<b>250</b>	<b>320 400</b>
Rated impulse voltage	kV	4	4 4
<b>UL / CUL (Use Group)</b>	<b>B C D</b>		
<b>Rated voltage</b>	<b>V</b>	<b>300</b>	<b>300</b>
<b>Rated current</b>	<b>A</b>	<b>18.5</b>	<b>10</b>
<b>AWG conductor</b>	<b>AWG</b>	-	
<b>CSA (Use Group)</b>	<b>B C D</b>		
Rated voltage	V	300	300
Rated current	A	15	15
AWG conductor	AWG	-	
<b>General data</b>			
Type of insulation material	LCP GF		
UL 94 flammability rating	V-0		
Contact base material	CuMg		
Material of contact surface	tinned		
Pin dimensions = d	mm	1.2, Octagonal	
Solder eyelet Ø = D	mm	1.5	
Solder eyelet Ø tolerance	mm	+ 0,1	

### Accessories

Note: Refer to the Accessories chapter for additional accessories.

Coding	Order No.
BLZ/SL KO OR BX	<b>1573010000</b>
BLZ/SL KO BK BX	<b>1545710000</b>
Partition element	
SL AT OR	<b>1598300000</b>
SL AT SW	<b>1770240000</b>

### Ordering data

Solder pin length		3.2 mm		
Colour		Black		
Pitch	5.00 mm			
Pol.	L1	(inch)	Qty.	Order No.
2	5.00	0.197	90	<b>1841390000</b>
3	10.00	0.394	72	<b>1841400000</b>
4	15.00	0.591	60	<b>1841410000</b>
5	20.00	0.787	54	<b>1841420000</b>
6	25.00	0.984	42	<b>1841430000</b>
7	30.00	1.181	42	<b>1841440000</b>
8	35.00	1.378	36	<b>1841450000</b>
9	40.00	1.575	30	<b>1841460000</b>
10	45.00	1.772	30	<b>1841470000</b>
11	50.00	1.969	24	<b>1841480000</b>
12	55.00	2.165	24	<b>1841490000</b>
13	60.00	2.362	24	<b>1841500000</b>
14	65.00	2.559	18	<b>1841510000</b>
15	70.00	2.756	18	<b>1841520000</b>
16	75.00	2.953	18	<b>1841530000</b>
17	80.00	3.150	18	<b>1841540000</b>
18	85.00	3.346	18	<b>1841550000</b>
19	90.00	3.543	12	<b>1841560000</b>
20	95.00	3.740	12	<b>1841570000</b>
21	100.00	3.937	12	<b>1841580000</b>
22	105.00	4.134	12	<b>1841590000</b>
23	110.00	4.331	12	<b>1841600000</b>
24	115.00	4.528	12	<b>1841610000</b>

## SL-SMT 5.00HC/./180LF Tape

Tape-on-reel; with solder flange



Dimensioned drawing

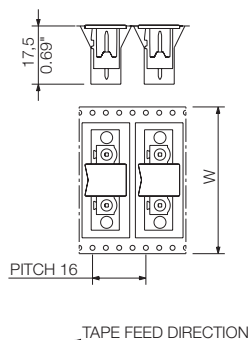

## Solder flange (LF)

Normally you use a pin header with fastening flanges (F) in combination with a screw from the rear side of the PCB to increase the fixation forces of the pin headers. The disadvantages are additional process steps that make the PCB mounting complex and cost intensive. The patented solder flange was designed to solve exactly this problem and find a simple and cheap solution. The additional solder pins substitute the present screw flanges and they get soldered together with the pin header. This terminates additional process steps and thus reduces production costs. The additional fixation protects the soldered connections from tensile strain and avoids permanent mechanical stress such as caused by the post-fastened screw forces.

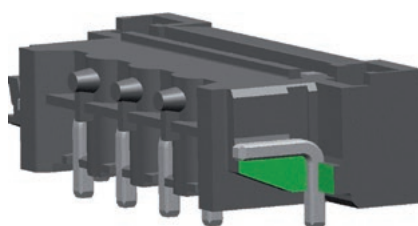

## Ordering data

Solder pin length		1.5 mm	
Colour		Black	
Pitch		5.00 mm	
Pol.	L1	(inch)	Qty. Order No.
2	5.00	0.197	250 1797930000
3	10.00	0.394	250 1797940000
4	15.00	0.591	250 1797950000
5	20.00	0.787	250 1797960000
6	25.00	0.984	250 1797970000

Tape widths: 32, 44, 56, 72, 88

## Connectors in 5.00 mm pitch Series BL/SL 5.00

### SLDV-THR 5.00/./180

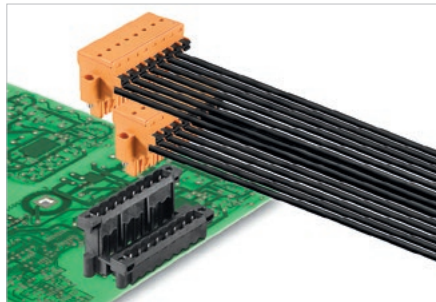

Double-level, 180° male header, optimised for the SMT process. The connection levels are offset and designed for a female plug with screw connection or PUSH IN wire connect. The male headers can be manually coded or ordered as pre-coded headers.

- Available in closed (G), with solder flange (GLF), screw flange (F) or screw & solder flange (FLF).
- The solder flange makes an additional screw-fixation to the PCB unnecessary and protects the solder joints against mechanical stress.
- Available with 1.5 mm or 3.2 mm solder pins.
- The 1.5 mm solder pin reduces the solder paste to a minimum without losing holding force to the PCB.
- The FLF version is featured with a soldering flange and an additional screw-fastening possibility to the PCB.

### Technical data

#### In compliance with IEC 60664-1 / IEC 61984

Clamping range, max.			
<b>Solid core H05(07) V-U</b>			
Stranded H07 V-R			
Flexible H05(07) V-K			
Flexible with ferrule			
Ferrule with plastic collar			
Stripping length			
Screwdriver blade	mm		
According to norm			
Tightening torque range			
<b>Rated current, max.</b>	<b>A</b>	<b>15</b>	<b>13</b>
At ambient temperature		20°C	40°C
For conductor cross-section		III	III II
Overtoltage category		3	2 2
Pollution severity		3	2 2
<b>Rated voltage</b>	<b>V</b>	<b>250</b>	<b>320 400</b>
Rated impulse voltage	kV	4	4 4
<b>UL / CUL (Use Group)</b>		<b>B</b>	<b>C D</b>
<b>Rated voltage</b>	<b>V</b>	<b>300</b>	<b>300</b>
<b>Rated current</b>	<b>A</b>	<b>10</b>	<b>10</b>
<b>AWG conductor</b>	<b>AWG</b>		-
<b>CSA (Use Group)</b>		<b>B</b>	<b>C D</b>
Rated voltage	V	300	300
Rated current	A	10	10
AWG conductor	AWG		-
<b>General data</b>			
Type of insulation material		LCP GF	
UL 94 flammability rating		V-0	
Contact base material		CuSn	
Material of contact surface		tinned	
Pin dimensions = d	mm	1.2, Octagonal	
Solder eyelet Ø = D	mm	1.5	
Solder eyelet Ø tolerance	mm	+ 0,1	

### Product data

IEC: 400 V / 15 A  
UL: 300 V / 10 A



For additional articles and information, refer to [catalog.weidmuller.com](http://catalog.weidmuller.com)

#### Note:

- Rated current related to rated cross-section & min. No. of poles.
- Spacing between rows: see hole layout
- P on drawing = pitch
- Rated data refer only to the component itself. Clearance and creepage distances to other components are to be designed in accordance with the relevant application standards.

### SLDV-THR 5.00/./180G

without solder flange



#### Dimensioned drawing

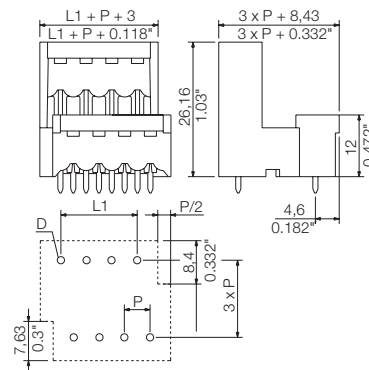

### Ordering data

Solder pin length		3.2 mm		
Colour		Black		
Pitch	5.00 mm			
Pol.	L1	(inch)	Qty.	Order No.
4	5.00	0.197	50	1882690000
6	10.00	0.394	50	1882700000
8	15.00	0.591	50	1882370000
10	20.00	0.787	50	1882710000
12	25.00	0.984	50	1882720000
14	30.00	1.181	20	1882730000
16	35.00	1.378	20	1862380000
18	40.00	1.575	20	1882740000
20	45.00	1.772	20	1862390000
22	50.00	1.969	10	1882750000
24	55.00	2.165	10	1882760000
26	60.00	2.362	10	1882770000
28	65.00	2.559	10	1882780000
30	70.00	2.756	10	1882790000
32	75.00	2.953	10	1882800000
34	80.00	3.150	10	1882810000
36	85.00	3.346	10	1882820000
38	90.00	3.543	10	1882830000
40	95.00	3.740	10	1862400000
42	100.00	3.937	10	1882840000
44	105.00	4.134	10	1882850000
46	110.00	4.331	10	1882860000
48	115.00	4.528	10	1882870000

### Accessories

Note: Refer to the Accessories chapter for additional accessories.

Coding	Order No.
BLZ/SL KO OR BX	1573010000
BLZ/SL KO BK BX	1545710000
Partition element	Order No.
SL AT OR	1598300000
SL AT SW	1770240000

**SLDV-THR 5.00../180GLF**

with solder flange



Dimensioned drawing

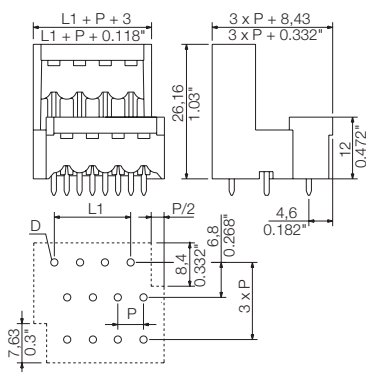

**Ordering data**

Solder pin length		3.2 mm			
Colour		Black			
Pitch		5.00 mm			
Pol.	L1	(inch)	Qty.	Order No.	
4	5.00	0.197	50	1911290000	
6	10.00	0.394	50	1911310000	
8	15.00	0.591	50	1911320000	
10	20.00	0.787	50	1911330000	
12	25.00	0.984	50	1911340000	
14	30.00	1.181	20	1911350000	
16	35.00	1.378	20	1911360000	
18	40.00	1.575	20	1911370000	
20	45.00	1.772	20	1911410000	
22	50.00	1.969	10	1911470000	
24	55.00	2.165	10	1911500000	
26	60.00	2.362	10	1911520000	
28	65.00	2.559	10	1911550000	
30	70.00	2.756	10	1911640000	
32	75.00	2.953	10	1911650000	
34	80.00	3.150	10	1911660000	
36	85.00	3.346	10	1911670000	
38	90.00	3.543	10	1911680000	
40	95.00	3.740	10	1911690000	
42	100.00	3.937	10	1911710000	
44	105.00	4.134	10	1911720000	
46	110.00	4.331	10	1911730000	
48	115.00	4.528	10	1911740000	

**SLDV-THR 5.00../180F**

without solder flange



Dimensioned drawing

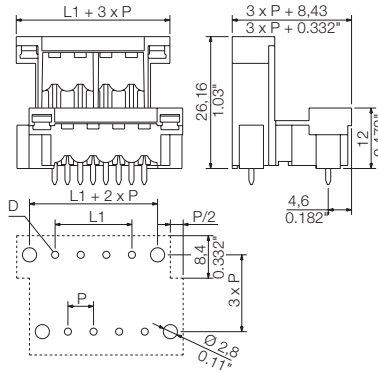

**Ordering data**

Solder pin length		3.2 mm			
Colour		Black			
Pitch		5.00 mm			
Pol.	L1	(inch)	Qty.	Order No.	
4	5.00	0.197	50	1882930000	
6	10.00	0.394	50	1882940000	
8	15.00	0.591	50	1882950000	
10	20.00	0.787	50	1882960000	
12	25.00	0.984	50	1882970000	
14	30.00	1.181	20	1882980000	
16	35.00	1.378	20	1882990000	
18	40.00	1.575	20	1883000000	
20	45.00	1.772	20	1881340000	
22	50.00	1.969	10	1883010000	
24	55.00	2.165	10	1881370000	
26	60.00	2.362	10	1883020000	
28	65.00	2.559	10	1881390000	
30	70.00	2.756	10	1883030000	
32	75.00	2.953	10	1881400000	
34	80.00	3.150	10	1881420000	
36	85.00	3.346	10	1881470000	
38	90.00	3.543	10	1883040000	
40	95.00	3.740	10	1881490000	
42	100.00	3.937	10	1883050000	
44	105.00	4.134	10	1883060000	
46	110.00	4.331	10	1883070000	
48	115.00	4.528	10	1883080000	

**SLDV-THR 5.00../180FLF**

with solder flange



Dimensioned drawing

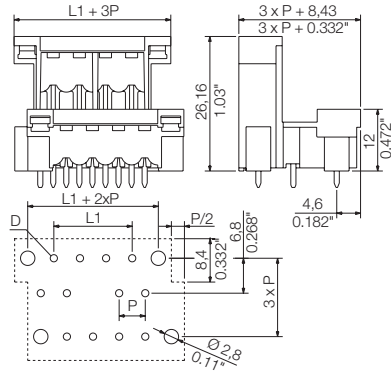

**Ordering data**

Solder pin length		3.2 mm			
Colour		Black			
Pitch		5.00 mm			
Pol.	L1	(inch)	Qty.	Order No.	
4	5.00	0.197	50	1883100000	
6	10.00	0.394	50	1883110000	
8	15.00	0.591	50	1883120000	
10	20.00	0.787	50	1883130000	
12	25.00	0.984	50	1883140000	
14	30.00	1.181	20	1883150000	
16	35.00	1.378	20	1883160000	
18	40.00	1.575	20	1883170000	
20	45.00	1.772	20	1883180000	
22	50.00	1.969	10	1883190000	
24	55.00	2.165	10	1883200000	
26	60.00	2.362	10	1883230000	
28	65.00	2.559	10	1883240000	
30	70.00	2.756	10	1883250000	
32	75.00	2.953	10	1883270000	
34	80.00	3.150	10	1883280000	
36	85.00	3.346	10	1883290000	
38	90.00	3.543	10	1883300000	
40	95.00	3.740	10	1883310000	
42	100.00	3.937	10	1883320000	
44	105.00	4.134	10	1883330000	
46	110.00	4.331	10	1883340000	
48	115.00	4.528	10	1883350000	

## Connectors in 5.00 mm pitch Series BL/SL 5.00

### SL 5.00/./90

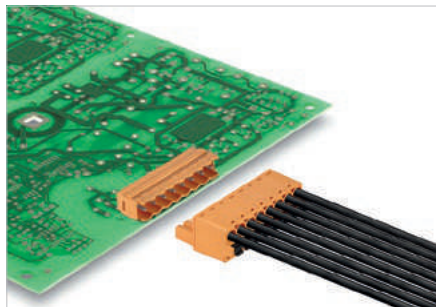

Male headers with 90° orientation, optimised for wave soldering. Available in versions with either open or closed ends (B). Mounting blocks can be attached into the closed variants. The blocks can be used to screw on to the female plug of the circuit board. The male headers can be manually coded or ordered as pre-coded headers.

### Technical data

#### In compliance with IEC 60664-1 / IEC 61984

Clamping range, max.			
<b>Solid core H05(07) V-U</b>			
Stranded H07 V-R			
Flexible H05(07) V-K			
Flexible with ferrule			
Ferrule with plastic collar			
Stripping length			
Screwdriver blade	mm		
According to norm			
Tightening torque range			
<b>Rated current, max.</b>	<b>A</b>	<b>18</b>	<b>15</b>
At ambient temperature		20°C	40°C
For conductor cross-section		III	III II
Overvoltage category		III	III II
Pollution severity		3	2 2
<b>Rated voltage</b>	<b>V</b>	<b>250</b>	<b>320 400</b>
Rated impulse voltage	kV	4	4 4
<b>UL / CUL (Use Group)</b>	<b>B C D</b>		
<b>Rated voltage</b>	<b>V</b>	<b>300</b>	<b>300</b>
<b>Rated current</b>	<b>A</b>	<b>15</b>	<b>10</b>
<b>AWG conductor</b>	<b>AWG</b>		
<b>CSA (Use Group)</b>	<b>B C D</b>		
Rated voltage	V	300	300
Rated current	A	15	10
AWG conductor	AWG		
<b>General data</b>			
Type of insulation material		PBT	
UL 94 flammability rating		V-0	
Contact base material		CuSn	
Material of contact surface		tinned	
Pin dimensions = d	mm	1.2, Octagonal	
Solder eyelet Ø = D	mm	1.3	
Solder eyelet Ø tolerance	mm	+ 0,1	

### Product data

IEC: 400 V / 18 A  
UL: 300 V / 15 A



For additional articles and information, refer to [catalog.weidmuller.com](http://catalog.weidmuller.com)

#### Note:

- Additional colours on request
- Gold-plated contact surfaces on request
- Rated current related to rated cross-section & min. No. of poles.
- P on drawing = pitch
- Rated data refer only to the component itself. Clearance and creepage distances to other components are to be designed in accordance with the relevant application standards.

### SL 5.00/./90



#### Dimensioned drawing

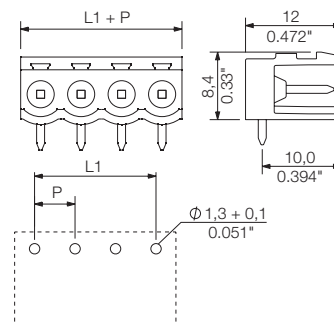

### Accessories

Note: Refer to the Accessories chapter for additional accessories.

Coding	Order No.
BLZ/SL KO OR BX	<b>1573010000</b>
BLZ/SL KO BK BX	<b>1545710000</b>
<b>Partition element</b>	
SL AT OR	<b>1598300000</b>
SL AT SW	<b>1770240000</b>
<b>LED light guide</b>	
SL FLA 1.5/1	<b>1580100000</b>
SL FLA 2,3/1	<b>1636670000</b>
SL FLA 2,3/24	<b>1636680000</b>
SL FLA 3.8/1	<b>1580110000</b>
SL FLA 9.0/1	<b>1580120000</b>
<b>Mounting block</b>	
SLA BB11R OR	<b>1604120000</b>
SLA BB11R SW	<b>1692340000</b>

### Ordering data

Solder pin length		3.2 mm		
Colour		Orange		
Pitch	5.00 mm			
Pol.	L1	(inch)	Qty.	Order No.
2	5.00	0.197	100	<b>1571130000</b>
3	10.00	0.394	100	<b>1571140000</b>
4	15.00	0.591	100	<b>1571150000</b>
5	20.00	0.787	50	<b>1571160000</b>
6	25.00	0.984	50	<b>1571170000</b>
7	30.00	1.181	50	<b>1571180000</b>
8	35.00	1.378	50	<b>1571190000</b>
9	40.00	1.575	50	<b>1571200000</b>
10	45.00	1.772	50	<b>1571210000</b>
11	50.00	1.969	50	<b>1571220000</b>
12	55.00	2.165	50	<b>1571110000</b>
13	60.00	2.362	50	<b>1571230000</b>
14	65.00	2.559	50	<b>1571240000</b>
15	70.00	2.756	50	<b>1571250000</b>
16	75.00	2.953	50	<b>1571260000</b>
17	80.00	3.150	20	<b>1571270000</b>
18	85.00	3.346	20	<b>1571280000</b>
19	90.00	3.543	20	<b>1571290000</b>
20	95.00	3.740	20	<b>1571300000</b>
21	100.00	3.937	20	<b>1571310000</b>
22	105.00	4.134	20	<b>1571320000</b>
23	110.00	4.331	20	<b>1571330000</b>
24	115.00	4.528	20	<b>1571340000</b>

SL 5.00/..90B



Dimensioned drawing

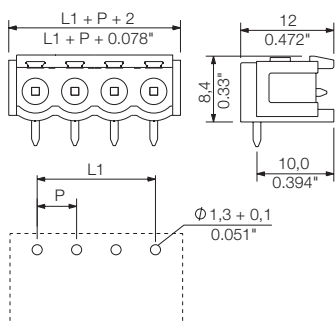

Ordering data

Solder pin length		3.2 mm		
Colour		Orange		
Pitch		5.00 mm		
Pol.	L1	(inch)	Qty.	Order No.
2	5.00	0.197	100	1580860000
3	10.00	0.394	100	1580870000
4	15.00	0.591	100	1580880000
5	20.00	0.787	50	1580890000
6	25.00	0.984	50	1580900000
7	30.00	1.181	50	1580910000
8	35.00	1.378	50	1580920000
9	40.00	1.575	50	1580930000
10	45.00	1.772	50	1580940000
11	50.00	1.969	50	1580950000
12	55.00	2.165	50	1580960000
13	60.00	2.362	50	1580970000
14	65.00	2.559	50	1580980000
15	70.00	2.756	50	1580990000
16	75.00	2.953	50	1581000000
17	80.00	3.150	20	1581010000
18	85.00	3.346	20	1581020000
19	90.00	3.543	20	1581030000
20	95.00	3.740	20	1581040000
21	100.00	3.937	20	1581050000
22	105.00	4.134	20	1581060000
23	110.00	4.331	20	1581070000
24	115.00	4.528	20	1581080000



## Connectors in 5.00 mm pitch Series BL/SL 5.00

### SL 5.00/./180

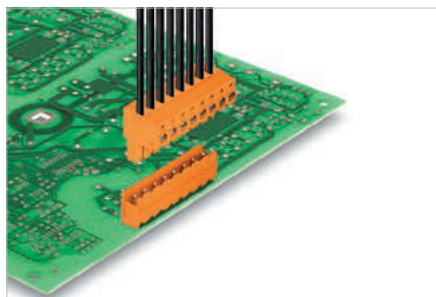

Male headers with 180° wire outlet, optimised for wave soldering. Available in versions with either open or closed ends (B). Mounting blocks can be attached onto the closed variants. The blocks can be used to screw on to the female plug of the circuit board. The male headers can be manually coded or ordered as pre-coded headers.

### Product data

IEC: 400 V / 18 A  
UL: 300 V / 15 A



For additional articles and information, refer to [catalog.weidmuller.com](http://catalog.weidmuller.com)

#### Note:

- Additional colours on request
- Gold-plated contact surfaces on request
- Rated current related to rated cross-section & min. No. of poles.
- P on drawing = pitch
- Rated data refer only to the component itself. Clearance and creepage distances to other components are to be designed in accordance with the relevant application standards.

### SL 5.00/./180



#### Dimensioned drawing

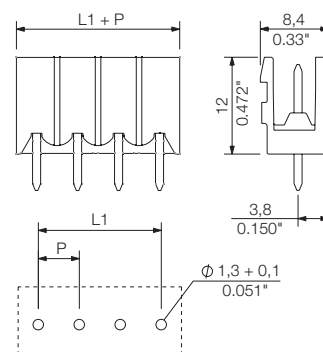

### Technical data

#### In compliance with IEC 60664-1 / IEC 61984

Clamping range, max.			
<b>Solid core H05(07) V-U</b>			
Stranded H07 V-R			
Flexible H05(07) V-K			
Flexible with ferrule			
Ferrule with plastic collar			
Stripping length			
Screwdriver blade	mm		
According to norm			
Tightening torque range			
<b>Rated current, max.</b>	<b>A</b>	<b>18</b>	<b>15</b>
At ambient temperature		20°C	40°C
For conductor cross-section			
Overvoltage category		III	III II
Pollution severity		3	2 2
<b>Rated voltage</b>	<b>V</b>	<b>250</b>	<b>320 400</b>
Rated impulse voltage	kV	4	4 4
<b>UL / CUL (Use Group)</b>		<b>B</b>	<b>C D</b>
<b>Rated voltage</b>	<b>V</b>	<b>300</b>	<b>300</b>
<b>Rated current</b>	<b>A</b>	<b>15</b>	<b>10</b>
<b>AWG conductor</b>	<b>AWG</b>		-
<b>CSA (Use Group)</b>		<b>B</b>	<b>C D</b>
Rated voltage	V	300	300
Rated current	A	15	10
AWG conductor	AWG		-
<b>General data</b>			
Type of insulation material		PBT	
UL 94 flammability rating		V-0	
Contact base material		CuSn	
Material of contact surface		tinned	
Pin dimensions = d	mm	1.2, Octagonal	
Solder eyelet Ø = D	mm	1.3	
Solder eyelet Ø tolerance	mm	+ 0,1	

### Accessories

Note: Refer to the Accessories chapter for additional accessories.

Coding	Order No.
BLZ/SL KO OR BX	<b>1573010000</b>
BLZ/SL KO BK BX	<b>1545710000</b>
<b>Partition element</b>	
SL AT OR	<b>1598300000</b>
SL AT SW	<b>1770240000</b>
<b>Mounting block</b>	
SLA BB11R OR	<b>1604120000</b>
SLA BB11R SW	<b>1692340000</b>

### Ordering data

Solder pin length		3.2 mm		
Colour		Orange		
Pitch	5.00 mm			
Pol.	L1	(inch)	Qty.	Order No.
2	5.00	0.197	100	<b>1581320000</b>
3	10.00	0.394	100	<b>1581330000</b>
4	15.00	0.591	100	<b>1581340000</b>
5	20.00	0.787	50	<b>1581350000</b>
6	25.00	0.984	50	<b>1581360000</b>
7	30.00	1.181	50	<b>1581370000</b>
8	35.00	1.378	50	<b>1581380000</b>
9	40.00	1.575	50	<b>1581390000</b>
10	45.00	1.772	50	<b>1581400000</b>
11	50.00	1.969	50	<b>1581410000</b>
12	55.00	2.165	50	<b>1581420000</b>
13	60.00	2.362	50	<b>1581430000</b>
14	65.00	2.559	50	<b>1581440000</b>
15	70.00	2.756	50	<b>1581450000</b>
16	75.00	2.953	50	<b>1581460000</b>
17	80.00	3.150	20	<b>1581470000</b>
18	85.00	3.346	20	<b>1581480000</b>
19	90.00	3.543	20	<b>1581490000</b>
20	95.00	3.740	20	<b>1581500000</b>
21	100.00	3.937	20	<b>1581510000</b>
22	105.00	4.134	20	<b>1581520000</b>
23	110.00	4.331	20	<b>1581530000</b>
24	115.00	4.528	20	<b>1581540000</b>



SL 5.00/./180B



Dimensioned drawing

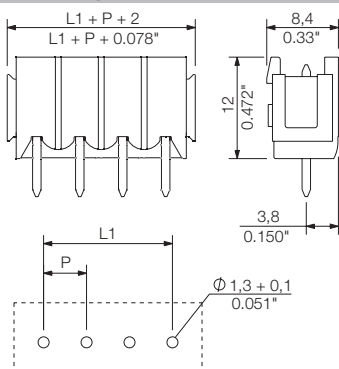

Ordering data

Solder pin length		3.2 mm		
Colour		Orange		
Pitch		5.00 mm		
Pol.	L1	(inch)	Qty.	Order No.
2	5.00	0.197	100	1581780000
3	10.00	0.394	100	1581790000
4	15.00	0.591	100	1581800000
5	20.00	0.787	50	1581810000
6	25.00	0.984	50	1581820000
7	30.00	1.181	50	1581830000
8	35.00	1.378	50	1581840000
9	40.00	1.575	50	1581850000
10	45.00	1.772	50	1581860000
11	50.00	1.969	50	1581870000
12	55.00	2.165	50	1581880000
13	60.00	2.362	50	1581890000
14	65.00	2.559	50	1581900000
15	70.00	2.756	50	1581910000
16	75.00	2.953	50	1581920000
17	80.00	3.150	20	1581930000
18	85.00	3.346	20	1581940000
19	90.00	3.543	20	1581950000
20	95.00	3.740	20	1581960000
21	100.00	3.937	20	1581970000
22	105.00	4.134	20	1581980000
23	110.00	4.331	20	1581990000
24	115.00	4.528	20	1582000000



## Connectors in 5.00 mm pitch Series BL/SL 5.00

### SL 5.00../135

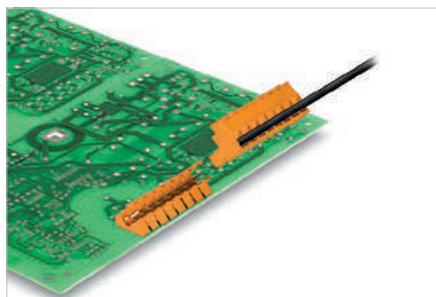

Male headers with 135° wire outlet, optimised for wave soldering. Available in versions with either open or closed ends (B). Mounting blocks can be attached onto the closed variants. The blocks can be used to screw on to the female plug of the circuit board. The male headers can be manually coded or ordered as pre-coded headers.

### Product data

IEC: 400 V / 17 A  
UL: 300 V / 15 A



For additional articles and information, refer to [catalog.weidmueller.com](http://catalog.weidmueller.com)

#### Note:

- Additional colours on request
- Gold-plated contact surfaces on request
- Rated current related to rated cross-section & min. No. of poles.
- P on drawing = pitch
- Rated data refer only to the component itself. Clearance and creepage distances to other components are to be designed in accordance with the relevant application standards.

### SL 5.00../135



#### Dimensioned drawing

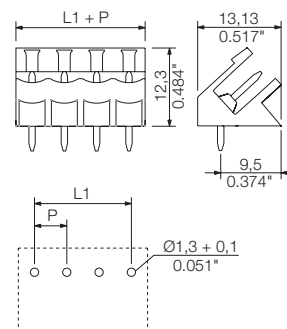

### Technical data

#### In compliance with IEC 60664-1 / IEC 61984

Clamping range, max.			
<b>Solid core H05(07) V-U</b>			
Stranded H07 V-R			
Flexible H05(07) V-K			
Flexible with ferrule			
Ferrule with plastic collar			
Stripping length			
Screwdriver blade	mm		
According to norm			
Tightening torque range			
<b>Rated current, max.</b>	<b>A</b>	<b>17</b>	<b>15</b>
At ambient temperature		20°C	40°C
For conductor cross-section			
Overvoltage category		III	III II
Pollution severity		3	2 2
<b>Rated voltage</b>	<b>V</b>	<b>250</b>	<b>320 400</b>
Rated impulse voltage	kV	4	4 4
<b>UL / CUL (Use Group)</b>		<b>B</b>	<b>C D</b>
<b>Rated voltage</b>	<b>V</b>	<b>300</b>	<b>300</b>
<b>Rated current</b>	<b>A</b>	<b>15</b>	<b>10</b>
<b>AWG conductor</b>	<b>AWG</b>		-
<b>CSA (Use Group)</b>		<b>B</b>	<b>C D</b>
Rated voltage	V	300	300
Rated current	A	15	10
AWG conductor	AWG		-
<b>General data</b>			
Type of insulation material		PBT	
UL 94 flammability rating		V-0	
Contact base material		CuSn	
Material of contact surface		tinned	
Pin dimensions = d	mm	1.2, Octagonal	
Solder eyelet Ø = D	mm	1.3	
Solder eyelet Ø tolerance	mm	+ 0,1	

### Accessories

Note: Refer to the Accessories chapter for additional accessories.

Coding	Order No.
BLZ/SL KO OR BX	<b>1573010000</b>
BLZ/SL KO BK BX	<b>1545710000</b>
<b>Partition element</b>	
SL AT OR	<b>1598300000</b>
SL AT SW	<b>1770240000</b>
<b>Mounting block</b>	
SL 135 BB15R OR	<b>1606450000</b>
SL 135 BB15R SW	<b>1636370000</b>

### Ordering data

Solder pin length		3.2 mm		
Colour		Orange		
Pitch	5.00 mm			
Pol.	L1	(inch)	Qty.	Order No.
2	5.00	0.197	100	<b>1630250000</b>
3	10.00	0.394	100	<b>1630260000</b>
4	15.00	0.591	100	<b>1630270000</b>
5	20.00	0.787	50	<b>1630280000</b>
6	25.00	0.984	50	<b>1630290000</b>
7	30.00	1.181	50	<b>1630300000</b>
8	35.00	1.378	50	<b>1630310000</b>
9	40.00	1.575	50	<b>1630320000</b>
10	45.00	1.772	50	<b>1630330000</b>
11	50.00	1.969	50	<b>1630340000</b>
12	55.00	2.165	50	<b>1630350000</b>
13	60.00	2.362	50	<b>1630360000</b>
14	65.00	2.559	50	<b>1630370000</b>
15	70.00	2.756	50	<b>1630380000</b>
16	75.00	2.953	50	<b>1630390000</b>
17	80.00	3.150	20	<b>1630400000</b>
18	85.00	3.346	20	<b>1630410000</b>
19	90.00	3.543	20	<b>1630420000</b>
20	95.00	3.740	20	<b>1630430000</b>
21	100.00	3.937	20	<b>1630440000</b>
22	105.00	4.134	20	<b>1630450000</b>
23	110.00	4.331	20	<b>1630460000</b>
24	115.00	4.528	20	<b>1630470000</b>

SL 5.00/..../135B



Dimensioned drawing

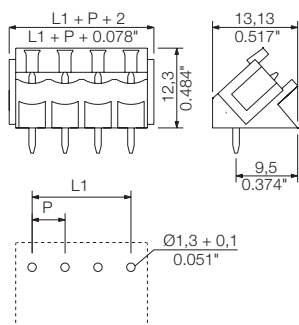

Ordering data

Solder pin length		3.2 mm		
Colour		Orange		
Pitch		5.00 mm		
Pol.	L1	(inch)	Qty.	Order No.
2	5.00	0.197	100	1630480000
3	10.00	0.394	100	1630490000
4	15.00	0.591	100	1630500000
5	20.00	0.787	50	1630510000
6	25.00	0.984	50	1630520000
7	30.00	1.181	50	1630530000
8	35.00	1.378	50	1630540000
9	40.00	1.575	50	1630550000
10	45.00	1.772	50	1630560000
11	50.00	1.969	50	1630570000
12	55.00	2.165	50	1630580000
13	60.00	2.362	50	1630590000
14	65.00	2.559	50	1630600000
15	70.00	2.756	50	1630610000
16	75.00	2.953	50	1630620000
17	80.00	3.150	20	1630630000
18	85.00	3.346	20	1630640000
19	90.00	3.543	20	1630650000
20	95.00	3.740	20	1630660000
21	100.00	3.937	20	1630670000
22	105.00	4.134	20	1630680000
23	110.00	4.331	20	1630690000
24	115.00	4.528	20	1630700000



## Connectors in 5.00 mm pitch Series BL/SL 5.00

### SLD 5.00/./90 & 180

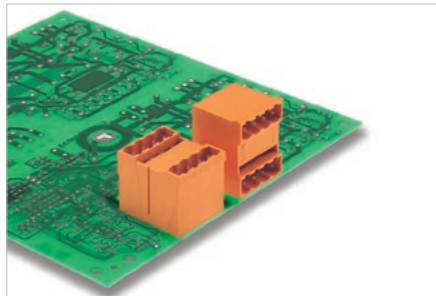

Double-level male header optimised for wave soldering. The connections are at the same level – with access that is flush over the front board. The male headers can be manually coded or ordered as pre-coded headers.

### Product data

IEC: 400 V / 11 A  
UL: 300 V / 10 A



For additional articles and information, refer to [catalog.weidmuller.com](http://catalog.weidmuller.com)

#### Note:

- Additional colours on request
- Rated current related to rated cross-section & min. No. of poles.
- Spacing between rows: see hole layout
- P on drawing = pitch
- Rated data refer only to the component itself. Clearance and creepage distances to other components are to be designed in accordance with the relevant application standards.

### SLD 5.00/./90G



#### Dimensioned drawing

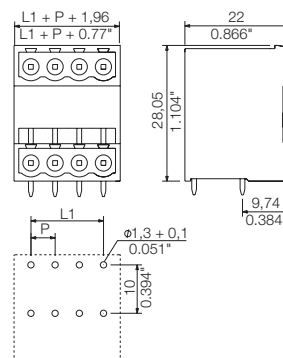

### Ordering data

Solder pin length		3.2 mm		
Colour		Orange		
Pitch	5.00 mm			
Pol.	L1	(inch)	Qty.	Order No.
4	5.00	0.197	50	1614350000
6	10.00	0.394	50	1614360000
8	15.00	0.591	50	1614370000
10	20.00	0.787	50	1614380000
12	25.00	0.984	50	1614390000
14	30.00	1.181	20	1614400000
16	35.00	1.378	20	1614410000
18	40.00	1.575	20	1614420000
20	45.00	1.772	20	1614430000
22	50.00	1.969	10	1614440000
24	55.00	2.165	10	1614450000
26	60.00	2.362	10	1614460000
28	65.00	2.559	10	1614470000
30	70.00	2.756	10	1614480000
32	75.00	2.953	10	1614490000
34	80.00	3.150	10	1614500000
36	85.00	3.346	10	1614510000
38	90.00	3.543	10	1614520000
40	95.00	3.740	10	1614530000
42	100.00	3.937	10	1614540000
44	105.00	4.134	10	1614550000
46	110.00	4.331	10	1614560000
48	115.00	4.528	10	1614570000

### Technical data

#### In compliance with IEC 60664-1 / IEC 61984

Clamping range, max.				
<b>Solid core H05(07) V-U</b>				
Stranded H07 V-R				
Flexible H05(07) V-K				
Flexible with ferrule				
Ferrule with plastic collar				
Stripping length				
Screwdriver blade	mm			
According to norm				
Tightening torque range				
<b>Rated current, max.</b>	<b>A</b>	<b>11</b>	<b>9.5</b>	
At ambient temperature		20°C	40°C	
For conductor cross-section				
Overtoltage category		III	III	II
Pollution severity		3	2	2
<b>Rated voltage</b>	<b>V</b>	<b>250</b>	<b>320</b>	<b>400</b>
Rated impulse voltage	kV	4	4	4
<b>UL / CUL (Use Group)</b>	<b>B</b>	<b>C</b>	<b>D</b>	
<b>Rated voltage</b>	<b>V</b>	<b>300</b>	<b>300</b>	
<b>Rated current</b>	<b>A</b>	<b>10</b>	<b>10</b>	
<b>AWG conductor</b>	<b>AWG</b>			
<b>CSA (Use Group)</b>	<b>B</b>	<b>C</b>	<b>D</b>	
Rated voltage	V	300	300	
Rated current	A	10	10	
AWG conductor	AWG			
<b>General data</b>				
Type of insulation material		PBT		
UL 94 flammability rating		V-0		
Contact base material		CuSn		
Material of contact surface		tinned		
Pin dimensions = d	mm	1.2, Octagonal		
Solder eyelet Ø = D	mm	1.3		
Solder eyelet Ø tolerance	mm	+ 0,1		

### Accessories

Note: Refer to the Accessories chapter for additional accessories.

Coding	Order No.
BLZ/SL KO OR BX	1573010000
BLZ/SL KO BK BX	1545710000
Partition element	
SL AT OR	1598300000
SL AT SW	1770240000

SLD 5.00/./180G



Dimensioned drawing

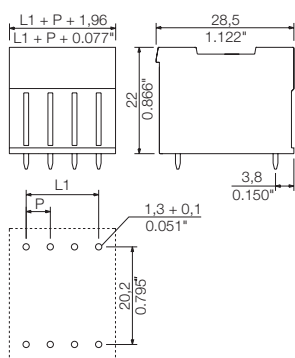

Ordering data

Solder pin length		3.2 mm		
Colour		Orange		
Pitch		5.00 mm		
Pol.	L1	(inch)	Qty.	Order No.
4	5.00	0.197	50	1614810000
6	10.00	0.394	50	1614820000
8	15.00	0.591	50	1614830000
10	20.00	0.787	50	1614840000
12	25.00	0.984	50	1614850000
14	30.00	1.181	20	1614860000
16	35.00	1.378	20	1614870000
18	40.00	1.575	20	1614880000
20	45.00	1.772	20	1614890000
22	50.00	1.969	10	1614900000
24	55.00	2.165	10	1614910000
26	60.00	2.362	10	1614920000
28	65.00	2.559	10	1614930000
30	70.00	2.756	10	1614940000
32	75.00	2.953	10	1614950000
34	80.00	3.150	10	1614960000
36	85.00	3.346	10	1614970000
38	90.00	3.543	10	1614980000
40	95.00	3.740	10	1614990000
42	100.00	3.937	10	1615000000
44	105.00	4.134	10	1615010000
46	110.00	4.331	10	1615020000
48	115.00	4.528	10	1615030000



## Connectors in 5.00 mm pitch Series BL/SL 5.00

### BLZP 5.00HC../180



The BLZP is the functional extension of the BLZ series. The "P" in the part name stands for a plus in security and performance in processing and use.

- WIRE READY - delivered with terminal points already opened
- Power tools can be used with the globally compatible plus/minus screw head
- Folded steel clamping yoke accommodates the connected wire and compensates for temperature fluctuations
- The integrated wire guard prevents dangerous under-insertion of the wire from occurring.
- Lock and release-lever: tool-less locking and gentle releasing of the connector reduces the mechanical stress on the solder joints.

### Product data

IEC: 400 V / 23 A / 0.2 - 4 mm<sup>2</sup>  
UL: 300 V / 20 A / AWG 26 - 12



For additional articles and information, refer to [catalog.weidmueller.com](http://catalog.weidmueller.com)

#### Note:

- Additional colours on request
- Gold-plated contact surfaces on request
- Rated current related to rated cross-section & min. No. of poles.
- Wire end ferrule without plastic collar to DIN 46228/1
- Wire end ferrule with plastic collar to DIN 46228/4
- P on drawing = pitch
- Rated data refer only to the component itself. Clearance and creepage distances to other components are to be designed in accordance with the relevant application standards.

### BLZP 5.00HC../180



#### Dimensioned drawing

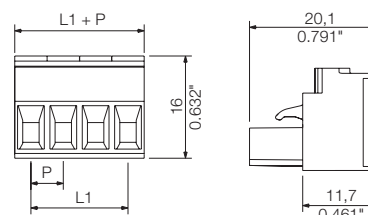

## G

### Technical data

#### In compliance with IEC 60664-1 / IEC 61984

Clamping range, max.	mm <sup>2</sup>	0.13...4
<b>Solid core H05(07) V-U</b>	<b>mm<sup>2</sup></b>	<b>0.2...4</b>
Stranded H07 V-R		
Flexible H05(07) V-K	mm <sup>2</sup>	0.2...4
Flexible with ferrule	mm <sup>2</sup>	0.2...4
Ferrule with plastic collar	mm <sup>2</sup>	0.2...2.5
Stripping length	mm	7
Screwdriver blade	mm	0.6 x 3.5, PH 1
According to norm		DIN 5264
Tightening torque range	Nm	0.4...0.5
<b>Rated current, max.</b>	<b>A</b>	<b>23 21</b>
At ambient temperature		20°C 40°C
For conductor cross-section	mm <sup>2</sup>	4
Overvoltage category		III III II
Pollution severity		3 2 2
<b>Rated voltage</b>	<b>V</b>	<b>250 320 400</b>
Rated impulse voltage	kV	4 4 4
<b>UL / CUL (Use Group)</b>	<b>B C D</b>	
<b>Rated voltage</b>	<b>V</b>	<b>300 300</b>
<b>Rated current</b>	<b>A</b>	<b>20 10</b>
<b>AWG conductor</b>	<b>AWG</b>	<b>26-12</b>
<b>CSA (Use Group)</b>	<b>B C D</b>	
Rated voltage	V	300 50 300
Rated current	A	20 20
AWG conductor	AWG	30-12

#### General data

Type of insulation material	PBT
UL 94 flammability rating	V-0
Contact base material	Copper alloy
Material of contact surface	tinned
Pin dimensions = d	mm
Solder eyelet Ø = D	mm
Solder eyelet Ø tolerance	mm

### Accessories

Note: Refer to the Accessories chapter for additional accessories.

Strain relief		Order No.
	BLZ 5.00 ZE04 OR BX	1652100000
	BLZ 5.00 ZE08 OR BX	1652040000
	BLZ 5.00 ZE08 BK BX	1652060000
Coding		
	BLZ/SL KO OR BX	1573010000
	BLZ/SL KO BK BX	1545710000
Screwdriver		
	SDS 0.6X3.5X100	9008330000
	SDIS 0.6X3.5X100	9008390000
	SDK PZ1	9008530000
Crosshead screwdriver		
	SDK PH1	9008480000

### Ordering data

Solder pin length				
Colour	Orange			
Pitch	5.00 mm			
Pol.	L1	(inch)	Qty.	Order No.
2	5.00	0.197	180	1954490000
3	10.00	0.394	120	1954480000
4	15.00	0.591	90	1954470000
5	20.00	0.788	72	1954460000
6	25.00	0.985	60	1954450000
7	30.00	1.182	48	1954440000
8	35.00	1.379	42	1954430000
9	40.00	1.576	36	1954420000
10	45.00	1.773	36	1954410000
11	50.00	1.970	30	1954400000
12	55.00	2.167	30	1954390000
13	60.00	2.364	24	1954380000
14	65.00	2.561	24	1954370000
15	70.00	2.758	24	1954360000
16	75.00	2.955	18	1954350000
17	80.00	3.152	18	1954330000
18	85.00	3.349	18	1954320000
19	90.00	3.546	18	1954310000
20	95.00	3.743	18	1954300000
21	100.00	3.940	12	1954290000
22	105.00	4.137	12	1954280000
23	110.00	4.334	12	1954270000
24	115.00	4.531	12	1954260000

### Representative deratings curve

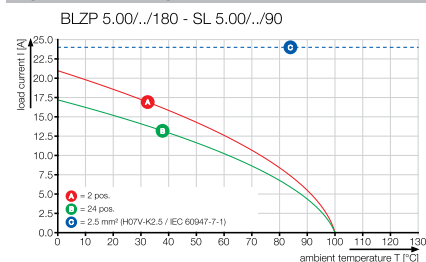

**BLZP 5.00HC/././180F**



Dimensioned drawing

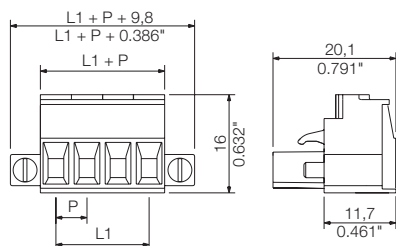

**Ordering data**

Solder pin length					
Colour		Orange			
Pitch	5.00 mm				
Pol.	L1	(inch)	Qty.	Order No.	
2	5.00	0.197	90	1955800000	
3	10.00	0.394	72	1955790000	
4	15.00	0.591	60	1955780000	
5	20.00	0.788	48	1955770000	
6	25.00	0.985	42	1955760000	
7	30.00	1.182	36	1955750000	
8	35.00	1.379	36	1955740000	
9	40.00	1.576	30	1955730000	
10	45.00	1.773	30	1955720000	
11	50.00	1.970	24	1955710000	
12	55.00	2.167	24	1955700000	
13	60.00	2.364	24	1955690000	
14	65.00	2.561	18	1955680000	
15	70.00	2.758	18	1955670000	
16	75.00	2.955	18	1955660000	
17	80.00	3.152	18	1955650000	
18	85.00	3.349	18	1955640000	
19	90.00	3.546	12	1955630000	
20	95.00	3.743	12	1955620000	
21	100.00	3.940	12	1955610000	
22	105.00	4.137	12	1955600000	
23	110.00	4.334	12	1955590000	
24	115.00	4.531	12	1955580000	

**BLZP 5.00HC/././180LR**

with lock and release lever



Dimensioned drawing

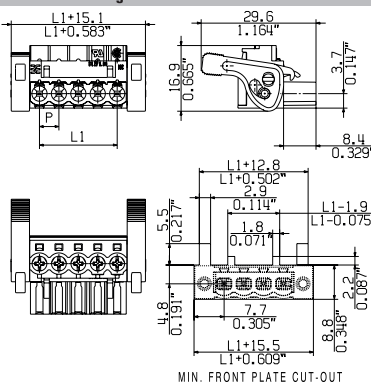

**Ordering data**

Solder pin length					
Colour		Orange			
Pitch	5.00 mm				
Pol.	L1	(inch)	Qty.	Order No.	
2	5.00	0.197	90	1956370000	
3	10.00	0.394	72	1956360000	
4	15.00	0.591	60	1956350000	
5	20.00	0.788	48	1956340000	
6	25.00	0.985	42	1956330000	
7	30.00	1.182	36	1956320000	
8	35.00	1.379	36	1956310000	
9	40.00	1.576	30	1956300000	
10	45.00	1.773	30	1956290000	
11	50.00	1.970	24	1956280000	
12	55.00	2.167	24	1956270000	
13	60.00	2.364	24	1956260000	
14	65.00	2.561	18	1956250000	
15	70.00	2.758	18	1956240000	
16	75.00	2.955	18	1956230000	
17	80.00	3.152	18	1956220000	
18	85.00	3.349	18	1956210000	
19	90.00	3.546	12	1956200000	
20	95.00	3.743	12	1956190000	
21	100.00	3.940	12	1956180000	
22	105.00	4.137	12	1956170000	
23	110.00	4.334	12	1956160000	
24	115.00	4.531	12	1956150000	

**The 2-in-1 contact**

Every pluggable connector covers two contact points and thus must meet two different requirements: First, the wire termination and second, the connection between plug and pin header. Referring to the 5.0x pitch series, Weidmüller offers different wire connection technologies, but one platform contact for the male / female connection since years. This well-designed hybride platform contact ensures a constant quality on a very high level. Hybride means, that we combine metal material featuring different characteristics by welding, in order to devide the contact system into different function zones: Further to the high electric conductance, the current bar is characterized by its hardness, and the tulip contact by its excellent tension properties. The advantage: each function is supported by the most suitable material to reliably and constantly meet the different electrical and mechanical requirements. To put it in a nutshell: Instead of either ... or, it's even both - perfect for the current, and perfect for the force.



**Additional deratings curves**

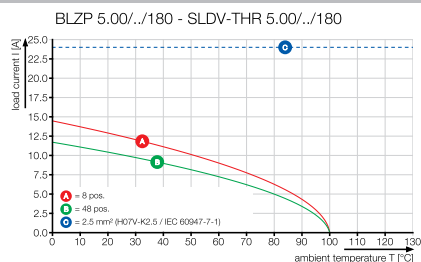
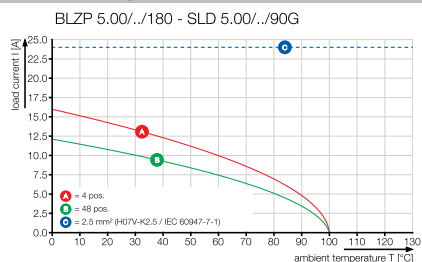

## Connectors in 5.00 mm pitch Series BL/SL 5.00

### BLZP 5.00HC../90

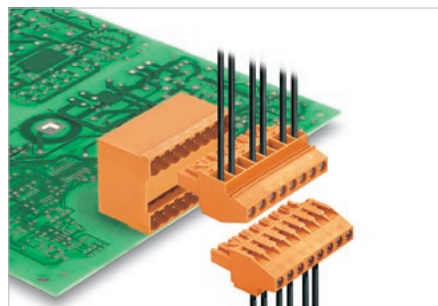

The BLZP is the functional extension of the BLZ series. The "P" in the part name stands for a plus in security and performance in processing and use.

- WIRE READY - delivered with terminal points already opened
- Power tools can be used with the globally compatible plus/minus screw head
- Folded steel clamping yoke accommodates the connected wire and compensates for temperature fluctuations
- The integrated wire guard prevents dangerous under-insertion of the wire from occurring.
- Lock and release-lever: tool-less locking and gentle releasing of the connector reduces the mechanical stress on the solder joints.

### Product data

IEC: 400 V / 23 A / 0.2 - 4 mm<sup>2</sup>  
UL: 300 V / 20 A / AWG 26 - 12



For additional articles and information, refer to [catalog.weidmueller.com](http://catalog.weidmueller.com)

#### Note:

- Additional colours on request
- Gold-plated contact surfaces on request
- Rated current related to rated cross-section & min. No. of poles.
- Wire end ferrule without plastic collar to DIN 46228/1
- Wire end ferrule with plastic collar to DIN 46228/4
- P on drawing = pitch
- Rated data refer only to the component itself. Clearance and creepage distances to other components are to be designed in accordance with the relevant application standards.

### BLZP 5.00HC../90



#### Dimensioned drawing

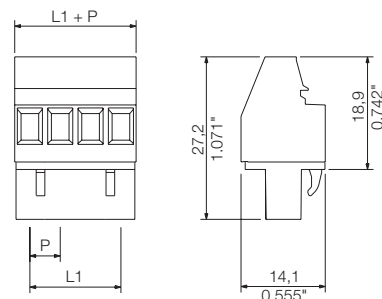

### Technical data

#### In compliance with IEC 60664-1 / IEC 61984

Clamping range, max.	mm <sup>2</sup>	0.13...4
<b>Solid core H05(07) V-U</b>	<b>mm<sup>2</sup></b>	<b>0.2...4</b>
Stranded H07 V-R		
Flexible H05(07) V-K	mm <sup>2</sup>	0.2...4
Flexible with ferrule	mm <sup>2</sup>	0.2...4
Ferrule with plastic collar	mm <sup>2</sup>	0.2...2.5
Stripping length	mm	7
Screwdriver blade	mm	0.6 x 3.5, PH 1

According to norm

Tightening torque range	Nm	0.4...0.5
<b>Rated current, max.</b>	<b>A</b>	<b>23 21</b>
At ambient temperature	20°C	40°C
For conductor cross-section	mm <sup>2</sup>	4
Overvoltage category		III III II
Pollution severity		3 2 2
<b>Rated voltage</b>	<b>V</b>	<b>250 320 400</b>
Rated impulse voltage	kV	4 4 4

#### UL / CUL (Use Group)

<b>Rated voltage</b>	<b>V</b>	<b>300 300</b>
<b>Rated current</b>	<b>A</b>	<b>20 10</b>
<b>AWG conductor</b>	<b>AWG</b>	<b>26-12</b>
<b>CSA (Use Group)</b>	<b>B C D</b>	
Rated voltage	V	300 50 300
Rated current	A	20 20 20
AWG conductor	AWG	30-12

#### General data

Type of insulation material	PBT
UL 94 flammability rating	V-0
Contact base material	Copper alloy
Material of contact surface	tinned
Pin dimensions = d	mm
Solder eyelet Ø = D	mm
Solder eyelet Ø tolerance	mm

### Accessories

Note: Refer to the Accessories chapter for additional accessories.

Coding	Order No.
BLZ/SL KO OR BX	<b>1573010000</b>
BLZ/SL KO BK BX	<b>1545710000</b>
Screwdriver	
SDS 0.6X3.5X100	<b>9008330000</b>
SDIS 0.6X3.5X100	<b>9008390000</b>
SDK PZ1	<b>9008530000</b>
Crosshead screwdriver	
SDK PH1	<b>9008480000</b>

### Ordering data

Solder pin length				
Colour	Orange			
Pitch	5.00 mm			
Pol.	L1	(inch)	Qty.	Order No.
2	5.00	0.197	180	<b>1958300000</b>
3	10.00	0.394	120	<b>1958290000</b>
4	15.00	0.591	90	<b>1958280000</b>
5	20.00	0.788	72	<b>1958270000</b>
6	25.00	0.985	60	<b>1958260000</b>
7	30.00	1.182	48	<b>1958250000</b>
8	35.00	1.379	42	<b>1958230000</b>
9	40.00	1.576	36	<b>1958190000</b>
10	45.00	1.773	36	<b>1958160000</b>
11	50.00	1.970	30	<b>1958130000</b>
12	55.00	2.167	30	<b>1958120000</b>
13	60.00	2.364	24	<b>1958090000</b>
14	65.00	2.561	24	<b>1958060000</b>
15	70.00	2.758	24	<b>1958040000</b>
16	75.00	2.955	18	<b>1957960000</b>
17	80.00	3.152	18	<b>1957910000</b>
18	85.00	3.349	18	<b>1957900000</b>
19	90.00	3.546	18	<b>1957880000</b>
20	95.00	3.743	18	<b>1957850000</b>
21	100.00	3.940	12	<b>1957830000</b>
22	105.00	4.137	12	<b>1957820000</b>
23	110.00	4.334	12	<b>1957800000</b>
24	115.00	4.531	12	<b>1957780000</b>

### Representative deratings curve

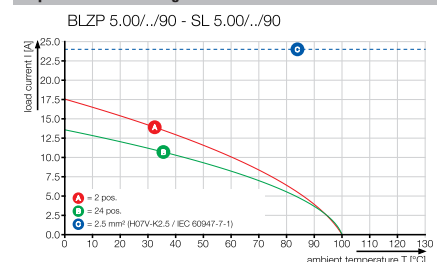



## BLZP 5.00HC/./90F



Dimensioned drawing

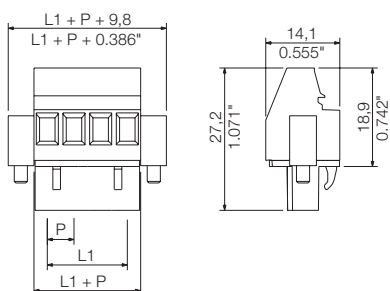

## Ordering data

Solder pin length				
Colour	Orange			
Pitch	5.00 mm <th colspan="2"></th>			
Pol.	L1	(inch)	Qty.	Order No.
2	5.00	0.197	90	1959520000
3	10.00	0.394	72	1959510000
4	15.00	0.591	60	1959500000
5	20.00	0.788	48	1959490000
6	25.00	0.985	42	1959480000
7	30.00	1.182	36	1959470000
8	35.00	1.379	36	1959460000
9	40.00	1.576	30	1959440000
10	45.00	1.773	30	1959430000
11	50.00	1.970	24	1959390000
12	55.00	2.167	24	1959370000
13	60.00	2.364	24	1959360000
14	65.00	2.561	18	1959350000
15	70.00	2.758	18	1959340000
16	75.00	2.955	18	1959330000
17	80.00	3.152	18	1959320000
18	85.00	3.349	18	1959300000
19	90.00	3.546	12	1959290000
20	95.00	3.743	12	1959270000
21	100.00	3.940	12	1959250000
22	105.00	4.137	12	1959240000
23	110.00	4.334	12	1959220000
24	115.00	4.531	12	1959200000

## Additional deratings curves

BLZP 5.00/./90 - SL-SMT 5.00/./90

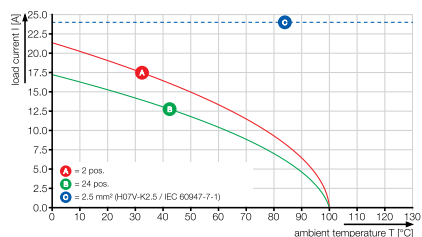

## The 2-in-1 contact

Every pluggable connector covers two contact points and thus must meet two different requirements: First, the wire termination and second, the connection between plug and pin header. Referring to the 5.0x pitch series, Weidmüller offers different wire connection technologies, but one platform contact for the male / female connection since years. This well-designed hybrid platform contact ensures a constant quality on a very high level.

Hybrid means, that we combine metal material featuring different characteristics by welding, in order to divide the contact system into different function zones: Further to the high electric conductance, the current bar is characterized by its hardness, and the tulip contact by its excellent tension properties. The advantage: each function is supported by the most suitable material to reliably and constantly meet the different electrical and mechanical requirements. To put it in a nutshell: Instead of either ... or, it's even both - perfect for the current, and perfect for the force.



## Connectors in 5.00 mm pitch Series BL/SL 5.00

### BLZP 5.00HC../270

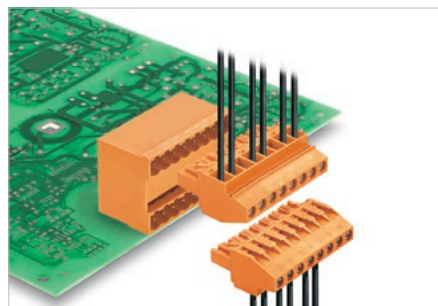

The BLZP is the functional extension of the BLZ series. The "P" in the part name stands for a plus in security and performance in processing and use.

- WIRE READY - delivered with terminal points already opened
- Power tools can be used with the globally compatible plus/minus screw head
- Folded steel clamping yoke accommodates the connected wire and compensates for temperature fluctuations
- The integrated wire guard prevents dangerous under-insertion of the wire from occurring.
- Lock and release-lever: tool-less locking and gentle releasing of the connector reduces the mechanical stress on the solder joints.

### Product data

IEC: 400 V / 23 A / 0.2 - 4 mm<sup>2</sup>  
UL: 300 V / 20 A / AWG 26 - 12



For additional articles and information, refer to [catalog.weidmueller.com](http://catalog.weidmueller.com)

#### Note:

- Additional colours on request
- Gold-plated contact surfaces on request
- Rated current related to rated cross-section & min. No. of poles.
- Wire end ferrule without plastic collar to DIN 46228/1
- Wire end ferrule with plastic collar to DIN 46228/4
- P on drawing = pitch
- Rated data refer only to the component itself. Clearance and creepage distances to other components are to be designed in accordance with the relevant application standards.

### BLZP 5.00HC../270



#### Dimensioned drawing

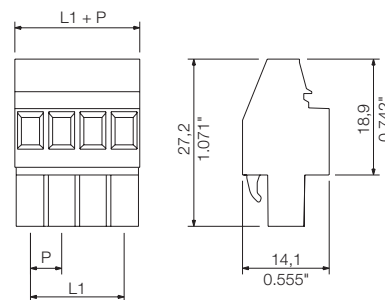

### Technical data

In compliance with IEC 60664-1 / IEC 61984			
Clamping range, max.	mm <sup>2</sup>	0.13...4	
<b>Solid core H05(07) V-U</b>	<b>mm<sup>2</sup></b>	<b>0.2...4</b>	
Stranded H07 V-R			
Flexible H05(07) V-K	mm <sup>2</sup>	0.2...4	
Flexible with ferrule	mm <sup>2</sup>	0.2...4	
Ferrule with plastic collar	mm <sup>2</sup>	0.2...2.5	
Stripping length	mm	7	
Screwdriver blade	mm	0.6 x 3.5, PH 1	
According to norm			
Tightening torque range	Nm	0.4...0.5	
<b>Rated current, max.</b>	<b>A</b>	<b>23</b>	<b>21</b>
At ambient temperature		20°C	40°C
For conductor cross-section	mm <sup>2</sup>	4	
Overvoltage category		III	III II
Pollution severity		3	2 2
<b>Rated voltage</b>	<b>V</b>	<b>250</b>	<b>320 400</b>
Rated impulse voltage	kV	4	4 4
<b>UL / CUL (Use Group)</b>		<b>B</b>	<b>C D</b>
<b>Rated voltage</b>	<b>V</b>	<b>300</b>	<b>300</b>
<b>Rated current</b>	<b>A</b>	<b>20</b>	<b>10</b>
<b>AWG conductor</b>	<b>AWG</b>	<b>26-12</b>	
<b>CSA (Use Group)</b>		<b>B</b>	<b>C D</b>
Rated voltage	V	300	50 300
Rated current	A	20	20
AWG conductor	AWG	30-12	
<b>General data</b>			
Type of insulation material		PBT	
UL 94 flammability rating		V-0	
Contact base material		Copper alloy	
Material of contact surface		tinned	
Pin dimensions = d	mm		
Solder eyelet Ø = D			
Solder eyelet Ø tolerance	mm		

### Accessories

Note: Refer to the Accessories chapter for additional accessories.

Coding	Order No.
BLZ/SL KO OR BX	<b>1573010000</b>
BLZ/SL KO BK BX	<b>1545710000</b>
<b>Screwdriver</b>	
SDS 0.6X3.5X100	<b>9008330000</b>
SDIS 0.6X3.5X100	<b>9008390000</b>
SDK PZ1	<b>9008530000</b>
<b>Crosshead screwdriver</b>	
SDK PH1	<b>9008480000</b>

### Ordering data

Solder pin length				
Colour	Orange			
Pitch	5.00 mm			
Pol.	L1	(inch)	Qty.	Order No.
2	5.00	0.197	180	<b>1958870000</b>
3	10.00	0.394	120	<b>1958860000</b>
4	15.00	0.591	90	<b>1958850000</b>
5	20.00	0.788	72	<b>1958840000</b>
6	25.00	0.985	60	<b>1958830000</b>
7	30.00	1.182	48	<b>1958820000</b>
8	35.00	1.379	42	<b>1958810000</b>
9	40.00	1.576	36	<b>1958800000</b>
10	45.00	1.773	36	<b>1958790000</b>
11	50.00	1.970	30	<b>1958780000</b>
12	55.00	2.167	30	<b>1959150000</b>
13	60.00	2.364	24	<b>1958770000</b>
14	65.00	2.561	24	<b>1958760000</b>
15	70.00	2.758	24	<b>1958750000</b>
16	75.00	2.955	18	<b>1958740000</b>
17	80.00	3.152	18	<b>1958730000</b>
18	85.00	3.349	18	<b>1958720000</b>
19	90.00	3.546	18	<b>1958710000</b>
20	95.00	3.743	18	<b>1958700000</b>
21	100.00	3.940	12	<b>1958690000</b>
22	105.00	4.137	12	<b>1958680000</b>
23	110.00	4.334	12	<b>1958670000</b>
24	115.00	4.531	12	<b>1958660000</b>

### Representative deratings curve

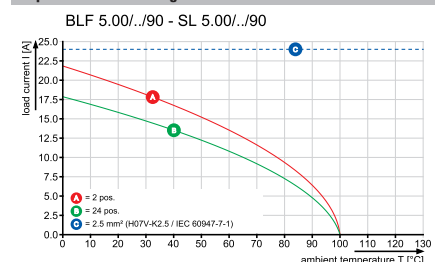

**BLZP 5.00HC../270F**



Dimensioned drawing

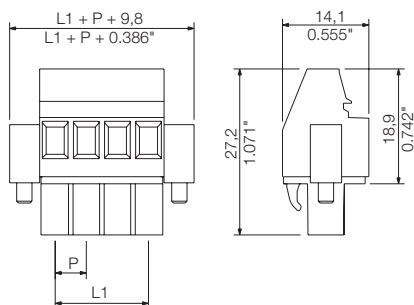

**Ordering data**

Solder pin length					
Colour		Orange			
Pitch	5.00 mm				
Pol.	L1	(inch)	Qty.	Order No.	
2	5.00	0.197	90	1960460000	
3	10.00	0.394	72	1960450000	
4	15.00	0.591	60	1960440000	
5	20.00	0.788	48	1960430000	
6	25.00	0.985	42	1960420000	
7	30.00	1.182	36	1960410000	
8	35.00	1.379	36	1960400000	
9	40.00	1.576	30	1960390000	
10	45.00	1.773	30	1960380000	
11	50.00	1.970	24	1960370000	
12	55.00	2.167	24	1959450000	
13	60.00	2.364	24	1959420000	
14	65.00	2.561	18	1959410000	
15	70.00	2.758	18	1959400000	
16	75.00	2.955	18	1959380000	
17	80.00	3.152	18	1959310000	
18	85.00	3.349	18	1959280000	
19	90.00	3.546	12	1959260000	
20	95.00	3.743	12	1959230000	
21	100.00	3.940	12	1959210000	
22	105.00	4.137	12	1959190000	
23	110.00	4.334	12	1959180000	
24	115.00	4.531	12	1959170000	

**BLZP 5.00HC../270LR**

with lock and release lever



Dimensioned drawing

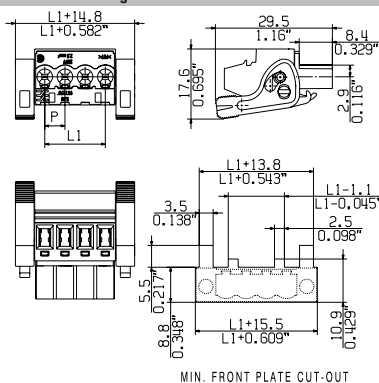

**Ordering data**

Solder pin length					
Colour		Orange			
Pitch	5.00 mm				
Pol.	L1	(inch)	Qty.	Order No.	
2	5.00	0.197	90	1960960000	
3	10.00	0.394	72	1960950000	
4	15.00	0.591	60	1960940000	
5	20.00	0.788	48	1960930000	
6	25.00	0.985	42	1960920000	
7	30.00	1.182	36	1960910000	
8	35.00	1.379	36	1960900000	
9	40.00	1.576	30	1960890000	
10	45.00	1.773	30	1960880000	
11	50.00	1.970	24	1960870000	
12	55.00	2.167	24	1960860000	
13	60.00	2.364	24	1960850000	
14	65.00	2.561	18	1960840000	
15	70.00	2.758	18	1960830000	
16	75.00	2.955	18	1960820000	
17	80.00	3.152	18	1960810000	
18	85.00	3.349	18	1960800000	
19	90.00	3.546	12	1960790000	
20	95.00	3.743	12	1960780000	
21	100.00	3.940	12	1960770000	
22	105.00	4.137	12	1960760000	
23	110.00	4.334	12	1960750000	
24	115.00	4.531	12	1960740000	

**The 2-in-1 contact**

Every pluggable connector covers two contact points and thus must meet two different requirements: First, the wire termination and second, the connection between plug and pin header. Referring to the 5.0x pitch series, Weidmüller offers different wire connection technologies, but one platform contact for the male / female connection since years. This well-designed hybride platform contact ensures a constant quality on a very high level. Hybride means, that we combine metal material featuring different characteristics by welding, in order to devide the contact system into different function zones: Further to the high electric conductance, the current bar is characterized by its hardness, and the tulip contact by its excellent tension properties. The advantage: each function is supported by the most suitable material to reliably and constantly meet the different electrical and mechanical requirements. To put it in a nutshell: Instead of either ... or, it's even both - perfect for the current, and perfect for the force.



## Connectors in 5.00 mm pitch Series BL/SL 5.00

### BLF 5.00HC../180

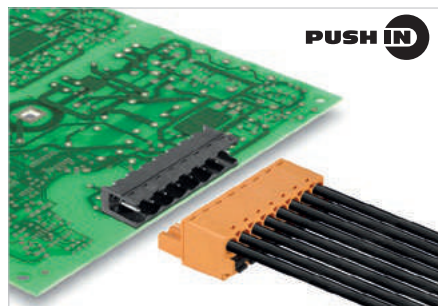

"PUSH IN" - Weidmüller's innovative connection system simplifies and accelerates the wire connection process.

- Solid wires and stranded wires with ferrules need only to be inserted and they are ready.
- The actuator must be used when connecting stranded wires without ferrules.
- Intuitive handling - since the wire-entry area and handling area are clearly separated.
- User-friendly handling with rounded outer edges and large, no-slip push buttons.
- Lock and release lever: tool-less locking and a gentle releasing of the connector reduces the mechanical stress to the solder joints.

### Product data

IEC: 400 V / 23 A / 0.2 - 2.5 mm<sup>2</sup>  
UL: 300 V / 18.5 A / AWG 26 - 12



For additional articles and information, refer to [catalog.weidmueller.com](http://catalog.weidmueller.com)

#### Note:

- Additional colours on request
- Gold-plated contact surfaces on request
- Rated current related to rated cross-section & min. No. of poles.
- Wire end ferrule without plastic collar to DIN 46228/1
- Wire end ferrule with plastic collar to DIN 46228/4
- P on drawing = pitch

### BLF 5.00HC../180



#### Dimensioned drawing

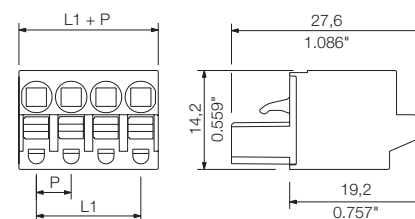

### Technical data

In compliance with IEC 60664-1 / IEC 61984			
Clamping range, max.	mm <sup>2</sup>	0.13...3.31	
<b>Solid core H05(07) V-U</b>	mm <sup>2</sup>	<b>0.2...2.5</b>	
Stranded H07 V-R			
Flexible H05(07) V-K	mm <sup>2</sup>	0.2...2.5	
Flexible with ferrule	mm <sup>2</sup>	0.25...2.5	
Ferrule with plastic collar	mm <sup>2</sup>	0.25...2.5	
Stripping length	mm	10	
Screwdriver blade	mm	0.6 x 3.5	
		According to norm DIN 5264	
Tightening torque range			
<b>Rated current, max.</b>	<b>A</b>	<b>23</b>	<b>21</b>
At ambient temperature		20°C	40°C
For conductor cross-section	mm <sup>2</sup>	2.5	
Overvoltage category		III	III II
Pollution severity		3	2 2
<b>Rated voltage</b>	<b>V</b>	<b>250</b>	<b>320 400</b>
Rated impulse voltage	kV	4	4 4
<b>UL / CUL (Use Group)</b>		<b>B</b>	<b>C D</b>
<b>Rated voltage</b>	<b>V</b>	<b>300</b>	<b>300</b>
<b>Rated current</b>	<b>A</b>	<b>18.5</b>	<b>10</b>
<b>AWG conductor</b>	<b>AWG</b>	<b>26-12</b>	
<b>CSA (Use Group)</b>		<b>B</b>	<b>C D</b>
Rated voltage	V	300	300
Rated current	A	10	10
AWG conductor	AWG	12-26	
General data			
Type of insulation material		PBT	
UL 94 flammability rating		V-0	
Contact base material		CuSn	
Material of contact surface		tinned	
Pin dimensions = d	mm		
Solder eyelet Ø = D	mm		
Solder eyelet Ø tolerance	mm		

### Accessories

Note: Refer to the Accessories chapter for additional accessories.

Coding	Order No.
BLZ/SL KO OR BX	<b>1573010000</b>
BLZ/SL KO BK BX	<b>1545710000</b>
Screwdriver	
SDS 0.6X3.5X100	<b>9008330000</b>
SDIS 0.6X3.5X100	<b>9008390000</b>
Wire-end ferrule	
H0,5/14S W	<b>9004590000</b>
H1,0/14S R	<b>9018560000</b>
H1,5/14S SW	<b>9025240000</b>
H2,5/14S BL	<b>1333100000</b>

### Ordering data

Solder pin length				
Colour	Orange			
Pitch	5.00 mm			
Pol.	L1	(inch)	Qty.	Order No.
2	5.00	0.197	180	<b>1017860000</b>
3	10.00	0.394	120	<b>1017870000</b>
4	15.00	0.591	90	<b>1017880000</b>
5	20.00	0.788	72	<b>1017890000</b>
6	25.00	0.985	60	<b>1017910000</b>
7	30.00	1.182	48	<b>1017920000</b>
8	35.00	1.379	42	<b>1017930000</b>
9	40.00	1.576	36	<b>1017950000</b>
10	45.00	1.773	36	<b>1017960000</b>
11	50.00	1.970	30	<b>1017970000</b>
12	55.00	2.167	30	<b>1017980000</b>
13	60.00	2.364	24	<b>1017990000</b>
14	65.00	2.561	24	<b>1018010000</b>
15	70.00	2.758	24	<b>1018020000</b>
16	75.00	2.955	18	<b>1018030000</b>
17	80.00	3.152	18	<b>1018040000</b>
18	85.00	3.349	18	<b>1018050000</b>

### Representative deratings curve

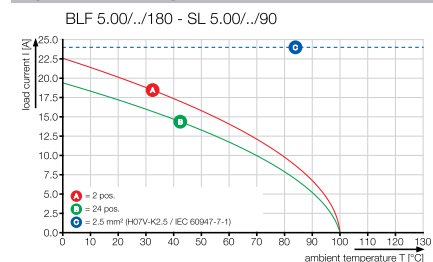

BLF 5.00HC../180F



Dimensioned drawing

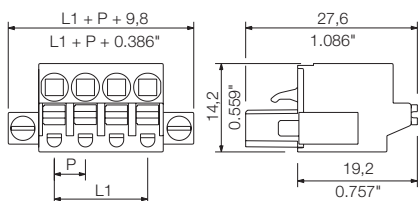

Ordering data

Solder pin length					
Colour					Orange
Pitch	5.00 mm				
Pol.	L1	(inch)	Qty.	Order No.	
2	5.00	0.197	90	1017420000	
3	10.00	0.394	72	1017430000	
4	15.00	0.591	60	1017440000	
5	20.00	0.788	48	1017450000	
6	25.00	0.985	42	1017470000	
7	30.00	1.182	36	1017480000	
8	35.00	1.379	36	1017490000	
9	40.00	1.576	30	1017510000	
10	45.00	1.773	30	1017520000	
11	50.00	1.970	24	1017530000	
12	55.00	2.167	24	1017540000	
13	60.00	2.364	24	1017550000	
14	65.00	2.561	18	1017570000	
15	70.00	2.758	18	1017590000	
16	75.00	2.955	18	1017600000	
17	80.00	3.152	18	1017610000	
18	85.00	3.349	18	1017620000	

BLF 5.00HC../180LR



Dimensioned drawing

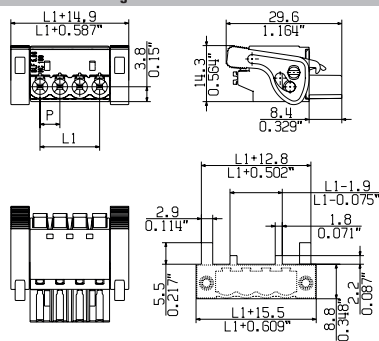

MIN. FRONT PLATE CUT-OUT

Ordering data

Solder pin length					
Colour					Orange
Pitch	5.00 mm				
Pol.	L1	(inch)	Qty.	Order No.	
2	5.00	0.197	90	1016340000	
3	10.00	0.394	72	1016350000	
4	15.00	0.591	60	1016360000	
5	20.00	0.788	48	1016370000	
6	25.00	0.985	42	1016380000	
7	30.00	1.182	36	1016390000	
8	35.00	1.379	36	1016410000	
9	40.00	1.576	30	1016420000	
10	45.00	1.773	30	1016430000	
11	50.00	1.970	24	1016440000	
12	55.00	2.167	24	1016450000	
13	60.00	2.364	24	1016460000	
14	65.00	2.561	18	1016470000	
15	70.00	2.758	18	1016480000	
16	75.00	2.955	18	1016490000	
17	80.00	3.152	18	1016510000	
18	85.00	3.349	18	1016520000	

PUSH IN connection technology

"PUSH IN" connection technology reduces the wiring efforts especially for solid wires and wires with ferrule to a minimum. These connectors are self-explanatory and enable tool-less handling. The contact element made of stainless steel ensures a vibration proof, maintenance free wire termination. The established principle "STEEL FOR THE FORCE, COPPER FOR THE CURRENT" by Weidmüller offers both, maximum conductor clamping forces, as well as minimum power loss at the same time.



The 2-in-1 contact

Every pluggable connector covers two different requirements: First, the wire termination and second, the connection between plug and pin header. Referring to the 5.0x pitch series, Weidmüller offers different wire connection technologies, but one platform contact for the male / female connection since years. This well-designed hybride platform contact ensures a constant quality on a very high level. Hybride means, that we combine metal material featuring different characteristics by welding, in order to divide the contact system into different function zones: Further to the high electric conductance, the current bar is characterized by its hardness, and the tulip contact by its excellent tension properties. The advantage: each function is supported by the most suitable material to reliably and constantly meet the different electrical and mechanical requirements. To put it in a nutshell: Instead of either ... or, it's even both - perfect for the current, and perfect for the force.



## Connectors in 5.00 mm pitch Series BL/SL 5.00

### BLF 5.00HC/./90

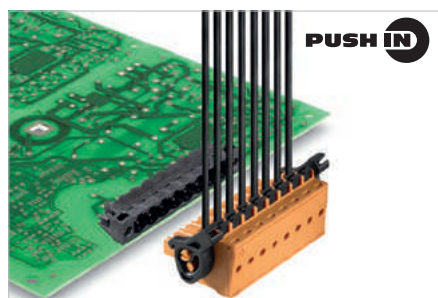

"PUSH IN" - Weidmüller's innovative connection system simplifies and accelerates the wire connection process.

- Solid wires and stranded wires with ferrules need only to be inserted and they are ready.
- The actuator must be used when connecting stranded wires without ferrules.
- Intuitive handling - since the wire-entry area and handling area are clearly separated.
- User-friendly handling with rounded outer edges and large, no-slip push buttons.
- Lock and release lever: tool-less locking and a gentle releasing of the connector reduces the mechanical stress to the solder joints.

### Product data

IEC: 400 V / 24 A / 0.2 - 2.5 mm<sup>2</sup>  
UL: 300 V / 18.5 A / AWG 26 - 12



For additional articles and information, refer to [catalog.weidmueller.com](http://catalog.weidmueller.com)

#### Note:

- Additional colours on request
- Gold-plated contact surfaces on request
- Rated current related to rated cross-section & min. No. of poles.
- Wire end ferrule without plastic collar to DIN 46228/1
- Wire end ferrule with plastic collar to DIN 46228/4
- P on drawing = pitch

### BLF 5.00HC/./90



#### Dimensioned drawing

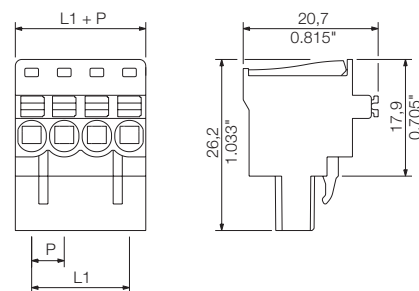

### Technical data

In compliance with IEC 60664-1 / IEC 61984			
Clamping range, max.	mm <sup>2</sup>	0.13...3.31	
<b>Solid core H05(07) V-U</b>	mm <sup>2</sup>	<b>0.2...2.5</b>	
Stranded H07 V-R			
Flexible H05(07) V-K	mm <sup>2</sup>	0.2...2.5	
Flexible with ferrule	mm <sup>2</sup>	0.25...2.5	
Ferrule with plastic collar	mm <sup>2</sup>	0.25...2.5	
Stripping length	mm	10	
Screwdriver blade	mm	0.6 x 3.5	
According to norm DIN 5264			
Tightening torque range			
<b>Rated current, max.</b>	<b>A</b>	<b>24</b>	<b>21</b>
At ambient temperature 20°C 40°C			
For conductor cross-section	mm <sup>2</sup>	2.5	
Overvoltage category		III	III II
Pollution severity		3	2 2
<b>Rated voltage</b>	<b>V</b>	<b>250</b>	<b>320 400</b>
Rated impulse voltage	kV	4	4 4
<b>UL / CUL (Use Group)</b>		<b>B</b>	<b>C D</b>
<b>Rated voltage</b>	<b>V</b>	<b>300</b>	<b>300</b>
<b>Rated current</b>	<b>A</b>	<b>18.5</b>	<b>10</b>
<b>AWG conductor</b>	<b>AWG</b>	<b>26-12</b>	
<b>CSA (Use Group)</b>		<b>B</b>	<b>C D</b>
Rated voltage	V	300	300
Rated current	A	10	10
AWG conductor	AWG	12-26	
General data			
Type of insulation material		PBT	
UL 94 flammability rating		V-0	
Contact base material		CuSn	
Material of contact surface		tinned	
Pin dimensions = d	mm		
Solder eyelet Ø = D	mm		
Solder eyelet Ø tolerance	mm		

### Accessories

Note: Refer to the Accessories chapter for additional accessories.

Coding	Order No.
BLZ/SL KO OR BX	<b>1573010000</b>
BLZ/SL KO BK BX	<b>1545710000</b>
Screwdriver	
SDS 0.6X3.5X100	<b>9008330000</b>
SDIS 0.6X3.5X100	<b>9008390000</b>
Wire-end ferrule	
H0,5/14S W	<b>9004590000</b>
H1,0/14S R	<b>9018560000</b>
H1,5/14S SW	<b>9025240000</b>
H2,5/14S BL	<b>1333100000</b>

### Ordering data

Solder pin length				
Colour	Orange			
Pitch	5.00 mm			
Pol.	L1	(inch)	Qty.	Order No.
2	5.00	0.197	180	<b>1980170000</b>
3	10.00	0.394	120	<b>1980180000</b>
4	15.00	0.591	90	<b>1980190000</b>
5	20.00	0.788	72	<b>1980200000</b>
6	25.00	0.985	60	<b>1980210000</b>
7	30.00	1.182	48	<b>1980220000</b>
8	35.00	1.379	42	<b>1980230000</b>
9	40.00	1.576	36	<b>1980240000</b>
10	45.00	1.773	36	<b>1980250000</b>
11	50.00	1.970	30	<b>1980260000</b>
12	55.00	2.167	30	<b>1980270000</b>
13	60.00	2.364	24	<b>1980280000</b>
14	65.00	2.561	24	<b>1980290000</b>
15	70.00	2.758	24	<b>1980300000</b>
16	75.00	2.955	18	<b>1980310000</b>
17	80.00	3.152	18	<b>1980320000</b>
18	85.00	3.349	18	<b>1980330000</b>
19	90.00	3.546	18	<b>1980340000</b>
20	95.00	3.743	18	<b>1980360000</b>

### Representative deratings curve

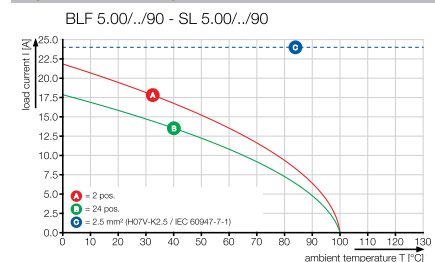

**BLF 5.00HC../90F**



Dimensioned drawing

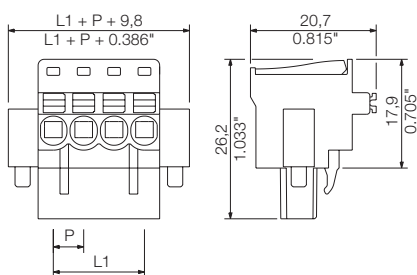

**Ordering data**

Solder pin length					
Colour					Orange
Pitch	5.00 mm				
Pol.	L1	(inch)	Qty.	Order No.	
2	5.00	0.197	90	1980640000	
3	10.00	0.394	72	1980650000	
4	15.00	0.591	60	1980660000	
5	20.00	0.788	48	1980670000	
6	25.00	0.985	42	1980680000	
7	30.00	1.182	36	1980690000	
8	35.00	1.379	36	1980700000	
9	40.00	1.576	30	1980710000	
10	45.00	1.773	30	1980720000	
11	50.00	1.970	24	1980730000	
12	55.00	2.167	24	1980740000	
13	60.00	2.364	24	1980750000	
14	65.00	2.561	18	1980760000	
15	70.00	2.758	18	1980780000	
16	75.00	2.955	18	1980790000	
17	80.00	3.152	18	1980800000	
18	85.00	3.349	18	1980810000	
19	90.00	3.546	12	1980820000	
20	95.00	3.743	12	1980840000	

**BLF 5.00HC../90LR**

with lock and release lever



Dimensioned drawing

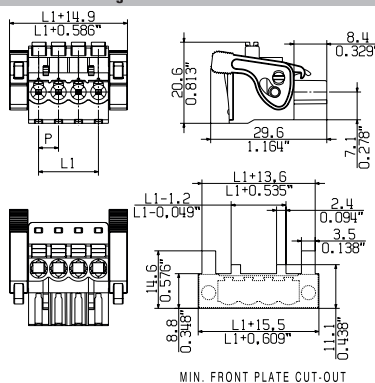

**Ordering data**

Solder pin length					
Colour					Orange
Pitch	5.00 mm				
Pol.	L1	(inch)	Qty.	Order No.	
2	5.00	0.197	90	1980870000	
3	10.00	0.394	72	1980880000	
4	15.00	0.591	60	1980890000	
5	20.00	0.788	48	1980900000	
6	25.00	0.985	42	1980910000	
7	30.00	1.182	36	1980920000	
8	35.00	1.379	36	1980930000	
9	40.00	1.576	30	1980940000	
10	45.00	1.773	30	1980950000	
11	50.00	1.970	24	1980960000	
12	55.00	2.167	24	1980970000	
13	60.00	2.364	24	1980980000	
14	65.00	2.561	18	1980990000	
15	70.00	2.758	18	1981000000	
16	75.00	2.955	18	1981010000	
17	80.00	3.152	18	1981020000	
18	85.00	3.349	18	1981030000	
19	90.00	3.546	12	1981040000	
20	95.00	3.743	12	1981050000	

**PUSH IN connection technology**

"PUSH IN" connection technology reduces the wiring affords especially for solid wires and wires with ferrule to a minimum. These connectors are self-explanatory and enable tool-less handling. The contact element made of stainless steel ensures a vibration proof, maintenance free wire termination. The established principle "STEEL FOR THE FORCE, COPPER FOR THE CURRENT" by Weidmüller offers both, maximum conductor clamping forces, as well as minimum power loss at the same time.



**The 2-in-1 contact**

Every pluggable connector covers two different requirements: First, the wire termination and second, the connection between plug and pin header. Referring to the 5.0x pitch series, Weidmüller offers different wire connection technologies, but one platform contact for the male / female connection since years. This well-designed hybride platform contact ensures a constant quality on a very high level. Hybride means, that we combine metal material featuring different characteristics by welding, in order to divide the contact system into different function zones: Further to the high electric conductance, the current bar is characterized by its hardness, and the tulip contact by its excellent tension properties. The advantage: each function is supported by the most suitable material to reliably and constantly meet the different electrical and mechanical requirements. To put it in a nutshell: Instead of either ... or, it's even both - perfect for the current, and perfect for the force.



## Connectors in 5.08 mm pitch Series BL/SL 5.08

### SL-SMT 5.08HC/./90

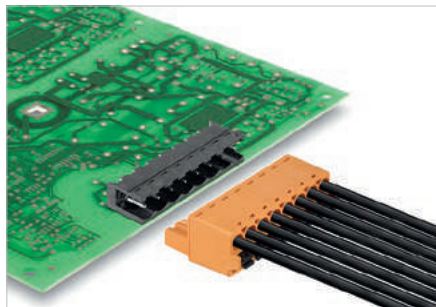

High-temperature-resistant, 90°-angled male header, optimised for SMT processing. The male headers can be manually coded or ordered as pre-coded headers.

- Available in open, closed (G), with screw flange (F) or with solder flange (LF).
- The solder flange substitutes a screw fastening to the PCB and protects the solder joints against mechanical stress.
- Available with 1.5 mm or 3.2 mm solder pins.
- The short 1.5 mm pins enable a double-sided PCB mounting and reduce the needed amount of solder paste without losing holding force to the PCB.
- Packed either in box (BX) or on anti-static roll (tape-on-reel, RL).

### Product data

IEC: 400 V / 27.5 A  
UL: 300 V / 18.5 A



For additional articles and information, refer to [catalog.weidmuller.com](http://catalog.weidmuller.com)

#### Note:

- Additional colours on request
- Gold-plated contact surfaces on request
- Rated current related to rated cross-section & min. No. of poles.
- Diameter of solder eyelet  $D = 1.4 + 0.1 \text{ mm}$
- Solder eyelet diameter  $D = 1.5 + 0.1 \text{ mm}$ , from 9 poles
- P on drawing = pitch
- Rated data refer only to the component itself. Clearance and creepage distances to other components are to be designed in accordance with the relevant application standards.

### SL-SMT 5.08HC/./90 Box

#### Packaged in box



#### Dimensioned drawing

## G

### Technical data

In compliance with IEC 60664-1 / IEC 61984			
Clamping range, max.			
<b>Solid core H05(07) V-U</b>			
Stranded H07 V-R			
Flexible H05(07) V-K			
Flexible with ferrule			
Ferrule with plastic collar			
Stripping length			
Screwdriver blade	mm		
According to norm			
Tightening torque range			
<b>Rated current, max.</b>	<b>A</b>	<b>27.5</b>	<b>24</b>
At ambient temperature		20°C	40°C
For conductor cross-section			
Overvoltage category		III	III II
Pollution severity		3	2 2
<b>Rated voltage</b>	<b>V</b>	<b>250</b>	<b>320 400</b>
Rated impulse voltage	kV	4	4 4
<b>UL / CUL (Use Group)</b>		<b>B</b>	<b>C D</b>
<b>Rated voltage</b>	<b>V</b>	<b>300</b>	<b>300</b>
<b>Rated current</b>	<b>A</b>	<b>18.5</b>	<b>10</b>
<b>AWG conductor</b>	<b>AWG</b>		-
<b>CSA (Use Group)</b>		<b>B</b>	<b>C D</b>
Rated voltage	V	300	300
Rated current	A	18.5	18.5
AWG conductor	AWG		-
General data			
Type of insulation material		LCP GF	
UL 94 flammability rating		V-0	
Contact base material		CuMg	
Material of contact surface		tinned	
Pin dimensions = d	mm	1.2, Octagonal	
Solder eyelet Ø = D	mm	1.4	
Solder eyelet Ø tolerance	mm	+ 0,1	

### Accessories

Note: Refer to the Accessories chapter for additional accessories.

Coding	Order No.
BLZ/SL KO OR BX	<b>1573010000</b>
BLZ/SL KO BK BX	<b>1545710000</b>
Partition element	
SL AT OR	<b>1598300000</b>
SL AT SW	<b>1770240000</b>
LED light guide	
SL FLA 1.5/1	<b>1580100000</b>
SL FLA 2,3/1	<b>1636670000</b>
SL FLA 2,3/24	<b>1636680000</b>
SL FLA 3,8/1	<b>1580110000</b>
SL FLA 9,0/1	<b>1580120000</b>

### Ordering data

Solder pin length		3.2 mm		
Colour		Black		
Pitch	5.08 mm			
Pol.	L1	(inch)	Qty.	Order No.
2	5.08	0.200	100	<b>1779950000</b>
3	10.16	0.400	100	<b>1779960000</b>
4	15.24	0.600	100	<b>1779970000</b>
5	20.32	0.800	50	<b>1779980000</b>
6	25.40	1.000	50	<b>1779990000</b>
7	30.48	1.200	50	<b>1780000000</b>
8	35.56	1.400	50	<b>1780010000</b>
9	40.64	1.600	50	<b>1780020000</b>
10	45.72	1.800	50	<b>1780030000</b>
11	50.80	2.000	50	<b>1780040000</b>
12	55.88	2.200	50	<b>1780050000</b>
13	60.96	2.400	50	<b>1780060000</b>
14	66.04	2.600	50	<b>1780070000</b>
15	71.12	2.800	50	<b>1780080000</b>
16	76.20	3.000	50	<b>1780090000</b>
17	81.28	3.200	20	<b>1780100000</b>
18	86.36	3.400	20	<b>1780110000</b>
19	91.44	3.600	20	<b>1780120000</b>
20	96.52	3.800	20	<b>1780130000</b>
21	101.60	4.000	20	<b>1780140000</b>
22	106.68	4.200	20	<b>1780150000</b>
23	111.76	4.400	20	<b>1780160000</b>
24	116.84	4.600	20	<b>1780170000</b>



### SL-SMT 5.08HC../90 Tape

Tape-on-reel



Dimensioned drawing

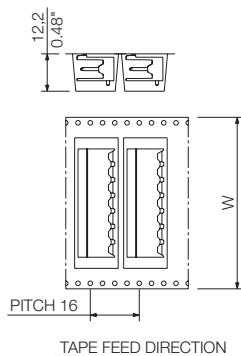

#### Ordering data

Solder pin length		1.5 mm			
Colour		Black			
Pitch		5.08 mm			
Pol.	L1	(inch)	Qty.	Order No.	
2	5.08	0.200	350	1821160000	
3	10.16	0.400	350	1821170000	
4	15.24	0.600	350	1774784001	
5	20.32	0.800	350	1774794001	
6	25.40	1.000	350	1774804001	
7	30.48	1.200	350	1774814001	
8	35.56	1.400	350	1774824001	

Tape widths: 32, 44, 56, 72, 88

### SL-SMT 5.08HC../90G Box

Packaged in box



Dimensioned drawing

#### Ordering data

Solder pin length		3.2 mm			
Colour		Black			
Pitch		5.08 mm			
Pol.	L1	(inch)	Qty.	Order No.	
2	5.08	0.200	100	1780180000	
3	10.16	0.400	100	1780190000	
4	15.24	0.600	100	1780200000	
5	20.32	0.800	50	1780210000	
6	25.40	1.000	50	1780220000	
7	30.48	1.200	50	1780230000	
8	35.56	1.400	50	1780240000	
9	40.64	1.600	50	1780250000	
10	45.72	1.800	50	1780260000	
11	50.80	2.000	50	1780270000	
12	55.88	2.200	50	1780280000	
13	60.96	2.400	50	1780290000	
14	66.04	2.600	50	1780300000	
15	71.12	2.800	50	1780310000	
16	76.20	3.000	50	1780320000	
17	81.28	3.200	20	1780330000	
18	86.36	3.400	20	1780340000	
19	91.44	3.600	20	1780350000	
20	96.52	3.800	20	1780360000	
21	101.60	4.000	20	1780370000	
22	106.68	4.200	20	1780380000	
23	111.76	4.400	20	1780390000	
24	116.84	4.600	20	1780400000	

### SL-SMT 5.08HC../90G Tape

Tape-on-reel



Dimensioned drawing

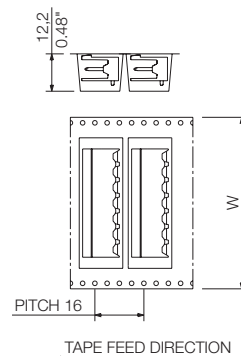

#### Ordering data

Solder pin length		1.5 mm			
Colour		Black			
Pitch		5.08 mm			
Pol.	L1	(inch)	Qty.	Order No.	
2	5.08	0.200	350	1821140000	
3	10.16	0.400	350	1775014001	
4	15.24	0.600	350	1775024001	
5	20.32	0.800	350	1775034001	
6	25.40	1.000	350	1775044001	
7	30.48	1.200	350	1775054001	

Tape widths: 32, 44, 56, 72, 88

## Connectors in 5.08 mm pitch Series BL/SL 5.08

### SL-SMT 5.08HC../90

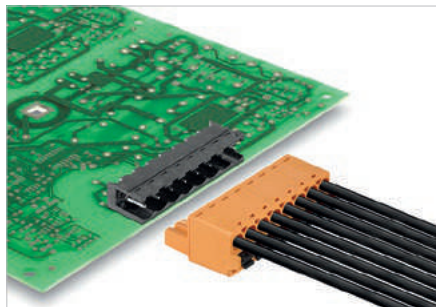

High-temperature-resistant, 90°-angled male header, optimised for SMT processing. The male headers can be manually coded or ordered as pre-coded headers.

- Available in open, closed (G), with screw flange (F) or with solder flange (LF).
- The solder flange substitutes a screw fastening to the PCB and protects the solder joints against mechanical stress.
- Available with 1.5 mm or 3.2 mm solder pins.
- The short 1.5 mm pins enable a double-sided PCB mounting and reduce the needed amount of solder paste without losing holding force to the PCB.
- Packed either in box (BX) or on anti-static roll (tape-on-reel, RL).

### Product data

IEC: 400 V / 27.5 A  
UL: 300 V / 18.5 A



For additional articles and information, refer to [catalog.weidmuller.com](http://catalog.weidmuller.com)

#### Note:

- Gold-plated contact surfaces on request
- Rated current related to rated cross-section & min. No. of poles.
- Diameter of solder eyelet  $D = 1.4 \pm 0.1$  mm
- Solder eyelet diameter  $D = 1.5 \pm 0.1$  mm, from 9 poles
- P on drawing = pitch
- Rated data refer only to the component itself. Clearance and creepage distances to other components are to be designed in accordance with the relevant application standards.

### SL-SMT 5.08HC../90F Box

#### Packaged in box



#### Dimensioned drawing

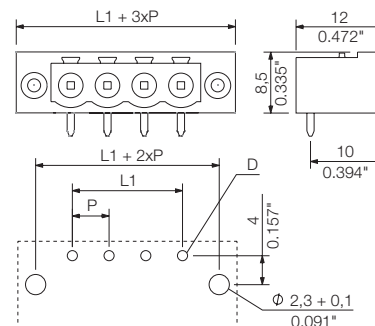

### Technical data

#### In compliance with IEC 60664-1 / IEC 61984

Clamping range, max.			
<b>Solid core H05(07) V-U</b>			
Stranded H07 V-R			
Flexible H05(07) V-K			
Flexible with ferrule			
Ferrule with plastic collar			
Stripping length			
Screwdriver blade	mm		
According to norm			
Tightening torque range			
<b>Rated current, max.</b>	<b>A</b>	<b>27.5</b>	<b>24</b>
At ambient temperature		20°C	40°C
For conductor cross-section			
Overvoltage category		III	III
Pollution severity		3	2
<b>Rated voltage</b>	<b>V</b>	<b>250</b>	<b>320</b>
Rated impulse voltage	kV	4	4
<b>UL / CUL (Use Group)</b>	<b>B</b>	<b>C</b>	<b>D</b>
<b>Rated voltage</b>	<b>V</b>	<b>300</b>	<b>300</b>
<b>Rated current</b>	<b>A</b>	<b>18.5</b>	<b>10</b>
<b>AWG conductor</b>	<b>AWG</b>	-	-
<b>CSA (Use Group)</b>	<b>B</b>	<b>C</b>	<b>D</b>
Rated voltage	V	300	300
Rated current	A	18.5	18.5
AWG conductor	AWG	-	-
<b>General data</b>			
Type of insulation material	LCP GF		
UL 94 flammability rating	V-0		
Contact base material	CuMg		
Material of contact surface	tinned		
Pin dimensions = d	mm	1.2, Octagonal	
Solder eyelet Ø = D	mm	1.5	
Solder eyelet Ø tolerance	mm	+ 0,1	

### Accessories

Note: Refer to the Accessories chapter for additional accessories.

Coding	Order No.
BLZ/SL KO OR BX	<b>1573010000</b>
BLZ/SL KO BK BX	<b>1545710000</b>
<b>Partition element</b>	
SL AT OR	<b>1598300000</b>
SL AT SW	<b>1770240000</b>
<b>LED light guide</b>	
SL FLA 1.5/1	<b>1580100000</b>
SL FLA 2,3/1	<b>1636670000</b>
SL FLA 2,3/24	<b>1636680000</b>
SL FLA 3,8/1	<b>1580110000</b>
SL FLA 9,0/1	<b>1580120000</b>

### Ordering data

Solder pin length		3.2 mm		
Colour		Black		
Pitch	5.08 mm			
Pol.	L1	(inch)	Qty.	Order No.
2	5.08	0.200	90	<b>1837630000</b>
3	10.16	0.400	72	<b>1837640000</b>
4	15.24	0.600	60	<b>1837650000</b>
5	20.32	0.800	48	<b>1837660000</b>
6	25.40	1.000	42	<b>1837670000</b>
7	30.48	1.200	36	<b>1837680000</b>
8	35.56	1.400	36	<b>1837690000</b>
9	40.64	1.600	30	<b>1837700000</b>
10	45.72	1.800	30	<b>1837710000</b>
11	50.80	2.000	24	<b>1837720000</b>
12	55.88	2.200	24	<b>1837730000</b>
13	60.96	2.400	24	<b>1837740000</b>
14	66.04	2.600	18	<b>1837750000</b>
15	71.12	2.800	18	<b>1837760000</b>
16	76.20	3.000	18	<b>1837770000</b>
17	81.28	3.200	18	<b>1837780000</b>
18	86.36	3.400	18	<b>1837790000</b>
19	91.44	3.600	12	<b>1837800000</b>
20	96.52	3.800	12	<b>1837810000</b>
21	101.60	4.000	12	<b>1837820000</b>
22	106.68	4.200	12	<b>1837830000</b>
23	111.76	4.400	12	<b>1837840000</b>
24	116.84	4.600	12	<b>1837850000</b>



## Connectors in 5.08 mm pitch Series BL/SL 5.08

### SL-SMT 5.08HC../90

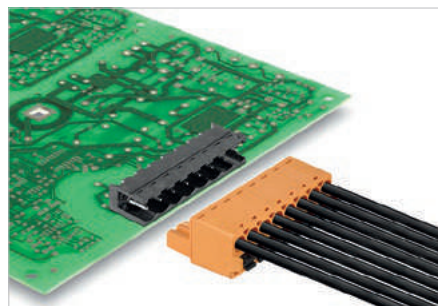

High-temperature-resistant, 90°-angled male header, optimised for SMT processing. The male headers can be manually coded or ordered as pre-coded headers.

- Available in open, closed (G), with screw flange (F) or with solder flange (LF).
- The solder flange substitutes a screw fastening to the PCB and protects the solder joints against mechanical stress.
- Available with 1.5 mm or 3.2 mm solder pins.
- The short 1.5 mm pins enable a double-sided PCB mounting and reduce the needed amount of solder paste without losing holding force to the PCB.
- Packed either in box (BX) or on anti-static roll (tape-on-reel, RL).

### Product data

IEC: 400 V / 27.5 A  
UL: 300 V / 18.5 A



For additional articles and information, refer to [catalog.weidmueller.com](http://catalog.weidmueller.com)

#### Note:

- Gold-plated contact surfaces on request
- Rated current related to rated cross-section & min. No. of poles.
- P on drawing = pitch
- Rated data refer only to the component itself. Clearance and creepage distances to other components are to be designed in accordance with the relevant application standards.

### SL-SMT 5.08HC../90LF Box

Packaged in box; with solder flange



#### Dimensioned drawing

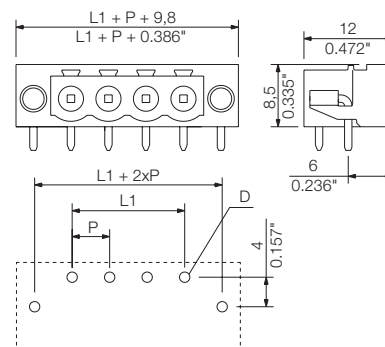

### Technical data

#### In compliance with IEC 60664-1 / IEC 61984

Clamping range, max.			
<b>Solid core H05(07) V-U</b>			
Stranded H07 V-R			
Flexible H05(07) V-K			
Flexible with ferrule			
Ferrule with plastic collar			
Stripping length			
Screwdriver blade	mm		
According to norm			
Tightening torque range			
<b>Rated current, max.</b>	<b>A</b>	<b>27.5</b>	<b>24</b>
At ambient temperature		20°C	40°C
For conductor cross-section			
Overvoltage category		III	III II
Pollution severity		3	2 2
<b>Rated voltage</b>	<b>V</b>	<b>250</b>	<b>320 400</b>
Rated impulse voltage	kV	4	4 4
<b>UL / CUL (Use Group)</b>	<b>B C D</b>		
<b>Rated voltage</b>	<b>V</b>	<b>300</b>	<b>300</b>
<b>Rated current</b>	<b>A</b>	<b>18.5</b>	<b>10</b>
<b>AWG conductor</b>	<b>AWG</b>	-	
<b>CSA (Use Group)</b>	<b>B C D</b>		
Rated voltage	V	300	300
Rated current	A	18.5	18.5
AWG conductor	AWG	-	
<b>General data</b>			
Type of insulation material	LCP GF		
UL 94 flammability rating	V-0		
Contact base material	CuMg		
Material of contact surface	tinned		
Pin dimensions = d	mm	1.2, Octagonal	
Solder eyelet Ø = D	mm	1.5	
Solder eyelet Ø tolerance	mm	+ 0,1	

### Accessories

Note: Refer to the Accessories chapter for additional accessories.

Coding	Order No.
BLZ/SL KO OR BX	<b>1573010000</b>
BLZ/SL KO BK BX	<b>1545710000</b>
<b>Partition element</b>	
SL AT OR	<b>1598300000</b>
SL AT SW	<b>1770240000</b>
<b>LED light guide</b>	
SL FLA 1.5/1	<b>1580100000</b>
SL FLA 2,3/1	<b>1636670000</b>
SL FLA 2,3/24	<b>1636680000</b>
SL FLA 3,8/1	<b>1580110000</b>
SL FLA 9,0/1	<b>1580120000</b>

### Ordering data

Solder pin length		3.2 mm		
Colour		Black		
Pitch	5.08 mm			
Pol.	L1	(inch)	Qty.	Order No.
2	5.08	0.200	90	<b>1780410000</b>
3	10.16	0.400	72	<b>1780420000</b>
4	15.24	0.600	60	<b>1780430000</b>
5	20.32	0.800	48	<b>1780440000</b>
6	25.40	1.000	42	<b>1780450000</b>
7	30.48	1.200	36	<b>1780460000</b>
8	35.56	1.400	36	<b>1780470000</b>
9	40.64	1.600	30	<b>1780480000</b>
10	45.72	1.800	30	<b>1780490000</b>
11	50.80	2.000	24	<b>1780500000</b>
12	55.88	2.200	24	<b>1780510000</b>
13	60.96	2.400	24	<b>1780540000</b>
14	66.04	2.600	50	<b>1780550000</b>
15	71.12	2.800	50	<b>1780560000</b>
16	76.20	3.000	18	<b>1780570000</b>
17	81.28	3.200	18	<b>1780580000</b>
18	86.36	3.400	18	<b>1780590000</b>
19	91.44	3.600	12	<b>1780600000</b>
20	96.52	3.800	12	<b>1780610000</b>
21	101.60	4.000	12	<b>1780620000</b>
22	106.68	4.200	12	<b>1780630000</b>
23	111.76	4.400	12	<b>1780640000</b>
24	116.84	4.600	12	<b>1780650000</b>

### SL-SMT 5.08HC/./90LF Tape

Tape-on-reel; with solder flange



Dimensioned drawing

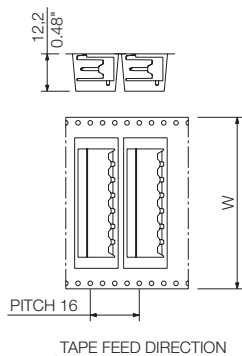

### Solder flange (LF)

Normally you use a pin header with fastening flanges (F) in combination with a screw from the rear side of the PCB to increase the fixation forces of the pin headers. The disadvantages are additional process steps that make the PCB mounting complex and cost intensive. The patented solder flange was designed to solve exactly this problem and find a simple and cheap solution. The additional solder pins substitute the present screw flanges and they get soldered together with the pin header. This terminates additional process steps and thus reduces production costs. The additional fixation protects the soldered connections from tensile strain and avoids permanent mechanical stress such as caused by the post-fastened screw forces.

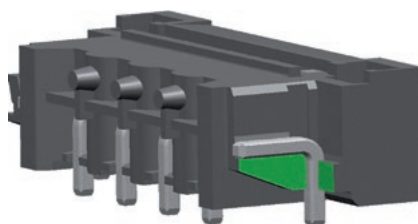

### Ordering data

Solder pin length		1.5 mm	
Colour		Black	
Pitch		5.08 mm	
Pol.	L1	(inch)	Qty. Order No.
2	5.08	0.200	350 1775234001
3	10.16	0.400	350 1775244001
4	15.24	0.600	350 1775254001
5	20.32	0.800	350 1775264001
6	25.40	1.000	350 1775274001

Tape widths: 32, 44, 56, 72, 88

## Connectors in 5.08 mm pitch Series BL/SL 5.08

### SL-SMT 5.08HC../180

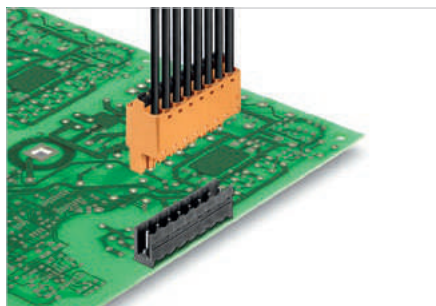

High-temperature-resistant, 180°-angled male header, optimised for SMT processing. The male headers can be manually coded or ordered as pre-coded headers.

- Available in open, closed (G), with screw flange (F) or with solder flange (LF).
- The solder flange substitutes a screw fastening to the PCB and protects the solder joints against mechanical stress.
- Available with 1.5 mm or 3.2 mm solder pins.
- The short 1.5 mm pins enable a double-sided PCB mounting and reduce the needed amount of solder paste without losing holding force to the PCB.
- Packed either in box (BX) or on anti-static roll (tape-on-reel, RL).

### Product data

IEC: 400 V / 27.5 A  
UL: 300 V / 18.5 A



For additional articles and information, refer to [catalog.weidmueller.com](http://catalog.weidmueller.com)

#### Note:

- Gold-plated contact surfaces on request
- Rated current related to rated cross-section & min. No. of poles.
- Diameter of solder eyelet  $D = 1.4 \pm 0.1$  mm
- Solder eyelet diameter  $D = 1.5 \pm 0.1$  mm, from 9 poles
- P on drawing = pitch
- Rated data refer only to the component itself. Clearance and creepage distances to other components are to be designed in accordance with the relevant application standards.

### SL-SMT 5.08HC../180 Box

#### Packaged in box



#### Dimensioned drawing

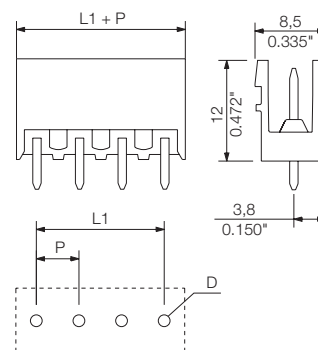

### Technical data

#### In compliance with IEC 60664-1 / IEC 61984

Clamping range, max.			
<b>Solid core H05(07) V-U</b>			
Stranded H07 V-R			
Flexible H05(07) V-K			
Flexible with ferrule			
Ferrule with plastic collar			
Stripping length			
Screwdriver blade	mm		
According to norm			
Tightening torque range			
<b>Rated current, max.</b>	<b>A</b>	<b>27.5</b>	<b>24</b>
At ambient temperature		20°C	40°C
For conductor cross-section			
Overvoltage category		III	III II
Pollution severity		3	2 2
<b>Rated voltage</b>	<b>V</b>	<b>250</b>	<b>320 400</b>
Rated impulse voltage	kV	4	4 4
<b>UL / CUL (Use Group)</b>		<b>B</b>	<b>C D</b>
<b>Rated voltage</b>	<b>V</b>	<b>300</b>	<b>300</b>
<b>Rated current</b>	<b>A</b>	<b>18.5</b>	<b>10</b>
<b>AWG conductor</b>	<b>AWG</b>		
<b>CSA (Use Group)</b>		<b>B</b>	<b>C D</b>
Rated voltage	V	300	300
Rated current	A		18.5
AWG conductor	AWG		
<b>General data</b>			
Type of insulation material		LCP GF	
UL 94 flammability rating		V-0	
Contact base material		CuMg	
Material of contact surface		tinned	
Pin dimensions = d	mm	1.2, Octagonal	
Solder eyelet Ø = D	mm	1.4	
Solder eyelet Ø tolerance	mm	+ 0,1	

### Accessories

Note: Refer to the Accessories chapter for additional accessories.

Coding	Order No.
BLZ/SL KO OR BX	<b>1573010000</b>
BLZ/SL KO BK BX	<b>1545710000</b>
Partition element	
SL AT OR	<b>1598300000</b>
SL AT SW	<b>1770240000</b>

### Ordering data

Solder pin length		3.2 mm		
Colour		Black		
Pitch	5.08 mm			
Pol.	L1	(inch)	Qty.	Order No.
2	5.08	0.200	100	<b>1837980000</b>
3	10.16	0.400	100	<b>1837990000</b>
4	15.24	0.600	100	<b>1838000000</b>
5	20.32	0.800	50	<b>1838010000</b>
6	25.40	1.000	50	<b>1838020000</b>
7	30.48	1.200	50	<b>1838030000</b>
8	35.56	1.400	50	<b>1838040000</b>
9	40.64	1.600	50	<b>1838050000</b>
10	45.72	1.800	50	<b>1838060000</b>
11	50.80	2.000	50	<b>1838070000</b>
12	55.88	2.200	50	<b>1838080000</b>
13	60.96	2.400	50	<b>1838090000</b>
14	66.04	2.600	50	<b>1838100000</b>
15	71.12	2.800	50	<b>1838110000</b>
16	76.20	3.000	50	<b>1838120000</b>
17	81.28	3.200	20	<b>1838130000</b>
18	86.36	3.400	20	<b>1838140000</b>
19	91.44	3.600	20	<b>1838150000</b>
20	96.52	3.800	20	<b>1838160000</b>
21	101.60	4.000	20	<b>1838170000</b>
22	106.68	4.200	20	<b>1838180000</b>
23	111.76	4.400	20	<b>1838190000</b>
24	116.84	4.600	20	<b>1838200000</b>

### SL-SMT 5.08HC../180 Tape

Tape-on-reel



Dimensioned drawing

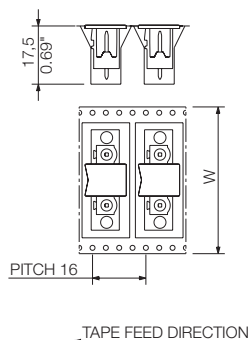

#### Ordering data

Solder pin length		1.5 mm		
Colour		Black		
Pitch		5.08 mm		
Pol.	L1	(inch)	Qty.	Order No.
2	5.08	0.200	250	1821100000
3	10.16	0.400	250	1821110000
4	15.24	0.600	250	1775594001
5	20.32	0.800	250	1775634001
6	25.40	1.000	250	1775644001
7	30.48	1.200	250	1775654001
8	35.56	1.400	250	1775664001

Tape widths: 32, 44, 56, 72, 88

### SL-SMT 5.08HC../180G Box

Packaged in box



Dimensioned drawing

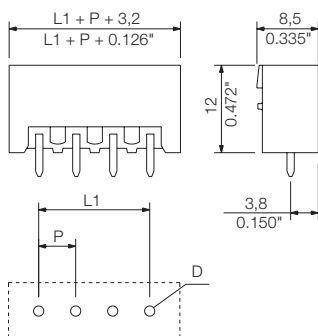

#### Ordering data

Solder pin length		3.2 mm		
Colour		Black		
Pitch		5.08 mm		
Pol.	L1	(inch)	Qty.	Order No.
2	5.08	0.200	100	1838210000
3	10.16	0.400	100	1838220000
4	15.24	0.600	100	1838230000
5	20.32	0.800	50	1838240000
6	25.40	1.000	50	1838250000
7	30.48	1.200	50	1838260000
8	35.56	1.400	50	1838270000
9	40.64	1.600	50	1838280000
10	45.72	1.800	50	1838290000
11	50.80	2.000	50	1838300000
12	55.88	2.200	50	1838310000
13	60.96	2.400	50	1838320000
14	66.04	2.600	50	1838330000
15	71.12	2.800	50	1838340000
16	76.20	3.000	50	1838350000
17	81.28	3.200	20	1838360000
18	86.36	3.400	20	1838370000
19	91.44	3.600	20	1838380000
20	96.52	3.800	20	1838390000
21	101.60	4.000	20	1838400000
22	106.68	4.200	20	1838410000
23	111.76	4.400	20	1838420000
24	116.84	4.600	20	1838430000

### SL-SMT 5.08HC../180G Tape

Tape-on-reel



Dimensioned drawing

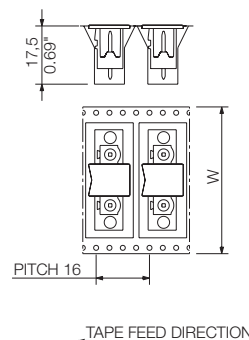

#### Ordering data

Solder pin length		1.5 mm		
Colour		Black		
Pitch		5.08 mm		
Pol.	L1	(inch)	Qty.	Order No.
2	5.08	0.200	250	1820170000
3	10.16	0.400	250	1775934001
4	15.24	0.600	250	1775944001
5	20.32	0.800	250	1775954001
6	25.40	1.000	250	1775964001
7	30.48	1.200	250	1775974001

Tape widths: 32, 44, 56, 72, 88

## Connectors in 5.08 mm pitch Series BL/SL 5.08

### SL-SMT 5.08HC/./180

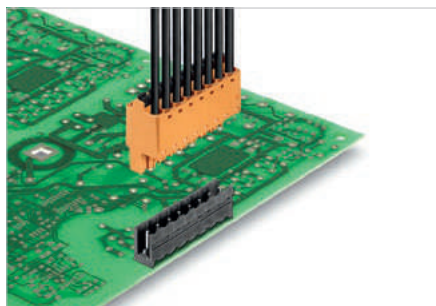

High-temperature-resistant, 180°-angled male header, optimised for SMT processing. The male headers can be manually coded or ordered as pre-coded headers.

- Available in open, closed (G), with screw flange (F) or with solder flange (LF).
- The solder flange substitutes a screw fastening to the PCB and protects the solder joints against mechanical stress.
- Available with 1.5 mm or 3.2 mm solder pins.
- The short 1.5 mm pins enable a double-sided PCB mounting and reduce the needed amount of solder paste without losing holding force to the PCB.
- Packed either in box (BX) or on anti-static roll (tape-on-reel, RL).

### Product data

IEC: 400 V / 27.5 A  
UL: 300 V / 18.5 A



For additional articles and information, refer to [catalog.weidmueller.com](http://catalog.weidmueller.com)

#### Note:

- Gold-plated contact surfaces on request
- Rated current related to rated cross-section & min. No. of poles.
- Diameter of solder eyelet  $D = 1.4 \pm 0.1$  mm
- Solder eyelet diameter  $D = 1.5 \pm 0.1$  mm, from 9 poles
- P on drawing = pitch
- Rated data refer only to the component itself. Clearance and creepage distances to other components are to be designed in accordance with the relevant application standards.

### SL-SMT 5.08HC/./180F Box

#### Packaged in box



#### Dimensioned drawing

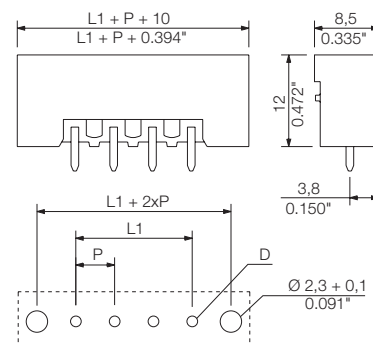

### Technical data

#### In compliance with IEC 60664-1 / IEC 61984

Clamping range, max.			
<b>Solid core H05(07) V-U</b>			
Stranded H07 V-R			
Flexible H05(07) V-K			
Flexible with ferrule			
Ferrule with plastic collar			
Stripping length			
Screwdriver blade	mm		
According to norm			
Tightening torque range			
<b>Rated current, max.</b>	<b>A</b>	<b>27.5</b>	<b>24</b>
At ambient temperature		20°C	40°C
For conductor cross-section		III	III II
Overtoltage category		3	2 2
Pollution severity		3	2 2
<b>Rated voltage</b>	<b>V</b>	<b>250</b>	<b>320 400</b>
Rated impulse voltage	kV	4	4 4
<b>UL / CUL (Use Group)</b>	<b>B C D</b>		
<b>Rated voltage</b>	<b>V</b>	<b>300</b>	<b>300</b>
<b>Rated current</b>	<b>A</b>	<b>18.5</b>	<b>10</b>
<b>AWG conductor</b>	<b>AWG</b>	-	
<b>CSA (Use Group)</b>	<b>B C D</b>		
Rated voltage	V	300	300
Rated current	A		18.5
AWG conductor	AWG	-	
<b>General data</b>			
Type of insulation material		LCP GF	
UL 94 flammability rating		V-0	
Contact base material		CuMg	
Material of contact surface		tinned	
Pin dimensions = d	mm	1.2, Octagonal	
Solder eyelet Ø = D	mm	1.4	
Solder eyelet Ø tolerance	mm	+ 0,1	

### Accessories

Note: Refer to the Accessories chapter for additional accessories.

Coding	Order No.
BLZ/SL KO OR BX	<b>1573010000</b>
BLZ/SL KO BK BX	<b>1545710000</b>
Partition element	
SL AT OR	<b>1598300000</b>
SL AT SW	<b>1770240000</b>

### Ordering data

Solder pin length		3.2 mm		
Colour		Black		
Pitch	5.08 mm			
Pol.	L1	(inch)	Qty.	Order No.
2	5.08	0.200	90	<b>1837860000</b>
3	10.16	0.400	72	<b>1820600000</b>
4	15.24	0.600	60	<b>1837870000</b>
5	20.32	0.800	48	<b>1820770000</b>
6	25.40	1.000	42	<b>1820610000</b>
7	30.48	1.200	36	<b>1837880000</b>
8	35.56	1.400	36	<b>1820620000</b>
9	40.64	1.600	30	<b>1837890000</b>
10	45.72	1.800	30	<b>1820780000</b>
11	50.80	2.000	24	<b>1837900000</b>
12	55.88	2.200	24	<b>1820630000</b>
13	60.96	2.400	24	<b>1820790000</b>
14	66.04	2.600	18	<b>1820800000</b>
15	71.12	2.800	18	<b>1837910000</b>
16	76.20	3.000	18	<b>1820640000</b>
17	81.28	3.200	18	<b>1837920000</b>
18	86.36	3.400	18	<b>1820650000</b>
19	91.44	3.600	12	<b>1837930000</b>
20	96.52	3.800	12	<b>1820810000</b>
21	101.60	4.000	12	<b>1837940000</b>
22	106.68	4.200	12	<b>1837950000</b>
23	111.76	4.400	12	<b>1837960000</b>
24	116.84	4.600	12	<b>1837970000</b>





## Connectors in 5.08 mm pitch Series BL/SL 5.08

### SL-SMT 5.08HC/./180

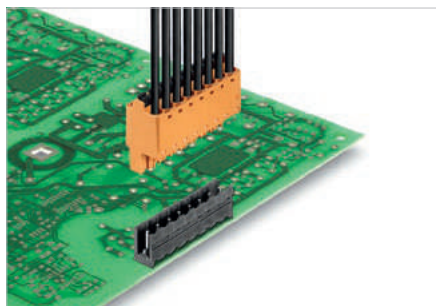

High-temperature-resistant, 180°-angled male header, optimised for SMT processing. The male headers can be manually coded or ordered as pre-coded headers.

- Available in open, closed (G), with screw flange (F) or with solder flange (LF).
- The solder flange substitutes a screw fastening to the PCB and protects the solder joints against mechanical stress.
- Available with 1.5 mm or 3.2 mm solder pins.
- The short 1.5 mm pins enable a double-sided PCB mounting and reduce the needed amount of solder paste without losing holding force to the PCB.
- Packed either in box (BX) or on anti-static roll (tape-on-reel, RL).

### Technical data

In compliance with IEC 60664-1 / IEC 61984			
Clamping range, max.			
<b>Solid core H05(07) V-U</b>			
Stranded H07 V-R			
Flexible H05(07) V-K			
Flexible with ferrule			
Ferrule with plastic collar			
Stripping length			
Screwdriver blade	mm		
According to norm			
Tightening torque range			
<b>Rated current, max.</b>	<b>A</b>	<b>27.5</b>	<b>24</b>
At ambient temperature		20°C	40°C
For conductor cross-section			
Overtoltage category		III	III II
Pollution severity		3	2 2
<b>Rated voltage</b>	<b>V</b>	<b>250</b>	<b>320 400</b>
Rated impulse voltage	kV	4	4 4
<b>UL / CUL (Use Group)</b>		<b>B</b>	<b>C D</b>
<b>Rated voltage</b>	<b>V</b>	<b>300</b>	<b>300</b>
<b>Rated current</b>	<b>A</b>	<b>18.5</b>	<b>10</b>
<b>AWG conductor</b>	<b>AWG</b>		
<b>CSA (Use Group)</b>		<b>B</b>	<b>C D</b>
Rated voltage	V	300	300
Rated current	A		18.5
AWG conductor	AWG		
General data			
Type of insulation material		LCP GF	
UL 94 flammability rating		V-0	
Contact base material		CuMg	
Material of contact surface		tinned	
Pin dimensions = d	mm	1.2, Octagonal	
Solder eyelet Ø = D	mm	1.5	
Solder eyelet Ø tolerance	mm	+ 0,1	

### Product data

IEC: 400 V / 27.5 A  
UL: 300 V / 18.5 A



For additional articles and information, refer to [catalog.weidmueller.com](http://catalog.weidmueller.com)

#### Note:

- Gold-plated contact surfaces on request
- Rated current related to rated cross-section & min. No. of poles.
- Diameter of solder eyelet  $D = 1.4 \pm 0.1$  mm
- Solder eyelet diameter  $D = 1.5 \pm 0.1$  mm, from 9 poles
- P on drawing = pitch
- Rated data refer only to the component itself. Clearance and creepage distances to other components are to be designed in accordance with the relevant application standards.

### SL-SMT 5.08HC/./180LF Box

Packaged in box; with solder flange



#### Dimensioned drawing

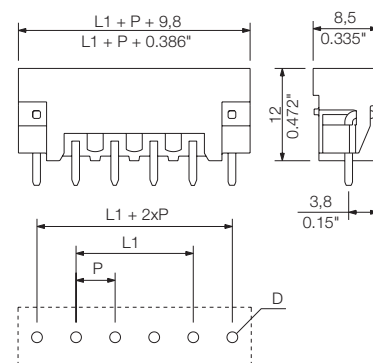

### Ordering data

Solder pin length		3.2 mm		
Colour		Black		
Pitch	5.08 mm			
Pol.	L1	(inch)	Qty.	Order No.
2	5.08	0.200	90	1838440000
3	10.16	0.400	72	1838450000
4	15.24	0.600	60	1838460000
5	20.32	0.800	48	1838470000
6	25.40	1.000	42	1838480000
7	30.48	1.200	36	1838490000
8	35.56	1.400	36	1838500000
9	40.64	1.600	30	1838510000
10	45.72	1.800	30	1838520000
11	50.80	2.000	24	1838530000
12	55.88	2.200	24	1838540000
13	60.96	2.400	24	1838550000
14	66.04	2.600	18	1838560000
15	71.12	2.800	18	1838570000
16	76.20	3.000	18	1838580000
17	81.28	3.200	18	1838590000
18	86.36	3.400	18	1838600000
19	91.44	3.600	12	1838610000
20	96.52	3.800	12	1838620000
21	101.60	4.000	12	1838630000
22	106.68	4.200	12	1838640000
23	111.76	4.400	12	1838650000
24	116.84	4.600	12	1838660000

### Accessories

Note: Refer to the Accessories chapter for additional accessories.

Coding	Order No.
BLZ/SL KO OR BX	1573010000
BLZ/SL KO BK BX	1545710000
Partition element	
SL AT OR	1598300000
SL AT SW	1770240000

### SL-SMT 5.08HC/./180LF Tape

Packaged in box; with solder flange



Dimensioned drawing

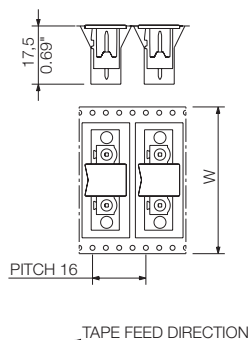

### Solder flange (LF)

Normally you use a pin header with fastening flanges (F) in combination with a screw from the rear side of the PCB to increase the fixation forces of the pin headers. The disadvantages are additional process steps that make the PCB mounting complex and cost intensive. The patented solder flange was designed to solve exactly this problem and find a simple and cheap solution. The additional solder pins substitute the present screw flanges and they get soldered together with the pin header. This terminates additional process steps and thus reduces production costs. The additional fixation protects the soldered connections from tensile strain and avoids permanent mechanical stress such as caused by the post-fastened screw forces.

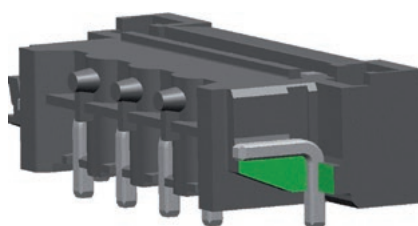

### Ordering data

Solder pin length		1.5 mm	
Colour		Black	
Pitch		5.08 mm	
Pol.	L1	(inch)	Qty. Order No.
2	5.08	0.200	250 <a href="#">1776364001</a>
3	10.16	0.400	250 <a href="#">1776374001</a>
4	15.24	0.600	250 <a href="#">1776384001</a>
5	20.32	0.800	250 <a href="#">1776394001</a>
6	25.40	1.000	250 <a href="#">1776404001</a>

Tape widths: 32, 44, 56, 72, 88

## Connectors in 5.08 mm pitch Series BL/SL 5.08

### SL-SMT 5.08HC/./270

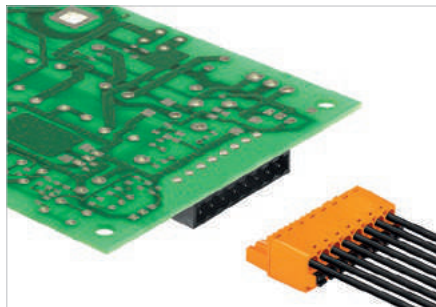

High-temperature-resistant, 270°-angled male connector, optimised for the SMT process. When using the flat-shaped version (L), a circuit board cut-out is required to accommodate the snap-on finger of the counterpart. There is no need for an extra screw connecting the circuit board when the solder flange version is used. This also protects the solder points from mechanical strain. As an option, the 1.5-mm short solder pins allow the PCB to be attached to both sides and minimise the need for solder paste. The male connectors can be manually coded or ordered as pre-coded connectors. Packaged in tape-on-reel or in a cardboard box.

### Technical data

#### In compliance with IEC 60664-1 / IEC 61984

Clamping range, max.			
<b>Solid core H05(07) V-U</b>			
Stranded H07 V-R			
Flexible H05(07) V-K			
Flexible with ferrule			
Ferrule with plastic collar			
Stripping length			
Screwdriver blade	mm		
According to norm			
Tightening torque range			
<b>Rated current, max.</b>	<b>A</b>	<b>27.5</b>	<b>24</b>
At ambient temperature		20°C	40°C
For conductor cross-section			
Overvoltage category		III	III II
Pollution severity		3	2 2
<b>Rated voltage</b>	<b>V</b>	<b>250</b>	<b>320 400</b>
Rated impulse voltage	kV	4	4 4
<b>UL / CUL (Use Group)</b>		<b>B</b>	<b>C D</b>
<b>Rated voltage</b>	<b>V</b>	<b>300</b>	<b>300</b>
<b>Rated current</b>	<b>A</b>	<b>18.5</b>	<b>10</b>
<b>AWG conductor</b>	<b>AWG</b>		
<b>CSA (Use Group)</b>		<b>B</b>	<b>C D</b>
Rated voltage	V	300	300
Rated current	A	18.5	18.5
AWG conductor	AWG		
<b>General data</b>			
Type of insulation material		LCP GF	
UL 94 flammability rating		V-0	
Contact base material		CuMg	
Material of contact surface		tinned	
Pin dimensions = d	mm	1.2, Octagonal	
Solder eyelet Ø = D	mm	1.4	
Solder eyelet Ø tolerance	mm	+ 0,1	

### Product data

IEC: 400 V / 27.5 A  
UL: 300 V / 18.5 A



For additional articles and information, refer to [catalog.weidmuller.com](http://catalog.weidmuller.com)

#### Note:

- Gold-plated contact surfaces on request
- Rated current related to rated cross-section & min. No. of poles.
- P on drawing = pitch
- Rated data refer only to the component itself. Clearance and creepage distances to other components are to be designed in accordance with the relevant application standards.

### SL-SMT 5.08HC/./270GL Box

#### Packaged in box



#### Dimensioned drawing

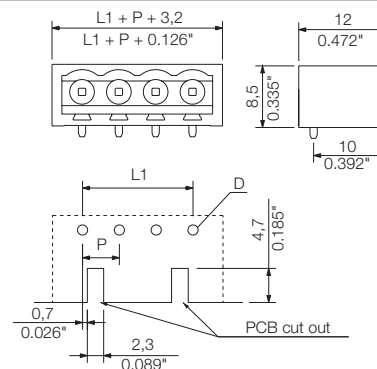

### Accessories

Note: Refer to the Accessories chapter for additional accessories.

Coding	Order No.
BLZ/SL KO OR BX	1573010000
BLZ/SL KO BK BX	1545710000
Partition element	
SL AT OR	1598300000
SL AT SW	1770240000

### Ordering data

Solder pin length		3.2 mm		
Colour		Black		
Pitch	5.08 mm			
Pol.	L1	(inch)	Qty.	Order No.
2	5.08	0.200	100	1877470000
3	10.16	0.400	100	1877490000
4	15.24	0.600	100	1877510000
5	20.32	0.800	50	1877520000
6	25.40	1.000	50	1877530000
7	30.48	1.200	50	1877540000
8	35.56	1.400	50	1877550000

### SL-SMT 5.08HC/./270GL Tape

Tape-on-reel



Dimensioned drawing

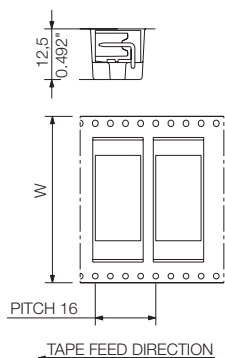

#### Ordering data

Solder pin length		1.5 mm			
Colour		Black			
Pitch		5.08 mm			
Pol.	L1	(inch)	Qty.	Order No.	
2	5.08	0.200	350	1877740000	
3	10.16	0.400	350	1877750000	
4	15.24	0.600	350	1877760000	
5	20.32	0.800	350	1877770000	
6	25.40	1.000	350	1877780000	
7	30.48	1.200	350	1877790000	
8	35.56	1.400	350	1877800000	

Tape widths: 32, 44, 56, 72, 88

### SL-SMT 5.08HC/./270GH Box

Packaged in box



Dimensioned drawing

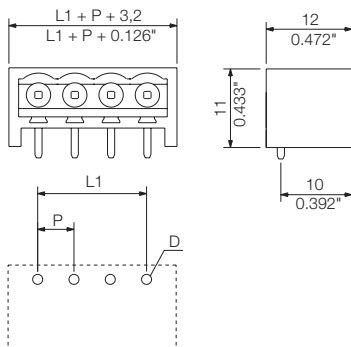

#### Ordering data

Solder pin length		3.2 mm			
Colour		Black			
Pitch		5.08 mm			
Pol.	L1	(inch)	Qty.	Order No.	
2	5.08	0.200	100	1877370000	
3	10.16	0.400	100	1877380000	
4	15.24	0.600	100	1877390000	
5	20.32	0.800	50	1877400000	
6	25.40	1.000	50	1877410000	
7	30.48	1.200	50	1877420000	
8	35.56	1.400	50	1877450000	

### SL-SMT 5.08HC/./270GH Tape

Tape-on-reel



Dimensioned drawing

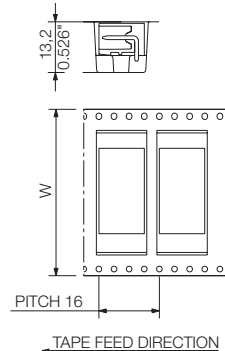

#### Ordering data

Solder pin length		1.5 mm			
Colour		Black			
Pitch		5.08 mm			
Pol.	L1	(inch)	Qty.	Order No.	
2	5.08	0.200	335	1877560000	
3	10.16	0.400	335	1877600000	
4	15.24	0.600	335	1877610000	
5	20.32	0.800	335	1877620000	
6	25.40	1.000	265	1877630000	
7	30.48	1.200	335	1877640000	
8	35.56	1.400	285	1877650000	

Tape widths: 32, 44, 56, 72, 88

G

## Connectors in 5.08 mm pitch Series BL/SL 5.08

### SL-SMT 5.08HC/./270

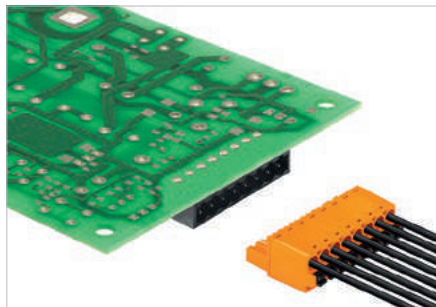

High-temperature-resistant, 270°-angled male connector, optimised for the SMT process. When using the flat-shaped version (L), a circuit board cut-out is required to accommodate the snap-on finger of the counterpart. There is no need for an extra screw connecting the circuit board when the solder flange version is used. This also protects the solder points from mechanical strain. As an option, the 1.5-mm short solder pins allow the PCB to be attached to both sides and minimise the need for solder paste. The male connectors can be manually coded or ordered as pre-coded connectors. Packaged in tape-on-reel or in a cardboard box.

### Technical data

#### In compliance with IEC 60664-1 / IEC 61984

Clamping range, max.			
<b>Solid core H05(07) V-U</b>			
Stranded H07 V-R			
Flexible H05(07) V-K			
Flexible with ferrule			
Ferrule with plastic collar			
Stripping length			
Screwdriver blade	mm		
According to norm			
Tightening torque range			
<b>Rated current, max.</b>	<b>A</b>	<b>27.5</b>	<b>24</b>
At ambient temperature		20°C	40°C
For conductor cross-section			
Overvoltage category		III	III II
Pollution severity		3	2 2
<b>Rated voltage</b>	<b>V</b>	<b>250</b>	<b>320 400</b>
Rated impulse voltage	kV	4	4 4
<b>UL / CUL (Use Group)</b>		<b>B</b>	<b>C D</b>
<b>Rated voltage</b>	<b>V</b>	<b>300</b>	<b>300</b>
<b>Rated current</b>	<b>A</b>	<b>18.5</b>	<b>10</b>
<b>AWG conductor</b>	<b>AWG</b>		-
<b>CSA (Use Group)</b>		<b>B</b>	<b>C D</b>
Rated voltage	V	300	300
Rated current	A	18.5	18.5
AWG conductor	AWG		-
<b>General data</b>			
Type of insulation material		LCP GF	
UL 94 flammability rating		V-0	
Contact base material		CuMg	
Material of contact surface		tinned	
Pin dimensions = d	mm	1.2, Octagonal	
Solder eyelet Ø = D	mm	1.4	
Solder eyelet Ø tolerance	mm	+ 0,1	

### Product data

IEC: 400 V / 27.5 A  
UL: 300 V / 18.5 A



For additional articles and information, refer to [catalog.weidmueller.com](http://catalog.weidmueller.com)

#### Note:

- Gold-plated contact surfaces on request
- Rated current related to rated cross-section & min. No. of poles.
- P on drawing = pitch
- Rated data refer only to the component itself. Clearance and creepage distances to other components are to be designed in accordance with the relevant application standards.

### SL-SMT 5.08HC/./270FL Box

Packaged in box; with solder flange



#### Dimensioned drawing

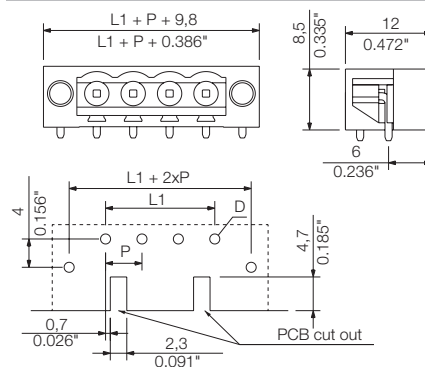

### Accessories

Note: Refer to the Accessories chapter for additional accessories.

Coding	Order No.
BLZ/SL KO OR BX	1573010000
BLZ/SL KO BK BX	1545710000
Partition element	
SL AT OR	1598300000
SL AT SW	1770240000

### Ordering data

Solder pin length		3.2 mm		
Colour		Black		
Pitch	5.08 mm			
Pol.	L1	(inch)	Qty.	Order No.
2	5.08	0.200	100	1876850000
3	10.16	0.400	100	1876860000
4	15.24	0.600	100	1876870000
5	20.32	0.800	50	1876880000
6	25.40	1.000	50	1876890000
7	30.48	1.200	50	1876900000
8	35.56	1.400	50	1876910000

### SL-SMT 5.08HC/./270FL Tape

Tape-on-reel; with solder flange



Dimensioned drawing

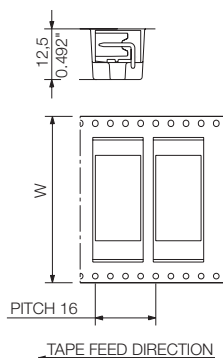

#### Ordering data

Solder pin length		1.5 mm			
Colour		Black			
Pitch		5.08 mm			
Pol.	L1	(inch)	Qty.	Order No.	
2	5.08	0.200	350	1876990000	
3	10.16	0.400	350	1877000000	
4	15.24	0.600	350	1877020000	
5	20.32	0.800	350	1877070000	
6	25.40	1.000	350	1877090000	
7	30.48	1.200	300	1877110000	
8	35.56	1.400	300	1877120000	

Tape widths: 32, 44, 56, 72, 88

### SL-SMT 5.08HC/./270FH Box

Packaged in box; with solder flange



Dimensioned drawing

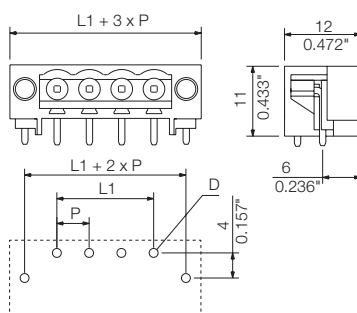

#### Ordering data

Solder pin length		3.2 mm			
Colour		Black			
Pitch		5.08 mm			
Pol.	L1	(inch)	Qty.	Order No.	
2	5.08	0.200	100	1877190000	
3	10.16	0.400	100	1877210000	
4	15.24	0.600	100	1877330000	
5	20.32	0.800	50	1877430000	
6	25.40	1.000	50	1877460000	
7	30.48	1.200	50	1877480000	
8	35.56	1.400	50	1877500000	

### SL-SMT 5.08HC/./270FH Tape

Tape-on-reel; with solder flange



Dimensioned drawing

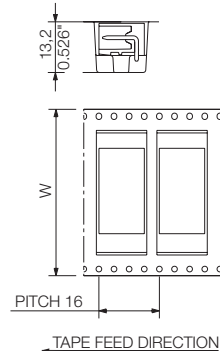

#### Ordering data

Solder pin length		1.5 mm			
Colour		Black			
Pitch		5.08 mm			
Pol.	L1	(inch)	Qty.	Order No.	
2	5.08	0.200	335	1876920000	
3	10.16	0.400	225	1876930000	
4	15.24	0.600	335	1876940000	
5	20.32	0.800	335	1876950000	
6	25.40	1.000	335	1876960000	
7	30.48	1.200	285	1876970000	
8	35.56	1.400	285	1876980000	

Tape widths: 32, 44, 56, 72, 88

## Connectors in 5.08 mm pitch Series BL/SL 5.08

### SL-SMaT 5.0xHC../90 & 180

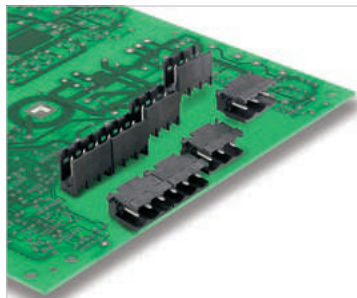

High-temperature-resistant, modular male header optimised for SMT processes Any desired size can be assembled by using 2- and 3-pole male header modules

- Higher processing speed with pick-and-place machines
- Fewer part numbers
- SL-SMaT covers pitches 5.00 and 5.08 mm
- Optimum utilisation of feeders through the need for just 2 belt conveyor systems
- Option for multi-pole male headers to be processed with pick-and-place machines
- No pick-and-place pads required - thus no need for tedious pad removal after soldering
- Packaged in tape-on-reel

### Product data

IEC: 400 V / 27.5 A  
UL: 300 V / 15 A



For additional articles and information, refer to [catalog.weidmueller.com](http://catalog.weidmueller.com)

#### Note:

- Gold-plated contact surfaces on request
- Rated current related to rated cross-section & min. No. of poles.
- P on drawing = pitch
- Rated data refer only to the component itself. Clearance and creepage distances to other components are to be designed in accordance with the relevant application standards.

### SL-SMaT 5.0xHC../90 Tape

#### Tape-on-reel



#### Dimensioned drawing

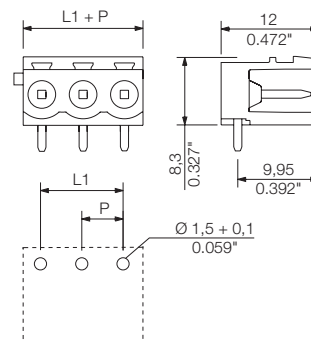

### Ordering data

Solder pin length		1.5 mm		
Colour		Black		
Pitch		5.00 mm		
Pol.	L1	(inch)	Qty.	Order No.
2	5.00	0.197	350	1812430000
3	10.00	0.394	350	1812440000

Tape widths: 32  
May be used for 5.00 and 5.08 mm pitches

## G

### Technical data

In compliance with IEC 60664-1 / IEC 61984			
Clamping range, max.			
<b>Solid core H05(07) V-U</b>			
Stranded H07 V-R			
Flexible H05(07) V-K			
Flexible with ferrule			
Ferrule with plastic collar			
Stripping length			
Screwdriver blade	mm		
According to norm			
Tightening torque range			
<b>Rated current, max.</b>	<b>A</b>	<b>27.5</b>	<b>24</b>
At ambient temperature		20°C	40°C
For conductor cross-section			
Overvoltage category		III	III II
Pollution severity		3	2 2
<b>Rated voltage</b>	<b>V</b>	<b>250</b>	<b>320 400</b>
Rated impulse voltage	kV	4	4 4
<b>UL / CUL (Use Group)</b>		<b>B</b>	<b>C D</b>
<b>Rated voltage</b>	<b>V</b>	<b>300</b>	<b>300</b>
<b>Rated current</b>	<b>A</b>	<b>15</b>	<b>10</b>
<b>AWG conductor</b>	<b>AWG</b>		-
<b>CSA (Use Group)</b>		<b>B</b>	<b>C D</b>
Rated voltage	V	300	300
Rated current	A	15	15
AWG conductor	AWG		-
<b>General data</b>			
Type of insulation material		LCP GF	
UL 94 flammability rating		V-0	
Contact base material		CuMg	
Material of contact surface		tinned	
Pin dimensions = d	mm	1.2, Octagonal	
Solder eyelet Ø = D	mm	1.4	
Solder eyelet Ø tolerance	mm	+ 0,1	

### Accessories

Note: Refer to the Accessories chapter for additional accessories.

Coding	Order No.
BLZ/SL KO OR BX	1573010000
BLZ/SL KO BK BX	1545710000
<b>Partition element</b>	
SL AT OR	1598300000
SL AT SW	1770240000
<b>LED light guide</b>	
SL FLA 1.5/1	1580100000
SL FLA 2,3/1	1636670000
SL FLA 2,3/24	1636680000
SL FLA 3.8/1	1580110000
SL FLA 9.0/1	1580120000

## 5.0x

## 90°



## SL-SMaRT 5.0xHC/./180 Tape

### Tape-on-reel



#### Dimensioned drawing

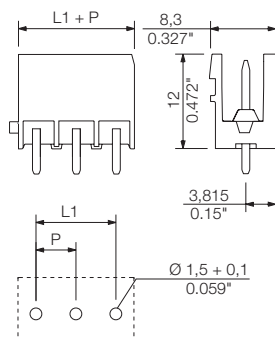

### Ordering data

Solder pin length		1.5 mm		
Colour		Black		
Pitch		5.00 mm		
Pol.	L1	(inch)	Qty.	Order No.
2	5.00	0.197	270	1812450000
3	10.00	0.394	270	1812460000

Tape widths: 32  
May be used for 5.00 and 5.08 mm pitches

## SL-SMaRT

The SL-SMaRT System was developed in order to bring even further improvements to the benefits of conventional SMT/THR components.

The aim was to satisfy the numerous demands of automatic PCB assembly.

The result is a male connector with the following features:

- Minimum weight
- Compact form
- Processing in automatic PCB assembly machines
- Maximum assembly speed
- Standardised automatic packing
- Space-saving feeding in automatic machines (feeder as narrow as possible)
- No pick&place pad required

Automatic PCB assembly machines operate most cost-effectively when they run at maximum speed.

This is not possible with heavy components.

The solution is to use 2- and 3-pole male connector modules to interconnect components of any size.

Therefore, by assembling the SL-SMaRT modules in one row, 23 standard male connectors (2- to 24-pole) can already be created.

The optimum tolerance design of the SL-SMaRT modules enables the use at pitches of 5.00 mm (0.197 inch) and 5.08 mm (0.200 inch).

The small pitch deviation is compensated for by the spacing to the next module.

The trick is that by using the appropriate hole layout, the number of standard male connectors replaced increases from 23 to 46 variations.

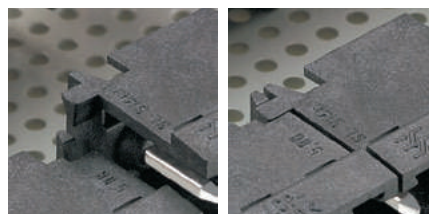

And the fact that two plug-in directions are available, 90° and 180°, means that the result is increased to 92 variations.

The optimum use of the feeder bank is possible thanks to the need for only four belt conveyor systems with a belt width of 32 mm each.

## Connectors in 5.08 mm pitch Series BL/SL 5.08

### SLDV-THR 5.08/././180

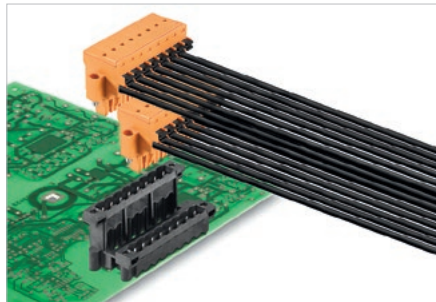

Double-level, high-temperature-resistant male header, optimised for SMT processing. The connection levels are offset and designed for a female plug with screw connection or "PUSH IN" wire connect. The male headers can be manually coded or ordered as pre-coded headers.

- Available with screw flange (F) or screw & solder flange (FLF).
- The solder flange makes an additional screw-fixation to the PCB unnecessary and protects the solder joints against mechanical stress.
- Available with 1.5 mm or 3.2 mm solder pins.
- The FLF version is featured with a soldering flange and an additional screw-fastening possibility to the PCB.

### Product data

IEC: 400 V / 15 A  
UL: 300 V / 10 A



For additional articles and information, refer to [catalog.weidmuller.com](http://catalog.weidmuller.com)

#### Note:

- Rated current related to rated cross-section & min. No. of poles.
- Spacing between rows: see hole layout
- P on drawing = pitch
- Rated data refer only to the component itself. Clearance and creepage distances to other components are to be designed in accordance with the relevant application standards.

### SLDV-THR 5.08/././180F

Packaged in box



#### Dimensioned drawing

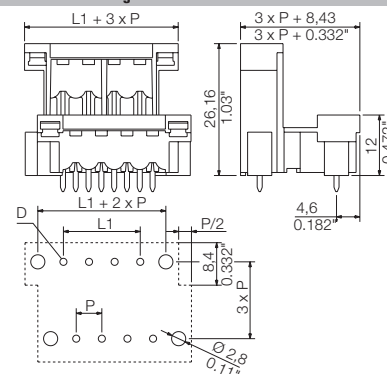

### Technical data

#### In compliance with IEC 60664-1 / IEC 61984

Clamping range, max.			
<b>Solid core H05(07) V-U</b>			
Stranded H07 V-R			
Flexible H05(07) V-K			
Flexible with ferrule			
Ferrule with plastic collar			
Stripping length			
Screwdriver blade	mm		
According to norm			
Tightening torque range			
<b>Rated current, max.</b>	<b>A</b>	<b>15</b>	<b>13</b>
At ambient temperature		20°C	40°C
For conductor cross-section		III	III II
Overtoltage category		3	2 2
Pollution severity		3	2 2
<b>Rated voltage</b>	<b>V</b>	<b>250</b>	<b>320 400</b>
Rated impulse voltage	kV	4	4 4
<b>UL / CUL (Use Group)</b>	<b>B C D</b>	<b>B C D</b>	<b>B C D</b>
<b>Rated voltage</b>	<b>V</b>	<b>300</b>	<b>300</b>
<b>Rated current</b>	<b>A</b>	<b>10</b>	<b>10</b>
<b>AWG conductor</b>	<b>AWG</b>		-
<b>CSA (Use Group)</b>	<b>B C D</b>	<b>B C D</b>	<b>B C D</b>
Rated voltage	V	300	300
Rated current	A	10	10
AWG conductor	AWG		-
<b>General data</b>			
Type of insulation material		LCP GF	
UL 94 flammability rating		V-0	
Contact base material		CuSn	
Material of contact surface		tinned	
Pin dimensions = d	mm	1.2, Octagonal	
Solder eyelet Ø = D	mm	1.4	
Solder eyelet Ø tolerance	mm	+ 0,1	

### Accessories

Note: Refer to the Accessories chapter for additional accessories.

Coding	Order No.
BLZ/SL KO OR BX	1573010000
BLZ/SL KO BK BX	1545710000
Partition element	Order No.
SL AT OR	1598300000
SL AT SW	1770240000

### Ordering data

Solder pin length		3.2 mm		
Colour		Black		
Pitch	5.08 mm			
Pol.	L1	(inch)	Qty.	Order No.
4	5.08	0.200	50	1828770000
6	10.16	0.400	50	1828780000
8	15.24	0.600	50	1828790000
10	20.32	0.800	50	1828800000
12	25.40	1.000	50	1828810000
14	30.48	1.200	20	1828820000
16	35.56	1.400	20	1828830000
18	40.64	1.600	20	1828840000
20	45.72	1.800	20	1828850000
22	50.80	2.000	10	1828860000
24	55.88	2.200	10	1828870000
26	60.96	2.400	10	1828880000
28	66.04	2.600	10	1889340000
30	71.12	2.800	10	1889350000
32	76.20	3.000	10	1866330000
34	81.28	3.200	10	1889360000
36	86.36	3.400	10	1889370000
38	91.44	3.600	10	1889380000
40	96.52	3.800	10	1889390000
42	101.60	4.000	10	1889400000
44	106.68	4.200	10	1889410000
46	111.76	4.400	10	1889420000
48	116.84	4.600	10	1889430000

## SLDV-THR 5.08/./180FLF

Packaged in box; with solder flange



### Dimensioned drawing

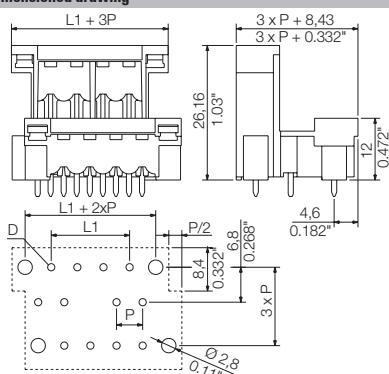

### Ordering data

Solder pin length		3.2 mm		
Colour		Black		
Pitch		5.08 mm		
Pol.	L1	(inch)	Qty.	Order No.
4	5.08	0.200	50	1829010000
6	10.16	0.400	50	1829020000
8	15.24	0.600	50	1829030000
10	20.32	0.800	50	1829040000
12	25.40	1.000	50	1829050000
14	30.48	1.200	20	1829060000
16	35.56	1.400	20	1829070000
18	40.64	1.600	20	1829080000
20	45.72	1.800	20	1829090000
22	50.80	2.000	10	1829100000
24	55.88	2.200	10	1829110000
26	60.96	2.400	10	1829120000
28	66.04	2.600	10	1889200000
30	71.12	2.800	10	1889210000
32	76.20	3.000	10	1866320000
34	81.28	3.200	10	1889220000
36	86.36	3.400	10	1889270000
38	91.44	3.600	10	1889280000
40	96.52	3.800	10	1889290000
42	101.60	4.000	10	1889300000
44	106.68	4.200	10	1889310000
46	111.76	4.400	10	1889320000
48	116.84	4.600	10	1889330000

## Connectors in 5.08 mm pitch Series BL/SL 5.08

### SLH-THR 5.08/./180

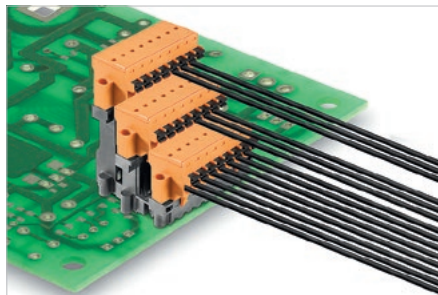

High temperature-resistant male header, optimised for SMT processing. Makes a compact 3-row male header when used together with the SLDV-THR. The connection levels are offset and designed for a female plug with screw connection or "PUSH IN" wire connect. The male headers can be manually coded or ordered as pre-coded headers.

### Product data

IEC: 320 V / 18 A  
UL: 300 V / 10 A



For additional articles and information, refer to [catalog.weidmueller.com](http://catalog.weidmueller.com)

#### Note:

- Rated current related to rated cross-section & min. No. of poles.
- Rated data refer only to the component itself. Clearance and creepage distances to other components are to be designed in accordance with the relevant application standards.

### SLH-THR 5.08/./180F



#### Dimensioned drawing

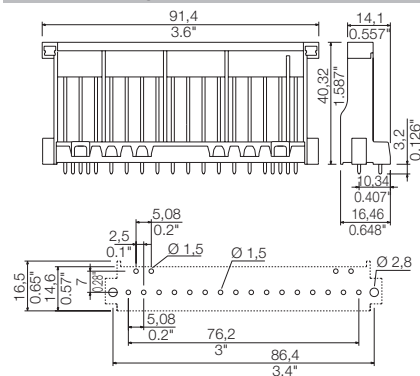

### Ordering data

<b>Solder pin length</b>		3.2 mm	
<b>Colour</b>		Black	
<b>Pitch</b>		5.08 mm	
<b>Pol.</b>	<b>L1</b>	<b>(inch)</b>	<b>Qty. Order No.</b>
16	86.36	3.400	10 1190600000

G

### Technical data

#### In compliance with IEC 60664-1 / IEC 61984

Clamping range, max.			
<b>Solid core H05(07) V-U</b>			
Stranded H07 V-R			
Flexible H05(07) V-K			
Flexible with ferrule			
Ferrule with plastic collar			
Stripping length			
Screwdriver blade	mm		
According to norm			
Tightening torque range			
<b>Rated current, max.</b>	<b>18</b>	<b>13</b>	
At ambient temperature	20°C	40°C	
For conductor cross-section			
Overvoltage category	III	III	II
Pollution severity	3	2	2
<b>Rated voltage</b>	<b>V 200</b>	<b>320</b>	<b>320</b>
Rated impulse voltage	kV 4	4	4
<b>UL / CUL (Use Group)</b>	<b>B</b>	<b>C</b>	<b>D</b>
<b>Rated voltage</b>	<b>V 300</b>	<b>300</b>	
<b>Rated current</b>	<b>A 10</b>	<b>10</b>	
<b>AWG conductor</b>	<b>AWG</b>	-	
<b>CSA (Use Group)</b>	<b>B</b>	<b>C</b>	<b>D</b>
Rated voltage	V 300	300	
Rated current	A 13	10	
AWG conductor	AWG	-	
<b>General data</b>			
Type of insulation material		LCP GF	
UL 94 flammability rating		V-0	
Contact base material		CuSn	
Material of contact surface		tinned	
Pin dimensions = d	mm	1.2, Octagonal	
Solder eyelet Ø = D	mm	1.5	
Solder eyelet Ø tolerance	mm	+ 0,1	

### Accessories

Note: Refer to the Accessories chapter for additional accessories.

Coding	Order No.
BLZ/SL KO OR BX	1573010000
BLZ/SL KO BK BX	1545710000
Partition element	
SL AT OR	1598300000
SL AT SW	1770240000

5.08

180°



## Connectors in 5.08 mm pitch Series BL/SL 5.08

### SL 5.08HC/./90



Male headers made from glass-fibre-reinforced plastic with 90° wire outlet; optimised for wave soldering, absolut dimension stable. The male headers can be manually coded or ordered as pre-coded headers.

- Available in open, closed (G), with screw flange (F) or with solder Flange (LF).
- The solder flange makes an additional screw-fixation to the PCB unnecessary and protects the solder joints against mechanical stress.

### Product data

IEC: 400 V / 24 A  
UL: 300 V / 18.5 A



For additional articles and information, refer to [catalog.weidmuller.com](http://catalog.weidmuller.com)

#### Note:

- Additional colours on request
- Gold-plated contact surfaces on request
- Rated current related to rated cross-section & min. No. of poles.
- P on drawing = pitch
- Rated data refer only to the component itself. Clearance and creepage distances to other components are to be designed in accordance with the relevant application standards.

### SL 5.08HC/./90



#### Dimensioned drawing

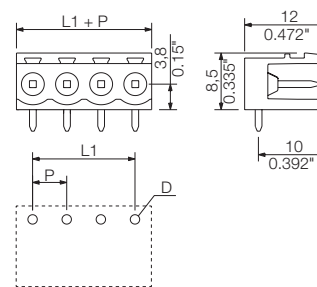

## G

### Technical data

In compliance with IEC 60664-1 / IEC 61984			
Clamping range, max.			
<b>Solid core H05(07) V-U</b>			
Stranded H07 V-R			
Flexible H05(07) V-K			
Flexible with ferrule			
Ferrule with plastic collar			
Stripping length			
Screwdriver blade	mm		
According to norm			
Tightening torque range			
<b>Rated current, max.</b>	<b>A</b>	<b>24</b>	<b>21</b>
At ambient temperature		20°C	40°C
For conductor cross-section			
Overvoltage category		III	III II
Pollution severity		3	2 2
<b>Rated voltage</b>	<b>V</b>	<b>250</b>	<b>320 400</b>
Rated impulse voltage	kV	4	4 4
<b>UL / CUL (Use Group)</b>	<b>B C D</b>		
<b>Rated voltage</b>	<b>V</b>	<b>300</b>	<b>300</b>
<b>Rated current</b>	<b>A</b>	<b>18.5</b>	<b>10</b>
<b>AWG conductor</b>	<b>AWG</b>		
<b>CSA (Use Group)</b>	<b>B C D</b>		
Rated voltage	V	300	300
Rated current	A	18.5	10
AWG conductor	AWG		
<b>General data</b>			
Type of insulation material		PA GF	
UL 94 flammability rating		V-0	
Contact base material		CuMg	
Material of contact surface		tinned	
Pin dimensions = d	mm	1.2, Octagonal	
Solder eyelet Ø = D	mm	1.3	
Solder eyelet Ø tolerance	mm	+ 0,1	

### Accessories

Note: Refer to the Accessories chapter for additional accessories.		
Coding		Order No.
	BLZ/SL KO OR BX	1573010000
	BLZ/SL KO BK BX	1545710000
<b>Partition element</b>		
	SL AT OR	1598300000
	SL AT SW	1770240000
<b>LED light guide</b>		
	SL FLA 1.5/1	1580100000
	SL FLA 2,3/1	1636670000
	SL FLA 2,3/24	1636680000
	SL FLA 3.8/1	1580110000
	SL FLA 9.0/1	1580120000
<b>Mounting block</b>		
	SLA BB11R OR	1604120000
	SLA BB11R SW	1692340000

### Ordering data

Solder pin length		3.2 mm		
Colour		Orange		
Pitch	5.08 mm			
Pol.	L1	(inch)	Qty.	Order No.
2	5.08	0.200	100	1146720000
3	10.16	0.400	100	1146740000
4	15.24	0.600	100	1146770000
5	20.32	0.800	50	1146790000
6	25.40	1.000	50	1146810000
7	30.48	1.200	50	1146830000
8	35.56	1.400	50	1146850000
9	40.64	1.600	50	1146880000
10	45.72	1.800	50	1146900000
11	50.80	2.000	50	1146920000
12	55.88	2.200	50	1146940000
13	60.96	2.400	50	1146970000
14	66.04	2.600	50	1146990000
15	71.12	2.800	50	1147010000
16	76.20	3.000	50	1147030000
17	81.28	3.200	20	1147050000
18	86.36	3.400	20	1147080000
19	91.44	3.600	20	1147100000
20	96.52	3.800	20	1147120000
21	101.60	4.000	20	1147150000
22	106.68	4.200	20	1147190000
23	111.76	4.400	20	1147220000
24	116.84	4.600	20	1147250000

### SL 5.08HC../90G



Dimensioned drawing

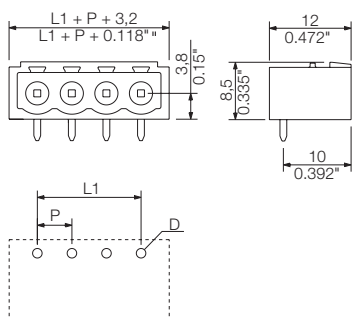

### SL 5.08HC../90B



Dimensioned drawing

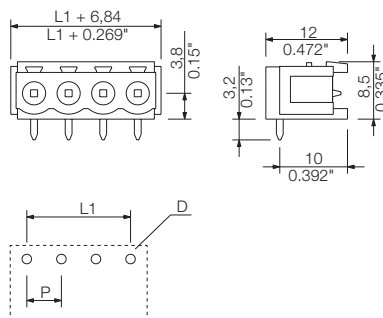

#### Ordering data

Solder pin length		3.2 mm			
Colour		Orange			
Pitch		5.08 mm			
Pol.	L1	(inch)	Qty.	Order No.	
2	5.08	0.200	100	1147280000	
3	10.16	0.400	100	1147310000	
4	15.24	0.600	100	1147340000	
5	20.32	0.800	50	1147370000	
6	25.40	1.000	50	1147400000	
7	30.48	1.200	50	1147420000	
8	35.56	1.400	50	1147450000	
9	40.64	1.600	50	1147490000	
10	45.72	1.800	50	1147530000	
11	50.80	2.000	50	1147570000	
12	55.88	2.200	50	1147600000	
13	60.96	2.400	50	1147630000	
14	66.04	2.600	50	1147680000	
15	71.12	2.800	50	1147700000	
16	76.20	3.000	50	1147740000	
17	81.28	3.200	20	1147780000	
18	86.36	3.400	20	1147810000	
19	91.44	3.600	20	1147840000	
20	96.52	3.800	20	1147880000	
21	101.60	4.000	20	1147910000	
22	106.68	4.200	20	1147940000	
23	111.76	4.400	20	1147980000	
24	116.84	4.600	20	1148000000	

#### Ordering data

Solder pin length		3.2 mm			
Colour		Orange			
Pitch		5.08 mm			
Pol.	L1	(inch)	Qty.	Order No.	
2	5.08	0.200	100	1148030000	
3	10.16	0.400	100	1148070000	
4	15.24	0.600	100	1148100000	
5	20.32	0.800	50	1148130000	
6	25.40	1.000	50	1148170000	
7	30.48	1.200	50	1148200000	
8	35.56	1.400	50	1154830000	
9	40.64	1.600	50	1154840000	
10	45.72	1.800	50	1154850000	
11	50.80	2.000	50	1154870000	
12	55.88	2.200	50	1154880000	
13	60.96	2.400	50	1154890000	
14	66.04	2.600	50	1154900000	
15	71.12	2.800	50	1154910000	
16	76.20	3.000	50	1154920000	
17	81.28	3.200	20	1154930000	
18	86.36	3.400	20	1154940000	
19	91.44	3.600	20	1154950000	
20	96.52	3.800	20	1154970000	
21	101.60	4.000	20	1154980000	
22	106.68	4.200	20	1154990000	
23	111.76	4.400	20	1155010000	
24	116.84	4.600	20	1155020000	

## Connectors in 5.08 mm pitch Series BL/SL 5.08

### SL 5.08HC/./90



Male headers made from glass-fibre-reinforced plastic with 90° wire outlet; optimised for wave soldering, absolut dimension stable. The male headers can be manually coded or ordered as pre-coded headers.

- Available in open, closed (G), with screw flange (F) or with solder flange (LF).
- The solder flange makes an additional screw-fixation to the PCB unnecessary and protects the solder joints against mechanical stress.

### Product data

IEC: 400 V / 24 A  
UL: 300 V / 18.5 A



For additional articles and information, refer to [catalog.weidmuller.com](http://catalog.weidmuller.com)

#### Note:

- Additional colours on request
- Gold-plated contact surfaces on request
- Rated current related to rated cross-section & min. No. of poles.
- P on drawing = pitch
- Rated data refer only to the component itself. Clearance and creepage distances to other components are to be designed in accordance with the relevant application standards.

### SL 5.08HC/./90F



#### Dimensioned drawing

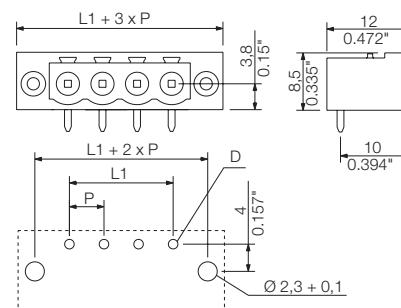

## G

### Technical data

#### In compliance with IEC 60664-1 / IEC 61984

Clamping range, max.			
<b>Solid core H05(07) V-U</b>			
Stranded H07 V-R			
Flexible H05(07) V-K			
Flexible with ferrule			
Ferrule with plastic collar			
Stripping length			
Screwdriver blade	mm		
According to norm			
Tightening torque range			
<b>Rated current, max.</b>	<b>A</b>	<b>24</b>	<b>21</b>
At ambient temperature		20°C	40°C
For conductor cross-section		III	III
Overvoltage category		III	II
Pollution severity		3	2
<b>Rated voltage</b>	<b>V</b>	<b>250</b>	<b>320</b>
Rated impulse voltage	kV	4	4
<b>UL / CUL (Use Group)</b>	<b>B</b>	<b>C</b>	<b>D</b>
<b>Rated voltage</b>	<b>V</b>	<b>300</b>	<b>300</b>
<b>Rated current</b>	<b>A</b>	<b>18.5</b>	<b>10</b>
<b>AWG conductor</b>	<b>AWG</b>	-	-
<b>CSA (Use Group)</b>	<b>B</b>	<b>C</b>	<b>D</b>
Rated voltage	V	300	300
Rated current	A	18.5	10
AWG conductor	AWG	-	-
<b>General data</b>			
Type of insulation material		PA GF	
UL 94 flammability rating		V-0	
Contact base material		CuMg	
Material of contact surface		tinned	
Pin dimensions = d	mm	1.2, Octagonal	
Solder eyelet Ø = D	mm	1.3	
Solder eyelet Ø tolerance	mm	+ 0,1	

### Accessories

Note: Refer to the Accessories chapter for additional accessories.

Coding	Order No.
BLZ/SL KO OR BX	<b>1573010000</b>
BLZ/SL KO BK BX	<b>1545710000</b>
<b>Partition element</b>	
SL AT OR	<b>1598300000</b>
SL AT SW	<b>1770240000</b>
<b>LED light guide</b>	
SL FLA 1.5/1	<b>1580100000</b>
SL FLA 2,3/1	<b>1636670000</b>
SL FLA 2,3/24	<b>1636680000</b>
SL FLA 3,8/1	<b>1580110000</b>
SL FLA 9,0/1	<b>1580120000</b>

### Ordering data

Solder pin length		3.2 mm		
Colour		Orange		
Pitch	5.08 mm			
Pol.	L1	(inch)	Qty.	Order No.
2	5.08	0.200	90	<b>1148610000</b>
3	10.16	0.400	72	<b>1148640000</b>
4	15.24	0.600	60	<b>1148680000</b>
5	20.32	0.800	48	<b>1148710000</b>
6	25.40	1.000	42	<b>1148740000</b>
7	30.48	1.200	36	<b>1148780000</b>
8	35.56	1.400	36	<b>1148810000</b>
9	40.64	1.600	30	<b>1148840000</b>
10	45.72	1.800	30	<b>1148880000</b>
11	50.80	2.000	24	<b>1148910000</b>
12	55.88	2.200	24	<b>1148940000</b>
13	60.96	2.400	24	<b>1148980000</b>
14	66.04	2.600	18	<b>1149010000</b>
15	71.12	2.800	18	<b>1149040000</b>
16	76.20	3.000	18	<b>1149080000</b>
17	81.28	3.200	18	<b>1149110000</b>
18	86.36	3.400	18	<b>1149140000</b>
19	91.44	3.600	12	<b>1149180000</b>
20	96.52	3.800	12	<b>1149210000</b>
21	101.60	4.000	12	<b>1149240000</b>
22	106.68	4.200	12	<b>1149280000</b>
23	111.76	4.400	12	<b>1149310000</b>
24	116.84	4.600	12	<b>1149340000</b>

5.08

90°



## SL 5.08HC/./90LF

with solder flange



Dimensioned drawing

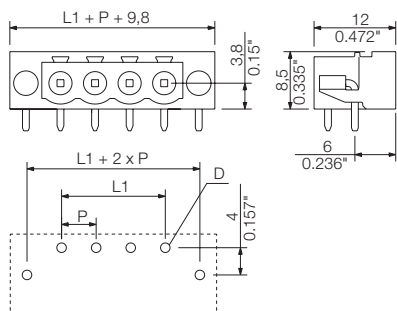

## Solder flange (LF)

Normally you use a pin header with fastening flanges (F) in combination with a screw from the rear side of the PCB to increase the fixation forces of the pin headers. The disadvantages are additional process steps that make the PCB mounting complex and cost intensive. The patented solder flange was designed to solve exactly this problem and find a simple and cheap solution. The additional solder pins substitute the present screw flanges and they get soldered together with the pin header. This terminates additional process steps and thus reduces production costs. The additional fixation protects the soldered connections from tensile strain and avoids permanent mechanical stress such as caused by the post-fastened screw forces.

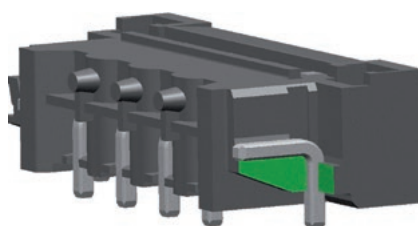

## Ordering data

Solder pin length		3.2 mm		
Colour		Orange		
Pitch		5.08 mm		
Pol.	L1	(inch)	Qty.	Order No.
2	5.08	0.200	90	1149380000
3	10.16	0.400	72	1149410000
4	15.24	0.600	60	1149440000
5	20.32	0.800	48	1149480000
6	25.40	1.000	42	1149510000
7	30.48	1.200	36	1149540000
8	35.56	1.400	36	1149580000
9	40.64	1.600	30	1149610000
10	45.72	1.800	30	1149640000
11	50.80	2.000	24	1149680000
12	55.88	2.200	24	1149710000
13	60.96	2.400	24	1149740000
14	66.04	2.600	18	1149780000
15	71.12	2.800	18	1149810000
16	76.20	3.000	18	1149840000
17	81.28	3.200	18	1149880000
18	86.36	3.400	18	1149910000
19	91.44	3.600	12	1149940000
20	96.52	3.800	12	1149980000
21	101.60	4.000	12	1150000000
22	106.68	4.200	12	1150020000
23	111.76	4.400	12	1150040000
24	116.84	4.600	12	1150070000

## Connectors in 5.08 mm pitch Series BL/SL 5.08

### SL 5.08HC/./180

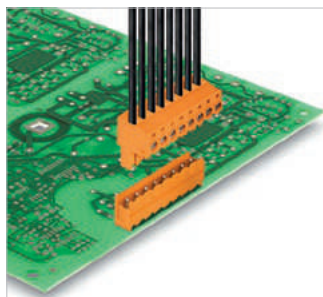

Male headers made from glass-fibre-reinforced plastic with 180° wire outlet; optimised for wave soldering, absolut dimension stable. The male headers can be manually coded or ordered as pre-coded headers.

- Available in open, closed (G), with screw flange (F) or with solder Flange (LF).
- The solder flange makes an additional screw-fixation to the PCB unnecessary and protects the solder joints against mechanical stress.

### Product data

IEC: 400 V / 24 A  
UL: 300 V / 18.5 A



For additional articles and information, refer to [catalog.weidmuller.com](http://catalog.weidmuller.com)

#### Note:

- Additional colours on request
- Gold-plated contact surfaces on request
- Rated current related to rated cross-section & min. No. of poles.
- P on drawing = pitch
- Rated data refer only to the component itself. Clearance and creepage distances to other components are to be designed in accordance with the relevant application standards.

### SL 5.08HC/./180



#### Dimensioned drawing

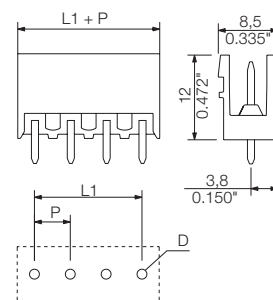

### Technical data

#### In compliance with IEC 60664-1 / IEC 61984

Clamping range, max.			
<b>Solid core H05(07) V-U</b>			
Stranded H07 V-R			
Flexible H05(07) V-K			
Flexible with ferrule			
Ferrule with plastic collar			
Stripping length			
Screwdriver blade	mm		
According to norm			
Tightening torque range			
<b>Rated current, max.</b>	<b>A</b>	<b>24</b>	<b>21</b>
At ambient temperature		20°C	40°C
For conductor cross-section			
Overvoltage category		III	III II
Pollution severity		3	2 2
<b>Rated voltage</b>	<b>V</b>	<b>250</b>	<b>320 400</b>
Rated impulse voltage	kV	4	4 4
<b>UL / CUL (Use Group)</b>	<b>B C D</b>		

<b>Rated voltage</b>	<b>V</b>	<b>300</b>	<b>300</b>
<b>Rated current</b>	<b>A</b>	<b>18.5</b>	<b>10</b>
<b>AWG conductor</b>	<b>AWG</b>	-	
<b>CSA (Use Group)</b>	<b>B C D</b>		
Rated voltage	V	300	300
Rated current	A	18.5	18.5
AWG conductor	AWG	-	

<b>General data</b>			
Type of insulation material		PA GF	
UL 94 flammability rating		V-0	
Contact base material		CuMg	
Material of contact surface		tinned	
Pin dimensions = d	mm	1.2, Octagonal	
Solder eyelet Ø = D	mm	1.3	
Solder eyelet Ø tolerance	mm	+ 0,1	

### Accessories

Note: Refer to the Accessories chapter for additional accessories.

Coding	Order No.
BLZ/SL KO OR BX	<b>1573010000</b>
BLZ/SL KO BK BX	<b>1545710000</b>
<b>Partition element</b>	
SL AT OR	<b>1598300000</b>
SL AT SW	<b>1770240000</b>
<b>Mounting block</b>	
SLA BB11R OR	<b>1604120000</b>
SLA BB11R SW	<b>1692340000</b>

### Ordering data

Solder pin length		3.2 mm		
Colour		Orange		
Pitch	5.08 mm			
Pol.	L1	(inch)	Qty.	Order No.
2	5.08	0.200	100	<b>1146320000</b>
3	10.16	0.400	100	<b>1146340000</b>
4	15.24	0.600	100	<b>1146380000</b>
5	20.32	0.800	50	<b>1146410000</b>
6	25.40	1.000	50	<b>1146450000</b>
7	30.48	1.200	50	<b>1146470000</b>
8	35.56	1.400	50	<b>1146490000</b>
9	40.64	1.600	50	<b>1146510000</b>
10	45.72	1.800	50	<b>1146530000</b>
11	50.80	2.000	50	<b>1146550000</b>
12	55.88	2.200	50	<b>1146570000</b>
13	60.96	2.400	50	<b>1146580000</b>
14	66.04	2.600	50	<b>1146590000</b>
15	71.12	2.800	50	<b>1146600000</b>
16	76.20	3.000	50	<b>1146610000</b>
17	81.28	3.200	20	<b>1146620000</b>
18	86.36	3.400	20	<b>1146630000</b>
19	91.44	3.600	20	<b>1146640000</b>
20	96.52	3.800	20	<b>1146650000</b>
21	101.60	4.000	20	<b>1146680000</b>
22	106.68	4.200	20	<b>1146690000</b>
23	111.76	4.400	20	<b>1146700000</b>
24	116.84	4.600	20	<b>1146710000</b>

### SL 5.08HC../180G



Dimensioned drawing

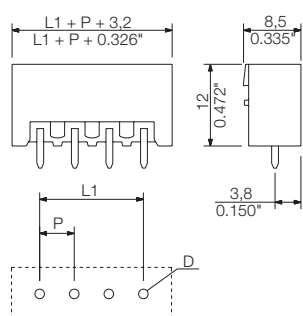

#### Ordering data

Solder pin length		3.2 mm	
Colour		Orange	
Pitch		5.08 mm	
Pol.	L1	(inch)	Qty. Order No.
2	5.08	0.200	100 1146730000
3	10.16	0.400	100 1146750000
4	15.24	0.600	100 1146780000
5	20.32	0.800	50 1146800000
6	25.40	1.000	50 1146820000
7	30.48	1.200	50 1146840000
8	35.56	1.400	50 1146870000
9	40.64	1.600	50 1146890000
10	45.72	1.800	50 1146910000
11	50.80	2.000	50 1146930000
12	55.88	2.200	50 1146950000
13	60.96	2.400	50 1146980000
14	66.04	2.600	50 1147000000
15	71.12	2.800	50 1147020000
16	76.20	3.000	50 1147040000
17	81.28	3.200	20 1147070000
18	86.36	3.400	20 1147090000
19	91.44	3.600	20 1147110000
20	96.52	3.800	20 1147140000
21	101.60	4.000	20 1147180000
22	106.68	4.200	20 1147210000
23	111.76	4.400	20 1147240000
24	116.84	4.600	20 1147270000

### SL 5.08HC../180B



Dimensioned drawing

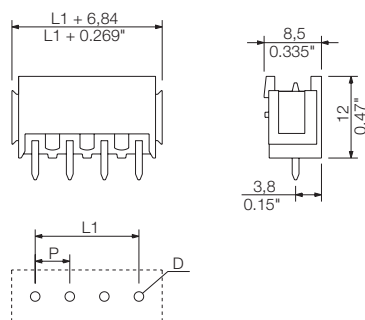

#### Ordering data

Solder pin length		3.2 mm	
Colour		Orange	
Pitch		5.08 mm	
Pol.	L1	(inch)	Qty. Order No.
2	5.08	0.200	100 1147300000
3	10.16	0.400	100 1147330000
4	15.24	0.600	100 1147360000
5	20.32	0.800	50 1147390000
6	25.40	1.000	50 1147430000
7	30.48	1.200	50 1147470000
8	35.56	1.400	50 1147510000
9	40.64	1.600	50 1147540000
10	45.72	1.800	50 1147580000
11	50.80	2.000	50 1147610000
12	55.88	2.200	50 1147640000
13	60.96	2.400	50 1147670000
14	66.04	2.600	50 1147710000
15	71.12	2.800	50 1147730000
16	76.20	3.000	50 1147770000
17	81.28	3.200	20 1147800000
18	86.36	3.400	20 1147830000
19	91.44	3.600	20 1147870000
20	96.52	3.800	20 1147900000
21	101.60	4.000	20 1147930000
22	106.68	4.200	20 1147970000
23	111.76	4.400	20 1148010000
24	116.84	4.600	20 1148040000

## Connectors in 5.08 mm pitch Series BL/SL 5.08

### SL 5.08HC/./180

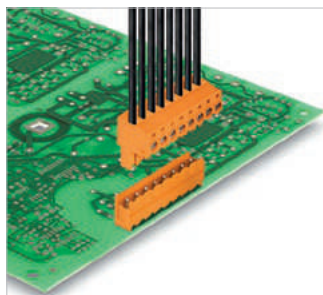

Male headers made from glass-fibre-reinforced plastic with 180° wire outlet; optimised for wave soldering, absolut dimension stable. The male headers can be manually coded or ordered as pre-coded headers.

- Available in open, closed (G), with screw flange (F) or with solder flange (LF).
- The solder flange makes an additional screw-fixation to the PCB unnecessary and protects the solder joints against mechanical stress.

### Product data

IEC: 400 V / 24 A  
UL: 300 V / 18.5 A



For additional articles and information, refer to [catalog.weidmuller.com](http://catalog.weidmuller.com)

#### Note:

- Additional colours on request
- Gold-plated contact surfaces on request
- Rated current related to rated cross-section & min. No. of poles.
- P on drawing = pitch
- Rated data refer only to the component itself. Clearance and creepage distances to other components are to be designed in accordance with the relevant application standards.

### SL 5.08HC/./180F



#### Dimensioned drawing

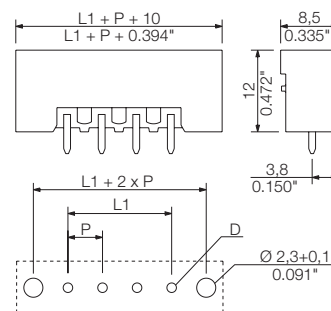

## G

### Technical data

#### In compliance with IEC 60664-1 / IEC 61984

Clamping range, max.			
<b>Solid core H05(07) V-U</b>			
Stranded H07 V-R			
Flexible H05(07) V-K			
Flexible with ferrule			
Ferrule with plastic collar			
Stripping length			
Screwdriver blade	mm		
According to norm			
Tightening torque range			
<b>Rated current, max.</b>	<b>A</b>	<b>24</b>	<b>21</b>
At ambient temperature		20°C	40°C
For conductor cross-section		III	III II
Overtoltage category		3	2 2
Pollution severity		3	2 2
<b>Rated voltage</b>	<b>V</b>	<b>250</b>	<b>320 400</b>
Rated impulse voltage	kV	4	4 4
<b>UL / CUL (Use Group)</b>	<b>B C D</b>		
<b>Rated voltage</b>	<b>V</b>	<b>300</b>	<b>300</b>
<b>Rated current</b>	<b>A</b>	<b>18.5</b>	<b>10</b>
<b>AWG conductor</b>	<b>AWG</b>	-	
<b>CSA (Use Group)</b>	<b>B C D</b>		
Rated voltage	V	300	300
Rated current	A	18.5	18.5
AWG conductor	AWG	-	
<b>General data</b>			
Type of insulation material		PA GF	
UL 94 flammability rating		V-0	
Contact base material		CuMg	
Material of contact surface		tinned	
Pin dimensions = d	mm	1.2, Octagonal	
Solder eyelet Ø = D	mm	1.3	
Solder eyelet Ø tolerance	mm	+ 0,1	

### Accessories

Note: Refer to the Accessories chapter for additional accessories.

Coding	Order No.
BLZ/SL KO OR BX	<b>1573010000</b>
BLZ/SL KO BK BX	<b>1545710000</b>
Partition element	
SL AT OR	<b>1598300000</b>
SL AT SW	<b>1770240000</b>

### Ordering data

Solder pin length		3.2 mm		
Colour		Orange		
Pitch		5.08 mm		
Pol.	L1	(inch)	Qty.	Order No.
2	5.08	0.200	90	<b>1147130000</b>
3	10.16	0.400	72	<b>1147170000</b>
4	15.24	0.600	60	<b>1147200000</b>
5	20.32	0.800	48	<b>1147230000</b>
6	25.40	1.000	42	<b>1147260000</b>
7	30.48	1.200	36	<b>1147290000</b>
8	35.56	1.400	36	<b>1147320000</b>
9	40.64	1.600	30	<b>1147350000</b>
10	45.72	1.800	30	<b>1147380000</b>
11	50.80	2.000	24	<b>1147410000</b>
12	55.88	2.200	24	<b>1147440000</b>
13	60.96	2.400	24	<b>1147480000</b>
14	66.04	2.600	18	<b>1147520000</b>
15	71.12	2.800	18	<b>1147550000</b>
16	76.20	3.000	18	<b>1147590000</b>
17	81.28	3.200	18	<b>1147620000</b>
18	86.36	3.400	18	<b>1147650000</b>
19	91.44	3.600	12	<b>1147690000</b>
20	96.52	3.800	12	<b>1147720000</b>
21	101.60	4.000	12	<b>1147750000</b>
22	106.68	4.200	12	<b>1147790000</b>
23	111.76	4.400	12	<b>1147820000</b>
24	116.84	4.600	12	<b>1147850000</b>

## SL 5.08HC../180LF

with solder flange



Dimensioned drawing

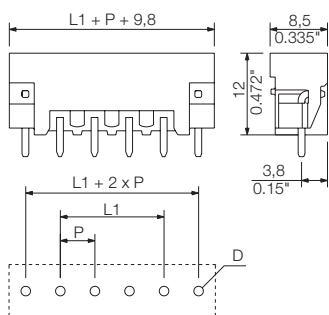

### Ordering data

Solder pin length		3.2 mm		
Colour		Orange		
Pitch		5.08 mm		
Pol.	L1	(inch)	Qty.	Order No.
2	5.08	0.200	90	1147890000
3	10.16	0.400	72	1147920000
4	15.24	0.600	60	1147950000
5	20.32	0.800	48	1147990000
6	25.40	1.000	42	1148020000
7	30.48	1.200	36	1148050000
8	35.56	1.400	36	1148090000
9	40.64	1.600	30	1148120000
10	45.72	1.800	30	1148150000
11	50.80	2.000	24	1148190000
12	55.88	2.200	24	1148220000
13	60.96	2.400	24	1148240000
14	66.04	2.600	18	1148260000
15	71.12	2.800	18	1148280000
16	76.20	3.000	18	1148300000
17	81.28	3.200	18	1148320000
18	86.36	3.400	18	1148340000
19	91.44	3.600	12	1148360000
20	96.52	3.800	12	1148380000
21	101.60	4.000	12	1148400000
22	106.68	4.200	12	1148420000
23	111.76	4.400	12	1148440000
24	116.84	4.600	12	1148470000



## Connectors in 5.08 mm pitch Series BL/SL 5.08

### SLD 5.08V/./90 & 180

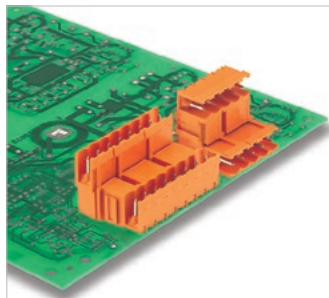

Double-level male header optimised for wave soldering. The connection levels are offset and designed for a female plug with screw- or "PUSH IN" wire connect. All male headers can be manually coded or ordered as pre-coded headers.

### Product data

IEC: 400 V / 17 A  
UL: 300 V / 10 A



For additional articles and information, refer to [catalog.weidmuller.com](http://catalog.weidmuller.com)

#### Note:

- Additional colours on request
- Rated current related to rated cross-section & min. No. of poles.
- Spacing between rows: see hole layout
- P on drawing = pitch
- Rated data refer only to the component itself. Clearance and creepage distances to other components are to be designed in accordance with the relevant application standards.

### SLD 5.08V/90



#### Dimensioned drawing

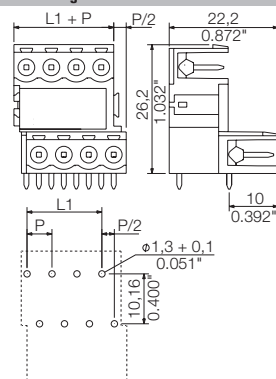

### Ordering data

Solder pin length		3.2 mm		
Colour		Orange		
Pitch		5.08 mm		
Pol.	L1	(inch)	Qty.	Order No.
4	5.08	0.200	50	1725170000
6	10.16	0.400	50	1725180000
8	15.24	0.600	50	1725190000
10	20.32	0.800	50	1725200000
12	25.40	1.000	50	1725210000
14	30.48	1.200	20	1725220000
16	35.56	1.400	20	1725230000
18	40.64	1.600	20	1725240000
20	45.72	1.800	20	1725250000
22	50.80	2.000	10	1725260000
24	55.88	2.200	10	1725270000
26	60.96	2.400	10	1725280000
28	66.04	2.600	10	1725290000
30	71.12	2.800	10	1725300000
32	76.20	3.000	10	1725310000
34	81.28	3.200	10	1725320000
36	86.36	3.400	10	1725330000
38	91.44	3.600	10	1725340000
40	96.52	3.800	10	1725350000
42	101.60	4.000	10	1725360000
44	106.68	4.200	10	1725370000
46	111.76	4.400	10	1725380000
48	116.84	4.600	10	1725390000

### Technical data

#### In compliance with IEC 60664-1 / IEC 61984

Clamping range, max.				
<b>Solid core H05(07) V-U</b>				
Stranded H07 V-R				
Flexible H05(07) V-K				
Flexible with ferrule				
Ferrule with plastic collar				
Stripping length				
Screwdriver blade	mm			
According to norm				
Tightening torque range				
<b>Rated current, max.</b>	<b>17</b>	<b>15</b>		
At ambient temperature	20°C	40°C		
For conductor cross-section				
Overvoltage category	III	III	II	
Pollution severity	3	2	2	
<b>Rated voltage</b>	<b>V</b>	<b>250</b>	<b>320</b>	<b>400</b>
Rated impulse voltage	kV	4	4	4
<b>UL / CUL (Use Group)</b>	<b>B</b>	<b>C</b>	<b>D</b>	
<b>Rated voltage</b>	<b>V</b>	<b>300</b>	<b>300</b>	
<b>Rated current</b>	<b>A</b>	<b>10</b>	<b>10</b>	
<b>AWG conductor</b>	<b>AWG</b>	-		
<b>CSA (Use Group)</b>	<b>B</b>	<b>C</b>	<b>D</b>	
Rated voltage	V	300	300	
Rated current	A	10	10	
AWG conductor	AWG	-		
<b>General data</b>				
Type of insulation material				PBT
UL 94 flammability rating				V-0
Contact base material				CuSn
Material of contact surface				tinned
Pin dimensions = d	mm	1.2, Octagonal		
Solder eyelet Ø = D	mm	1.3		
Solder eyelet Ø tolerance	mm	+ 0,1		

### Accessories

Note: Refer to the Accessories chapter for additional accessories.

Mounting block		Order No.
	SLA BB14 OR	1594200000
	SLA BB14 SW	1774460000
<b>Coding</b>		
	BLZ/SL KO OR BX	1573010000
	BLZ/SL KO BK BX	1545710000
<b>Partition element</b>		
	SL AT OR	1598300000
	SL AT SW	1770240000

SLD 5.08V/180



Dimensioned drawing

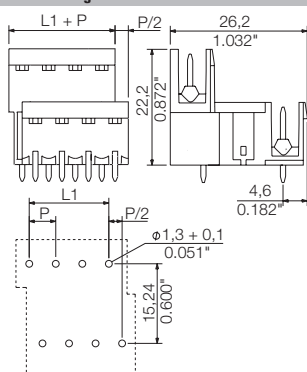

Ordering data

Solder pin length		3.2 mm		
Colour		Orange		
Pitch		5.08 mm		
Pol.	L1	(inch)	Qty.	Order No.
4	5.08	0.200	50	1725650000
6	10.16	0.400	50	1725660000
8	15.24	0.600	50	1725670000
10	20.32	0.800	50	1725680000
12	25.40	1.000	50	1725690000
14	30.48	1.200	20	1725700000
16	35.56	1.400	20	1725710000
18	40.64	1.600	20	1725720000
20	45.72	1.800	20	1725730000
22	50.80	2.000	10	1725740000
24	55.88	2.200	10	1725750000
26	60.96	2.400	10	1725760000
28	66.04	2.600	10	1725770000
30	71.12	2.800	10	1725780000
32	76.20	3.000	10	1725790000
34	81.28	3.200	10	1725800000
36	86.36	3.400	10	1725810000
38	91.44	3.600	10	1725820000
40	96.52	3.800	10	1725830000
42	101.60	4.000	10	1725840000
44	106.68	4.200	10	1725850000
46	111.76	4.400	10	1725860000
48	116.84	4.600	10	1725870000



## Connectors in 5.08 mm pitch Series BL/SL 5.08

### SLD 5.08/./90 & 180

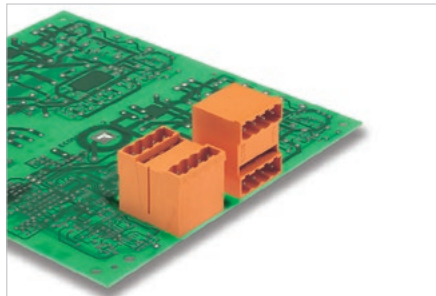

Double-level male header optimised for wave soldering. The connections are at the same level – with access that is flush over the front board. The male headers can be manually coded or ordered as pre-coded headers.

### Product data

IEC: 400 V / 11 A  
UL: 300 V / 10 A



For additional articles and information, refer to [catalog.weidmuller.com](http://catalog.weidmuller.com)

#### Note:

- Additional colours on request
- Rated current related to rated cross-section & min. No. of poles.
- Spacing between rows: see hole layout
- P on drawing = pitch
- Rated data refer only to the component itself. Clearance and creepage distances to other components are to be designed in accordance with the relevant application standards.

### SLD 5.08/./90G



#### Dimensioned drawing

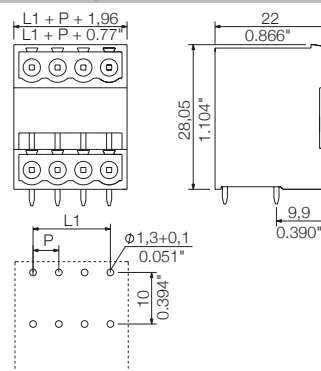

### Technical data

#### In compliance with IEC 60664-1 / IEC 61984

Clamping range, max.			
<b>Solid core H05(07) V-U</b>			
Stranded H07 V-R			
Flexible H05(07) V-K			
Flexible with ferrule			
Ferrule with plastic collar			
Stripping length			
Screwdriver blade	mm		
According to norm			
Tightening torque range			
<b>Rated current, max.</b>	<b>A</b>	<b>11</b>	<b>9.5</b>
At ambient temperature		20°C	40°C
For conductor cross-section			
Overtoltage category		III	III II
Pollution severity		3	2 2
<b>Rated voltage</b>	<b>V</b>	<b>250</b>	<b>320 400</b>
Rated impulse voltage	kV	4	4 4
<b>UL / CUL (Use Group)</b>	<b>B C D</b>		
<b>Rated voltage</b>	<b>V</b>	<b>300</b>	<b>300</b>
<b>Rated current</b>	<b>A</b>	<b>10</b>	<b>10</b>
<b>AWG conductor</b>	<b>AWG</b>	-	
<b>CSA (Use Group)</b>	<b>B C D</b>		
Rated voltage	V	300	300
Rated current	A	10	10
AWG conductor	AWG	-	
<b>General data</b>			
Type of insulation material	PBT		
UL 94 flammability rating	V-0		
Contact base material	CuSn		
Material of contact surface	tinned		
Pin dimensions = d	mm	1.2, Octagonal	
Solder eyelet Ø = D	mm	1.3	
Solder eyelet Ø tolerance	mm	+ 0,1	

### Accessories

Note: Refer to the Accessories chapter for additional accessories.

Coding	Order No.
BLZ/SL KO OR BX	<b>1573010000</b>
BLZ/SL KO BK BX	<b>1545710000</b>
Partition element	
SL AT OR	<b>1598300000</b>
SL AT SW	<b>1770240000</b>

### Ordering data

Solder pin length		3.2 mm		
Colour		Orange		
Pitch		5.08 mm		
Pol.	L1	(inch)	Qty.	Order No.
4	5.08	0.200	50	<b>1601790000</b>
6	10.16	0.400	50	<b>1601800000</b>
8	15.24	0.600	50	<b>1601810000</b>
10	20.32	0.800	50	<b>1601820000</b>
12	25.40	1.000	50	<b>1601830000</b>
14	30.48	1.200	20	<b>1601840000</b>
16	35.56	1.400	20	<b>1601850000</b>
18	40.64	1.600	20	<b>1601860000</b>
20	45.72	1.800	20	<b>1601870000</b>
22	50.80	2.000	10	<b>1601880000</b>
24	55.88	2.200	10	<b>1601890000</b>
26	60.96	2.400	10	<b>1601900000</b>
28	66.04	2.600	10	<b>1601910000</b>
30	71.12	2.800	10	<b>1601920000</b>
32	76.20	3.000	10	<b>1601930000</b>
34	81.28	3.200	10	<b>1601940000</b>
36	86.36	3.400	10	<b>1601950000</b>
38	91.44	3.600	10	<b>1601960000</b>
40	96.52	3.800	10	<b>1601970000</b>
42	101.60	4.000	10	<b>1601980000</b>
44	106.68	4.200	10	<b>1601990000</b>
46	111.76	4.400	10	<b>1602000000</b>
48	116.84	4.600	10	<b>1602010000</b>

G

5.08

90°



SLD 5.08/./180G



Dimensioned drawing

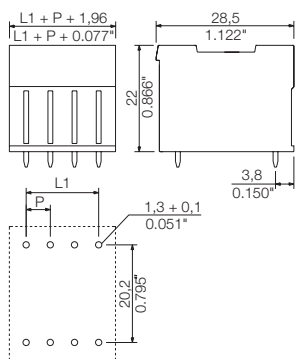

Ordering data

Solder pin length		3.2 mm		
Colour		Orange		
Pitch		5.08 mm		
Pol.	L1	(inch)	Qty.	Order No.
4	5.08	0.200	50	1602390000
6	10.16	0.400	50	1602400000
8	15.24	0.600	50	1602410000
10	20.32	0.800	50	1602420000
12	25.40	1.000	50	1602430000
14	30.48	1.200	20	1602440000
16	35.56	1.400	20	1602450000
18	40.64	1.600	20	1602460000
20	45.72	1.800	20	1602470000
22	50.80	2.000	10	1602480000
24	55.88	2.200	10	1602490000
26	60.96	2.400	10	1602500000
28	66.04	2.600	10	1602510000
30	71.12	2.800	10	1602520000
32	76.20	3.000	10	1602530000
34	81.28	3.200	10	1602540000
36	86.36	3.400	10	1602550000
38	91.44	3.600	10	1602560000
40	96.52	3.800	10	1602570000
42	101.60	4.000	10	1602580000
44	106.68	4.200	10	1602590000
46	111.76	4.400	10	1602600000
48	116.84	4.600	10	1602610000



## Connectors in 5.08 mm pitch Series BL/SL 5.08

### SLDF 5.08 L/F..



Feed-through male connector with optional locking function, for mounting on front plate. Internal connection as flat-blade or solder connection. All male headers can be manually coded or ordered as pre-coded headers.

### Product data

IEC: 400 V / 15 A  
UL: 300 V / 10 A



For additional articles and information, refer to [catalog.weidmueller.com](http://catalog.weidmueller.com)

#### Note:

- Additional colours on request
- Rated current related to rated cross-section & min. No. of poles.
- Connectable cables with solder connection solid and flexible up to 2.5 mm<sup>2</sup> with insulating/shrink-wrap sleeve or from 2.8 mm flat blade receptacles with insulated sleeves acc. to DIN IEC 760
- P on drawing = pitch
- Rated data refer only to the component itself. Clearance and creepage distances to other components are to be designed in accordance with the relevant application standards.

### SLDF 5.08 L/F..



#### Dimensioned drawing

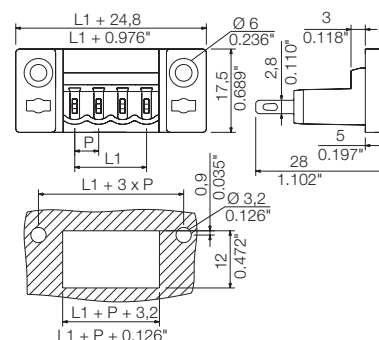

### Technical data

#### In compliance with IEC 60664-1 / IEC 61984

Clamping range, max.			
<b>Solid core H05(07) V-U</b>			
Stranded H07 V-R			
Flexible H05(07) V-K			
Flexible with ferrule			
Ferrule with plastic collar			
Stripping length			
Screwdriver blade	mm		
According to norm			
Tightening torque range			
<b>Rated current, max.</b>	<b>15</b>	<b>13</b>	
At ambient temperature	20°C	40°C	
For conductor cross-section			
Overvoltage category	III	III	II
Pollution severity	3	2	2
<b>Rated voltage</b>	<b>V</b>	<b>250</b>	<b>320</b>
Rated impulse voltage	kV	4	4
<b>UL / CUL (Use Group)</b>	<b>B</b>	<b>C</b>	<b>D</b>
<b>Rated voltage</b>	<b>V</b>	<b>300</b>	<b>300</b>
<b>Rated current</b>	<b>A</b>	<b>10</b>	<b>10</b>
<b>AWG conductor</b>	<b>AWG</b>	-	-
<b>CSA (Use Group)</b>	<b>B</b>	<b>C</b>	<b>D</b>
Rated voltage	V	300	300
Rated current	A	10	10
AWG conductor	AWG	-	-
<b>General data</b>			
Type of insulation material	PBT		
UL 94 flammability rating	V-0		
Contact base material	CuSn		
Material of contact surface	tinned		
Pin dimensions = d	mm		
Solder eyelet Ø = D	mm		
Solder eyelet Ø tolerance	mm		

### Accessories

Note: Refer to the Accessories chapter for additional accessories.

Coding	Order No.
BLZ/SL KO OR BX	<b>1573010000</b>
BLZ/SL KO BK BX	<b>1545710000</b>
<b>Partition element</b>	
SL AT OR	<b>1598300000</b>
SL AT SW	<b>1770240000</b>
<b>Interlock</b>	
SLDF VR BK	<b>1599120000</b>

### Ordering data

Solder pin length				
Colour	Orange			
Pitch	5.08 mm			
Pol.	L1	(inch)	Qty.	Order No.
2	5.08	0.200	100	<b>1599130000</b>
3	10.16	0.400	100	<b>1599140000</b>
4	15.24	0.600	100	<b>1599150000</b>
5	20.32	0.800	50	<b>1599160000</b>
6	25.40	1.000	50	<b>1599170000</b>
7	30.48	1.200	50	<b>1599180000</b>
8	35.56	1.400	50	<b>1599190000</b>
9	40.64	1.600	50	<b>1599200000</b>
10	45.72	1.800	50	<b>1599210000</b>
11	50.80	2.000	50	<b>1599220000</b>
12	55.88	2.200	50	<b>1599230000</b>
13	60.96	2.400	50	<b>1599240000</b>
14	66.04	2.600	50	<b>1599250000</b>
15	71.12	2.800	50	<b>1599260000</b>
16	76.20	3.000	50	<b>1599270000</b>



## Connectors in 5.08 mm pitch Series BL/SL 5.08

### SLS 5.08/./180DF

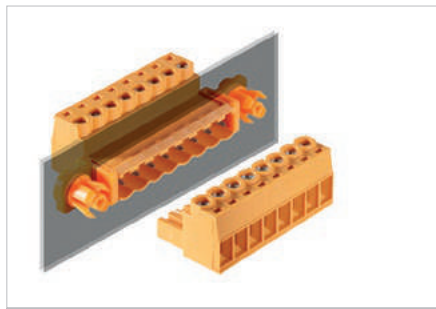

Male plug with clamping yoke/screw connection and straight wire outlet. The male plugs feature space for labelling and can be coded. Packed in a cardboard box.

- SLS 5.08 F & BLZP 5.08 F for wire-to-wire applications as wall or device feed-through
- SLS 5.08 F & BLZP 5.08 F for wire-to-wire applications / flying lead couplings
- SLS 5.08 FI & BLL 5.08 FI for board-to-wire connections (power supply for actuators)
- Folded steel clamping yoke accommodates the connected wire and compensates for temperature fluctuations

### Technical data

In compliance with IEC 60664-1 / IEC 61984			
Clamping range, max.	mm <sup>2</sup>	0.13...3.31	
<b>Solid core H05(07) V-U</b>	<b>mm<sup>2</sup></b>	<b>0.2...2.5</b>	
Stranded H07 V-R			
Flexible H05(07) V-K	mm <sup>2</sup>	0.2...2.5	
Flexible with ferrule	mm <sup>2</sup>	0.2...2.5	
Ferrule with plastic collar	mm <sup>2</sup>	0.2...2.5	
Stripping length	mm	7	
Screwdriver blade	mm	0.6 x 3.5	
According to norm		DIN 5264-A	
Tightening torque range	Nm	0.4...0.5	
<b>Rated current, max.</b>	<b>A</b>	<b>21.5</b>	<b>18</b>
At ambient temperature		20°C	40°C
For conductor cross-section			
Overvoltage category		III	III II
Pollution severity		3	2 2
<b>Rated voltage</b>	<b>V</b>	<b>250</b>	<b>320 400</b>
Rated impulse voltage	kV	4	4 4
<b>UL / CUL (Use Group)</b>	<b>B C D</b>		
<b>Rated voltage</b>	<b>V</b>	<b>300</b>	<b>300</b>
<b>Rated current</b>	<b>A</b>	<b>14</b>	<b>10</b>
<b>AWG conductor</b>	<b>AWG</b>	<b>26-12</b>	
<b>CSA (Use Group)</b>	<b>B C D</b>		
Rated voltage	V	300	300
Rated current	A	15	10
AWG conductor	AWG	26-12	
<b>General data</b>			
Type of insulation material		PBT	
UL 94 flammability rating		V-0	
Contact base material		CuSn	
Material of contact surface		tinned	
Pin dimensions = d	mm		
Solder eyelet Ø = D			
Solder eyelet Ø tolerance	mm		

### Product data

IEC: 400 V / 21.5 A / 0.2 - 2.5 mm<sup>2</sup>  
UL: 300 V / 14 A / AWG 26 - 12



For additional articles and information, refer to [catalog.weidmueller.com](http://catalog.weidmueller.com)

#### Note:

- Additional colours on request
- Rated current related to rated cross-section & min. No. of poles.
- Wire end ferrule without plastic collar to DIN 46228/1
- Wire end ferrule with plastic collar to DIN 46228/4
- P on drawing = pitch
- Rated data refer only to the component itself. Clearance and creepage distances to other components are to be designed in accordance with the relevant application standards.

### SLS 5.08/./180DF



#### Dimensioned drawing

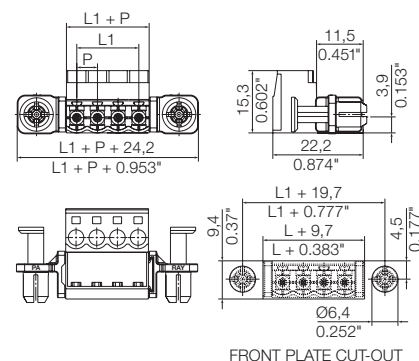

### Accessories

Note: Refer to the Accessories chapter for additional accessories.

Strain relief		Order No.
	BLZ 5.08 ZE04 OR BX	1652110000
	BLZ 5.08 ZE04 BK BX	1652130000
	BLZ 5.08 ZE08 OR BX	1652050000
	BLZ 5.08 ZE08 BK BX	1652070000
Coding		
	BLZ/SL KO QR BX	1573010000
	BLZ/SL KO BK BX	1545710000
Screwdriver		
	SDS 0.6X3.5X100	9008330000
	SDIS 0.6X3.5X100	9008390000
Partition element		
	SL AT OR	1598300000
	SL AT SW	1770240000

### Ordering data

Solder pin length		Orange		
Colour				
Pitch	5.08 mm			
Pol.	L1	(inch)	Qty.	Order No.
2	5.08	0.200	54	1353470000
3	10.16	0.400	42	1353480000
4	15.24	0.600	42	1353490000
5	20.32	0.800	36	1353500000
6	25.40	1.000	30	1353520000
7	30.48	1.200	30	1353530000
8	35.56	1.400	24	1353540000
9	40.64	1.600	24	1353550000
10	45.72	1.800	24	1353570000

### Representative deratings curve

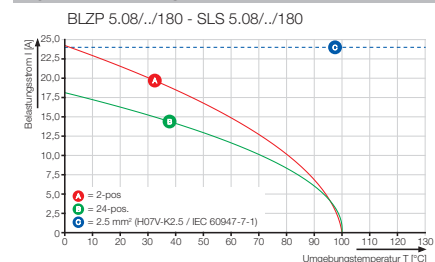

## Flexibility & safety

Maximum flexibility and optimum safety should be guaranteed when designing this equipment.

This application can be made with various connection systems: a TOP connection with a screw, clamping yoke or "PUSH IN". It is necessary to adapt the hole size, as appropriate, to the expanding rivets so that they are able to respond to the thickness of the customers' housing wall whilst still being able to guarantee the highest level of safety. This means we strike just the right balance between easy pin insertion without using a tool and optimum stability and vibration resistance for the entire coupling during the application.

### BBDF sectional drawing in the wall of the housing

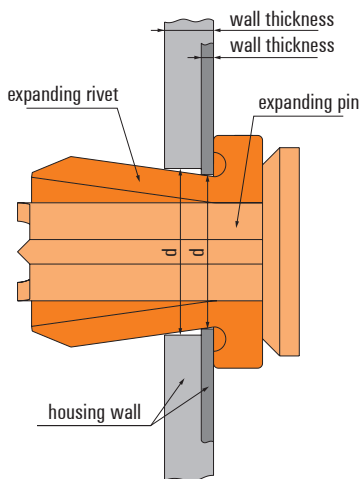

### hole size table

	housing wall thickness	hole size (p)
mm	0.5 - 0.8	6.3
	1	6.4
	1.5	6.5
	2	6.7
inch	0.019 - 0.031	0.248
	0.039	0.252
	0.059	0.256
	0.079	0.264

### assembly description

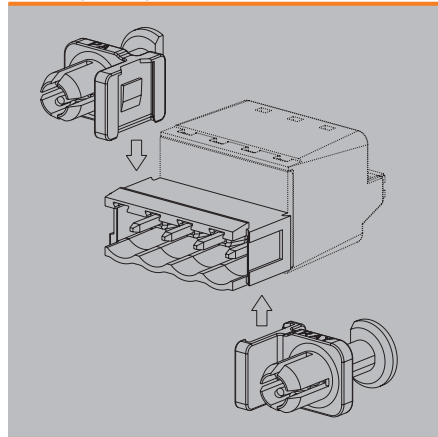

## Connectors in 5.08 mm pitch Series BL/SL 5.08

### SLT 5.08/./180DF

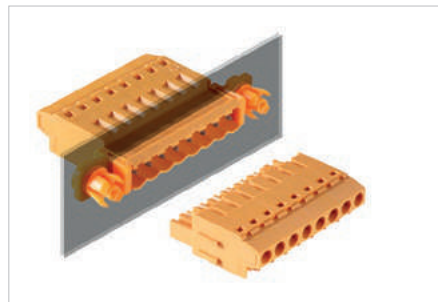

Male plug with clamping yoke/screw connection and straight wire outlet. The male plugs feature space for labelling and can be coded. Packed in a cardboard box.

- SLT 5.08 DF & BLT 5.08 for wire-to-wire applications in the form of wall or device feed-through
- SLT 5.08 F & BLT 5.08 F for wire-to-wire applications / flying lead couplings
- SLT 5.08 FI & BLL 5.08 FI for board-to-wire connections (power supply for actuators)
- Folded steel clamping yoke accommodates the connected wire and compensates for temperature fluctuations.

### Product data

IEC: 400 V / 16 A / 0.2 - 2.5 mm<sup>2</sup>  
UL: 300 V / 15 A / AWG 26 - 14



For additional articles and information, refer to [catalog.weidmueller.com](http://catalog.weidmueller.com)

#### Note:

- Additional colours on request
- Rated current related to rated cross-section & min. No. of poles.
- Wire end ferrule without plastic collar to DIN 46228/1
- Wire end ferrule with plastic collar to DIN 46228/4
- Crimp form A for wire end ferrules with PZ1.5 or PZ 6/5 crimping tool are recommended for the largest cable sizes.
- P on drawing = pitch
- Rated data refer only to the component itself. Clearance and creepage distances to other components are to be designed in accordance with the relevant application standards.

### SLT 5.08/./180DF

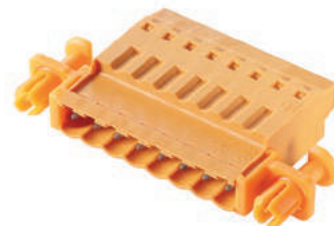

#### Dimensioned drawing

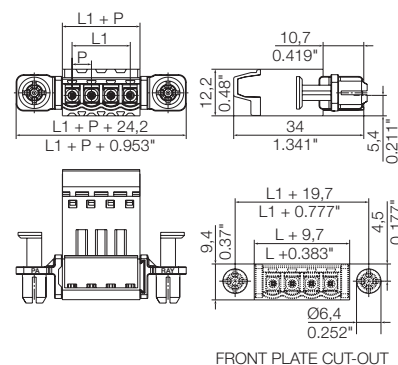

FRONT PLATE CUT-OUT

## G

### Technical data

In compliance with IEC 60664-1 / IEC 61984			
Clamping range, max.	mm <sup>2</sup>	0.13...2.5	
<b>Solid core H05(07) V-U</b>	<b>mm<sup>2</sup></b>	<b>0.2...2.5</b>	
Stranded H07 V-R			
Flexible H05(07) V-K	mm <sup>2</sup>	0.2...1.5	
Flexible with ferrule	mm <sup>2</sup>	0.2...1.5	
Ferrule with plastic collar	mm <sup>2</sup>	0.2...1.5	
Stripping length	mm	13	
Screwdriver blade	mm	0.6 x 3.5	
According to norm		DIN 5264	
Tightening torque range	Nm	0.4...0.5	
<b>Rated current, max.</b>	<b>A</b>	<b>16</b>	<b>13</b>
At ambient temperature		20°C	40°C
For conductor cross-section			
Overvoltage category		III	III II
Pollution severity		3	2 2
<b>Rated voltage</b>	<b>V</b>	<b>250</b>	<b>400 400</b>
Rated impulse voltage	kV	4	4 4
<b>UL / CUL (Use Group)</b>		<b>B</b>	<b>C D</b>
<b>Rated voltage</b>	<b>V</b>	<b>300</b>	<b>300</b>
<b>Rated current</b>	<b>A</b>	<b>15</b>	<b>10</b>
<b>AWG conductor</b>	<b>AWG</b>	<b>26-14</b>	
<b>CSA (Use Group)</b>		<b>B</b>	<b>C D</b>
Rated voltage	V	300	300
Rated current	A	10	10
AWG conductor	AWG	26-14	
<b>General data</b>			
Type of insulation material		PBT	
UL 94 flammability rating		V-0	
Contact base material		CuSn	
Material of contact surface		tinned	
Pin dimensions = d	mm		
Solder eyelet Ø = D			
Solder eyelet Ø tolerance	mm		

### Accessories

Note: Refer to the Accessories chapter for additional accessories.

Coding	Order No.
BLZ/SL KO OR BX	<b>1573010000</b>
BLZ/SL KO BK BX	<b>1545710000</b>
<b>Screwdriver</b>	
SDS 0.6X3.5X100	<b>9008330000</b>
SDIS 0.6X3.5X100	<b>9008390000</b>
<b>Partition element</b>	
SL AT OR	<b>1598300000</b>
SL AT SW	<b>1770240000</b>

### Ordering data

Solder pin length				
Colour	Orange			
Pitch	5.08 mm		Qty.	Order No.
Pol.	L1	(inch)		
2	5.08	0.200	54	<b>1353350000</b>
3	10.16	0.400	42	<b>1353370000</b>
4	15.24	0.600	42	<b>1353380000</b>
5	20.32	0.800	36	<b>1353390000</b>
6	25.40	1.000	30	<b>1353400000</b>
7	30.48	1.200	30	<b>1353420000</b>
8	35.56	1.400	24	<b>1353430000</b>
9	40.64	1.600	24	<b>1353440000</b>
10	45.72	1.800	24	<b>1353450000</b>

## Flexibility & safety

Maximum flexibility and optimum safety should be guaranteed when designing this equipment.

This application can be made with various connection systems: a TOP connection with a screw, clamping yoke or "PUSH IN". It is necessary to adapt the hole size, as appropriate, to the expanding rivets so that they are able respond to the thickness of the customers' housing wall whilst still being able to guarantee the highest level of safety. This means we strike just the right balance between easy pin insertion without using a tool and optimum stability and vibration resistance for the entire coupling during the application.

### BBDF sectional drawing in the wall of the housing

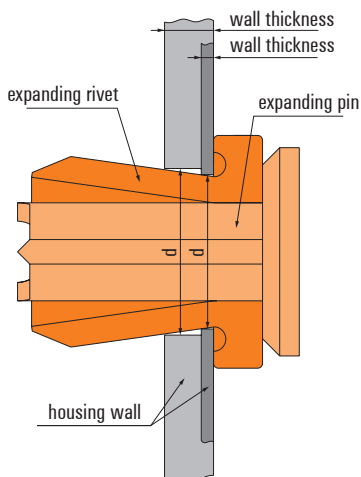

### hole size table

	housing wall thickness	hole size (p)
mm	0.5 - 0.8	6.3
	1	6.4
	1.5	6.5
	2	6.7
inch	0.019 - 0.031	0.248
	0.039	0.252
	0.059	0.256
	0.079	0.264

### assembly description

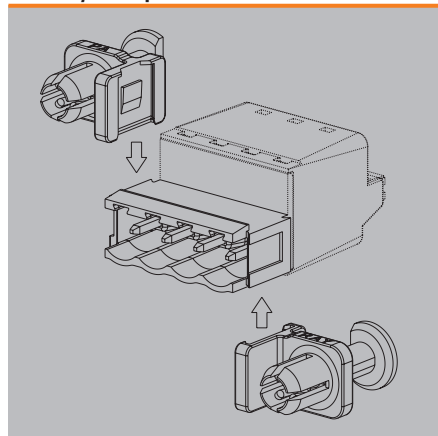

## Connectors in 5.08 mm pitch Series BL/SL 5.08

### SLF 5.08../180DF

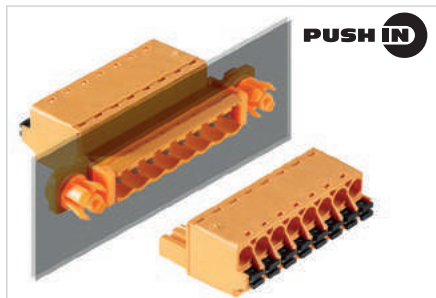

**PUSH IN**

Male plug with PUSH IN wire connection system, with straight wire outlet. The male plugs feature space for labelling and can be coded. Packed in a cardboard box.

- SLF 5.08 DF & BLF 5.08 for wire-to-wire applications in the form of panel or device feed-through)
- SLF 5.08 F & BLF 5.08 F for wire-to-wire applications / flying lead couplings
- SLF 5.08 FI & BLL 5.08 FI for board-to-wire connections (power supply for actuators)

### Technical data

In compliance with IEC 60664-1 / IEC 61984			
Clamping range, max.	mm <sup>2</sup>	0.13...3.31	
<b>Solid core H05(07) V-U</b>	mm <sup>2</sup>	<b>0.2...2.5</b>	
Stranded H07 V-R			
Flexible H05(07) V-K	mm <sup>2</sup>	0.2...2.5	
Flexible with ferrule	mm <sup>2</sup>	0.2...2.5	
Ferrule with plastic collar	mm <sup>2</sup>	0.2...2.5	
Stripping length	mm	10	
Screwdriver blade	mm	0.6 x 3.5	
		According to norm DIN 5264	
Tightening torque range			
<b>Rated current, max.</b>	<b>A</b>	<b>25.9</b>	<b>22.5</b>
At ambient temperature		20°C	40°C
For conductor cross-section	mm <sup>2</sup>	2.5	
Overvoltage category		III	III II
Pollution severity		3	2 2
<b>Rated voltage</b>	<b>V</b>	<b>250</b>	<b>320 400</b>
Rated impulse voltage	kV	4	4 4
<b>UL / CUL (Use Group)</b>		<b>B</b>	<b>C D</b>
<b>Rated voltage</b>	<b>V</b>	<b>300</b>	<b>300</b>
<b>Rated current</b>	<b>A</b>	<b>14</b>	<b>10</b>
<b>AWG conductor</b>	<b>AWG</b>	<b>26-12</b>	
<b>CSA (Use Group)</b>		<b>B</b>	<b>C D</b>
Rated voltage	V	300	300
Rated current	A	10	10
AWG conductor	AWG	26-12	
<b>General data</b>			
Type of insulation material		PBT	
UL 94 flammability rating		V-0	
Contact base material		CuSn	
Material of contact surface		tinned	
Pin dimensions = d	mm		
Solder eyelet Ø = D			
Solder eyelet Ø tolerance	mm		

### Product data

IEC: 400 V / 25.9 A / 0.2 - 2.5 mm<sup>2</sup>  
UL: 300 V / 14 A / AWG 26 - 12



For additional articles and information, refer to [catalog.weidmuller.com](http://catalog.weidmuller.com)

#### Note:

- Additional colours on request
- Gold-plated contact surfaces on request
- Rated current related to rated cross-section & min. No. of poles.
- Wire end ferrule without plastic collar to DIN 46228/1
- Wire end ferrule with plastic collar to DIN 46228/4
- P on drawing = pitch

### SLF 5.08../180DF

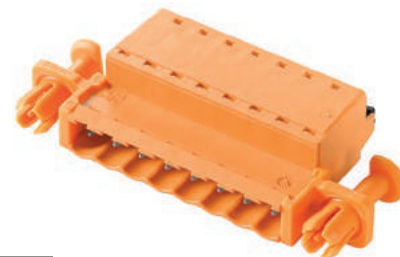

#### Dimensioned drawing

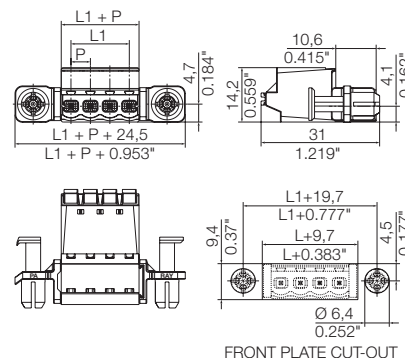

### Accessories

Note: Refer to the Accessories chapter for additional accessories.

Coding	Order No.
BLZ/SL KO OR BX	<b>1573010000</b>
BLZ/SL KO BK BX	<b>1545710000</b>
<b>Screwdriver</b>	
SDS 0.6X3.5X100	<b>9008330000</b>
SDIS 0.6X3.5X100	<b>9008390000</b>
<b>Wire-end ferrule</b>	
H0,5/14S W	<b>9004590000</b>
H1,5/14S SW	<b>9025240000</b>
H2,5/14S BL	<b>1333100000</b>

### Ordering data

Solder pin length				
Colour	Orange			
Pitch	5.08 mm			
Pol.	L1	(inch)	Qty.	Order No.
2	5.08	0.200	54	<b>1353580000</b>
3	10.16	0.400	42	<b>1353590000</b>
4	15.24	0.600	42	<b>1353600000</b>
5	20.32	0.800	36	<b>1353620000</b>
6	25.40	1.000	30	<b>1353630000</b>
7	30.48	1.200	30	<b>1353640000</b>
8	35.56	1.400	24	<b>1353650000</b>
9	40.64	1.600	24	<b>1353670000</b>
10	45.72	1.800	24	<b>1353680000</b>

**G**

**5.08**

**180°**

**2.5 mm<sup>2</sup>**



## Flexibility & safety

Maximum flexibility and optimum safety should be guaranteed when designing this equipment.

This application can be made with various connection systems: a TOP connection with a screw, clamping yoke or "PUSH IN". It is necessary to adapt the hole size, as appropriate, to the expanding rivets so that they are able to respond to the thickness of the customers' housing wall whilst still being able to guarantee the highest level of safety. This means we strike just the right balance between easy pin insertion without using a tool and optimum stability and vibration resistance for the entire coupling during the application.

### BBDF sectional drawing in the wall of the housing

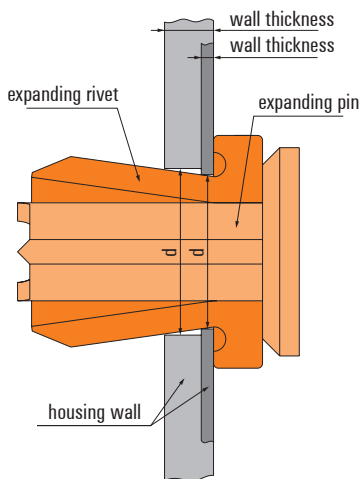

### hole size table

	housing wall thickness	hole size (p)
mm	0.5 - 0.8	6.3
	1	6.4
	1.5	6.5
	2	6.7
inch	0.019 - 0.031	0.248
	0.039	0.252
	0.059	0.256
	0.079	0.264

### assembly description

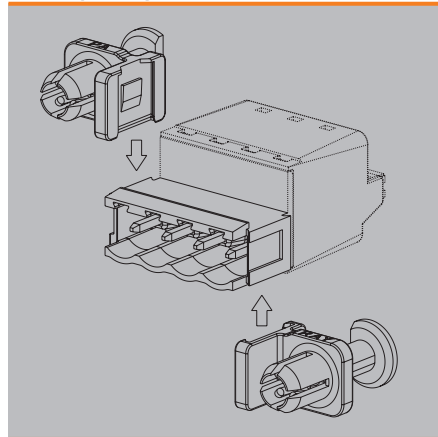

## Connectors in 5.08 mm pitch Series BL/SL 5.08

### BLT 5.08/./180DF

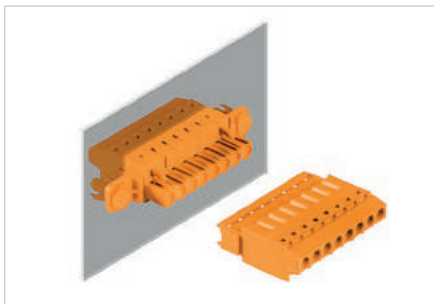

Female plug with clamping-yoke screw connection system and straight wire outlet. The female connectors provide space for labelling and can be coded. Packed in a cardboard box. HC = High Current.

- SLT 5.08 & BLT 5.08HC 180DF for wire-to-wire applications, for wall or device feed-through

### Product data

IEC: 400 V / 27 A / 0.2 - 2.5 mm<sup>2</sup>  
UL: 300 V / 17 A / AWG 26 - 14



For additional articles and information, refer to [catalog.weidmueller.com](http://catalog.weidmueller.com)

#### Note:

- Additional colours on request
- Gold-plated contact surfaces on request
- Rated current related to rated cross-section & min. No. of poles.
- Wire end ferrule without plastic collar to DIN 46228/1
- Wire end ferrule with plastic collar to DIN 46228/4
- P on drawing = pitch

### BLT 5.08/./180DF



#### Dimensioned drawing

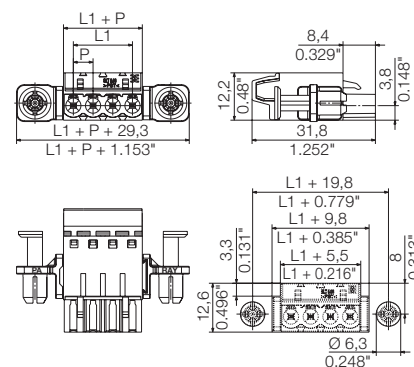

### Technical data

#### In compliance with IEC 60664-1 / IEC 61984

Clamping range, max.	mm <sup>2</sup>	0.13...2.5
<b>Solid core H05(07) V-U</b>	mm <sup>2</sup>	<b>0.2...2.5</b>
Stranded H07 V-R		
Flexible H05(07) V-K	mm <sup>2</sup>	0.2...1.5
Flexible with ferrule	mm <sup>2</sup>	0.2...1.5
Ferrule with plastic collar	mm <sup>2</sup>	0.2...1.5
Stripping length	mm	13
Screwdriver blade	mm	
According to norm		DIN 5264
Tightening torque range	Nm	0.4...0.5
<b>Rated current, max.</b>	<b>A</b>	<b>27 24</b>
At ambient temperature	20°C	40°C
For conductor cross-section	mm <sup>2</sup>	2.5
Overtoltage category		III III II
Pollution severity		3 2 2
<b>Rated voltage</b>	<b>V</b>	<b>250 320 400</b>
Rated impulse voltage	kV	4 4 4
<b>UL / CUL (Use Group)</b>	<b>B C D</b>	
<b>Rated voltage</b>	<b>V</b>	<b>300 300</b>
<b>Rated current</b>	<b>A</b>	<b>17 10</b>
<b>AWG conductor</b>	<b>AWG</b>	<b>26-14</b>
<b>CSA (Use Group)</b>	<b>B C D</b>	
Rated voltage	V	300 300
Rated current	A	15 15
AWG conductor	AWG	26-14
<b>General data</b>		
Type of insulation material		PBT
UL 94 flammability rating		V-0
Contact base material		CuSn
Material of contact surface		tinned
Pin dimensions = d	mm	
Solder eyelet Ø = D		
Solder eyelet Ø tolerance	mm	

### Accessories

Note: Refer to the Accessories chapter for additional accessories.

Coding	Order No.
BLZ/SL KO OR BX	<b>1573010000</b>
BLZ/SL KO BK BX	<b>1545710000</b>
<b>Screwdriver</b>	
SDIS 0.6X3.5X100	<b>9008390000</b>
SDS 0.6X3.5X100	<b>9008330000</b>
<b>Partition element</b>	
SL AT OR	<b>1598300000</b>
SL AT SW	<b>1770240000</b>

### Ordering data

Solder pin length				
Colour	Orange			
Pitch	5.08 mm			
Pol.	L1	(inch)	Qty.	Order No.
2	5.08	0.200	54	<b>1353130000</b>
3	10.16	0.400	42	<b>1353140000</b>
4	15.24	0.600	42	<b>1353150000</b>
5	20.32	0.800	36	<b>1353170000</b>
6	25.40	1.000	30	<b>1353180000</b>
7	30.48	1.200	30	<b>1353190000</b>
8	35.56	1.400	24	<b>1353200000</b>
9	40.64	1.600	24	<b>1353220000</b>
10	45.72	1.800	24	<b>1353230000</b>

## Flexibility & safety

Maximum flexibility and optimum safety should be guaranteed when designing this equipment.

This application can be made with various connection systems: a TOP connection with a screw, clamping yoke or "PUSH IN". It is necessary to adapt the hole size, as appropriate, to the expanding rivets so that they are able to respond to the thickness of the customers' housing wall whilst still being able to guarantee the highest level of safety. This means we strike just the right balance between easy pin insertion without using a tool and optimum stability and vibration resistance for the entire coupling during the application.

### BBDF sectional drawing in the wall of the housing

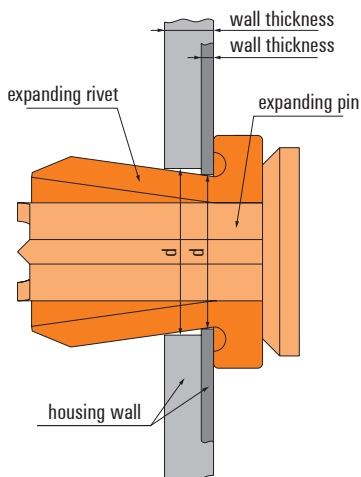

### hole size table

	housing wall thickness	hole size (p)
mm	0.5 - 0.8	6.3
	1	6.4
	1.5	6.5
	2	6.7
inch	0.019 - 0.031	0.248
	0.039	0.252
	0.059	0.256
	0.079	0.264

### assembly description

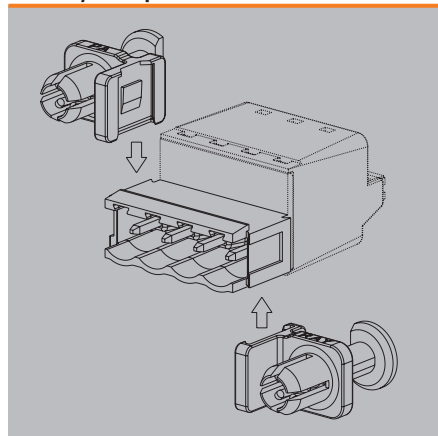

## Connectors in 5.08 mm pitch Series BL/SL 5.08

### BLF 5.08../180DF

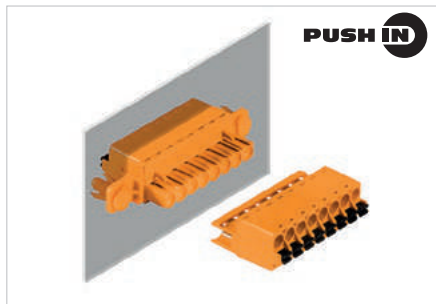

**PUSH IN**

Female plug with PUSH IN wire connection system and straight outlet direction. The female connectors provide space for labelling and can be coded. Packed in a cardboard box. HC = High Current.

- SLF 5.08 & BLF 5.08HC DF for wire-to-wire applications, for wall or device feed-through

### Technical data

In compliance with IEC 60664-1 / IEC 61984			
Clamping range, max.	mm <sup>2</sup>	0.13...3.31	
<b>Solid core H05(07) V-U</b>	mm <sup>2</sup>	<b>0.2...2.5</b>	
Stranded H07 V-R			
Flexible H05(07) V-K	mm <sup>2</sup>	0.2...2.5	
Flexible with ferrule	mm <sup>2</sup>	0.25...2.5	
Ferrule with plastic collar	mm <sup>2</sup>	0.25...2.5	
Stripping length	mm	10	
Screwdriver blade	mm	0.6 x 3.5	
		According to norm DIN 5264	
Tightening torque range			
<b>Rated current, max.</b>	<b>A</b>	<b>24</b>	<b>21</b>
At ambient temperature		20°C	40°C
For conductor cross-section	mm <sup>2</sup>	2.5	
Overvoltage category		III	III II
Pollution severity		3	2 2
<b>Rated voltage</b>	<b>V</b>	<b>250</b>	<b>320 400</b>
Rated impulse voltage	kV	4	4 4
<b>UL / CUL (Use Group)</b>		<b>B</b>	<b>C D</b>
<b>Rated voltage</b>	<b>V</b>	<b>300</b>	<b>300</b>
<b>Rated current</b>	<b>A</b>	<b>18.5</b>	<b>10</b>
<b>AWG conductor</b>	<b>AWG</b>	<b>26-12</b>	
<b>CSA (Use Group)</b>		<b>B</b>	<b>C D</b>
Rated voltage	V	300	300
Rated current	A		10
AWG conductor	AWG	26-12	
<b>General data</b>			
Type of insulation material		PBT	
UL 94 flammability rating		V-0	
Contact base material		CuSn	
Material of contact surface		tinned	
Pin dimensions = d	mm		
Solder eyelet Ø = D			
Solder eyelet Ø tolerance	mm		

### Product data

IEC: 400 V / 24 A / 0.2 - 2.5 mm<sup>2</sup>  
UL: 300 V / 18.5 A / AWG 26 - 12



For additional articles and information, refer to [catalog.weidmueller.com](http://catalog.weidmueller.com)

#### Note:

- Additional colours on request
- Gold-plated contact surfaces on request
- Rated current related to rated cross-section & min. No. of poles.
- Wire end ferrule without plastic collar to DIN 46228/1
- Wire end ferrule with plastic collar to DIN 46228/4
- P on drawing = pitch

### BLF 5.08../180DF



#### Dimensioned drawing

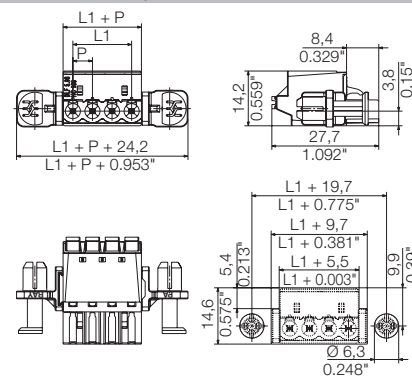

### Accessories

Note: Refer to the Accessories chapter for additional accessories.

Coding	Order No.
BLZ/SL KO OR BX	<b>1573010000</b>
BLZ/SL KO BK BX	<b>1545710000</b>
Screwdriver	
SDIS 0.6X3.5X100	<b>9008390000</b>
SDS 0.6X3.5X100	<b>9008330000</b>
Wire-end ferrule	
H0,5/14S W	<b>9004590000</b>
H1,5/14S SW	<b>9025240000</b>
H2,5/14S BL	<b>1333100000</b>

### Ordering data

Solder pin length				
Colour	Orange			
Pitch	5.08 mm			
Pol.	L1	(inch)	Qty.	Order No.
2	5.08	0.200	54	<b>1353240000</b>
3	10.16	0.400	42	<b>1353250000</b>
4	15.24	0.600	42	<b>1353270000</b>
5	20.32	0.800	36	<b>1353280000</b>
6	25.40	1.000	30	<b>1353340000</b>
7	30.48	1.200	30	<b>1353290000</b>
8	35.56	1.400	24	<b>1353300000</b>
9	40.64	1.600	24	<b>1353320000</b>
10	45.72	1.800	24	<b>1353330000</b>

### Flexibility & safety

Maximum flexibility and optimum safety should be guaranteed when designing this equipment.

This application can be made with various connection systems: a TOP connection with a screw, clamping yoke or "PUSH IN". It is necessary to adapt the hole size, as appropriate, to the expanding rivets so that they are able to respond to the thickness of the customers' housing wall whilst still being able to guarantee the highest level of safety. This means we strike just the right balance between easy pin insertion without using a tool and optimum stability and vibration resistance for the entire coupling during the application.

### BBDF sectional drawing in the wall of the housing

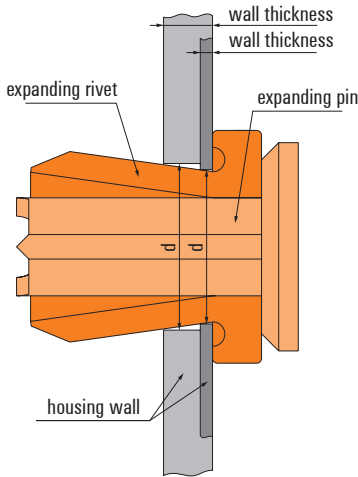

### hole size table

	housing wall thickness	hole size (p)
mm	0.5 - 0.8	6.3
	1	6.4
	1,5	6.5
	2	6.7
inch	0.019 - 0.031	0.248
	0.039	0.252
	0.059	0.256
	0.079	0.264

### assembly description

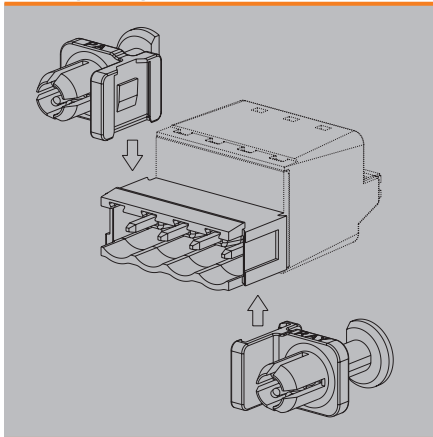

### PUSH IN connection technology

"PUSH IN" connection technology reduces the wiring affords especially for solid wires and wires with ferrule to a minimum. These connectors are self-explanatory and enable tool-less handling. The contact element made of stainless steel ensures a vibration proofed, maintenance free wire termination. The established principle "STEEL FOR THE FORCE, COPPER FOR THE CURRENT" by Weidmüller offers both, maximum conductor clamping forces, as well as minimum power loss at the same time.



### The 2-in-1 contact

Every pluggable connector covers two contact points and thus must meet two different requirements: First, the wire termination and second, the connection between plug and pin header. Referring to the 5.0x pitch series, Weidmüller offers different wire connection technologies, but one platform contact for the male / female connection since years. This well-designed hybride platform contact ensures a constant quality on a very high level. Hybride means, that we combine metal material featuring different characteristics by welding, in order to divide the contact system into different function zones: Further to the high electric conductance, the current bar is characterized by its hardness, and the tulip contact by its excellent tension properties. The advantage: each function is supported by the most suitable material to reliably and constantly meet the different electrical and mechanical requirements. To put it in a nutshell: Instead of either ... or, it's even both - perfect for the current, and perfect for the force.



## Connectors in 5.08 mm pitch Series BL/SL 5.08

### SLS 5.08../180

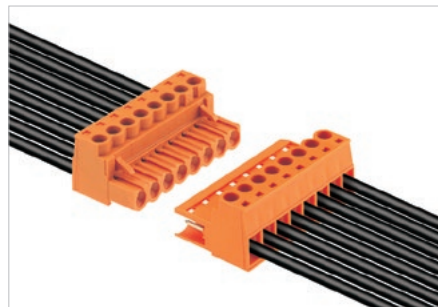

Male plug with clamping yoke screw connection and straight wire outlet. The male plugs provide space for labelling and can be coded. Packed in cardboard box.

- SLS 5.08 F & BLZP 5.08 F for wire-to-wire applications / flying lead couplings
- SLS 5.08 FI & BLL 5.08 FI for board-to-wire connections (power supply for actuators)
- Folded steel clamping yoke accommodates the connected wire and compensates for temperature fluctuations

### Product data

IEC: 400 V / 21.5 A / 0.2 - 2.5 mm<sup>2</sup>  
UL: 300 V / 14 A / AWG 26 - 12



For additional articles and information, refer to [catalog.weidmueller.com](http://catalog.weidmueller.com)

#### Note:

- Additional colours on request
- Rated current related to rated cross-section & min. No. of poles.
- Wire end ferrule without plastic collar to DIN 46228/1
- Wire end ferrule with plastic collar to DIN 46228/4
- P on drawing = pitch
- Rated data refer only to the component itself. Clearance and creepage distances to other components are to be designed in accordance with the relevant application standards.

### SLS 5.08../180



#### Dimensioned drawing

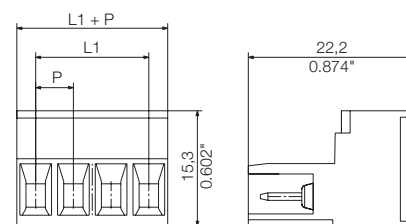

### Technical data

#### In compliance with IEC 60664-1 / IEC 61984

Clamping range, max.	mm <sup>2</sup>	0.13...3.31		
<b>Solid core H05(07) V-U</b>	<b>mm<sup>2</sup></b>	<b>0.2...2.5</b>		
Stranded H07 V-R				
Flexible H05(07) V-K	mm <sup>2</sup>	0.2...2.5		
Flexible with ferrule	mm <sup>2</sup>	0.2...2.5		
Ferrule with plastic collar	mm <sup>2</sup>	0.2...2.5		
Stripping length	mm	7		
Screwdriver blade	mm	0.6 x 3.5		
According to norm		DIN 5264-A		
Tightening torque range	Nm	0.4...0.5		
<b>Rated current, max.</b>	<b>A</b>	<b>21.5</b>	<b>18</b>	<b>18</b>
At ambient temperature		20°C	40°C	40°C
For conductor cross-section				
Overvoltage category		III	III	II
Pollution severity		3	2	2
<b>Rated voltage</b>	<b>V</b>	<b>250</b>	<b>320</b>	<b>400</b>
Rated impulse voltage	kV	4	4	4
<b>UL / CUL (Use Group)</b>	<b>B C D</b>	<b>B</b>	<b>C</b>	<b>D</b>
<b>Rated voltage</b>	<b>V</b>	<b>300</b>	<b>300</b>	<b>300</b>
<b>Rated current</b>	<b>A</b>	<b>14</b>	<b>10</b>	<b>10</b>
<b>AWG conductor</b>	<b>AWG</b>	<b>26-12</b>		
<b>CSA (Use Group)</b>	<b>B C D</b>	<b>B</b>	<b>C</b>	<b>D</b>
Rated voltage	V	300	300	300
Rated current	A	15	10	10
AWG conductor	AWG	26-12		

#### General data

Type of insulation material		PBT
UL 94 flammability rating		
Contact base material		CuSn
Material of contact surface		tinned
Pin dimensions = d	mm	
Solder eyelet Ø = D	mm	
Solder eyelet Ø tolerance	mm	

### Accessories

Note: Refer to the Accessories chapter for additional accessories.

Strain relief		Order No.
	BLZ 5.08 ZE04 OR BX	1652110000
	BLZ 5.08 ZE04 BK BX	1652130000
	BLZ 5.08 ZE08 OR BX	1652050000
	BLZ 5.08 ZE08 BK BX	1652070000
Coding		
	BLZ/SL KO QR BX	1573010000
	BLZ/SL KO BK BX	1545710000
Screwdriver		
	SDS 0.6X3.5X100	9008330000
	SDIS 0.6X3.5X100	9008390000
Partition element		
	SL AT OR	1598300000
	SL AT SW	1770240000
Mounting block		
	SLA BB11R OR	1604120000
	SLA BB11R SW	1692340000

### Ordering data

Solder pin length		Orange		
Colour				
Pitch	5.08 mm			
Pol.	L1 (inch)	Qty.	Order No.	
2	5.08	0.200	180	1627090000
3	10.16	0.400	120	1627100000
4	15.24	0.600	90	1627110000
5	20.32	0.800	72	1627120000
6	25.40	1.000	60	1627130000
7	30.48	1.200	48	1627140000
8	35.56	1.400	42	1627150000
9	40.64	1.600	36	1627160000
10	45.72	1.800	36	1627170000
11	50.80	2.000	30	1627180000
12	55.88	2.200	30	1627190000
13	60.96	2.400	24	1627200000
14	66.04	2.600	24	1627210000
15	71.12	2.800	24	1627220000
16	76.20	3.000	18	1627230000
17	81.28	3.200	18	1644840000
18	86.36	3.400	18	1644850000
19	91.44	3.600	18	1644860000
20	96.52	3.800	18	1644870000
21	101.60	4.000	12	1644880000
22	106.68	4.200	12	1644890000
23	111.76	4.400	12	1644900000
24	116.84	4.600	12	1644910000

### Representative deratings curve



SLS 5.08../180B



Dimensioned drawing

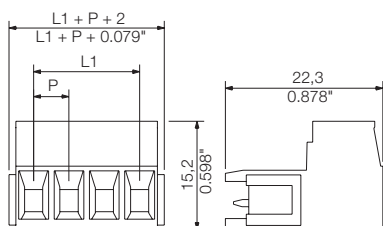

SLS 5.08../180F



Dimensioned drawing

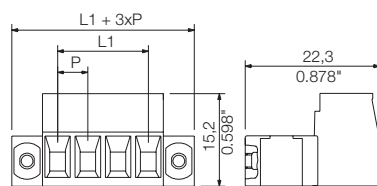

SLS 5.08../180FI



Dimensioned drawing

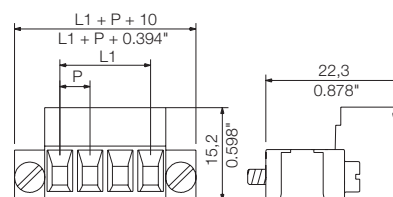

Ordering data

Solder pin length					
Colour					Orange
Pitch 5.08 mm					
Pol.	L1	(inch)	Qty.	Order No.	
2	5.08	0.200	150	1627240000	
3	10.16	0.400	108	1627250000	
4	15.24	0.600	84	1627260000	
5	20.32	0.800	66	1627270000	
6	25.40	1.000	54	1627280000	
7	30.48	1.200	48	1627290000	
8	35.56	1.400	42	1627300000	
9	40.64	1.600	36	1627310000	
10	45.72	1.800	30	1627320000	
11	50.80	2.000	30	1627330000	
12	55.88	2.200	24	1627340000	
13	60.96	2.400	24	1627350000	
14	66.04	2.600	24	1627360000	
15	71.12	2.800	24	1627370000	
16	76.20	3.000	18	1627380000	
17	81.28	3.200	18	1645150000	
18	86.36	3.400	18	1645160000	
19	91.44	3.600	18	1645170000	
20	96.52	3.800	18	1645180000	
21	101.60	4.000	12	1645190000	
22	106.68	4.200	12	1645200000	
23	111.76	4.400	12	1645210000	
24	116.84	4.600	12	1645220000	

Ordering data

Solder pin length					
Colour					Orange
Pitch 5.08 mm					
Pol.	L1	(inch)	Qty.	Order No.	
2	5.08	0.200	90	1846360000	
3	10.16	0.400	72	1846370000	
4	15.24	0.600	60	1846380000	
5	20.32	0.800	48	1846390000	
6	25.40	1.000	42	1846400000	
7	30.48	1.200	36	1846410000	
8	35.56	1.400	36	1846420000	
9	40.64	1.600	30	1846430000	
10	45.72	1.800	30	1846440000	
11	50.80	2.000	24	1846450000	
12	55.88	2.200	24	1846460000	
13	60.96	2.400	24	1846470000	
14	66.04	2.600	18	1846480000	
15	71.12	2.800	18	1846490000	
16	76.20	3.000	18	1846500000	

Ordering data

Solder pin length					
Colour					Orange
Pitch 5.08 mm					
Pol.	L1	(inch)	Qty.	Order No.	
2	5.08	0.200	90	1846210000	
3	10.16	0.400	72	1846220000	
4	15.24	0.600	60	1846230000	
5	20.32	0.800	48	1846240000	
6	25.40	1.000	42	1846250000	
7	30.48	1.200	36	1846260000	
8	35.56	1.400	36	1846270000	
9	40.64	1.600	30	1846280000	
10	45.72	1.800	30	1846290000	
11	50.80	2.000	24	1846300000	
12	55.88	2.200	24	1846310000	
13	60.96	2.400	24	1846320000	
14	66.04	2.600	18	1846330000	
15	71.12	2.800	18	1846340000	
16	76.20	3.000	18	1846350000	

Additional deratings curves

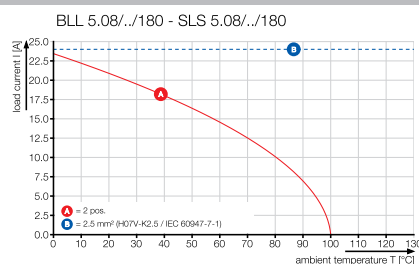
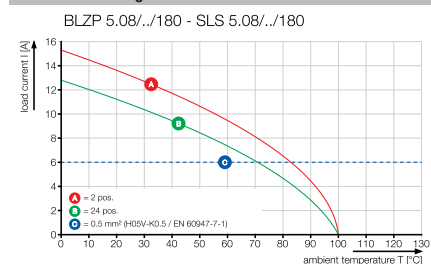

## Connectors in 5.08 mm pitch Series BL/SL 5.08

### SLS 5.08../180TB RF15



Male plug with clamping yoke screw connection and straight wire outlet. The male plug provides space for labelling and can be coded.

- The clip-on foot makes it easy to attach to the DIN rail (TS15).
- SLS 5.08 F & BLZP 5.08 F for wire-to-wire applications (flying lead assemblies)
- Folded steel clamping yoke accommodates the connected wire and compensates for temperature fluctuations

### Product data

IEC: 400 V / 21.5 A / 0.2 - 2.5 mm<sup>2</sup>  
UL: 300 V / 14 A / AWG 26 - 12



For additional articles and information, refer to [catalog.weidmueller.com](http://catalog.weidmueller.com)

#### Note:

- Additional colours on request
- Rated current related to rated cross-section & min. No. of poles.
- Wire end ferrule without plastic collar to DIN 46228/1
- Wire end ferrule with plastic collar to DIN 46228/4
- P on drawing = pitch
- Rated data refer only to the component itself. Clearance and creepage distances to other components are to be designed in accordance with the relevant application standards.

### SLS 5.08../180TB RF15



#### Dimensioned drawing

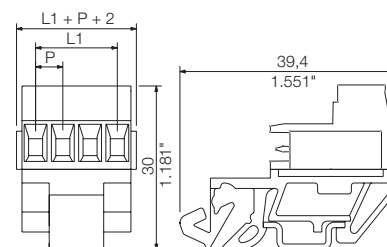

### Technical data

#### In compliance with IEC 60664-1 / IEC 61984

Clamping range, max.	mm <sup>2</sup>	0.13...3.31	
<b>Solid core H05(07) V-U</b>	<b>mm<sup>2</sup></b>	<b>0.2...2.5</b>	
Stranded H07 V-R			
Flexible H05(07) V-K	mm <sup>2</sup>	0.2...2.5	
Flexible with ferrule	mm <sup>2</sup>	0.2...2.5	
Ferrule with plastic collar	mm <sup>2</sup>	0.2...2.5	
Stripping length	mm	7	
Screwdriver blade	mm	0.6 x 3.5	
According to norm		DIN 5264	
Tightening torque range	Nm	0.4...0.5	
<b>Rated current, max.</b>	<b>A</b>	<b>21.5</b>	<b>18</b>
At ambient temperature		20°C	40°C
For conductor cross-section			
Overvoltage category		III	III II
Pollution severity		3	2 2
<b>Rated voltage</b>	<b>V</b>	<b>250</b>	<b>320 400</b>
Rated impulse voltage	kV	4	4 4
<b>UL / CUL (Use Group)</b>		<b>B</b>	<b>C D</b>
<b>Rated voltage</b>	<b>V</b>	<b>300</b>	<b>300</b>
<b>Rated current</b>	<b>A</b>	<b>14</b>	<b>10</b>
<b>AWG conductor</b>	<b>AWG</b>	<b>26-12</b>	
<b>CSA (Use Group)</b>		<b>B</b>	<b>C D</b>
Rated voltage	V	300	300
Rated current	A	15	10
AWG conductor	AWG	26-12	
<b>General data</b>			
Type of insulation material		PBT	
UL 94 flammability rating		V-0	
Contact base material		CuSn	
Material of contact surface		tinned	
Pin dimensions = d	mm		
Solder eyelet Ø = D	mm		
Solder eyelet Ø tolerance	mm		

### Accessories

Note: Refer to the Accessories chapter for additional accessories.

Coding	Order No.
BLZ/SL KO OR BX	<b>1573010000</b>
BLZ/SL KO BK BX	<b>1545710000</b>
<b>Screwdriver</b>	
SDS 0.6X3.5X100	<b>9008330000</b>
SDIS 0.6X3.5X100	<b>9008390000</b>
<b>Partition element</b>	
SL AT OR	<b>1598300000</b>
SL AT SW	<b>1770240000</b>
<b>Mounting block</b>	
SLA BB8 RH OR	<b>1446060000</b>
SLA BB4 OR	<b>1571720000</b>

### Ordering data

Solder pin length				
Colour	Orange			
Pitch	5.08 mm		Qty.	Order No.
Pol.	L1	(inch)		
4	15.24	0.600	20	<b>1846050000</b>
6	25.40	1.000	20	<b>1846060000</b>
8	35.56	1.400	10	<b>1846070000</b>
10	45.72	1.800	10	<b>1846080000</b>
12	55.88	2.200	10	<b>1846090000</b>
16	76.20	3.000	5	<b>1846100000</b>
20	96.52	3.800	5	<b>1846110000</b>
24	116.84	4.600	5	<b>1846120000</b>

### Representative deratings curve

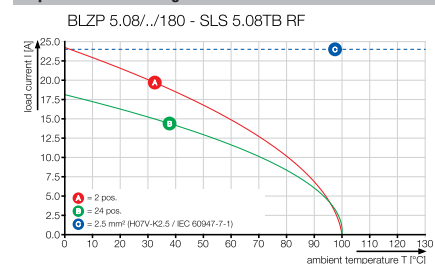



### SLS 5.08../180TB KF35

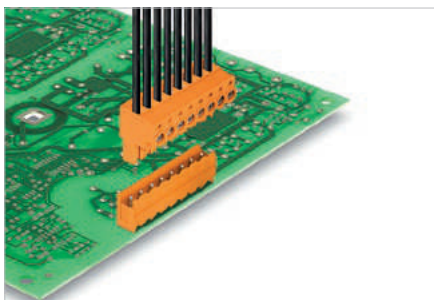

Male plug with clamping yoke screw connection and straight wire outlet. The male plug provides space for labelling and can be coded.

- The clip-on foot makes it easy to attach to the DIN rail (TS32 / TS35).
- SLS 5.08 F & BLZP 5.08 F for wire-to-wire applications (flying lead assemblies)
- Folded steel clamping yoke accommodates the connected wire and compensates for temperature fluctuations

### Technical data

#### In compliance with IEC 60664-1 / IEC 61984

Clamping range, max.	mm <sup>2</sup>	0.13...3.31	
<b>Solid core H05(07) V-U</b>	<b>mm<sup>2</sup></b>	<b>0.2...2.5</b>	
Stranded H07 V-R			
Flexible H05(07) V-K	mm <sup>2</sup>	0.2...2.5	
Flexible with ferrule	mm <sup>2</sup>	0.2...2.5	
Ferrule with plastic collar	mm <sup>2</sup>	0.2...2.5	
Stripping length	mm	7	
Screwdriver blade	mm	0.6 x 3.5	
According to norm		DIN 5264	
Tightening torque range	Nm	0.4...0.5	
<b>Rated current, max.</b>	<b>A</b>	<b>21.5</b>	<b>18</b>
At ambient temperature		20°C	40°C
For conductor cross-section			
Overvoltage category		III	III II
Pollution severity		3	2 2
<b>Rated voltage</b>	<b>V</b>	<b>250</b>	<b>320 400</b>
Rated impulse voltage	kV	4	4 4
<b>UL / CUL (Use Group)</b>		<b>B</b>	<b>C D</b>
<b>Rated voltage</b>	<b>V</b>	<b>300</b>	<b>300</b>
<b>Rated current</b>	<b>A</b>	<b>14</b>	<b>10</b>
<b>AWG conductor</b>	<b>AWG</b>	<b>26-12</b>	
<b>CSA (Use Group)</b>		<b>B</b>	<b>C D</b>
Rated voltage	V	300	300
Rated current	A	15	10
AWG conductor	AWG	26-12	

#### General data

Type of insulation material		PBT
UL 94 flammability rating		V-0
Contact base material		CuSn
Material of contact surface		tinned
Pin dimensions = d	mm	
Solder eyelet Ø = D	mm	
Solder eyelet Ø tolerance	mm	

### Product data

IEC: 400 V / 21.5 A / 0.2 - 2.5 mm<sup>2</sup>  
UL: 300 V / 14 A / AWG 26 - 12



For additional articles and information, refer to [catalog.weidmuller.com](http://catalog.weidmuller.com)

#### Note:

- Additional colours on request
- Rated current related to rated cross-section & min. No. of poles.
- Wire end ferrule without plastic collar to DIN 46228/1
- Wire end ferrule with plastic collar to DIN 46228/4
- P on drawing = pitch
- Rated data refer only to the component itself. Clearance and creepage distances to other components are to be designed in accordance with the relevant application standards.

### SLS 5.08../180TB KF35



#### Dimensioned drawing

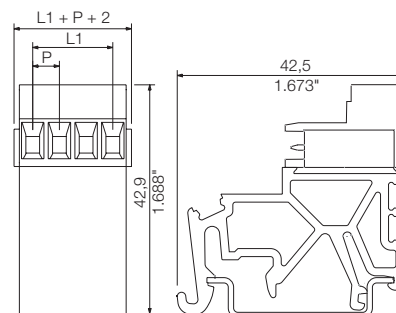

### Accessories

Note: Refer to the Accessories chapter for additional accessories.

Coding	Order No.
BLZ/SL KO OR BX	<b>1573010000</b>
BLZ/SL KO BK BX	<b>1545710000</b>
Screwdriver	
SDS 0.6X3.5X100	<b>9008330000</b>
SDIS 0.6X3.5X100	<b>9008390000</b>
Partition element	
SL AT OR	<b>1598300000</b>
SL AT SW	<b>1770240000</b>
Mounting block	
SLA BB8 RH OR	<b>1446060000</b>
SLA BB4 OR	<b>1571720000</b>

### Ordering data

Solder pin length				
Colour	Orange			
Pitch	5.08 mm			
Pol.	L1	(inch)	Qty.	Order No.
4	15.24	0.600	20	<b>1846130000</b>
6	25.40	1.000	20	<b>1846140000</b>
8	35.56	1.400	10	<b>1846150000</b>
10	45.72	1.800	10	<b>1846160000</b>
12	55.88	2.200	10	<b>1846170000</b>
16	76.20	3.000	5	<b>1846180000</b>
20	96.52	3.800	5	<b>1846190000</b>
24	116.84	4.600	5	<b>1846200000</b>

### Representative deratings curve

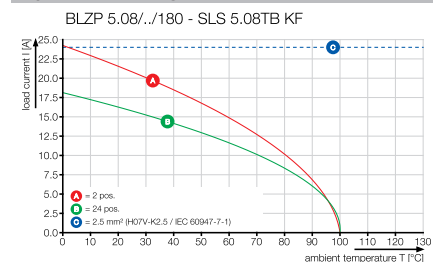

## Connectors in 5.08 mm pitch Series BL/SL 5.08

### SLT 5.08/./180B

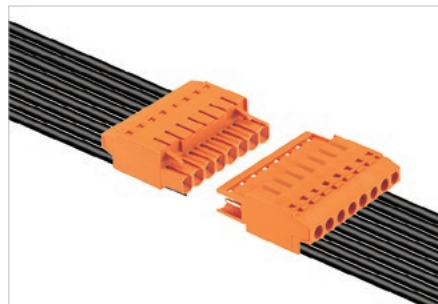

Male plug with TOP screw connection, with straight wire outlet. The male plug provides space for labelling and can be coded.

- SLT 5.08 & BLT 5.08 for wire-to-wire applications (flying lead assemblies)
- SLT 5.08 & BLL 5.08 for board-to-board connections (e.g., power supply for actuators)
- The specialist for cramped installations
- The extra flat shape allows for dense component assembly.
- The screw connect and the cable entry are located on the same side of the connector.

### Product data

IEC: 400 V / 16 A / 0.2 - 2.5 mm<sup>2</sup>  
UL: 300 V / 15 A / AWG 26 - 14



For additional articles and information, refer to [catalog.weidmueller.com](http://catalog.weidmueller.com)

#### Note:

- Additional colours on request
- Rated current related to rated cross-section & min. No. of poles.
- Wire end ferrule without plastic collar to DIN 46228/1
- Wire end ferrule with plastic collar to DIN 46228/4
- Crimp form A for wire end ferrules with PZ 6/5 crimping tool are recommended for the largest cable sizes.
- P on drawing = pitch
- Rated data refer only to the component itself. Clearance and creepage distances to other components are to be designed in accordance with the relevant application standards.

### SLT 5.08/./180B



#### Dimensioned drawing

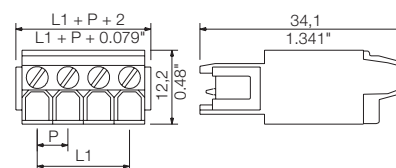

## G

### Technical data

In compliance with IEC 60664-1 / IEC 61984			
Clamping range, max.	mm <sup>2</sup>	0.13...2.5	
<b>Solid core H05(07) V-U</b>	<b>mm<sup>2</sup></b>	<b>0.2...2.5</b>	
Stranded H07 V-R			
Flexible H05(07) V-K	mm <sup>2</sup>	0.2...1.5	
Flexible with ferrule	mm <sup>2</sup>	0.2...1.5	
Ferrule with plastic collar	mm <sup>2</sup>	0.2...1.5	
Stripping length	mm	13	
Screwdriver blade	mm	0.6 x 3.5	
According to norm		DIN 5264	
Tightening torque range	Nm	0.4...0.5	
<b>Rated current, max.</b>	<b>A</b>	<b>16</b>	<b>13</b>
At ambient temperature	20°C	40°C	
For conductor cross-section			
Overvoltage category		III	III II
Pollution severity		3	2 2
<b>Rated voltage</b>	<b>V</b>	<b>250</b>	<b>400 400</b>
Rated impulse voltage	kV	4	4 4
<b>UL / CUL (Use Group)</b>		<b>B</b>	<b>C D</b>
<b>Rated voltage</b>	<b>V</b>	<b>300</b>	<b>300</b>
<b>Rated current</b>	<b>A</b>	<b>15</b>	<b>10</b>
<b>AWG conductor</b>	<b>AWG</b>	<b>26-14</b>	
<b>CSA (Use Group)</b>		<b>B</b>	<b>C D</b>
Rated voltage	V	300	300
Rated current	A	10	10
AWG conductor	AWG	26-14	
<b>General data</b>			
Type of insulation material		PBT	
UL 94 flammability rating		V-0	
Contact base material		CuSn	
Material of contact surface		tinned	
Pin dimensions = d	mm		
Solder eyelet Ø = D	mm		
Solder eyelet Ø tolerance	mm		

### Accessories

Note: Refer to the Accessories chapter for additional accessories.

Coding	Order No.
BLZ/SL KO OR BX	1573010000
BLZ/SL KO BK BX	1545710000
<b>Screwdriver</b>	
SDS 0.6X3.5X100	9008330000
SDIS 0.6X3.5X100	9008390000
<b>Partition element</b>	
SL AT OR	1598300000
SL AT SW	1770240000
<b>Mounting block</b>	
SLA BB11R OR	1604120000
SLA BB11R SW	1692340000

### Ordering data

Solder pin length				
Colour	Orange			
Pitch	5.08 mm			
Pol.	L1	(inch)	Qty.	Order No.
2	5.08	0.200	100	1611710000
3	10.16	0.400	100	1611720000
4	15.24	0.600	100	1611730000
5	20.32	0.800	50	1611740000
6	25.40	1.000	50	1611750000
7	30.48	1.200	50	1611760000
8	35.56	1.400	50	1611770000
9	40.64	1.600	50	1611780000
10	45.72	1.800	50	1611790000
11	50.80	2.000	50	1611800000
12	55.88	2.200	50	1611810000
13	60.96	2.400	50	1611820000
14	66.04	2.600	50	1611830000
15	71.12	2.800	50	1611840000
16	76.20	3.000	50	1611850000

### Representative deratings curve

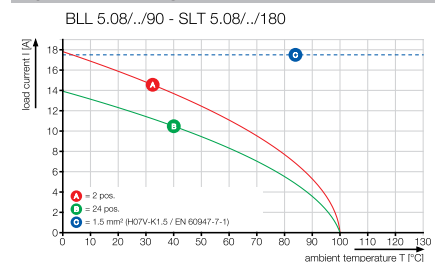



## Connectors in 5.08 mm pitch Series BL/SL 5.08

### SLF 5.08



**PUSH IN**

Male plug with PUSH IN wire connection system, with straight wire outlet. The male plugs feature space for labelling and can be coded. Packed in a cardboard box.

- SLF 5.08 DF & BLF 5.08 for wire-to-wire applications in the form of panel or device feed-through)
- SLF 5.08 F & BLF 5.08 F for wire-to-wire applications / flying lead couplings
- SLF 5.08 FI & BLL 5.08 FI for board-to-wire connections (power supply for actuators)

### Technical data

In compliance with IEC 60664-1 / IEC 61984			
Clamping range, max.	mm <sup>2</sup>	0.13...3.31	
<b>Solid core H05(07) V-U</b>	mm <sup>2</sup>	<b>0.2...2.5</b>	
Stranded H07 V-R			
Flexible H05(07) V-K	mm <sup>2</sup>	0.2...2.5	
Flexible with ferrule	mm <sup>2</sup>	0.2...2.5	
Ferrule with plastic collar	mm <sup>2</sup>	0.2...2.5	
Stripping length	mm	10	
Screwdriver blade	mm	0.6 x 3.5	
		According to norm DIN 5264	
Tightening torque range			
<b>Rated current, max.</b>	<b>A</b>	<b>25.9</b>	<b>22.5</b>
At ambient temperature	20°C	40°C	
For conductor cross-section	mm <sup>2</sup>	2.5	
Overvoltage category		III	II
Pollution severity		3	2
<b>Rated voltage</b>	<b>V</b>	<b>250</b>	<b>320</b>
Rated impulse voltage	kV	4	4
<b>UL / CUL (Use Group)</b>		<b>B</b>	<b>C</b>
<b>Rated voltage</b>	<b>V</b>	<b>300</b>	<b>300</b>
<b>Rated current</b>	<b>A</b>	<b>14</b>	<b>10</b>
<b>AWG conductor</b>	<b>AWG</b>	<b>26-12</b>	
<b>CSA (Use Group)</b>		<b>B</b>	<b>C</b>
Rated voltage	V	300	300
Rated current	A	10	10
AWG conductor	AWG	26-12	
<b>General data</b>			
Type of insulation material		PBT	
UL 94 flammability rating		V-0	
Contact base material		CuSn	
Material of contact surface		tinned	
Pin dimensions = d	mm		
Solder eyelet Ø = D			
Solder eyelet Ø tolerance	mm		

### Product data

IEC: 400 V / 25.9 A / 0.2 - 2.5 mm<sup>2</sup>  
UL: 300 V / 14 A / AWG 26 - 12



For additional articles and information, refer to [catalog.weidmuller.com](http://catalog.weidmuller.com)

#### Note:

- Additional colours on request
- Gold-plated contact surfaces on request
- Rated current related to rated cross-section & min. No. of poles.
- Wire end ferrule without plastic collar to DIN 46228/1
- Wire end ferrule with plastic collar to DIN 46228/4
- P on drawing = pitch

### SLF 5.08../180



#### Dimensioned drawing

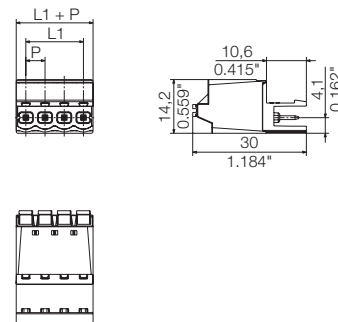

### Ordering data

Solder pin length				
Colour	Orange			
Pitch	5.08 mm		Qty.	Order No.
Pol.	L1	(inch)		
2	5.08	0.200	180	1335330000
3	10.16	0.400	120	1335340000
4	15.24	0.600	90	1335350000
5	20.32	0.800	72	1335360000
6	25.40	1.000	60	1335370000
7	30.48	1.200	48	1335380000
8	35.56	1.400	42	1335390000
9	40.64	1.600	36	1335400000
10	45.72	1.800	36	1335410000
11	50.80	2.000	30	1335420000
12	55.88	2.200	30	1335430000

### Accessories

Note: Refer to the Accessories chapter for additional accessories.

Coding	Order No.
BLZ/SL KO OR BX	1573010000
BLZ/SL KO BK BX	1545710000
Screwdriver	
SDS 0.6X3.5X100	9008330000
SDIS 0.6X3.5X100	9008390000
Wire-end ferrule	
H0,5/14S W	9004590000
H1,0/14S R	9018560000
H1,5/14S SW	9025240000
H2,5/14S BL	1333100000

SLF 5.08/./180B



Dimensioned drawing

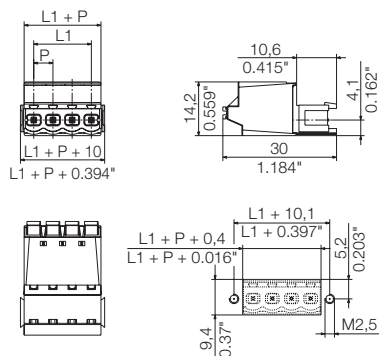

Ordering data

Solder pin length					
Colour		Orange			
Pitch 5.08 mm					
Pol.	L1	(inch)	Qty.	Order No.	
2	5.08	0.200	150	1335440000	
3	10.16	0.400	108	1335450000	
4	15.24	0.600	78	1335460000	
5	20.32	0.800	66	1335470000	
6	25.40	1.000	54	1335480000	
7	30.48	1.200	48	1335490000	
8	35.56	1.400	42	1335510000	
9	40.64	1.600	36	1335520000	
10	45.72	1.800	30	1335530000	
11	50.80	2.000	30	1335540000	
12	55.88	2.200	24	1335550000	

SLF 5.08/./180F



Dimensioned drawing

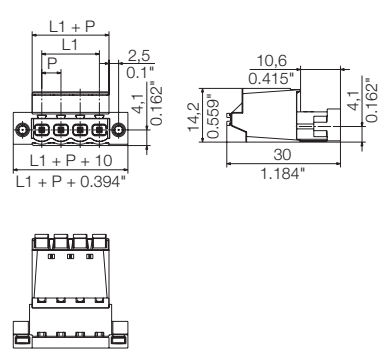

Ordering data

Solder pin length					
Colour		Orange			
Pitch 5.08 mm					
Pol.	L1	(inch)	Qty.	Order No.	
2	5.08	0.200	90	1335590000	
3	10.16	0.400	72	1335620000	
4	15.24	0.600	60	1335640000	
5	20.32	0.800	54	1335660000	
6	25.40	1.000	42	1335680000	
7	30.48	1.200	42	1335700000	
8	35.56	1.400	36	1335720000	
9	40.64	1.600	30	1335740000	
10	45.72	1.800	30	1335760000	
11	50.80	2.000	24	1335780000	
12	55.88	2.200	24	1335800000	

SLF 5.08/./180FI



Dimensioned drawing

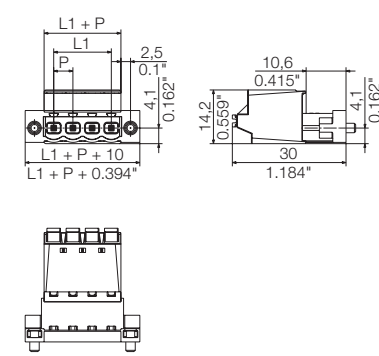

Ordering data

Solder pin length					
Colour		Orange			
Pitch 5.08 mm					
Pol.	L1	(inch)	Qty.	Order No.	
2	5.08	0.200	90	1336400000	
3	10.16	0.400	72	1336410000	
4	15.24	0.600	60	1336420000	
5	20.32	0.800	54	1336430000	
6	25.40	1.000	42	1336440000	
7	30.48	1.200	42	1336450000	
8	35.56	1.400	36	1336470000	
9	40.64	1.600	30	1336480000	
10	45.72	1.800	30	1336490000	
11	50.80	2.000	24	1336500000	
12	55.88	2.200	24	1336510000	

## Connectors in 5.08 mm pitch Series BL/SL 5.08

### BLZP 5.08HC../180



The BLZP is the functional extension of the BLZ series. The "P" in the part name stands for a plus in security and performance in processing and use.

- WIRE READY - delivered with terminal points already opened
- Power tools can be used with the globally compatible plus/minus screw head
- Folded steel clamping yoke accommodates the connected wire and compensates for temperature fluctuations
- The integrated wire guard prevents dangerous under-insertion of the wire from occurring.
- Lock and release-lever: tool-less locking and gentle releasing of the connector reduces the mechanical stress on the solder joints.

### Product data

IEC: 400 V / 23 A / 0.2 - 4 mm<sup>2</sup>  
UL: 300 V / 20 A / AWG 26 - 12



For additional articles and information, refer to [catalog.weidmueller.com](http://catalog.weidmueller.com)

#### Note:

- Additional colours on request
- Gold-plated contact surfaces on request
- Rated current related to rated cross-section & min. No. of poles.
- Wire end ferrule without plastic collar to DIN 46228/1
- Wire end ferrule with plastic collar to DIN 46228/4
- P on drawing = pitch
- Rated data refer only to the component itself. Clearance and creepage distances to other components are to be designed in accordance with the relevant application standards.

### BLZP 5.08HC../180



#### Dimensioned drawing

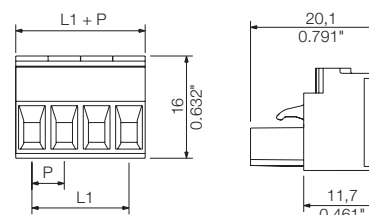

## G

### Technical data

In compliance with IEC 60664-1 / IEC 61984			
Clamping range, max.	mm <sup>2</sup>	0.13...4	
<b>Solid core H05(07) V-U</b>	<b>mm<sup>2</sup></b>	<b>0.2...4</b>	
Stranded H07 V-R			
Flexible H05(07) V-K	mm <sup>2</sup>	0.2...4	
Flexible with ferrule	mm <sup>2</sup>	0.2...4	
Ferrule with plastic collar	mm <sup>2</sup>	0.2...2.5	
Stripping length	mm	7	
Screwdriver blade	mm	0.6 x 3.5, PH 1	
According to norm			
Tightening torque range	Nm	0.4...0.5	
<b>Rated current, max.</b>	<b>A</b>	<b>23</b>	<b>21</b>
At ambient temperature		20°C	40°C
For conductor cross-section	mm <sup>2</sup>	4	
Overvoltage category		III	III II
Pollution severity		3	2 2
<b>Rated voltage</b>	<b>V</b>	<b>250</b>	<b>320 400</b>
Rated impulse voltage	kV	4	4 4
<b>UL / CUL (Use Group)</b>	<b>B C D</b>		
<b>Rated voltage</b>	<b>V</b>	<b>300</b>	<b>300</b>
<b>Rated current</b>	<b>A</b>	<b>20</b>	<b>10</b>
<b>AWG conductor</b>	<b>AWG</b>	<b>26-12</b>	
<b>CSA (Use Group)</b>	<b>B C D</b>		
Rated voltage	V	300	50 300
Rated current	A	20	20
AWG conductor	AWG	30-12	
<b>General data</b>			
Type of insulation material		PBT	
UL 94 flammability rating		V-0	
Contact base material		Copper alloy	
Material of contact surface		tinned	
Pin dimensions = d	mm		
Solder eyelet Ø = D	mm		
Solder eyelet Ø tolerance	mm		

5.08

180°



4 mm<sup>2</sup>

### Accessories

Note: Refer to the Accessories chapter for additional accessories.

Strain relief		Order No.
	BLZ 5.08 ZE04 OR BX	1652110000
	BLZ 5.08 ZE04 BK BX	1652130000
	BLZ 5.08 ZE08 OR BX	1652050000
	BLZ 5.08 ZE08 BK BX	1652070000
Coding		
	BLZ/SL KO QR BX	1573010000
	BLZ/SL KO BK BX	1545710000
Screwdriver		
	SDS 0.6X3.5X100	9008330000
	SDIS 0.6X3.5X100	9008390000
	SDK PZ1	9008530000
Crosshead screwdriver		
	SDK PH1	9008480000

### Ordering data

Solder pin length				
Colour	Orange			
Pitch	5.08 mm			
Pol.	L1	(inch)	Qty.	Order No.
2	5.08	0.200	180	1943580000
3	10.16	0.400	120	1943590000
4	15.24	0.600	90	1943600000
5	20.32	0.800	72	1943610000
6	25.40	1.000	60	1943620000
7	30.48	1.200	48	1943630000
8	35.56	1.400	42	1943640000
9	40.64	1.600	36	1943650000
10	45.72	1.800	36	1943660000
11	50.80	2.000	30	1943670000
12	55.88	2.200	30	1943680000
13	60.96	2.400	24	1943690000
14	66.04	2.600	24	1943700000
15	71.12	2.800	24	1943710000
16	76.20	3.000	18	1943720000
17	81.28	3.200	18	1943730000
18	86.36	3.400	18	1943740000
19	91.44	3.600	18	1943750000
20	96.52	3.800	18	1943760000
21	101.60	4.000	12	1943770000
22	106.68	4.200	12	1943780000
23	111.76	4.400	12	1943790000
24	116.84	4.600	12	1943800000

### Representative deratings curve

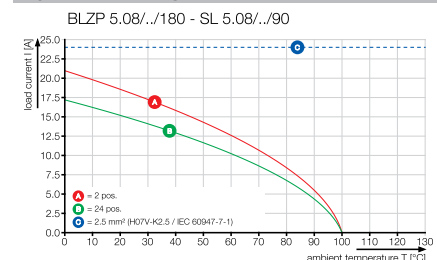

BLZP 5.08HC../180F



Dimensioned drawing

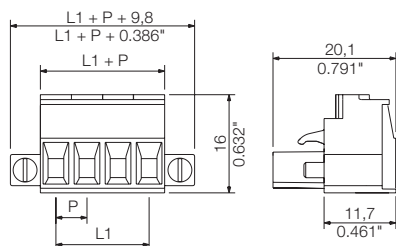

Ordering data

Solder pin length					
Colour					Orange
Pitch	5.08 mm				
Pol.	L1	(inch)	Qty.	Order No.	
2	5.08	0.200	90	1944090000	
3	10.16	0.400	72	1944100000	
4	15.24	0.600	60	1944110000	
5	20.32	0.800	48	1944120000	
6	25.40	1.000	42	1944130000	
7	30.48	1.200	36	1944140000	
8	35.56	1.400	36	1944150000	
9	40.64	1.600	30	1944160000	
10	45.72	1.800	30	1944170000	
11	50.80	2.000	24	1944180000	
12	55.88	2.200	24	1944190000	
13	60.96	2.400	24	1944200000	
14	66.04	2.600	18	1944210000	
15	71.12	2.800	18	1944220000	
16	76.20	3.000	18	1944230000	
17	81.28	3.200	18	1944240000	
18	86.36	3.400	18	1944250000	
19	91.44	3.600	12	1944260000	
20	96.52	3.800	12	1944270000	
21	101.60	4.000	12	1944280000	
22	106.68	4.200	12	1944290000	
23	111.76	4.400	12	1944300000	
24	116.84	4.600	12	1944310000	

BLZP 5.08HC../180LR

with release latch



Dimensioned drawing

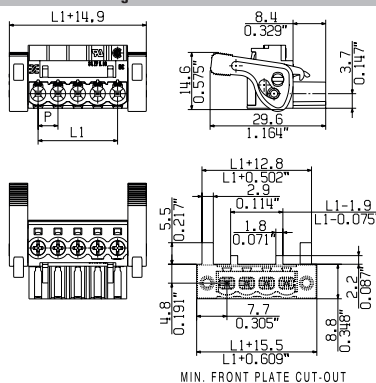

Ordering data

Solder pin length					
Colour					Orange
Pitch	5.08 mm				
Pol.	L1	(inch)	Qty.	Order No.	
2	5.08	0.200	90	1944830000	
3	10.16	0.400	72	1944840000	
4	15.24	0.600	60	1944850000	
5	20.32	0.800	48	1944860000	
6	25.40	1.000	42	1944870000	
7	30.48	1.200	36	1944880000	
8	35.56	1.400	36	1944890000	
9	40.64	1.600	30	1944900000	
10	45.72	1.800	30	1944910000	
11	50.80	2.000	24	1944920000	
12	55.88	2.200	24	1944930000	
13	60.96	2.400	24	1944940000	
14	66.04	2.600	18	1944950000	
15	71.12	2.800	18	1944960000	
16	76.20	3.000	18	1944970000	
17	81.28	3.200	18	1944980000	
18	86.36	3.400	18	1944990000	
19	91.44	3.600	12	1945000000	
20	96.52	3.800	12	1945010000	
21	101.60	4.000	12	1945020000	
22	106.68	4.200	12	1945030000	
23	111.76	4.400	12	1945040000	
24	116.84	4.600	12	1945050000	

The 2-in-1 contact

Every pluggable connector covers two contact points and thus must meet two different requirements: First, the wire termination and second, the connection between plug and pin header. Referring to the 5.0x pitch series, Weidmüller offers different wire connection technologies, but one platform contact for the male / female connection since years. This well-designed hybride platform contact ensures a constant quality on a very high level. Hybride means, that we combine metal material featuring different characteristics by welding, in order to devide the contact system into different function zones: Further to the high electric conductance, the current bar is characterized by its hardness, and the tulip contact by its excellent tension properties. The advantage: each function is supported by the most suitable material to reliably and constantly meet the different electrical and mechanical requirements. To put it in a nutshell: Instead of either ... or, it's even both - perfect for the current, and perfect for the force.



Additional deratings curves

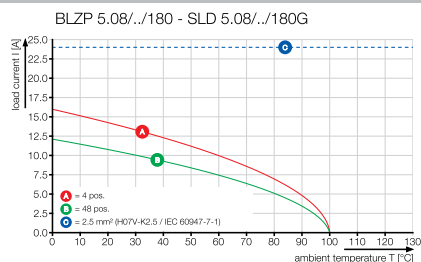
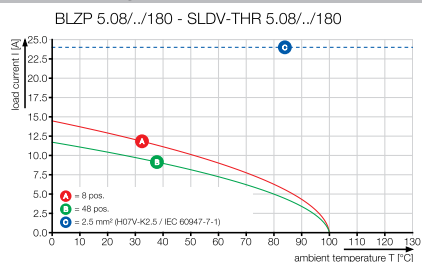

## Connectors in 5.08 mm pitch Series BL/SL 5.08

### BLZP 5.08HC../90

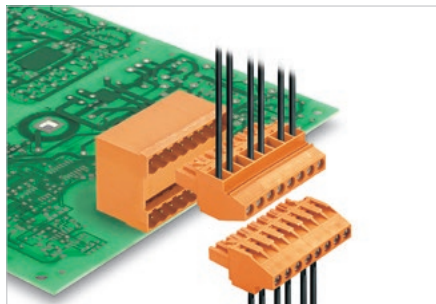

The BLZP is the functional extension of the BLZ series. The "P" in the part name stands for a plus in security and performance in processing and use.

- WIRE READY - delivered with terminal points already opened
- Power tools can be used with the globally compatible plus/minus screw head
- Folded steel clamping yoke accommodates the connected wire and compensates for temperature fluctuations
- The integrated wire guard prevents dangerous under-insertion of the wire from occurring.
- Lock and release-lever: tool-less locking and gentle releasing of the connector reduces the mechanical stress on the solder joints.

### Product data

IEC: 400 V / 23 A / 0.2 - 4 mm<sup>2</sup>  
UL: 300 V / 20 A / AWG 26 - 12



For additional articles and information, refer to [catalog.weidmueller.com](http://catalog.weidmueller.com)

#### Note:

- Additional colours on request
- Gold-plated contact surfaces on request
- Rated current related to rated cross-section & min. No. of poles.
- Wire end ferrule without plastic collar to DIN 46228/1
- Wire end ferrule with plastic collar to DIN 46228/4
- P on drawing = pitch
- Rated data refer only to the component itself. Clearance and creepage distances to other components are to be designed in accordance with the relevant application standards.

### BLZP 5.08HC../90



#### Dimensioned drawing

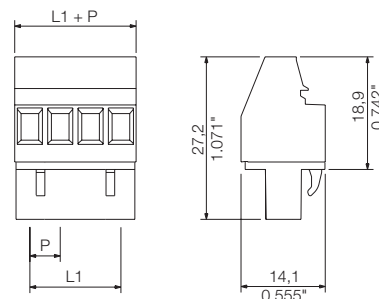

### Technical data

#### In compliance with IEC 60664-1 / IEC 61984

Clamping range, max.	mm <sup>2</sup>	0.13...4
<b>Solid core H05(07) V-U</b>	<b>mm<sup>2</sup></b>	<b>0.2...4</b>
Stranded H07 V-R		
Flexible H05(07) V-K	mm <sup>2</sup>	0.2...4
Flexible with ferrule	mm <sup>2</sup>	0.2...4
Ferrule with plastic collar	mm <sup>2</sup>	0.2...2.5
Stripping length	mm	7
Screwdriver blade	mm	

According to norm

Tightening torque range	Nm	0.4...0.5
<b>Rated current, max.</b>	<b>A</b>	<b>23 21</b>
At ambient temperature	20°C 40°C	

For conductor cross-section	mm <sup>2</sup>	4
Overvoltage category		III III II
Pollution severity		3 2 2

<b>Rated voltage</b>	<b>V</b>	<b>250 320 400</b>
Rated impulse voltage	kV	4 4 4

<b>UL / CUL (Use Group)</b>	<b>B C D</b>	
-----------------------------	--------------	--

<b>Rated voltage</b>	<b>V</b>	<b>300 300</b>
<b>Rated current</b>	<b>A</b>	<b>20 10</b>

<b>AWG conductor</b>	<b>AWG</b>	<b>26-12</b>
----------------------	------------	--------------

<b>CSA (Use Group)</b>	<b>B C D</b>	
------------------------	--------------	--

Rated voltage	V	300 50 300
Rated current	A	20 20
AWG conductor	AWG	30-12

#### General data

Type of insulation material	PBT
UL 94 flammability rating	V-0
Contact base material	Copper alloy
Material of contact surface	tinned
Pin dimensions = d	mm
Solder eyelet Ø = D	mm
Solder eyelet Ø tolerance	mm

### Accessories

Note: Refer to the Accessories chapter for additional accessories.

Coding	Order No.
BLZ/SL KO OR BX	<b>1573010000</b>
BLZ/SL KO BK BX	<b>1545710000</b>
Screwdriver	
SDS 0.6X3.5X100	<b>9008330000</b>
SDIS 0.6X3.5X100	<b>9008390000</b>
SDK PZ1	<b>9008530000</b>
Crosshead screwdriver	
SDK PH1	<b>9008480000</b>

### Ordering data

Solder pin length				
Colour	Orange			
Pitch	5.08 mm			
Pol.	L1	(inch)	Qty.	Order No.
2	5.08	0.200	180	<b>1948000000</b>
3	10.16	0.400	120	<b>1948010000</b>
4	15.24	0.600	90	<b>1948020000</b>
5	20.32	0.800	72	<b>1948030000</b>
6	25.40	1.000	60	<b>1948040000</b>
7	30.48	1.200	48	<b>1948050000</b>
8	35.56	1.400	42	<b>1948060000</b>
9	40.64	1.600	36	<b>1948070000</b>
10	45.72	1.800	36	<b>1948080000</b>
11	50.80	2.000	30	<b>1948100000</b>
12	55.88	2.200	30	<b>1948110000</b>
13	60.96	2.400	24	<b>1948120000</b>
14	66.04	2.600	24	<b>1948130000</b>
15	71.12	2.800	24	<b>1948140000</b>
16	76.20	3.000	18	<b>1948150000</b>
17	81.28	3.200	18	<b>1948160000</b>
18	86.36	3.400	18	<b>1948170000</b>
19	91.44	3.600	18	<b>1948180000</b>
20	96.52	3.800	18	<b>1948190000</b>
21	101.60	4.000	12	<b>1948200000</b>
22	106.68	4.200	12	<b>1948210000</b>
23	111.76	4.400	12	<b>1948220000</b>
24	116.84	4.600	12	<b>1948230000</b>

### Representative deratings curve

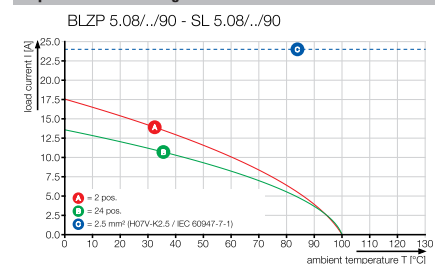



**BLZP 5.08HC../90F**



Dimensioned drawing

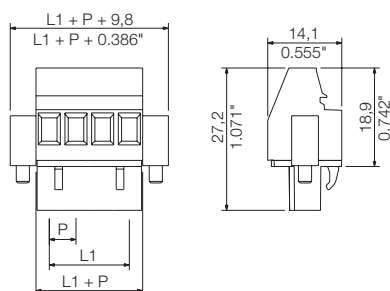

**Ordering data**

Solder pin length					
Colour					Orange
Pitch 5.08 mm					
Pol.	L1	(inch)	Qty.	Order No.	
2	5.08	0.200	90	1949800000	
3	10.16	0.400	72	1949810000	
4	15.24	0.600	60	1949820000	
5	20.32	0.800	48	1949830000	
6	25.40	1.000	42	1949840000	
7	30.48	1.200	36	1949850000	
8	35.56	1.400	36	1949860000	
9	40.64	1.600	30	1949870000	
10	45.72	1.800	30	1949880000	
11	50.80	2.000	24	1949890000	
12	55.88	2.200	24	1949900000	
13	60.96	2.400	24	1949910000	
14	66.04	2.600	18	1949920000	
15	71.12	2.800	18	1949930000	
16	76.20	3.000	18	1949940000	
17	81.28	3.200	18	1949950000	
18	86.36	3.400	18	1949960000	
19	91.44	3.600	12	1949970000	
20	96.52	3.800	12	1949980000	
21	101.60	4.000	12	1949990000	
22	106.68	4.200	12	1950010000	
23	111.76	4.400	12	1950020000	
24	116.84	4.600	12	1950030000	

**BLZP 5.08HC../90LR**

with release latch



Dimensioned drawing

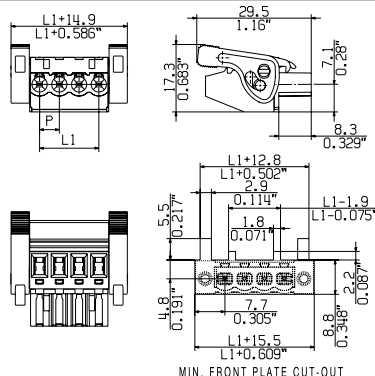

**Ordering data**

Solder pin length					
Colour					Orange
Pitch 5.08 mm					
Pol.	L1	(inch)	Qty.	Order No.	
2	5.08	0.200	90	1087250000	
3	10.16	0.400	72	1087260000	
4	15.24	0.600	60	1087270000	
5	20.32	0.800	48	1087280000	
6	25.40	1.000	42	1087290000	
7	30.48	1.200	36	1087300000	
8	35.56	1.400	36	1087310000	
9	40.64	1.600	30	1087320000	
10	45.72	1.800	30	1087330000	
11	50.80	2.000	24	1087340000	
12	55.88	2.200	24	1087350000	
13	60.96	2.400	24	1087360000	
14	66.04	2.600	18	1087370000	
15	71.12	2.800	18	1087380000	
16	76.20	3.000	18	1087390000	
17	81.28	3.200	18	1087400000	
18	86.36	3.400	18	1087410000	
19	91.44	3.600	12	1087420000	
20	96.52	3.800	12	1087430000	
21	101.60	4.000	12	1087440000	
22	106.68	4.200	12	1087450000	
23	111.76	4.400	12	1087460000	
24	116.84	4.600	12	1087470000	

**The 2-in-1 contact**

Every pluggable connector covers two contact points and thus must meet two different requirements: First, the wire termination and second, the connection between plug and pin header. Referring to the 5.0x pitch series, Weidmüller offers different wire connection technologies, but one platform contact for the male / female connection since years. This well-designed hybride platform contact ensures a constant quality on a very high level. Hybride means, that we combine metal material featuring different characteristics by welding, in order to devide the contact system into different function zones: Further to the high electric conductance, the current bar is characterized by its hardness, and the tulip contact by its excellent tension properties. The advantage: each function is supported by the most suitable material to reliably and constantly meet the different electrical and mechanical requirements. To put it in a nutshell: Instead of either ... or, it's even both - perfect for the current, and perfect for the force.



## Connectors in 5.08 mm pitch Series BL/SL 5.08

### BLZP 5.08HC../270

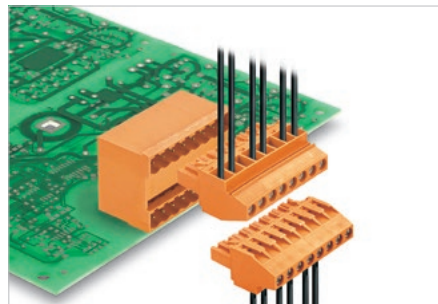

The BLZP is the functional extension of the BLZ series. The "P" in the part name stands for a plus in security and performance in processing and use.

- WIRE READY - delivered with terminal points already opened
- Power tools can be used with the globally compatible plus/minus screw head
- Folded steel clamping yoke accommodates the connected wire and compensates for temperature fluctuations
- The integrated wire guard prevents dangerous under-insertion of the wire from occurring.
- Lock and release-lever: tool-less locking and gentle releasing of the connector reduces the mechanical stress on the solder joints.

### Product data

IEC: 400 V / 23 A / 0.2 - 4 mm<sup>2</sup>  
UL: 300 V / 20 A / AWG 26 - 12



For additional articles and information, refer to [catalog.weidmuller.com](http://catalog.weidmuller.com)

#### Note:

- Additional colours on request
- Gold-plated contact surfaces on request
- Rated current related to rated cross-section & min. No. of poles.
- Wire end ferrule without plastic collar to DIN 46228/1
- Wire end ferrule with plastic collar to DIN 46228/4
- P on drawing = pitch
- Rated data refer only to the component itself. Clearance and creepage distances to other components are to be designed in accordance with the relevant application standards.

### BLZP 5.08HC../270



#### Dimensioned drawing

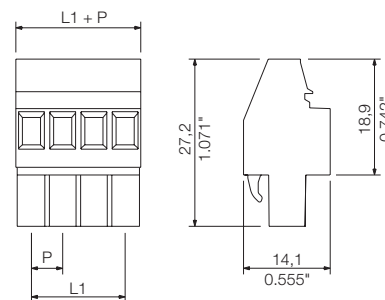

### Technical data

#### In compliance with IEC 60664-1 / IEC 61984

Clamping range, max.	mm <sup>2</sup>	0.13...4
<b>Solid core H05(07) V-U</b>	<b>mm<sup>2</sup></b>	<b>0.2...4</b>
Stranded H07 V-R		
Flexible H05(07) V-K	mm <sup>2</sup>	0.2...4
Flexible with ferrule	mm <sup>2</sup>	0.2...4
Ferrule with plastic collar	mm <sup>2</sup>	0.2...2.5
Stripping length	mm	7
Screwdriver blade	mm	

According to norm

Tightening torque range	Nm	0.4...0.5
<b>Rated current, max.</b>	<b>A</b>	<b>23 21</b>
At ambient temperature	20°C 40°C	
For conductor cross-section	mm <sup>2</sup>	4
Overvoltage category		III III II
Pollution severity		3 2 2
<b>Rated voltage</b>	<b>V</b>	<b>250 320 400</b>
Rated impulse voltage	kV	4 4 4

#### UL / CUL (Use Group)

<b>Rated voltage</b>	<b>V</b>	<b>300 300</b>
<b>Rated current</b>	<b>A</b>	<b>20 10</b>
<b>AWG conductor</b>	<b>AWG</b>	<b>26-12</b>
<b>CSA (Use Group)</b>	<b>B C D</b>	
Rated voltage	V	300 50 300
Rated current	A	20 20
AWG conductor	AWG	30-12

#### General data

Type of insulation material	PBT
UL 94 flammability rating	V-0
Contact base material	Copper alloy
Material of contact surface	tinned
Pin dimensions = d	mm
Solder eyelet Ø = D	mm
Solder eyelet Ø tolerance	mm

5.08

270°

4 mm<sup>2</sup>

### Accessories

Note: Refer to the Accessories chapter for additional accessories.

Coding	Order No.
BLZ/SL KO OR BX	<b>1573010000</b>
BLZ/SL KO BK BX	<b>1545710000</b>
Screwdriver	
SDS 0.6X3.5X100	<b>9008330000</b>
SDIS 0.6X3.5X100	<b>9008390000</b>
SDK PZ1	<b>9008530000</b>
Crosshead screwdriver	
SDK PH1	<b>9008480000</b>

### Ordering data

Solder pin length				
Colour	Orange			
Pitch	5.08 mm			
Pol.	L1	(inch)	Qty.	Order No.
2	5.08	0.200	180	<b>1948790000</b>
3	10.16	0.400	120	<b>1948800000</b>
4	15.24	0.600	90	<b>1948810000</b>
5	20.32	0.800	72	<b>1948820000</b>
6	25.40	1.000	60	<b>1948830000</b>
7	30.48	1.200	48	<b>1948840000</b>
8	35.56	1.400	42	<b>1948850000</b>
9	40.64	1.600	36	<b>1948860000</b>
10	45.72	1.800	36	<b>1948870000</b>
11	50.80	2.000	30	<b>1948880000</b>
12	55.88	2.200	30	<b>1948890000</b>
13	60.96	2.400	24	<b>1948900000</b>
14	66.04	2.600	24	<b>1948910000</b>
15	71.12	2.800	24	<b>1948920000</b>
16	76.20	3.000	18	<b>1948930000</b>
17	81.28	3.200	18	<b>1948940000</b>
18	86.36	3.400	18	<b>1948950000</b>
19	91.44	3.600	18	<b>1948960000</b>
20	96.52	3.800	18	<b>1948970000</b>
21	101.60	4.000	12	<b>1948980000</b>
22	106.68	4.200	12	<b>1948990000</b>
23	111.76	4.400	12	<b>1949000000</b>
24	116.84	4.600	12	<b>1949010000</b>

### Representative deratings curve

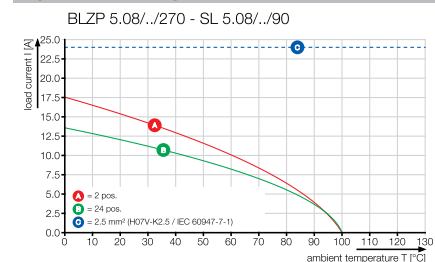

**BLZP 5.08HC../270F**



Dimensioned drawing

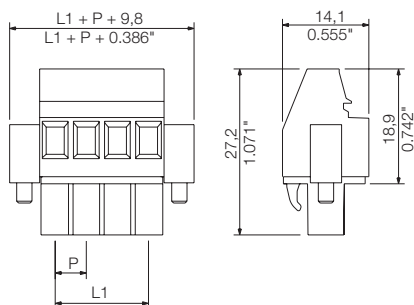

**Ordering data**

Solder pin length					
Colour					Orange
Pitch	5.08 mm				
Pol.	L1	(inch)	Qty.	Order No.	
2	5.08	0.200	90	1950310000	
3	10.16	0.400	72	1950320000	
4	15.24	0.600	60	1950330000	
5	20.32	0.800	48	1950340000	
6	25.40	1.000	42	1950350000	
7	30.48	1.200	36	1950360000	
8	35.56	1.400	36	1950370000	
9	40.64	1.600	30	1950380000	
10	45.72	1.800	30	1950390000	
11	50.80	2.000	24	1950400000	
12	55.88	2.200	24	1950410000	
13	60.96	2.400	24	1950420000	
14	66.04	2.600	18	1950430000	
15	71.12	2.800	18	1950440000	
16	76.20	3.000	18	1950450000	
17	81.28	3.200	18	1950460000	
18	86.36	3.400	18	1950470000	
19	91.44	3.600	12	1950480000	
20	96.52	3.800	12	1950490000	
21	101.60	4.000	12	1950500000	
22	106.68	4.200	12	1950510000	
23	111.76	4.400	12	1950520000	
24	116.84	4.600	12	1950540000	

**BLZP 5.08HC../270LR**

with release latch



Dimensioned drawing

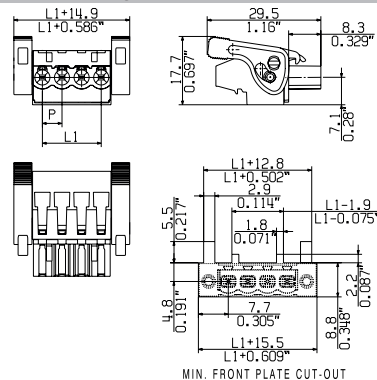

**Ordering data**

Solder pin length					
Colour					Orange
Pitch	5.08 mm				
Pol.	L1	(inch)	Qty.	Order No.	
2	5.08	0.200	90	1947530000	
3	10.16	0.400	72	1947540000	
4	15.24	0.600	60	1947550000	
5	20.32	0.800	48	1947560000	
6	25.40	1.000	42	1947570000	
7	30.48	1.200	36	1947580000	
8	35.56	1.400	36	1947590000	
9	40.64	1.600	30	1947600000	
10	45.72	1.800	30	1947610000	
11	50.80	2.000	24	1947620000	
12	55.88	2.200	24	1947630000	
13	60.96	2.400	24	1947640000	
14	66.04	2.600	18	1947650000	
15	71.12	2.800	18	1947660000	
16	76.20	3.000	18	1947670000	
17	81.28	3.200	18	1947680000	
18	86.36	3.400	18	1947690000	
19	91.44	3.600	12	1947700000	
20	96.52	3.800	12	1947710000	
21	101.60	4.000	12	1947720000	
22	106.68	4.200	12	1947730000	
23	111.76	4.400	12	1947740000	
24	116.84	4.600	12	1947750000	

**The 2-in-1 contact**

Every pluggable connector covers two contact points and thus must meet two different requirements: First, the wire termination and second, the connection between plug and pin header. Referring to the 5.0x pitch series, Weidmüller offers different wire connection technologies, but one platform contact for the male / female connection since years. This well-designed hybride platform contact ensures a constant quality on a very high level. Hybride means, that we combine metal material featuring different characteristics by welding, in order to devide the contact system into different function zones: Further to the high electric conductance, the current bar is characterized by its hardness, and the tulip contact by its excellent tension properties. The advantage: each function is supported by the most suitable material to reliably and constantly meet the different electrical and mechanical requirements. To put it in a nutshell: Instead of either ... or, it's even both - perfect for the current, and perfect for the force.



## Connectors in 5.08 mm pitch Series BL/SL 5.08

### BLZP 5.08HC../225

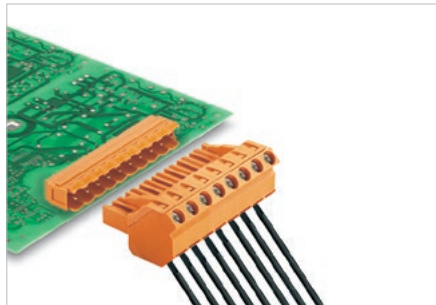

The BLZP is the functional extension of the BLZ series. The "P" in the part name stands for a plus in security and performance in processing and use.

- WIRE READY - delivered with terminal points already opened
- Power tools can be used with the globally compatible plus/minus screw head
- Folded steel clamping yoke accommodates the connected wire and compensates for temperature fluctuations
- The integrated wire guard prevents dangerous under-insertion of the wire from occurring.
- Lock and release-lever: tool-less locking and gentle releasing of the connector reduces the mechanical stress on the solder joints.

### Product data

IEC: 400 V / 17.5 A / 0.2 - 4 mm<sup>2</sup>  
UL: 300 V / 15 A / AWG 26 - 12



For additional articles and information, refer to [catalog.weidmueller.com](http://catalog.weidmueller.com)

#### Note:

- Additional colours on request
- Gold-plated contact surfaces on request
- Rated current related to rated cross-section & min. No. of poles.
- Wire end ferrule without plastic collar to DIN 46228/1
- Wire end ferrule with plastic collar to DIN 46228/4
- P on drawing = pitch
- Rated data refer only to the component itself. Clearance and creepage distances to other components are to be designed in accordance with the relevant application standards.

### BLZP 5.08HC../225



#### Dimensioned drawing

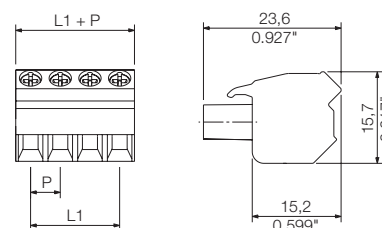

### Technical data

In compliance with IEC 60664-1 / IEC 61984			
Clamping range, max.	mm <sup>2</sup>	0.13...4	
<b>Solid core H05(07) V-U</b>	mm <sup>2</sup>	<b>0.2...4</b>	
Stranded H07 V-R			
Flexible H05(07) V-K	mm <sup>2</sup>	0.2...4	
Flexible with ferrule	mm <sup>2</sup>	0.2...4	
Ferrule with plastic collar	mm <sup>2</sup>	0.2...2.5	
Stripping length	mm	7	
Screwdriver blade	mm		
According to norm			
Tightening torque range	Nm	0.4...0.5	
<b>Rated current, max.</b>	<b>A</b>	<b>17.5</b>	<b>14</b>
At ambient temperature		20°C	40°C
For conductor cross-section	mm <sup>2</sup>	4	
Overvoltage category		III	III II
Pollution severity		3	2 2
<b>Rated voltage</b>	<b>V</b>	<b>250</b>	<b>320 400</b>
Rated impulse voltage	kV	4	4 4
<b>UL / CUL (Use Group)</b>		<b>B</b>	<b>C D</b>
<b>Rated voltage</b>	<b>V</b>	<b>300</b>	<b>300</b>
<b>Rated current</b>	<b>A</b>	<b>15</b>	<b>10</b>
<b>AWG conductor</b>	<b>AWG</b>	<b>26-12</b>	
<b>CSA (Use Group)</b>		<b>B</b>	<b>C D</b>
Rated voltage	V	300	50 300
Rated current	A	15	15
AWG conductor	AWG	30-12	
General data			
Type of insulation material		PBT	
UL 94 flammability rating		V-0	
Contact base material		Copper alloy	
Material of contact surface		tinned	
Pin dimensions = d	mm		
Solder eyelet Ø = D			
Solder eyelet Ø tolerance	mm		

### Accessories

Note: Refer to the Accessories chapter for additional accessories.

Coding	Order No.
BLZ/SL KO OR BX	<b>1573010000</b>
BLZ/SL KO BK BX	<b>1545710000</b>
Screwdriver	
SDS 0.6X3.5X100	<b>9008330000</b>
SDIS 0.6X3.5X100	<b>9008390000</b>
SDK PZ1	<b>9008530000</b>
Crosshead screwdriver	
SDK PH1	<b>9008480000</b>

### Ordering data

Solder pin length				
Colour	Orange			
Pitch	5.08 mm			
Pol.	L1	(inch)	Qty.	Order No.
2	5.08	0.200	180	<b>1946250000</b>
3	10.16	0.400	120	<b>1946260000</b>
4	15.24	0.600	90	<b>1946270000</b>
5	20.32	0.800	72	<b>1946280000</b>
6	25.40	1.000	60	<b>1946290000</b>
7	30.48	1.200	48	<b>1946300000</b>
8	35.56	1.400	42	<b>1946310000</b>
9	40.64	1.600	36	<b>1946320000</b>
10	45.72	1.800	36	<b>1946330000</b>
11	50.80	2.000	30	<b>1946340000</b>
12	55.88	2.200	30	<b>1946350000</b>
13	60.96	2.400	24	<b>1946360000</b>
14	66.04	2.600	24	<b>1946370000</b>
15	71.12	2.800	24	<b>1946380000</b>
16	76.20	3.000	18	<b>1946390000</b>
17	81.28	3.200	18	<b>1946400000</b>
18	86.36	3.400	18	<b>1946410000</b>
19	91.44	3.600	18	<b>1946420000</b>
20	96.52	3.800	18	<b>1946430000</b>
21	101.60	4.000	12	<b>1946440000</b>
22	106.68	4.200	12	<b>1946450000</b>
23	111.76	4.400	12	<b>1946460000</b>
24	116.84	4.600	12	<b>1946480000</b>

### Representative deratings curve

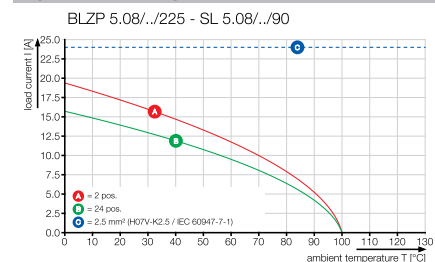

5.08

225°



4 mm<sup>2</sup>

BLZP 5.08HC../225B



Dimensioned drawing

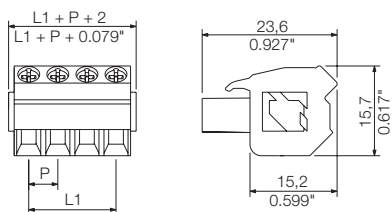

The 2-in-1 contact

Every pluggable connector covers two contact points and thus must meet two different requirements: First, the wire termination and second, the connection between plug and pin header. Referring to the 5.0x pitch series, Weidmüller offers different wire connection technologies, but one platform contact for the male / female connection since years. This well-designed hybride platform contact ensures a constant quality on a very high level. Hybride means, that we combine metal material featuring different characteristics by welding, in order to devide the contact system into different function zones: Further to the high electric conductance, the current bar is characterized by its hardness, and the tulip contact by its excellent tension properties. The advantage: each function is supported by the most suitable material to reliably and constantly meet the different electrical and mechanical requirements. To put it in a nutshell: Instead of either ... or, it 's even both - perfect for the current, and perfect for the force.



Ordering data

Solder pin length				
Colour				Orange
Pitch		5.08 mm		
Pol.	L1	(inch)	Qty.	Order No.
2	5.08	0.200	150	1945750000
3	10.16	0.400	108	1945760000
4	15.24	0.600	78	1945770000
5	20.32	0.800	66	1945780000
6	25.40	1.000	54	1945790000
7	30.48	1.200	48	1945800000
8	35.56	1.400	42	1945810000
9	40.64	1.600	36	1945820000
10	45.72	1.800	30	1945830000
11	50.80	2.000	30	1945840000
12	55.88	2.200	24	1945850000
13	60.96	2.400	24	1945860000
14	66.04	2.600	24	1945870000
15	71.12	2.800	24	1945880000
16	76.20	3.000	18	1945890000
17	81.28	3.200	18	1945900000
18	86.36	3.400	18	1945910000
19	91.44	3.600	18	1945920000
20	96.52	3.800	18	1945930000
21	101.60	4.000	12	1945940000
22	106.68	4.200	12	1945950000
23	111.76	4.400	12	1945960000
24	116.84	4.600	12	1945970000

## Connectors in 5.08 mm pitch Series BL/SL 5.08

### BLT 5.08HC/./180

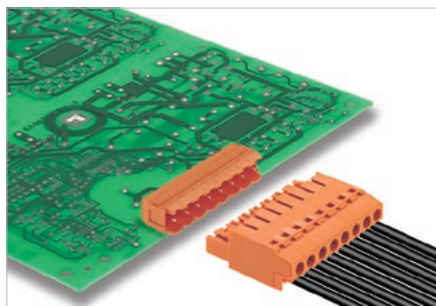

The BLT is currently the most compact TOP connection of its type available in 5.08 mm pitch.

- The BLT's "pull effect" ensures that the connected wire is pulled in to the clamping point.
- The extra flat shape allows for dense component assembly.
- The specialist for cramped installations
- The screw connect and the cable entry are located on the same side of the connector.
- Lock and release-lever: tool-less locking and gentle releasing of the connector reduces the mechanical stress on the solder joints.

### Product data

IEC: 400 V / 27 A / 0.2 - 2.5 mm<sup>2</sup>  
UL: 300 V / 17 A / AWG 26 - 14



For additional articles and information, refer to [catalog.weidmuller.com](http://catalog.weidmuller.com)

#### Note:

- Additional colours on request
- Gold-plated contact surfaces on request
- Rated current related to rated cross-section & min. No. of poles.
- Wire end ferrule without plastic collar to DIN 46228/1
- Wire end ferrule with plastic collar to DIN 46228/4
- Crimp form A for wire end ferrules with PZ 6/5 crimping tool are recommended for the largest cable sizes.
- P on drawing = pitch
- Rated data refer only to the component itself. Clearance and creepage distances to other components are to be designed in accordance with the relevant application standards.

### BLT 5.08HC/./180



#### Dimensioned drawing

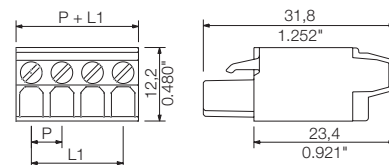

## G

### Technical data

In compliance with IEC 60664-1 / IEC 61984			
Clamping range, max.	mm <sup>2</sup>	0.13...2.5	
<b>Solid core H05(07) V-U</b>	<b>mm<sup>2</sup></b>	<b>0.2...2.5</b>	
Stranded H07 V-R			
Flexible H05(07) V-K	mm <sup>2</sup>	0.2...1.5	
Flexible with ferrule	mm <sup>2</sup>	0.2...1.5	
Ferrule with plastic collar	mm <sup>2</sup>	0.2...1.5	
Stripping length	mm	13	
Screwdriver blade	mm	0.6 x 3.5	
		According to norm	
Tightening torque range	Nm	0.4...0.5	
<b>Rated current, max.</b>	<b>A</b>	<b>27</b>	<b>24</b>
At ambient temperature		20°C	40°C
For conductor cross-section	mm <sup>2</sup>	2.5	
Overvoltage category		III	III II
Pollution severity		3	2 2
<b>Rated voltage</b>	<b>V</b>	<b>250</b>	<b>320 400</b>
Rated impulse voltage	kV	4	4 4
<b>UL / CUL (Use Group)</b>		<b>B</b>	<b>C D</b>
<b>Rated voltage</b>	<b>V</b>	<b>300</b>	<b>300</b>
<b>Rated current</b>	<b>A</b>	<b>17</b>	<b>10</b>
<b>AWG conductor</b>	<b>AWG</b>	<b>26-14</b>	
<b>CSA (Use Group)</b>		<b>B</b>	<b>C D</b>
Rated voltage	V	300	300
Rated current	A	15	15
AWG conductor	AWG	26-14	
<b>General data</b>			
Type of insulation material		PBT	
UL 94 flammability rating		V-0	
Contact base material		CuSn	
Material of contact surface		tinned	
Pin dimensions = d	mm		
Solder eyelet Ø = D	mm		
Solder eyelet Ø tolerance	mm		

### Accessories

Note: Refer to the Accessories chapter for additional accessories.

Strain relief		Order No.
	BLAT ZE04 OR BX	1577980000
	BLAT ZE08 OR BX	1578010000
<b>Coding</b>		
	BLZ/SL KO OR BX	1573010000
	BLZ/SL KO BK BX	1545710000
<b>Screwdriver</b>		
	SDS 0.6X3.5X100	9008330000
	SDIS 0.6X3.5X100	9008390000

### Ordering data

Solder pin length				
Colour	Orange			
Pitch	5.08 mm			
Pol.	L1	(inch)	Qty.	Order No.
2	5.08	0.200	180	1499560000
3	10.16	0.400	120	1499660000
4	15.24	0.600	90	1499760000
5	20.32	0.800	72	1499860000
6	25.40	1.000	60	1499960000
7	30.48	1.200	48	1500060000
8	35.56	1.400	42	1500160000
9	40.64	1.600	36	1500260000
10	45.72	1.800	36	1500360000
11	50.80	2.000	30	1500460000
12	55.88	2.200	30	1500560000
13	60.96	2.400	24	1500660000
14	66.04	2.600	24	1500760000
15	71.12	2.800	24	1500860000
16	76.20	3.000	18	1500960000
17	81.28	3.200	18	1501060000
18	86.36	3.400	18	1501160000
19	91.44	3.600	18	1501260000
20	96.52	3.800	18	1501360000
21	101.60	4.000	12	1501460000
22	106.68	4.200	12	1501560000
23	111.76	4.400	12	1501660000
24	116.84	4.600	12	1501760000

### Representative deratings curve

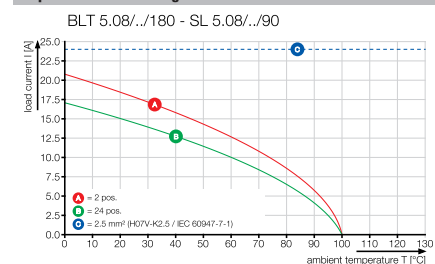

**BLT 5.08HC../180F**



Dimensioned drawing

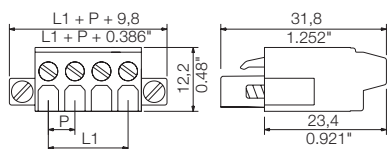

**Ordering data**

Solder pin length					
Colour					Orange
Pitch 5.08 mm					
Pol.	L1	(inch)	Qty.	Order No.	
2	5.08	0.200	90	1843990000	
3	10.16	0.400	72	1844000000	
4	15.24	0.600	60	1844010000	
5	20.32	0.800	48	1844020000	
6	25.40	1.000	42	1844030000	
7	30.48	1.200	36	1844040000	
8	35.56	1.400	36	1844050000	
9	40.64	1.600	30	1844060000	
10	45.72	1.800	30	1844070000	
11	50.80	2.000	24	1844080000	
12	55.88	2.200	24	1844090000	
13	60.96	2.400	24	1844100000	
14	66.04	2.600	18	1844110000	
15	71.12	2.800	18	1844120000	
16	76.20	3.000	18	1844130000	
17	81.28	3.200	18	1844140000	
18	86.36	3.400	18	1844150000	
19	91.44	3.600	12	1844160000	
20	96.52	3.800	12	1844170000	
21	101.60	4.000	12	1844180000	
22	106.68	4.200	12	1844190000	
23	111.76	4.400	12	1844200000	
24	116.84	4.600	12	1844210000	

**BLT 5.08HC../180LR**

with release bar



Dimensioned drawing

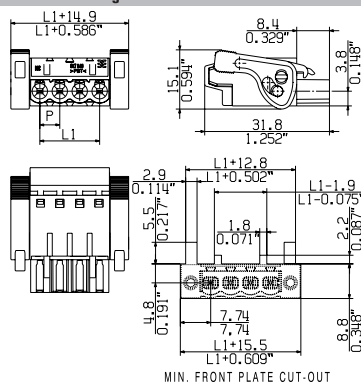

**Ordering data**

Solder pin length					
Colour					Orange
Pitch 5.08 mm					
Pol.	L1	(inch)	Qty.	Order No.	
2	5.08	0.200	90	1890220000	
3	10.16	0.400	72	1890230000	
4	15.24	0.600	60	1890240000	
5	20.32	0.800	48	1890250000	
6	25.40	1.000	42	1890260000	
7	30.48	1.200	36	1890270000	
8	35.56	1.400	36	1890280000	
9	40.64	1.600	30	1890290000	
10	45.72	1.800	30	1890300000	
11	50.80	2.000	24	1890310000	
12	55.88	2.200	24	1890320000	
13	60.96	2.400	24	1890330000	
14	66.04	2.600	18	1890340000	
15	71.12	2.800	18	1890350000	
16	76.20	3.000	18	1890360000	
17	81.28	3.200	18	1890370000	
18	86.36	3.400	18	1890380000	
19	91.44	3.600	12	1890390000	
20	96.52	3.800	12	1890400000	
21	101.60	4.000	12	1890410000	
22	106.68	4.200	12	1890420000	
23	111.76	4.400	12	1890430000	
24	116.84	4.600	12	1890440000	

**The 2-in-1 contact**

Every pluggable connector covers two contact points and thus must meet two different requirements: First, the wire termination and second, the connection between plug and pin header. Referring to the 5.0x pitch series, Weidmüller offers different wire connection technologies, but one platform contact for the male / female connection since years. This well-designed hybride platform contact ensures a constant quality on a very high level. Hybride means, that we combine metal material featuring different characteristics by welding, in order to devide the contact system into different function zones: Further to the high electric conductance, the current bar is characterized by its hardness, and the tulip contact by its excellent tension properties. The advantage: each function is supported by the most suitable material to reliably and constantly meet the different electrical and mechanical requirements. To put it in a nutshell: Instead of either ... or, it's even both - perfect for the current, and perfect for the force.



G

## Connectors in 5.08 mm pitch Series BL/SL 5.08

### BLZ 5.08/./180 QV2

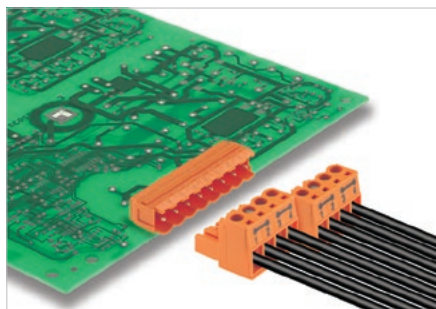

Female plug with clamping yoke screw connection and internal cross-connections for the 1-2 & 3-4 wire connections; with straight wire outlet.

- Bus signals of up to 32 A can be safely looped through
- This permits an interruption-free decoupling of individual modules from the network
- Folded steel clamping yoke accommodates the connected wire and compensates for temperature fluctuations
- The cross-connections are clearly marked

### Product data

IEC: 400 V / 17.5 A / 0.2 - 4 mm<sup>2</sup>  
UL: 300 V / 15 A / AWG 30 - 12



For additional articles and information, refer to [catalog.weidmueller.com](http://catalog.weidmueller.com)

#### Note:

- Additional colours on request
- Gold-plated contact surfaces on request
- Rated current related to rated cross-section & min. No. of poles.
- Wire end ferrule without plastic collar to DIN 46228/1
- Wire end ferrule with plastic collar to DIN 46228/4
- P on drawing = pitch
- Rated data refer only to the component itself. Clearance and creepage distances to other components are to be designed in accordance with the relevant application standards.

### BLZ 5.08/./180 QV2

with cross-connection



#### Dimensioned drawing

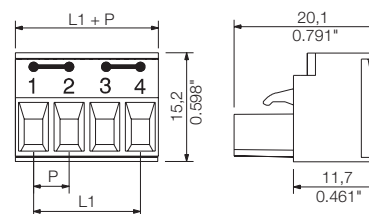

## G

### Technical data

#### In compliance with IEC 60664-1 / IEC 61984

Clamping range, max.	mm <sup>2</sup>	0.13...4
<b>Solid core H05(07) V-U</b>	<b>mm<sup>2</sup></b>	<b>0.2...2.5</b>
Stranded H07 V-R		
Flexible H05(07) V-K	mm <sup>2</sup>	0.2...4
Flexible with ferrule	mm <sup>2</sup>	0.2...2.5
Ferrule with plastic collar	mm <sup>2</sup>	0.2...2.5
Stripping length	mm	7
Screwdriver blade	mm	0.6 x 3.5
According to norm		DIN 5264
Tightening torque range	Nm	0.4...0.5
<b>Rated current, max.</b>		<b>17.5 15</b>
At ambient temperature	20°C	40°C
For conductor cross-section	mm <sup>2</sup>	2.5
Overvoltage category		III III II
Pollution severity		3 2 2
<b>Rated voltage</b>	<b>V</b>	<b>250 320 400</b>
Rated impulse voltage	kV	4 4 4

#### UL / CUL (Use Group)

	B	C	D
<b>Rated voltage</b>	<b>V 300</b>	<b>300</b>	
<b>Rated current</b>	<b>A 15</b>	<b>10</b>	
<b>AWG conductor</b>	<b>AWG 30-12</b>		
<b>CSA (Use Group)</b>	<b>B C D</b>		
Rated voltage	V 300	300	
Rated current	A 15	10	
AWG conductor	AWG 30-12		

#### General data

Type of insulation material	PBT
UL 94 flammability rating	V-0
Contact base material	Copper alloy
Material of contact surface	tinned
Pin dimensions = d	mm
Solder eyelet Ø = D	mm
Solder eyelet Ø tolerance	mm

5.08

180°



1.5 mm<sup>2</sup>

### Accessories

Note: Refer to the Accessories chapter for additional accessories.

Strain relief	Order No.
BLZ 5.08 ZE04 OR BX	<b>1652110000</b>
BLZ 5.08 ZE04 BK BX	<b>1652130000</b>
BLZ 5.08 ZE08 OR BX	<b>1652050000</b>
BLZ 5.08 ZE08 BK BX	<b>1652070000</b>
Coding	
BLZ/SL KO QR BX	<b>1573010000</b>
BLZ/SL KO BK BX	<b>1545710000</b>
Screwdriver	
SDS 0.6X3.5X100	<b>9008330000</b>
SDIS 0.6X3.5X100	<b>9008390000</b>

### Ordering data

Solder pin length				
Colour	<b>Orange</b>			
Pitch	<b>5.08 mm</b>			
Pol.	L1	(inch)	Qty.	Order No.
4	15.24	0.300	90	<b>1839770000</b>

### Representative deratings curve

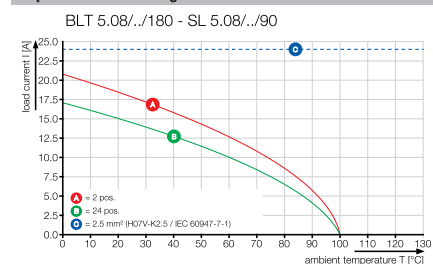



**BLZ 5.08/./180F QV2**

with cross-connection



Dimensioned drawing

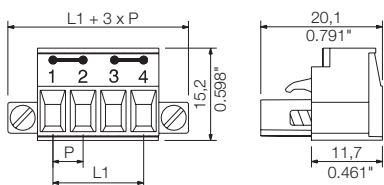

**Ordering data**

Solder pin length				
Colour				Orange
Pitch 5.08 mm				
Pol.	L1	(inch)	Qty.	Order No.
4	15.24	0.300	60	1846870000

**Examples of applications**

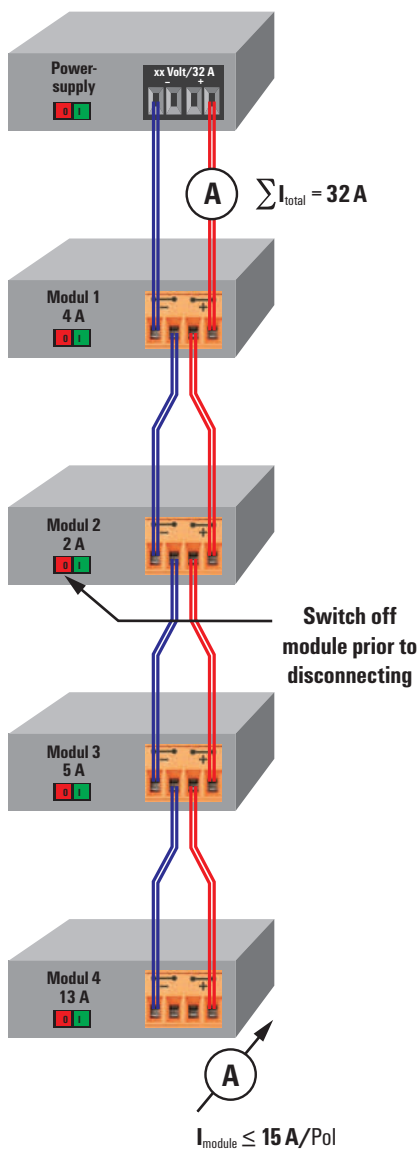

**32 A maximum bus current**  
**15 A maximum module current**

**The 2-in-1 contact**

Every pluggable connector covers two contact points and thus must meet two different requirements: First, the wire termination and second, the connection between plug and pin header. Referring to the 5.0x pitch series, Weidmüller offers different wire connection technologies, but one platform contact for the male / female connection since years. This well-designed hybride platform contact ensures a constant quality on a very high level. Hybride means, that we combine metal material featuring different characteristics by welding, in order to divide the contact system into different function zones: Further to the high electric conductance, the current bar is characterized by its hardness, and the tulip contact by its excellent tension properties. The advantage: each function is supported by the most suitable material to reliably and constantly meet the different electrical and mechanical requirements. To put it in a nutshell: Instead of either ... or, it's even both - perfect for the current, and perfect for the force.



## Connectors in 5.08 mm pitch Series BL/SL 5.08

### SL DN 5.08

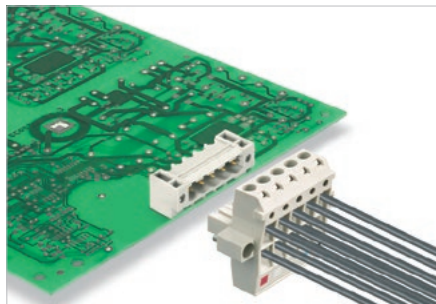

Male headers with gold plated pins in an angled outlet direction, optimised for use with BLZ and BLDZ DN 5.08/180 female plugs. Versions with a screw flange for screwing together male and female plug. The male headers can be coded manually or ordered already precoded. Packed in a cardboard box.

### Technical data

#### In compliance with IEC 60664-1 / IEC 61984

Clamping range, max.			
<b>Solid core H05(07) V-U</b>			
Stranded H07 V-R			
Flexible H05(07) V-K			
Flexible with ferrule			
Ferrule with plastic collar			
Stripping length			
Screwdriver blade	mm		
According to norm			
Tightening torque range			
<b>Rated current, max.</b>	<b>A</b>	<b>18</b>	<b>15</b>
At ambient temperature		20°C	40°C
For conductor cross-section			
Overvoltage category		III	III II
Pollution severity		3	2 2
<b>Rated voltage</b>	<b>V</b>	<b>250</b>	<b>320 400</b>
Rated impulse voltage	kV	4	4 4
<b>UL / CUL (Use Group)</b>		<b>B</b>	<b>C D</b>
<b>Rated voltage</b>	<b>V</b>	<b>300</b>	<b>300</b>
<b>Rated current</b>	<b>A</b>	<b>10</b>	<b>10</b>
<b>AWG conductor</b>	<b>AWG</b>	-	-
<b>CSA (Use Group)</b>		<b>B</b>	<b>C D</b>
Rated voltage	V	300	300
Rated current	A	10	10
AWG conductor	AWG	-	-
<b>General data</b>			
Type of insulation material		PBT	
UL 94 flammability rating		V-0	
Contact base material		CuSn	
Material of contact surface		Gold-plated	
Pin dimensions = d	mm		
Solder eyelet Ø = D	mm	1.3	
Solder eyelet Ø tolerance	mm	+ 0,1	

### Product data

IEC: 400 V / 18 A  
UL: 300 V / 10 A



For additional articles and information, refer to [catalog.weidmueller.com](http://catalog.weidmueller.com)

#### Note:

- Rated current related to rated cross-section & min. No. of poles.
- P on drawing = pitch
- Rated data refer only to the component itself. Clearance and creepage distances to other components are to be designed in accordance with the relevant application standards.

### SL DN 5.08 90F



#### Dimensioned drawing

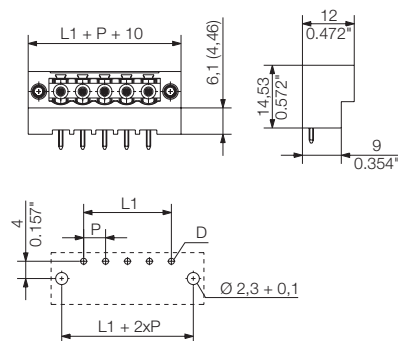

### Accessories

Note: Refer to the Accessories chapter for additional accessories.

Coding	Order No.
BLZ/SL KO OR BX	1573010000
BLZ/SL KO BK BX	1545710000

### Ordering data

Solder pin length		3.5 mm	
Colour		Agate grey	
Pitch	5.08 mm	Qty.	Order No.
5	20.32	0.800	50 1933160000
5	20.32	0.800	50 1933170000



## Connectors in 5.08 mm pitch Series BL/SL 5.08

### BLZ DN 5.08/./180

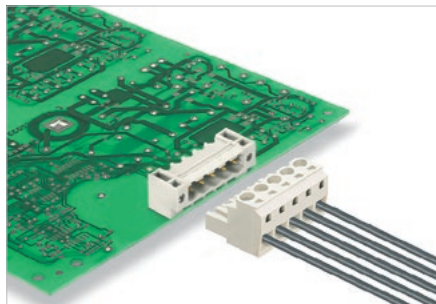

Female plug with clamping yoke screw connection and straight wire outlet; used as terminating piece in bus applications.

- A manual diagnosis can be carried out using the test point.
- The gold-plated contact system can be plugged in and disconnected up to 1000 times.
- DeviceNet colour markings are clearly visible
- Folded steel clamping yoke accommodates the connected wire and compensates for temperature fluctuations
- Available with screw flange (F).

### Product data

IEC: 400 V / 15 A / 0.2 - 2.5 mm<sup>2</sup>  
UL: 300 V / 15 A / AWG 22 - 12



For additional articles and information, refer to [catalog.weidmueller.com](http://catalog.weidmueller.com)

#### Note:

- Additional colours on request
- Rated current related to rated cross-section & min. No. of poles.
- Wire end ferrule without plastic collar to DIN 46228/1
- Wire end ferrule with plastic collar to DIN 46228/4
- P on drawing = pitch
- Rated data refer only to the component itself. Clearance and creepage distances to other components are to be designed in accordance with the relevant application standards.

### BLZ DN 5.08/./180 AU

with test point



#### Dimensioned drawing

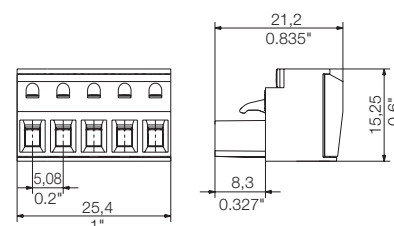

## G

### Technical data

In compliance with IEC 60664-1 / IEC 61984			
Clamping range, max.	mm <sup>2</sup>	0.13...3.31	
<b>Solid core H05(07) V-U</b>	<b>mm<sup>2</sup></b>	<b>0.2...2.5</b>	
Stranded H07 V-R			
Flexible H05(07) V-K	mm <sup>2</sup>	0.2...2.5	
Flexible with ferrule	mm <sup>2</sup>	0.2...2.5	
Ferrule with plastic collar	mm <sup>2</sup>	0.2...2.5	
Stripping length	mm	7	
Screwdriver blade	mm	0.6 x 3.5	
		According to norm	
Tightening torque range	Nm	0.4...0.5	
<b>Rated current, max.</b>	<b>A</b>	<b>15</b>	<b>12</b>
At ambient temperature		20°C	40°C
For conductor cross-section	mm <sup>2</sup>	2.5	
Overvoltage category		III	III II
Pollution severity		3	2 2
<b>Rated voltage</b>	<b>V</b>	<b>250</b>	<b>320 400</b>
Rated impulse voltage	kV	4	4 4
<b>UL / CUL (Use Group)</b>		<b>B</b>	<b>C D</b>
<b>Rated voltage</b>	<b>V</b>	<b>300</b>	<b>300</b>
<b>Rated current</b>	<b>A</b>	<b>15</b>	<b>10</b>
<b>AWG conductor</b>	<b>AWG</b>	<b>22-12</b>	
<b>CSA (Use Group)</b>		<b>B</b>	<b>C D</b>
Rated voltage	V	300	300
Rated current	A	15	10
AWG conductor	AWG	26-12	
<b>General data</b>			
Type of insulation material		PBT	
UL 94 flammability rating		V-0	
Contact base material		Copper alloy	
Material of contact surface		Gold-plated	
Pin dimensions = d	mm		
Solder eyelet Ø = D	mm		
Solder eyelet Ø tolerance	mm		

### Accessories

Note: Refer to the Accessories chapter for additional accessories.

Strain relief		Order No.
	BLZ 5.08 ZE04 OR BX	1652110000
	BLZ 5.08 ZE04 BK BX	1652130000
Coding		
	BLZ/SL KO OR BX	1573010000
	BLZ/SL KO BK BX	1545710000
Screwdriver		
	SDS 0.6X3.5X100	9008330000
	SDIS 0.6X3.5X100	9008390000

### Ordering data

Solder pin length				
Colour				Pebble grey
Pitch	5.08 mm			
Pol.	L1	(inch)	Qty.	Order No.
5	20.32	0.800	50	1933560000

### Representative deratings curve

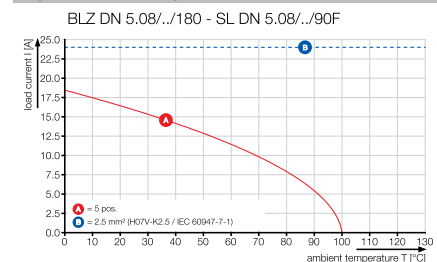

5.08

180°

1.5 mm<sup>2</sup>

## BLZ DN 5.08/./180F AU

with test point and connector guide



Dimensioned drawing

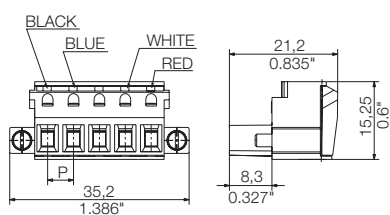

### Ordering data

Solder pin length				
Colour		Pebble grey		
Pitch		5.08 mm		
Pol.	L1	(inch)	Qty.	Order No.
5	20.32	0.800	50	1933550000
5	20.32	0.800	50	1933570000

### The 2-in-1 contact

Every pluggable connector covers two contact points and thus must meet two different requirements: First, the wire termination and second, the connection between plug and pin header. Referring to the 5.0x pitch series, Weidmüller offers different wire connection technologies, but one platform contact for the male / female connection since years. This well-designed hybride platform contact ensures a constant quality on a very high level. Hybride means, that we combine metal material featuring different characteristics by welding, in order to devide the contact system into different function zones: Further to the high electric conductance, the current bar is characterized by its hardness, and the tulip contact by its excellent tension properties. The advantage: each function is supported by the most suitable material to reliably and constantly meet the different electrical and mechanical requirements. To put it in a nutshell: Instead of either ... or, it 's even both - perfect for the current, and perfect for the force.



## Connectors in 5.08 mm pitch Series BL/SL 5.08

### BLDZ DN 5.08/./180F

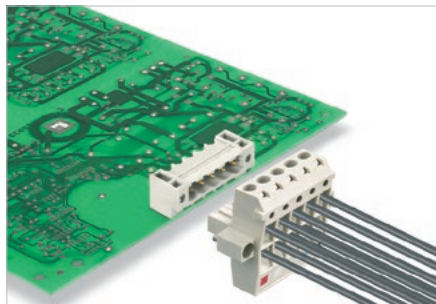

Bus plug with two connections per pole, with clamping yoke screw connection

- Bus signals can be safely looped through (e.g., DeviceNet)
- This permits an interruption-free decoupling of individual modules from the network.
- A manual diagnosis can be carried out using the test point.
- The gold-plated contact system can be plugged in and disconnected up to 1000 times.
- DeviceNet colour markings are clearly visible
- Folded steel clamping yoke accommodates the connected wire and compensates for temperature fluctuations

### Product data

IEC: 400 V / 16 A / 0.2 - 2.5 mm<sup>2</sup>  
UL: 300 V / 15 A / AWG 22 - 12



For additional articles and information, refer to [catalog.weidmueller.com](http://catalog.weidmueller.com)

#### Note:

- Additional colours on request
- Rated current related to rated cross-section & min. No. of poles.
- Wire end ferrule without plastic collar to DIN 46228/1
- Wire end ferrule with plastic collar to DIN 46228/4
- P on drawing = pitch
- Rated data refer only to the component itself. Clearance and creepage distances to other components are to be designed in accordance with the relevant application standards.

### BLDZ DN 5.08/./180F AU

with test point and connector guide



#### Dimensioned drawing

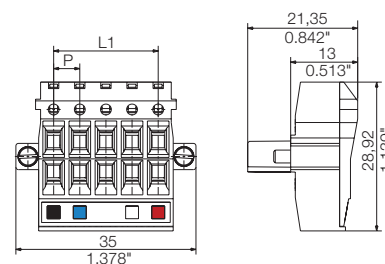

## G

### Technical data

#### In compliance with IEC 60664-1 / IEC 61984

Clamping range, max.	mm <sup>2</sup>	0.13...2.5
<b>Solid core H05(07) V-U</b>	<b>mm<sup>2</sup></b>	<b>0.2...2.5</b>
Stranded H07 V-R		
Flexible H05(07) V-K	mm <sup>2</sup>	0.2...2.5
Flexible with ferrule	mm <sup>2</sup>	0.2...2.5
Ferrule with plastic collar	mm <sup>2</sup>	0.2...2.5
Stripping length	mm	7
Screwdriver blade	mm	0.6 x 3.5
According to norm		DIN 5264
Tightening torque range	Nm	0.4...0.5
<b>Rated current, max.</b>	<b>A</b>	<b>16 14</b>
At ambient temperature		20°C 40°C
For conductor cross-section	mm <sup>2</sup>	2.5
Overtoltage category		III III II
Pollution severity		3 2 2
<b>Rated voltage</b>	<b>V</b>	<b>250 320 400</b>
Rated impulse voltage	kV	4 4 4
<b>UL / CUL (Use Group)</b>	<b>B C D</b>	<b>4 4 4</b>
<b>Rated voltage</b>	<b>V</b>	<b>300 300</b>
<b>Rated current</b>	<b>A</b>	<b>15 10</b>
<b>AWG conductor</b>	<b>AWG</b>	<b>22-12</b>
<b>CSA (Use Group)</b>	<b>B C D</b>	<b>4 4 4</b>
Rated voltage	V	300 300
Rated current	A	15 10
AWG conductor	AWG	26-12

#### General data

Type of insulation material		PBT
UL 94 flammability rating		V-0
Contact base material		Copper alloy
Material of contact surface		Gold-plated
Pin dimensions = d	mm	
Solder eyelet Ø = D	mm	
Solder eyelet Ø tolerance	mm	

### Accessories

Note: Refer to the Accessories chapter for additional accessories.

Coding	Order No.
BLZ/SL KO OR BX	<b>1573010000</b>
BLZ/SL KO BK BX	<b>1545710000</b>
Screwdriver	
SDS 0.6X3.5X100	<b>9008330000</b>
SDIS 0.6X3.5X100	<b>9008390000</b>

### Ordering data

<b>Solder pin length</b>				
<b>Colour</b>	<b>Pebble grey</b>			
<b>Pitch</b>	<b>5.08 mm</b>			
Pol.	L1	(inch)	Qty.	Order No.
5	20.32	0.800	50	<b>1919990000</b>

### Representative deratings curve

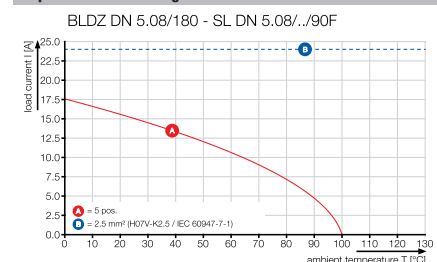

5.08

180°



1.5 mm<sup>2</sup>

## The 2-in-1 contact

---

Every pluggable connector covers two contact points and thus must meet two different requirements: First, the wire termination and second, the connection between plug and pin header. Referring to the 5.0x pitch series, Weidmüller offers different wire connection technologies, but one platform contact for the male / female connection since years. This well-designed hybride platform contact ensures a constant quality on a very high level.

Hybride means, that we combine metal material featuring different characteristics by welding, in order to devide the contact system into different function zones: Further to the high electric conductance, the current bar is characterized by its hardness, and the tulip contact by its excellent tension properties. The advantage: each function is supported by the most suitable material to reliably and constantly meet the different electrical and mechanical requirements. To put it in a nutshell: Instead of either ... or, it 's even both - perfect for the current, and perfect for the force.



## Connectors in 5.08 mm pitch Series BL/SL 5.08

### BLDT 5.08/./180

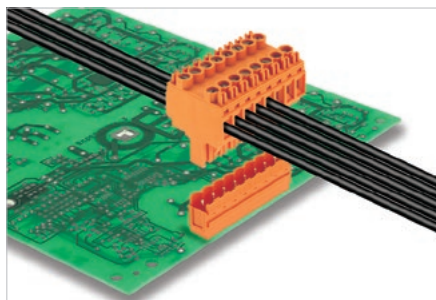

Bus plug with two connections per pole, with clamping yoke screw connection

- Bus signals can be safely looped through
- This permits an interruption-free decoupling of individual modules from the network.
- Large labelling area on the top side
- Folded steel clamping yoke accommodates the connected wire and compensates for temperature fluctuations

### Product data

IEC: 400 V / 14 A / 0.2 - 2.5 mm<sup>2</sup>  
UL: 300 V / 10 A / AWG 26 - 12



For additional articles and information, refer to [catalog.weidmueller.com](http://catalog.weidmueller.com)

#### Note:

- Additional colours on request
- Gold-plated contact surfaces on request
- Rated current related to rated cross-section & min. No. of poles.
- Wire end ferrule without plastic collar to DIN 46228/1
- Wire end ferrule with plastic collar to DIN 46228/4
- P on drawing = pitch
- Rated data refer only to the component itself. Clearance and creepage distances to other components are to be designed in accordance with the relevant application standards.

### BLDT 5.08/./180



#### Dimensioned drawing

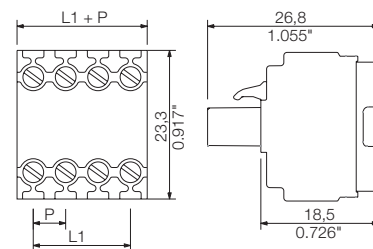

## G

### Technical data

#### In compliance with IEC 60664-1 / IEC 61984

Clamping range, max.	mm <sup>2</sup>	0.13...3.31
<b>Solid core H05(07) V-U</b>	<b>mm<sup>2</sup></b>	<b>0.2...2.5</b>
Stranded H07 V-R		
Flexible H05(07) V-K	mm <sup>2</sup>	0.2...2.5
Flexible with ferrule	mm <sup>2</sup>	0.2...1.5
Ferrule with plastic collar	mm <sup>2</sup>	0.2...1.5
Stripping length	mm	7
Screwdriver blade	mm	0.6 x 3.5
According to norm		DIN 5264
Tightening torque range	Nm	0.4...0.5
<b>Rated current, max.</b>	<b>A</b>	<b>14 12</b>
At ambient temperature	20°C	40°C
For conductor cross-section	mm <sup>2</sup>	2.5
Overtoltage category		III III II
Pollution severity		3 2 2
<b>Rated voltage</b>	<b>V</b>	<b>250 320 400</b>
Rated impulse voltage	kV	4 4 4

#### UL / CUL (Use Group)

	<b>B</b>	<b>C</b>	<b>D</b>
<b>Rated voltage</b>	<b>V</b>	<b>300</b>	<b>300</b>
<b>Rated current</b>	<b>A</b>	<b>10</b>	<b>10</b>
<b>AWG conductor</b>	<b>AWG</b>	<b>26-12</b>	
<b>CSA (Use Group)</b>	<b>B</b>	<b>C</b>	<b>D</b>
Rated voltage	V	300	300
Rated current	A	10	10
AWG conductor	AWG	26-12	

#### General data

Type of insulation material	PBT
UL 94 flammability rating	V-0
Contact base material	Copper alloy
Material of contact surface	tinned
Pin dimensions = d	mm
Solder eyelet Ø = D	mm
Solder eyelet Ø tolerance	mm

### Accessories

Note: Refer to the Accessories chapter for additional accessories.

Coding	Order No.
BLZ/SL KO OR BX	<b>1573010000</b>
BLZ/SL KO BK BX	<b>1545710000</b>
Screwdriver	
SDS 0.6X3.5X100	<b>9008330000</b>
SDIS 0.6X3.5X100	<b>9008390000</b>

### Ordering data

Solder pin length				
Colour	Orange			
Pitch	5.08 mm			
Pol.	L1	(inch)	Qty.	Order No.
2	5.08	0.200	150	<b>1644730000</b>
3	10.16	0.400	100	<b>1644740000</b>
4	15.24	0.600	75	<b>1644750000</b>
5	20.32	0.800	60	<b>1644760000</b>
6	25.40	1.000	50	<b>1644770000</b>
7	30.48	1.200	40	<b>1644780000</b>
8	35.56	1.400	35	<b>1644790000</b>
9	40.64	1.600	30	<b>1644800000</b>
10	45.72	1.800	30	<b>1644810000</b>
11	50.80	2.000	25	<b>1644820000</b>
12	55.88	2.200	25	<b>1644830000</b>

### Representative deratings curve

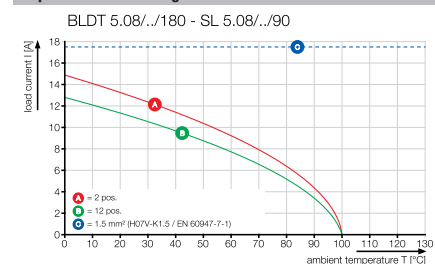



**BLDT 5.08/./180B**



Dimensioned drawing

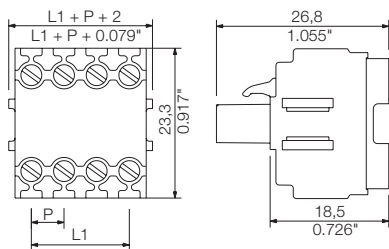

**Ordering data**

<b>Solder pin length</b>				
<b>Colour</b>	Orange			
<b>Pitch</b>	5.08 mm			
Pol.	L1	(inch)	Qty.	Order No.
2	5.08	0.200	130	1651740000
3	10.16	0.400	90	1651750000
4	15.24	0.600	70	1651760000
5	20.32	0.800	55	1651770000
6	25.40	1.000	45	1651780000
7	30.48	1.200	40	1651790000
8	35.56	1.400	35	1651800000
9	40.64	1.600	30	1651810000
10	45.72	1.800	25	1651820000
11	50.80	2.000	25	1651830000
12	55.88	2.200	20	1651840000

**The 2-in-1 contact**

Every pluggable connector covers two contact points and thus must meet two different requirements: First, the wire termination and second, the connection between plug and pin header. Referring to the 5.0x pitch series, Weidmüller offers different wire connection technologies, but one platform contact for the male / female connection since years. This well-designed hybride platform contact ensures a constant quality on a very high level. Hybride means, that we combine metal material featuring different characteristics by welding, in order to devide the contact system into different function zones: Further to the high electric conductance, the current bar is characterized by its hardness, and the tulip contact by its excellent tension properties. The advantage: each function is supported by the most suitable material to reliably and constantly meet the different electrical and mechanical requirements. To put it in a nutshell: Instead of either ... or, it 's even both - perfect for the current, and perfect for the force.



## Connectors in 5.08 mm pitch Series BL/SL 5.08

### BLF 5.08HC../180

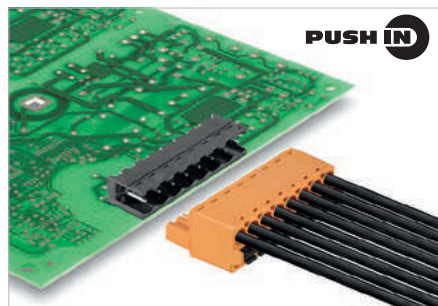

"PUSH IN" - Weidmüller's innovative connection system simplifies and accelerates the wire connection process.

- Solid wires and stranded wires with ferrules need only to be inserted and they are ready.
- The actuator must be used when connecting stranded wires without ferrules.
- Intuitive handling - since the wire-entry area and handling area are clearly separated.
- User-friendly handling with rounded outer edges and large, no-slip push buttons.
- Lock and release lever: tool-less locking and a gentle releasing of the connector reduces the mechanical stress to the solder joints.

### Product data

IEC: 400 V / 24 A / 0.2 - 2.5 mm<sup>2</sup>  
UL: 300 V / 18.5 A / AWG 26 - 12



For additional articles and information, refer to [catalog.weidmueller.com](http://catalog.weidmueller.com)

#### Note:

- Additional colours on request
- Gold-plated contact surfaces on request
- Rated current related to rated cross-section & min. No. of poles.
- Wire end ferrule without plastic collar to DIN 46228/1
- Wire end ferrule with plastic collar to DIN 46228/4
- P on drawing = pitch

### BLF 5.08HC../180



#### Dimensioned drawing

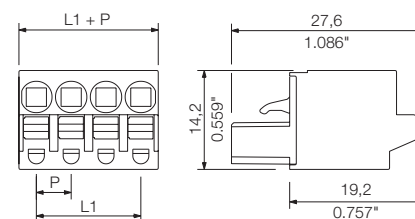

### Technical data

In compliance with IEC 60664-1 / IEC 61984			
Clamping range, max.	mm <sup>2</sup>	0.13...3.31	
<b>Solid core H05(07) V-U</b>	mm <sup>2</sup>	<b>0.2...2.5</b>	
Stranded H07 V-R			
Flexible H05(07) V-K	mm <sup>2</sup>	0.2...2.5	
Flexible with ferrule	mm <sup>2</sup>	0.25...2.5	
Ferrule with plastic collar	mm <sup>2</sup>	0.25...2.5	
Stripping length	mm	10	
Screwdriver blade	mm	0.6 x 3.5	
According to norm			
Tightening torque range			
<b>Rated current, max.</b>	<b>A</b>	<b>24</b>	<b>21</b>
At ambient temperature		20°C	40°C
For conductor cross-section	mm <sup>2</sup>	2.5	
Overvoltage category		III	III II
Pollution severity		3	2 2
<b>Rated voltage</b>	<b>V</b>	<b>250</b>	<b>320 400</b>
Rated impulse voltage	kV	4	4 4
<b>UL / CUL (Use Group)</b>		<b>B</b>	<b>C D</b>
<b>Rated voltage</b>	<b>V</b>	<b>300</b>	<b>300</b>
<b>Rated current</b>	<b>A</b>	<b>18.5</b>	<b>10</b>
<b>AWG conductor</b>	<b>AWG</b>	<b>26-12</b>	
<b>CSA (Use Group)</b>		<b>B</b>	<b>C D</b>
Rated voltage	V	300	300
Rated current	A		10
AWG conductor	AWG	26-12	
General data			
Type of insulation material		PBT	
UL 94 flammability rating		V-0	
Contact base material		CuSn	
Material of contact surface		tinned	
Pin dimensions = d	mm		
Solder eyelet Ø = D	mm		
Solder eyelet Ø tolerance	mm		

### Accessories

Note: Refer to the Accessories chapter for additional accessories.

Coding	Order No.
BLZ/SL KO OR BX	<b>1573010000</b>
BLZ/SL KO BK BX	<b>1545710000</b>
Screwdriver	
SDS 0.6X3.5X100	<b>9008330000</b>
SDIS 0.6X3.5X100	<b>9008390000</b>
Wire-end ferrule	
H0,5/14S W	<b>9004590000</b>
H1,0/14S R	<b>9018560000</b>
H1,5/14S SW	<b>9025240000</b>
H2,5/14S BL	<b>1333100000</b>

### Ordering data

Solder pin length				
Colour	Orange			
Pitch	5.08 mm			
Pol.	L1	(inch)	Qty.	Order No.
2	5.08	0.200	180	<b>1013680000</b>
3	10.16	0.400	120	<b>1013690000</b>
4	15.24	0.600	90	<b>1013710000</b>
5	20.32	0.800	72	<b>1013720000</b>
6	25.40	1.000	60	<b>1013730000</b>
7	30.48	1.200	48	<b>1013740000</b>
8	35.56	1.400	42	<b>1013750000</b>
9	40.64	1.600	36	<b>1013760000</b>
10	45.72	1.800	36	<b>1013770000</b>
11	50.80	2.000	30	<b>1013780000</b>
12	55.88	2.200	30	<b>1013790000</b>
13	60.96	2.400	24	<b>1013810000</b>
14	66.04	2.600	24	<b>1013820000</b>
15	71.12	2.800	24	<b>1013830000</b>
16	76.20	3.000	18	<b>1013840000</b>
17	81.28	3.200	18	<b>1013850000</b>
18	86.36	3.400	18	<b>1013860000</b>
19	91.44	3.600	18	<b>1013870000</b>
20	96.52	3.800	18	<b>1013880000</b>
21	101.60	4.000	12	<b>1013890000</b>
22	106.68	4.200	12	<b>1013910000</b>
23	111.76	4.400	12	<b>1013920000</b>
24	116.84	4.600	12	<b>1013930000</b>

### Representative deratings curve

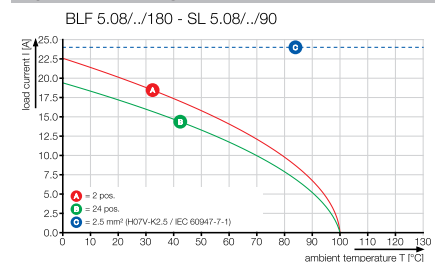

**BLF 5.08HC../180F**



Dimensioned drawing

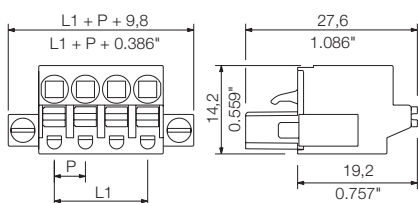

**Ordering data**

Solder pin length					
Colour					Orange
Pitch	5.08 mm				
Pol.	L1	(inch)	Qty.	Order No.	
2	5.08	0.200	90	1013070000	
3	10.16	0.400	72	1013090000	
4	15.24	0.600	60	1013110000	
5	20.32	0.800	48	1013120000	
6	25.40	1.000	42	1013130000	
7	30.48	1.200	36	1013140000	
8	35.56	1.400	36	1013150000	
9	40.64	1.600	30	1013160000	
10	45.72	1.800	30	1013170000	
11	50.80	2.000	24	1013180000	
12	55.88	2.200	24	1013190000	
13	60.96	2.400	24	1013210000	
14	66.04	2.600	18	1013220000	
15	71.12	2.800	18	1013230000	
16	76.20	3.000	18	1013240000	
17	81.28	3.200	18	1013250000	
18	86.36	3.400	18	1013260000	
19	91.44	3.600	12	1013270000	
20	96.52	3.800	12	1013280000	
21	101.60	4.000	12	1013290000	
22	106.68	4.200	12	1013310000	
23	111.76	4.400	12	1013320000	
24	116.84	4.600	12	1013330000	

**BLF 5.08HC../180LR**

with release latch



Dimensioned drawing

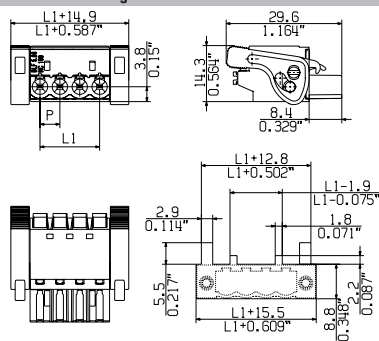

MIN. FRONT PLATE CUT-OUT

**Ordering data**

Solder pin length					
Colour					Orange
Pitch	5.08 mm				
Pol.	L1	(inch)	Qty.	Order No.	
2	5.08	0.200	90	1014370000	
3	10.16	0.400	72	1014380000	
4	15.24	0.600	60	1014390000	
5	20.32	0.800	48	1014410000	
6	25.40	1.000	42	1014420000	
7	30.48	1.200	36	1014430000	
8	35.56	1.400	36	1014440000	
9	40.64	1.600	30	1014450000	
10	45.72	1.800	30	1014460000	
11	50.80	2.000	24	1014470000	
12	55.88	2.200	24	1014480000	
13	60.96	2.400	24	1014490000	
14	66.04	2.600	18	1014510000	
15	71.12	2.800	18	1014520000	
16	76.20	3.000	18	1014530000	
17	81.28	3.200	18	1014540000	
18	86.36	3.400	18	1014550000	
19	91.44	3.600	12	1014560000	
20	96.52	3.800	12	1014570000	
21	101.60	4.000	12	1014580000	
22	106.68	4.200	12	1014590000	
23	111.76	4.400	12	1014610000	
24	116.84	4.600	12	1014620000	

**PUSH IN connection technology**

"PUSH IN" connection technology reduces the wiring efforts especially for solid wires and wires with ferrule to a minimum. These connectors are self-explanatory and enable tool-less handling. The contact element made of stainless steel ensures a vibration proof, maintenance free wire termination. The established principle "STEEL FOR THE FORCE, COPPER FOR THE CURRENT" by Weidmüller offers both, maximum conductor clamping forces, as well as minimum power loss at the same time.



**The 2-in-1 contact**

Every pluggable connector covers two contact points and thus must meet two different requirements: First, the wire termination and second, the connection between plug and pin header. Referring to the 5.0x pitch series, Weidmüller offers different wire connection technologies, but one platform contact for the male / female connection since years. This well-designed hybride platform contact ensures a constant quality on a very high level. Hybride means, that we combine metal material featuring different characteristics by welding, in order to divide the contact system into different function zones: Further to the high electric conductance, the current bar is characterized by its hardness, and the tulip contact by its excellent tension properties. The advantage: each function is supported by the most suitable material to reliably and constantly meet the different electrical and mechanical requirements. To put it in a nutshell: Instead of either ... or, it's even both - perfect for the current, and perfect for the force.



## Connectors in 5.08 mm pitch Series BL/SL 5.08

### BLF 5.08HC../90

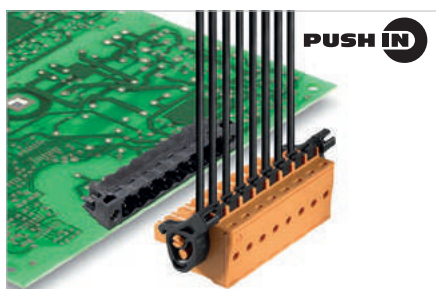

"PUSH IN" - Weidmüller's innovative connection system simplifies and accelerates the wire connection process.

- Solid wires and stranded wires with ferrules need only to be inserted and they are ready.
- The actuator must be used when connecting stranded wires without ferrules.
- Intuitive handling - since the wire-entry area and handling area are clearly separated.
- User-friendly handling with rounded outer edges and large, no-slip push buttons.
- Lock and release lever: tool-less locking and a gentle releasing of the connector reduces the mechanical stress to the solder joints.

### Product data

IEC: 400 V / 24 A / 0.2 - 2.5 mm<sup>2</sup>  
UL: 300 V / 18.5 A / AWG 26 - 12



For additional articles and information, refer to [catalog.weidmueller.com](http://catalog.weidmueller.com)

#### Note:

- Additional colours on request
- Gold-plated contact surfaces on request
- Rated current related to rated cross-section & min. No. of poles.
- Wire end ferrule without plastic collar to DIN 46228/1
- Wire end ferrule with plastic collar to DIN 46228/4
- P on drawing = pitch

### BLF 5.08HC../90



#### Dimensioned drawing

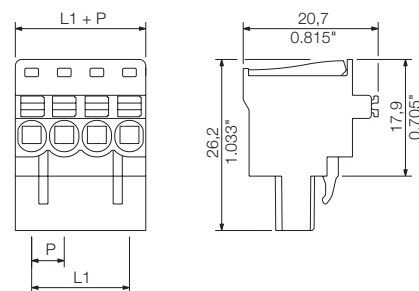

### Technical data

In compliance with IEC 60664-1 / IEC 61984			
Clamping range, max.	mm <sup>2</sup>	0.13...3.31	
<b>Solid core H05(07) V-U</b>	<b>mm<sup>2</sup></b>	<b>0.2...2.5</b>	
Stranded H07 V-R			
Flexible H05(07) V-K	mm <sup>2</sup>	0.2...2.5	
Flexible with ferrule	mm <sup>2</sup>	0.25...2.5	
Ferrule with plastic collar	mm <sup>2</sup>	0.25...2.5	
Stripping length	mm	10	
Screwdriver blade	mm	0.6 x 3.5	
According to norm			
Tightening torque range			
<b>Rated current, max.</b>	<b>A</b>	<b>24</b>	<b>21</b>
At ambient temperature		20°C	40°C
For conductor cross-section	mm <sup>2</sup>	2.5	
Overvoltage category		III	III II
Pollution severity		3	2 2
<b>Rated voltage</b>	<b>V</b>	<b>250</b>	<b>320 400</b>
Rated impulse voltage	kV	4	4 4
<b>UL / CUL (Use Group)</b>		<b>B</b>	<b>C D</b>
<b>Rated voltage</b>	<b>V</b>	<b>300</b>	<b>300</b>
<b>Rated current</b>	<b>A</b>	<b>18.5</b>	<b>10</b>
<b>AWG conductor</b>	<b>AWG</b>	<b>26-12</b>	
<b>CSA (Use Group)</b>		<b>B</b>	<b>C D</b>
Rated voltage	V	300	300
Rated current	A	10	10
AWG conductor	AWG	12-26	
General data			
Type of insulation material		PBT	
UL 94 flammability rating		V-0	
Contact base material		CuSn	
Material of contact surface		tinned	
Pin dimensions = d	mm		
Solder eyelet Ø = D	mm		
Solder eyelet Ø tolerance	mm		

### Accessories

Note: Refer to the Accessories chapter for additional accessories.

Coding	Order No.
BLZ/SL KO OR BX	<b>1573010000</b>
BLZ/SL KO BK BX	<b>1545710000</b>
Screwdriver	
SDS 0.6X3.5X100	<b>9008330000</b>
SDIS 0.6X3.5X100	<b>9008390000</b>
Wire-end ferrule	
H0,5/14S W	<b>9004590000</b>
H1,0/14S R	<b>9018560000</b>
H1,5/14S SW	<b>9025240000</b>
H2,5/14S BL	<b>1333100000</b>

### Ordering data

Solder pin length				
Colour	Orange			
Pitch	5.08 mm			
Pol.	L1	(inch)	Qty.	Order No.
2	5.08	0.200	180	<b>1001530000</b>
3	10.16	0.400	120	<b>1001540000</b>
4	15.24	0.600	90	<b>1001550000</b>
5	20.32	0.800	72	<b>1001560000</b>
6	25.40	1.000	60	<b>1001570000</b>
7	30.48	1.200	48	<b>1001580000</b>
8	35.56	1.400	42	<b>1001590000</b>
9	40.64	1.600	36	<b>1001600000</b>
10	45.72	1.800	36	<b>1001610000</b>
11	50.80	2.000	30	<b>1001620000</b>
12	55.88	2.200	30	<b>1001630000</b>
13	60.96	2.400	24	<b>1001640000</b>
14	66.04	2.600	24	<b>1001650000</b>
15	71.12	2.800	24	<b>1001660000</b>
16	76.20	3.000	18	<b>1001670000</b>
17	81.28	3.200	18	<b>1001680000</b>
18	86.36	3.400	18	<b>1001690000</b>
19	91.44	3.600	18	<b>1001700000</b>
20	96.52	3.800	18	<b>1001710000</b>

### Representative deratings curve

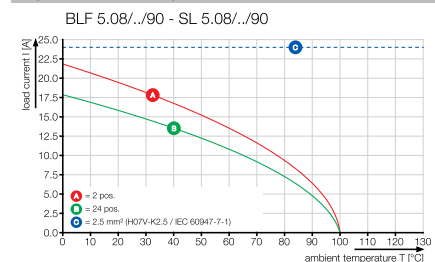

**BLF 5.08HC../90F**



Dimensioned drawing

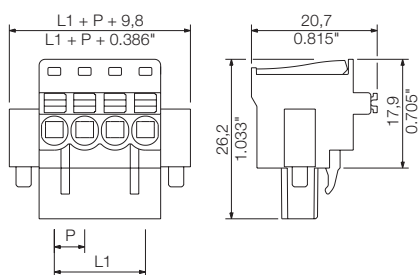

**Ordering data**

Solder pin length					
Colour					Orange
Pitch	5.08 mm				
Pol.	L1	(inch)	Qty.	Order No.	
2	5.08	0.200	90	1002090000	
3	10.16	0.400	72	1002100000	
4	15.24	0.600	60	1002110000	
5	20.32	0.800	48	1002120000	
6	25.40	1.000	42	1002130000	
7	30.48	1.200	36	1002140000	
8	35.56	1.400	36	1002150000	
9	40.64	1.600	30	1002160000	
10	45.72	1.800	30	1002170000	
11	50.80	2.000	24	1002180000	
12	55.88	2.200	24	1002190000	
13	60.96	2.400	24	1002200000	
14	66.04	2.600	18	1002210000	
15	71.12	2.800	18	1002220000	
16	76.20	3.000	18	1002230000	
17	81.28	3.200	18	1002240000	
18	86.36	3.400	18	1002250000	
19	91.44	3.600	12	1002260000	
20	96.52	3.800	12	1002270000	

**BLF 5.08HC../90LR**

with release latch



Dimensioned drawing

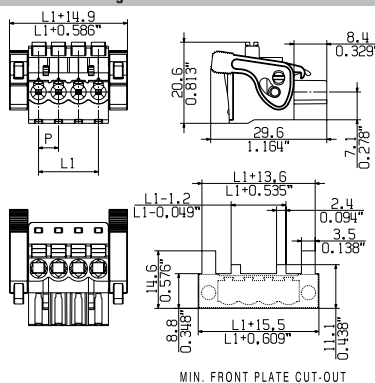

**Ordering data**

Solder pin length					
Colour					Orange
Pitch	5.08 mm				
Pol.	L1	(inch)	Qty.	Order No.	
2	5.08	0.200	90	1002280000	
3	10.16	0.400	72	1002290000	
4	15.24	0.600	60	1002300000	
5	20.32	0.800	48	1002310000	
6	25.40	1.000	42	1002320000	
7	30.48	1.200	36	1002330000	
8	35.56	1.400	36	1002340000	
9	40.64	1.600	30	1002350000	
10	45.72	1.800	30	1002360000	
11	50.80	2.000	24	1002370000	
12	55.88	2.200	24	1002380000	
13	60.96	2.400	24	1002390000	
14	66.04	2.600	18	1002400000	
15	71.12	2.800	18	1002410000	
16	76.20	3.000	18	1002420000	
17	81.28	3.200	18	1002430000	
18	86.36	3.400	18	1002440000	
19	91.44	3.600	12	1002450000	
20	96.52	3.800	12	1002460000	

**PUSH IN connection technology**

"PUSH IN" connection technology reduces the wiring affords especially for solid wires and wires with ferrule to a minimum. These connectors are self-explanatory and enable tool-less handling. The contact element made of stainless steel ensures a vibration proof, maintenance free wire termination. The established principle "STEEL FOR THE FORCE, COPPER FOR THE CURRENT" by Weidmüller offers both, maximum conductor clamping forces, as well as minimum power loss at the same time.



**The 2-in-1 contact**

Every pluggable connector covers two different requirements: First, the wire termination and second, the connection between plug and pin header. Referring to the 5.0x pitch series, Weidmüller offers different wire connection technologies, but one platform contact for the male / female connection since years. This well-designed hybride platform contact ensures a constant quality on a very high level. Hybride means, that we combine metal material featuring different characteristics by welding, in order to divide the contact system into different function zones: Further to the high electric conductance, the current bar is characterized by its hardness, and the tulip contact by its excellent tension properties. The advantage: each function is supported by the most suitable material to reliably and constantly meet the different electrical and mechanical requirements. To put it in a nutshell: Instead of either ... or, it's even both - perfect for the current, and perfect for the force.



## Connectors in 5.08 mm pitch Series BL/SL 5.08

### BLF 5.08HC../270

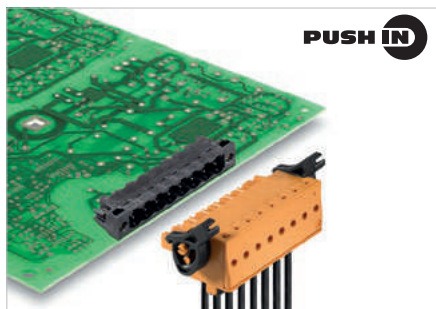

"PUSH IN" - Weidmüller's innovative connection system simplifies and accelerates the wire connection process.

- Solid wires and stranded wires with ferrules need only to be inserted and they are ready.
- The actuator must be used when connecting stranded wires without ferrules.
- Intuitive handling - since the wire-entry area and handling area are clearly separated.
- User-friendly handling with rounded outer edges and large, no-slip push buttons.
- Lock and release lever: tool-less locking and a gentle releasing of the connector reduces the mechanical stress to the solder joints.

### Product data

IEC: 400 V / 24 A / 0.2 - 2.5 mm<sup>2</sup>  
UL: 300 V / 18.5 A / AWG 26 - 12



For additional articles and information, refer to [catalog.weidmueller.com](http://catalog.weidmueller.com)

#### Note:

- Additional colours on request
- Gold-plated contact surfaces on request
- Rated current related to rated cross-section & min. No. of poles.
- Wire end ferrule without plastic collar to DIN 46228/1
- Wire end ferrule with plastic collar to DIN 46228/4
- P on drawing = pitch

### BLF 5.08HC../270



#### Dimensioned drawing

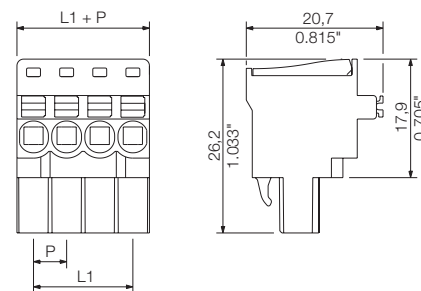

### Technical data

In compliance with IEC 60664-1 / IEC 61984			
Clamping range, max.	mm <sup>2</sup>	0.13...3.31	
<b>Solid core H05(07) V-U</b>	mm <sup>2</sup>	<b>0.2...2.5</b>	
Stranded H07 V-R			
Flexible H05(07) V-K	mm <sup>2</sup>	0.2...2.5	
Flexible with ferrule	mm <sup>2</sup>	0.25...2.5	
Ferrule with plastic collar	mm <sup>2</sup>	0.25...2.5	
Stripping length	mm	10	
Screwdriver blade	mm	0.6 x 3.5	
According to norm			
Tightening torque range		DIN 5264	
<b>Rated current, max.</b>	<b>A</b>	<b>24</b>	<b>21</b>
At ambient temperature 20°C 40°C			
For conductor cross-section	mm <sup>2</sup>	2.5	
Overvoltage category		III	III II
Pollution severity		3	2 2
<b>Rated voltage</b>	<b>V</b>	<b>250</b>	<b>320 400</b>
Rated impulse voltage	kV	4	4 4
<b>UL / CUL (Use Group)</b>		<b>B</b>	<b>C D</b>
<b>Rated voltage</b>	<b>V</b>	<b>300</b>	<b>300</b>
<b>Rated current</b>	<b>A</b>	<b>18.5</b>	<b>10</b>
<b>AWG conductor</b>	<b>AWG</b>	<b>26-12</b>	
<b>CSA (Use Group)</b>		<b>B</b>	<b>C D</b>
Rated voltage	V	300	300
Rated current	A	10	10
AWG conductor	AWG	12-26	
General data			
Type of insulation material		PBT	
UL 94 flammability rating		V-0	
Contact base material		CuSn	
Material of contact surface		tinned	
Pin dimensions = d	mm		
Solder eyelet Ø = D	mm		
Solder eyelet Ø tolerance	mm		

### Accessories

Note: Refer to the Accessories chapter for additional accessories.

Coding	Order No.
BLZ/SL KO OR BX	<b>1573010000</b>
BLZ/SL KO BK BX	<b>1545710000</b>
Screwdriver	
SDS 0.6X3.5X100	<b>9008330000</b>
SDIS 0.6X3.5X100	<b>9008390000</b>
Wire-end ferrule	
H0,5/14S W	<b>9004590000</b>
H1,0/14S R	<b>9018560000</b>
H1,5/14S SW	<b>9025240000</b>
H2,5/14S BL	<b>1333100000</b>

### Ordering data

Solder pin length				
Colour	Orange			
Pitch	5.08 mm			
Pol.	L1	(inch)	Qty.	Order No.
2	5.08	0.200	180	<b>1982700000</b>
3	10.16	0.400	120	<b>1982710000</b>
4	15.24	0.600	90	<b>1982720000</b>
5	20.32	0.800	72	<b>1982730000</b>
6	25.40	1.000	60	<b>1982740000</b>
7	30.48	1.200	48	<b>1982750000</b>
8	35.56	1.400	42	<b>1982760000</b>
9	40.64	1.600	36	<b>1982770000</b>
10	45.72	1.800	36	<b>1982780000</b>
11	50.80	2.000	30	<b>1982790000</b>
12	55.88	2.200	30	<b>1982800000</b>
13	60.96	2.400	24	<b>1982810000</b>
14	66.04	2.600	24	<b>1982820000</b>
15	71.12	2.800	24	<b>1982830000</b>
16	76.20	3.000	18	<b>1982840000</b>
17	81.28	3.200	18	<b>1982850000</b>
18	86.36	3.400	18	<b>1982860000</b>
19	91.44	3.600	18	<b>1982870000</b>
20	96.52	3.800	18	<b>1982880000</b>

### Representative deratings curve

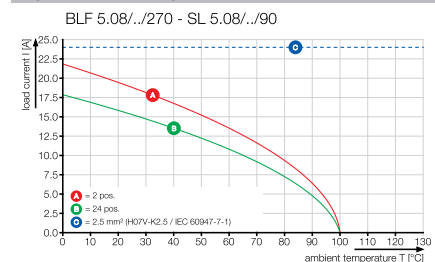

**BLF 5.08HC../270F**



Dimensioned drawing

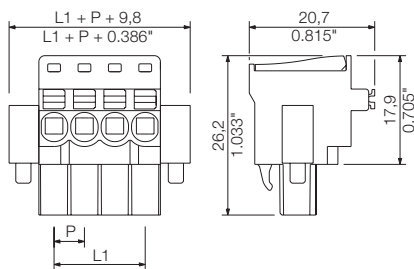

**Ordering data**

Solder pin length					
Colour					Orange
Pitch 5.08 mm					
Pol.	L1	(inch)	Qty.	Order No.	
2	5.08	0.200	90	1982890000	
3	10.16	0.400	72	1982900000	
4	15.24	0.600	60	1982910000	
5	20.32	0.800	48	1982920000	
6	25.40	1.000	42	1982930000	
7	30.48	1.200	36	1982940000	
8	35.56	1.400	36	1982950000	
9	40.64	1.600	30	1982960000	
10	45.72	1.800	30	1982970000	
11	50.80	2.000	24	1982980000	
12	55.88	2.200	24	1982990000	
13	60.96	2.400	24	1983000000	
14	66.04	2.600	18	1983010000	
15	71.12	2.800	18	1983020000	
16	76.20	3.000	18	1983030000	
17	81.28	3.200	18	1983040000	
18	86.36	3.400	18	1983050000	
19	91.44	3.600	12	1983060000	
20	96.52	3.800	12	1983070000	

**BLF 5.08HC../270LR**

with release latch



Dimensioned drawing

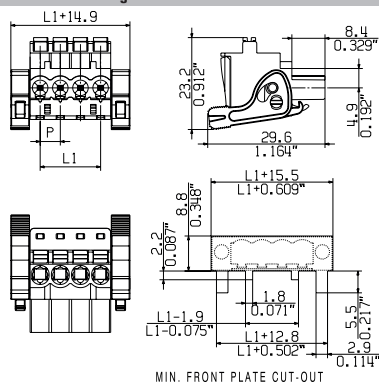

**Ordering data**

Solder pin length					
Colour					Orange
Pitch 5.08 mm					
Pol.	L1	(inch)	Qty.	Order No.	
2	5.08	0.200	90	1983080000	
3	10.16	0.400	72	1983090000	
4	15.24	0.600	60	1983100000	
5	20.32	0.800	48	1983110000	
6	25.40	1.000	42	1983120000	
7	30.48	1.200	36	1983130000	
8	35.56	1.400	36	1983140000	
9	40.64	1.600	30	1983150000	
10	45.72	1.800	30	1983160000	
11	50.80	2.000	24	1983170000	
12	55.88	2.200	24	1983180000	
13	60.96	2.400	24	1983190000	
14	66.04	2.600	18	1983200000	
15	71.12	2.800	18	1983210000	
16	76.20	3.000	18	1983220000	
17	81.28	3.200	18	1983230000	
18	86.36	3.400	18	1983240000	
19	91.44	3.600	12	1983250000	
20	96.52	3.800	12	1983260000	

**PUSH IN connection technology**

"PUSH IN" connection technology reduces the wiring efforts especially for solid wires and wires with ferrule to a minimum. These connectors are self-explanatory and enable tool-less handling. The contact element made of stainless steel ensures a vibration proof, maintenance free wire termination. The established principle "STEEL FOR THE FORCE, COPPER FOR THE CURRENT" by Weidmüller offers both, maximum conductor clamping forces, as well as minimum power loss at the same time.



**The 2-in-1 contact**

Every pluggable connector covers two different requirements: First, the wire termination and second, the connection between plug and pin header. Referring to the 5.0x pitch series, Weidmüller offers different wire connection technologies, but one platform contact for the male / female connection since years. This well-designed hybride platform contact ensures a constant quality on a very high level. Hybride means, that we combine metal material featuring different characteristics by welding, in order to divide the contact system into different function zones: Further to the high electric conductance, the current bar is characterized by its hardness, and the tulip contact by its excellent tension properties. The advantage: each function is supported by the most suitable material to reliably and constantly meet the different electrical and mechanical requirements. To put it in a nutshell: Instead of either ... or, it's even both - perfect for the current, and perfect for the force.



## Connectors in 5.08 mm pitch Series BL/SL 5.08

### BLDF 5.08/./180

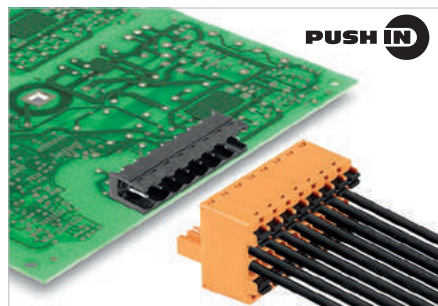

**PUSH IN**

Bus connector with two connections per pole with the time-saving "PUSH IN" connection system.

- The extremely short cross-connection allows you to safely loop through bus currents of up to 22 A.
- This permits an interruption-free decoupling of individual modules from the network.
- Solid wires and stranded wires with ferrules need only to be inserted and they are ready.
- An actuator must be used when connecting stranded wires with ferrules.
- Lock and release-lever: tool-less locking and gentle releasing of the connector reduces the mechanical stress on the solder joints.

### Technical data

In compliance with IEC 60664-1 / IEC 61984			
Clamping range, max.	mm <sup>2</sup>	0.13...3.31	
<b>Solid core H05(07) V-U</b>	<b>mm<sup>2</sup></b>	<b>0.2...2.5</b>	
Stranded H07 V-R			
Flexible H05(07) V-K	mm <sup>2</sup>	0.2...2.5	
Flexible with ferrule	mm <sup>2</sup>	0.25...2.5	
Ferrule with plastic collar	mm <sup>2</sup>	0.25...2.5	
Stripping length	mm	10	
Screwdriver blade	mm	0.6 x 3.5	
	According to norm	DIN 5264	
Tightening torque range			
<b>Rated current, max.</b>	<b>A</b>	<b>20.8</b>	<b>17.9</b>
At ambient temperature	20°C		40°C
For conductor cross-section	mm <sup>2</sup>	2.5	
Overvoltage category		III	III II
Pollution severity		3	2 2
<b>Rated voltage</b>	<b>V</b>	<b>250</b>	<b>320 400</b>
Rated impulse voltage	kV	4	4 4
<b>UL / CUL (Use Group)</b>		<b>B</b>	<b>C D</b>
<b>Rated voltage</b>	<b>V</b>	<b>300</b>	<b>300</b>
<b>Rated current</b>	<b>A</b>	<b>18.5</b>	<b>10</b>
<b>AWG conductor</b>	<b>AWG</b>	<b>12-26</b>	
<b>CSA (Use Group)</b>		<b>B</b>	<b>C D</b>
Rated voltage	V	300	300
Rated current	A	18.5	10
AWG conductor	AWG	12-26	
<b>General data</b>			
Type of insulation material		PBT	
UL 94 flammability rating		V-0	
Contact base material		CuSn	
Material of contact surface		tinned	
Pin dimensions = d	mm		
Solder eyelet Ø = D			
Solder eyelet Ø tolerance	mm		

### Product data

IEC: 400 V / 20.8 A / 0.2 - 2.5 mm<sup>2</sup>  
UL: 300 V / 18.5 A / AWG 12 - 26



For additional articles and information, refer to [catalog.weidmuller.com](http://catalog.weidmuller.com)

#### Note:

- Additional colours on request
- Gold-plated contact surfaces on request
- Rated current related to rated cross-section & min. No. of poles.
- Wire end ferrule without plastic collar to DIN 46228/1
- Wire end ferrule with plastic collar to DIN 46228/4
- P on drawing = pitch

### BLDF 5.08/./180



#### Dimensioned drawing

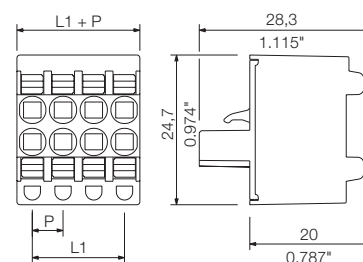

### Ordering data

Solder pin length				
Colour	Orange			
Pitch	5.08 mm		Qty.	Order No.
Pol.	L1	(inch)		
2	5.08	0.200	120	1001150000
3	10.16	0.400	80	1001160000
4	15.24	0.600	60	1001170000
5	20.32	0.800	48	1001180000
6	25.40	1.000	40	1001190000
7	30.48	1.200	32	1001200000
8	35.56	1.400	28	1001210000

### Accessories

Note: Refer to the Accessories chapter for additional accessories.

Coding	Order No.
BLZ/SL KO OR BX	1573010000
BLZ/SL KO BK BX	1545710000
Screwdriver	
SDS 0.6X3.5X100	9008330000
SDIS 0.6X3.5X100	9008390000
Wire-end ferrule	
H0,5/14S W	9004590000
H1,0/14S R	9018560000
H1,5/14S SW	9025240000
H2,5/14S BL	1333100000



**BLDF 5.08/./180F**



Dimensioned drawing

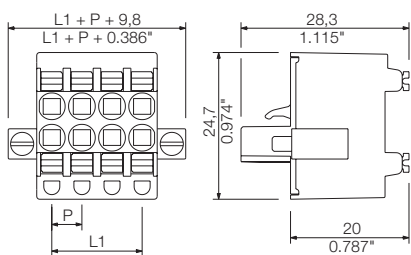

**Ordering data**

Solder pin length					
Colour					Orange
<b>Pitch 5.08 mm</b>					
Pol.	L1	(inch)	Qty.	Order No.	
2	5.08	0.200	60	1001220000	
3	10.16	0.400	48	1012060000	
4	15.24	0.600	40	1059420000	
5	20.32	0.800	32	1065080000	
6	25.40	1.000	28	1065090000	
7	30.48	1.200	24	1065110000	
8	35.56	1.400	24	1065120000	

**BLDF 5.08/./180LR**

with release latch



Dimensioned drawing

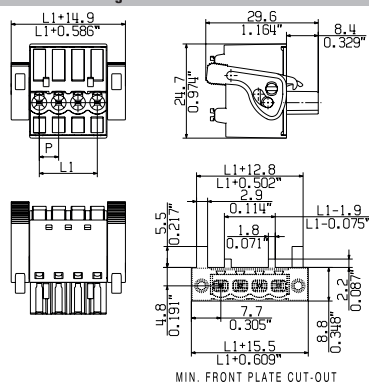

**Ordering data**

Solder pin length					
Colour					Orange
<b>Pitch 5.08 mm</b>					
Pol.	L1	(inch)	Qty.	Order No.	
2	5.08	0.200	60	1065130000	
3	10.16	0.400	48	1065140000	
4	15.24	0.600	40	1065150000	
5	20.32	0.800	32	1065160000	
6	25.40	1.000	28	1065170000	
7	30.48	1.200	24	1065180000	
8	35.56	1.400	24	1065190000	

**PUSH IN connection technology**

"PUSH IN" connection technology reduces the wiring efforts especially for solid wires and wires with ferrule to a minimum. These connectors are self-explanatory and enable tool-less handling. The contact element made of stainless steel ensures a vibration proof, maintenance free wire termination. The established principle "STEEL FOR THE FORCE, COPPER FOR THE CURRENT" by Weidmüller offers both, maximum conductor clamping forces, as well as minimum power loss at the same time.



**The 2-in-1 contact**

Every pluggable connector covers two contact points and thus must meet two different requirements: First, the wire termination and second, the connection between plug and pin header. Referring to the 5.0x pitch series, Weidmüller offers different wire connection technologies, but one platform contact for the male / female connection since years. This well-designed hybrid platform contact ensures a constant quality on a very high level. Hybride means, that we combine metal material featuring different characteristics by welding, in order to divide the contact system into different function zones: Further to the high electric conductance, the current bar is characterized by its hardness, and the tulip contact by its excellent tension properties. The advantage: each function is supported by the most suitable material to reliably and constantly meet the different electrical and mechanical requirements. To put it in a nutshell: Instead of either ... or, it's even both - perfect for the current, and perfect for the force.



## Connectors in 5.08 mm pitch Series BL/SL 5.08

### BLC 5.08/./180

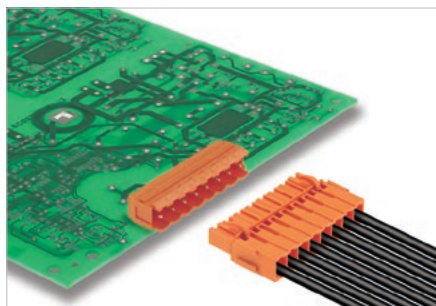

The female plugs with crimp connection can be used for automatically pre-assembled cable harnesses. This results in significant cost savings.

- The contacts are optimised for crimping machines (factory wiring).
- Contacts can also be connected with manual tools (field wiring).
- High component density because of very low height
- Large wire clamping range: 0.22-2.5 mm<sup>2</sup>
- Contacts can be delivered loose in bulk, or in tape-packaged strips.

### Product data

IEC: 400 V / 21 A  
UL: 300 V / 10 A / AWG 26 - 14



For additional articles and information, refer to [catalog.weidmueller.com](http://catalog.weidmueller.com)

#### Note:

- Additional colours on request
- Rated current related to rated cross-section & min. No. of poles.
- Rated cross-section depends on crimp contact used.
- P on drawing = pitch
- Rated data refer only to the component itself. Clearance and creepage distances to other components are to be designed in accordance with the relevant application standards.

### BLC 5.08/./180R



#### Dimensioned drawing

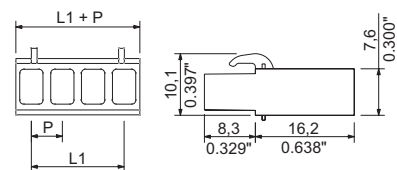

### Technical data

In compliance with IEC 60664-1 / IEC 61984			
Clamping range, max.	mm <sup>2</sup>	0.22...2.5	
<b>Solid core H05(07) V-U</b>			
Stranded H07 V-R			
Flexible H05(07) V-K	mm <sup>2</sup>	0.5...2.5	
Flexible with ferrule			
Ferrule with plastic collar			
Stripping length	mm	5	
Screwdriver blade	mm		
According to norm			
Tightening torque range			
<b>Rated current, max.</b>	<b>A</b>	<b>21</b>	<b>18</b>
At ambient temperature		20°C	40°C
For conductor cross-section	mm <sup>2</sup>	2.5	
Overvoltage category		III	II
Pollution severity		3	2
<b>Rated voltage</b>	<b>V</b>	<b>250</b>	<b>320</b>
Rated impulse voltage	kV	4	4
<b>UL / CUL (Use Group)</b>		<b>B</b>	<b>C</b>
<b>Rated voltage</b>	<b>V</b>	<b>300</b>	<b>300</b>
<b>Rated current</b>	<b>A</b>	<b>10</b>	<b>10</b>
<b>AWG conductor</b>	<b>AWG</b>	<b>26-14</b>	
<b>CSA (Use Group)</b>		<b>B</b>	<b>C</b>
Rated voltage	V	300	300
Rated current	A	10	10
AWG conductor	AWG	26-14	
<b>General data</b>			
Type of insulation material		PBT GF	
UL 94 flammability rating		V-0	
Contact base material		Copper alloy	
Material of contact surface			
Pin dimensions = d	mm		
Solder eyelet Ø = D	mm		
Solder eyelet Ø tolerance	mm		

### Accessories

Note: Refer to the Accessories chapter for additional accessories.

Coding	Order No.
BLZ/SL KO OR BX	<b>1573010000</b>
BLZ/SL KO BK BX	<b>1545710000</b>
DFFC 0.22-0.35 SN 3000	<b>1604230000</b>
DFFC 0.22-0.35 SN E	<b>1604250000</b>
DFFC 0.5-1.0 SN 3000	<b>1480000000</b>
DFFC 0.5-1.0 SN E	<b>1567060000</b>
DFFC 1.5-2.5 SN 2500	<b>1480100000</b>
DFFC 1.5-2.5 SN E	<b>1567070000</b>
<b>Crimping tool</b>	
HTF DFF	<b>9014140000</b>

### Ordering data

Solder pin length					
Colour					Orange
Pitch	5.08 mm		Qty.	Order No.	
Pol.	L1	(inch)			
2	5.08	0.200	100	<b>1610490000</b>	
3	10.16	0.400	100	<b>1610500000</b>	
4	15.24	0.600	100	<b>1610510000</b>	
5	20.32	0.800	50	<b>1610520000</b>	
6	25.40	1.000	50	<b>1610530000</b>	
7	30.48	1.200	50	<b>1610540000</b>	
8	35.56	1.400	50	<b>1610550000</b>	
9	40.64	1.600	50	<b>1610560000</b>	
10	45.72	1.800	50	<b>1610570000</b>	
11	50.80	2.000	50	<b>1610580000</b>	
12	55.88	2.200	50	<b>1610590000</b>	
13	60.96	2.400	50	<b>1610600000</b>	
14	66.04	2.600	50	<b>1610610000</b>	
15	71.12	2.800	50	<b>1610620000</b>	
16	76.20	3.000	50	<b>1610630000</b>	

### Representative deratings curve

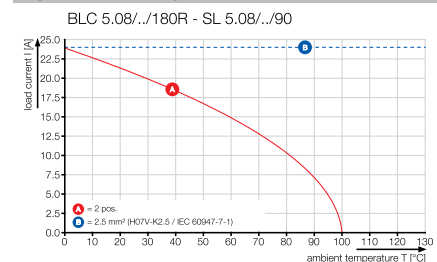

BLC 5.08/.../180BR

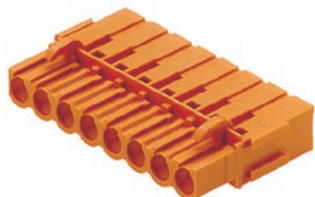

Dimensioned drawing

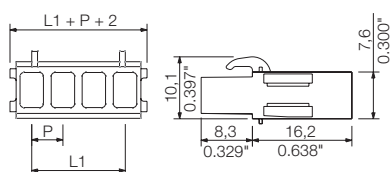

Ordering data

Solder pin length				
Colour				Orange
Pitch 5.08 mm				
Pol.	L1	(inch)	Qty.	Order No.
2	5.08	0.200	100	1649370000
3	10.16	0.400	100	1649380000
4	15.24	0.600	100	1649390000
5	20.32	0.800	50	1649400000
6	25.40	1.000	50	1649410000
7	30.48	1.200	50	1649420000
8	35.56	1.400	50	1649430000
9	40.64	1.600	50	1649440000
10	45.72	1.800	50	1649450000
11	50.80	2.000	50	1649460000
12	55.88	2.200	50	1649470000
13	60.96	2.400	50	1649480000
14	66.04	2.600	50	1649490000
15	71.12	2.800	50	1649500000
16	76.20	3.000	50	1649510000



## Connectors in 5.08 mm pitch Series BL/SL 5.08

### BLL 5.08/./90

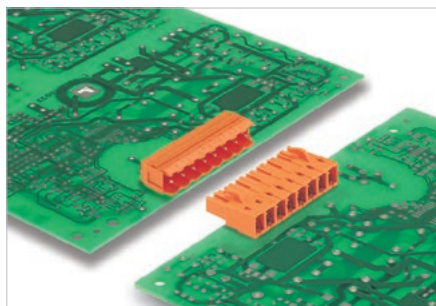

Female headers for mounting on the circuit board; with 90° wire outlet, optimised for the wave soldering process.

- BLL 5.08 & SL 5.08 for board-to-board connections (e.g., backplanes)
- BLL 5.08 & SLS / SLT 5.08 for board-to-wire applications (e.g., power supply for actuators)
- Available with a screw flange (F).

### Product data

IEC: 400 V / 23 A  
UL: 300 V / 15 A



For additional articles and information, refer to [catalog.weidmueller.com](http://catalog.weidmueller.com)

#### Note:

- Additional colours on request
- Gold-plated contact surfaces on request
- Rated current related to rated cross-section & min. No. of poles.
- P on drawing = pitch
- Rated data refer only to the component itself. Clearance and creepage distances to other components are to be designed in accordance with the relevant application standards.

### BLL 5.08/./90



#### Dimensioned drawing

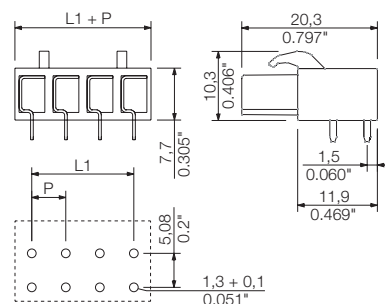

## G

### Technical data

#### In compliance with IEC 60664-1 / IEC 61984

Clamping range, max.			
<b>Solid core H05(07) V-U</b>			
Stranded H07 V-R			
Flexible H05(07) V-K			
Flexible with ferrule			
Ferrule with plastic collar			
Stripping length			
Screwdriver blade	mm		
According to norm			
Tightening torque range			
<b>Rated current, max.</b>	<b>A</b>	<b>23</b>	<b>20</b>
At ambient temperature		20°C	40°C
For conductor cross-section			
Overtoltage category		III	III II
Pollution severity		3	2 2
<b>Rated voltage</b>	<b>V</b>	<b>250</b>	<b>320 400</b>
Rated impulse voltage	kV	4	4 4
<b>UL / CUL (Use Group)</b>		<b>B</b>	<b>C D</b>
<b>Rated voltage</b>	<b>V</b>	<b>300</b>	<b>300</b>
<b>Rated current</b>	<b>A</b>	<b>15</b>	<b>10</b>
<b>AWG conductor</b>	<b>AWG</b>		-
<b>CSA (Use Group)</b>		<b>B</b>	<b>C D</b>
Rated voltage	V	300	300
Rated current	A	15	10
AWG conductor	AWG		-
<b>General data</b>			
Type of insulation material		PBT GF	
UL 94 flammability rating		V-0	
Contact base material		Copper alloy	
Material of contact surface		tinned	
Pin dimensions = d	mm	0.4 x 1.00	
Solder eyelet Ø = D	mm	1.3	
Solder eyelet Ø tolerance	mm	+ 0,1	

### Accessories

Note: Refer to the Accessories chapter for additional accessories.

Coding	Order No.
BLZ/SL KO OR BX	<b>1573010000</b>
BLZ/SL KO BK BX	<b>1545710000</b>
<b>Mounting block</b>	
SLA BB11R OR	<b>1604120000</b>
SLA BB11R SW	<b>1692340000</b>

### Ordering data

Solder pin length		3.2 mm		
Colour		Orange		
Pitch	5.08 mm			
Pol.	L1	(inch)	Qty.	Order No.
2	5.08	0.200	180	<b>1622940000</b>
3	10.16	0.400	120	<b>1622950000</b>
4	15.24	0.600	90	<b>1622960000</b>
5	20.32	0.800	72	<b>1622970000</b>
6	25.40	1.000	60	<b>1622980000</b>
7	30.48	1.200	48	<b>1622990000</b>
8	35.56	1.400	42	<b>1623000000</b>
9	40.64	1.600	36	<b>1623010000</b>
10	45.72	1.800	36	<b>1623020000</b>
11	50.80	2.000	30	<b>1623030000</b>
12	55.88	2.200	30	<b>1623040000</b>
13	60.96	2.400	24	<b>1648420000</b>
14	66.04	2.600	24	<b>1648430000</b>
15	71.12	2.800	24	<b>1648440000</b>
16	76.20	3.000	18	<b>1648450000</b>
17	81.28	3.200	18	<b>1648460000</b>
18	86.36	3.400	18	<b>1648470000</b>
19	91.44	3.600	18	<b>1648480000</b>
20	96.52	3.800	18	<b>1648490000</b>
21	101.60	4.000	12	<b>1648500000</b>
22	106.68	4.200	12	<b>1648510000</b>
23	111.76	4.400	12	<b>1648520000</b>
24	116.84	4.600	12	<b>1648530000</b>

5.08

90°

**BLL 5.08/./90FI**



Dimensioned drawing

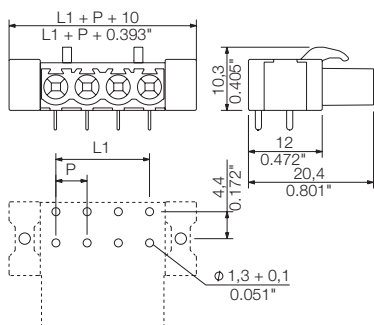

**Ordering data**

Solder pin length		3.2 mm		
Colour		Orange		
Pitch		5.08 mm		
Pol.	L1	(inch)	Qty.	Order No.
2	5.08	0.200	90	1843750000
3	10.16	0.400	72	1843760000
4	15.24	0.600	60	1843770000
5	20.32	0.800	48	1843780000
6	25.40	1.000	42	1843790000
7	30.48	1.200	36	1843800000
8	35.56	1.400	36	1843810000
9	40.64	1.600	30	1843820000
10	45.72	1.800	30	1843830000
11	50.80	2.000	24	1843840000
12	55.88	2.200	24	1843850000
13	60.96	2.400	24	1843860000
14	66.04	2.600	18	1843870000
15	71.12	2.800	18	1843880000
16	76.20	3.000	18	1843890000
17	81.28	3.200	18	1843900000
18	86.36	3.400	18	1843910000
19	91.44	3.600	12	1843920000
20	96.52	3.800	12	1843930000
21	101.60	4.000	12	1843940000
22	106.68	4.200	12	1843950000
23	111.76	4.400	12	1843960000
24	116.84	4.600	12	1843970000



## Connectors in 5.08 mm pitch Series BL/SL 5.08

### BLL 5.08/./180

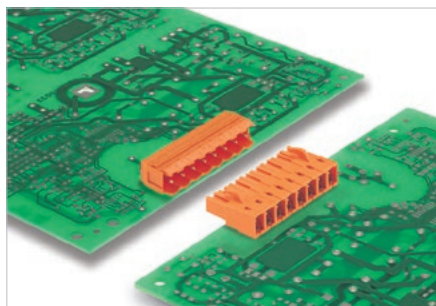

Female headers for mounting on the circuit board; with straight wire outlet, optimised for the wave soldering process.

- BLL 5.08 & SL 5.08 for board-to-board connections (e.g., backplanes)
- BLL 5.08 & SLS / SLT 5.08 for board-to-wire applications (e.g., power supply for actuators)

### Product data

IEC: 400 V / 23 A  
UL: 300 V / 15 A



For additional articles and information, refer to [catalog.weidmuller.com](http://catalog.weidmuller.com)

#### Note:

- Additional colours on request
- Gold-plated contact surfaces on request
- Rated current related to rated cross-section & min. No. of poles.
- P on drawing = pitch
- Rated data refer only to the component itself. Clearance and creepage distances to other components are to be designed in accordance with the relevant application standards.

### BLL 5.08/./180



#### Dimensioned drawing

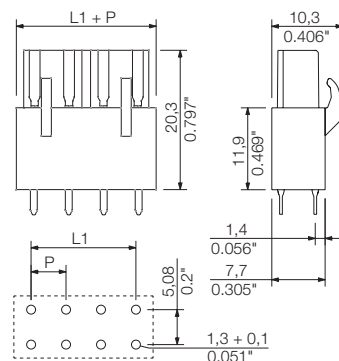

### Ordering data

Solder pin length		3.2 mm		
Colour		Orange		
Pitch		5.08 mm		
Pol.	L1	(inch)	Qty.	Order No.
2	5.08	0.200	180	1630710000
3	10.16	0.400	120	1630720000
4	15.24	0.600	90	1630730000
5	20.32	0.800	72	1630740000
6	25.40	1.000	60	1630750000
7	30.48	1.200	48	1630760000
8	35.56	1.400	42	1630770000
9	40.64	1.600	36	1630780000
10	45.72	1.800	36	1630790000
11	50.80	2.000	30	1630800000
12	55.88	2.200	30	1630810000
13	60.96	2.400	24	1648900000
14	66.04	2.600	24	1648910000
15	71.12	2.800	24	1648920000
16	76.20	3.000	18	1648930000
17	81.28	3.200	18	1648940000
18	86.36	3.400	18	1648950000
19	91.44	3.600	18	1648960000
20	96.52	3.800	18	1648970000
21	101.60	4.000	12	1648980000
22	106.68	4.200	12	1648990000
23	111.76	4.400	12	1649000000
24	116.84	4.600	12	1649010000

### Technical data

#### In compliance with IEC 60664-1 / IEC 61984

Clamping range, max.				
<b>Solid core H05(07) V-U</b>				
Stranded H07 V-R				
Flexible H05(07) V-K				
Flexible with ferrule				
Ferrule with plastic collar				
Stripping length				
Screwdriver blade	mm			
According to norm				
Tightening torque range				
<b>Rated current, max.</b>	<b>A</b>	<b>23</b>	<b>20</b>	
At ambient temperature		20°C	40°C	
For conductor cross-section				
Overvoltage category		III	III	II
Pollution severity		3	2	2
<b>Rated voltage</b>	<b>V</b>	<b>250</b>	<b>320</b>	<b>400</b>
Rated impulse voltage	kV	4	4	4
<b>UL / CUL (Use Group)</b>	<b>B</b>	<b>C</b>	<b>D</b>	
<b>Rated voltage</b>	<b>V</b>	<b>300</b>	<b>300</b>	
<b>Rated current</b>	<b>A</b>	<b>15</b>	<b>10</b>	
<b>AWG conductor</b>	<b>AWG</b>			
<b>CSA (Use Group)</b>	<b>B</b>	<b>C</b>	<b>D</b>	
Rated voltage	V	300	300	
Rated current	A	15	10	
AWG conductor	AWG			
<b>General data</b>				
Type of insulation material		PBT GF		
UL 94 flammability rating		V-0		
Contact base material		Copper alloy		
Material of contact surface		tinned		
Pin dimensions = d	mm	0.4 x 1.00		
Solder eyelet Ø = D	mm	1.3		
Solder eyelet Ø tolerance	mm	+ 0,1		

### Accessories

Note: Refer to the Accessories chapter for additional accessories.

Coding	Order No.
BLZ/SL KO OR BX	1573010000
BLZ/SL KO BK BX	1545710000
Mounting block	
SLA BB11R OR	1604120000
SLA BB11R SW	1692340000

BLL 5.08/./180B



Dimensioned drawing

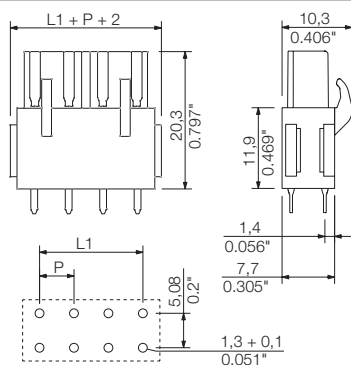

Ordering data

Solder pin length		3.2 mm		
Colour		Orange		
Pitch		5.08 mm		
Pol.	L1	(inch)	Qty.	Order No.
2	5.08	0.200	204	1682730000
3	10.16	0.400	108	1682740000
4	15.24	0.600	78	1682750000
5	20.32	0.800	66	1682760000
6	25.40	1.000	54	1682770000
7	30.48	1.200	48	1682780000
8	35.56	1.400	42	1682790000
9	40.64	1.600	36	1682800000
10	45.72	1.800	30	1682810000
11	50.80	2.000	30	1682820000
12	55.88	2.200	24	1682830000
13	60.96	2.400	24	1682840000
14	66.04	2.600	24	1682850000
15	71.12	2.800	24	1682860000
16	76.20	3.000	18	1682870000
17	81.28	3.200	18	1682880000
18	86.36	3.400	18	1682890000
19	91.44	3.600	18	1682900000
20	96.52	3.800	18	1682910000
21	101.60	4.000	12	1682920000
22	106.68	4.200	12	1682930000
23	111.76	4.400	12	1682940000
24	116.84	4.600	12	1682950000



G



# OMNIMATE® Signal PCB connectors Series RSV

---

<b>OMNIMATE® Signal PCB connectors Series RSV</b>	Connectors in 5.00 mm pitch Series RSV		
		Explanation	H.2
		Quick selection	H.4
		Product selection	H.6

---

## RSV 1.6 CB / CS

### Highest flexibility with the highest density

A space miracle for the PCB and the field wiring permits up to 36 contacts to be inserted in one operation. The crimp contacts ensure that the contacts can be quickly and flexibly assembled – their plastic cases automatically snap together when joined. This system can be used for many signalling purposes: whether it is soldered on to the circuit board, mounted on the rail using a mounting-rail foot, or built in to the front of the device. This product line also includes versatile coding elements, a choice between tin or gold surfaces, and snap-on plug hoods.

#### Versatile system-based wiring

Very versatile assembly: different functions can be combined with different wire cross-sections (from 0.14 mm<sup>2</sup> to 2.5 mm<sup>2</sup>). Tin-plated or gold-plated contact surfaces can be custom selected from pole to pole based on your application requirements. This delivers clear cost savings. Higher voltages may require larger clearance gaps between the contacts. This problem can be solved without changing to a different type of connector by simply occupying every second pole.

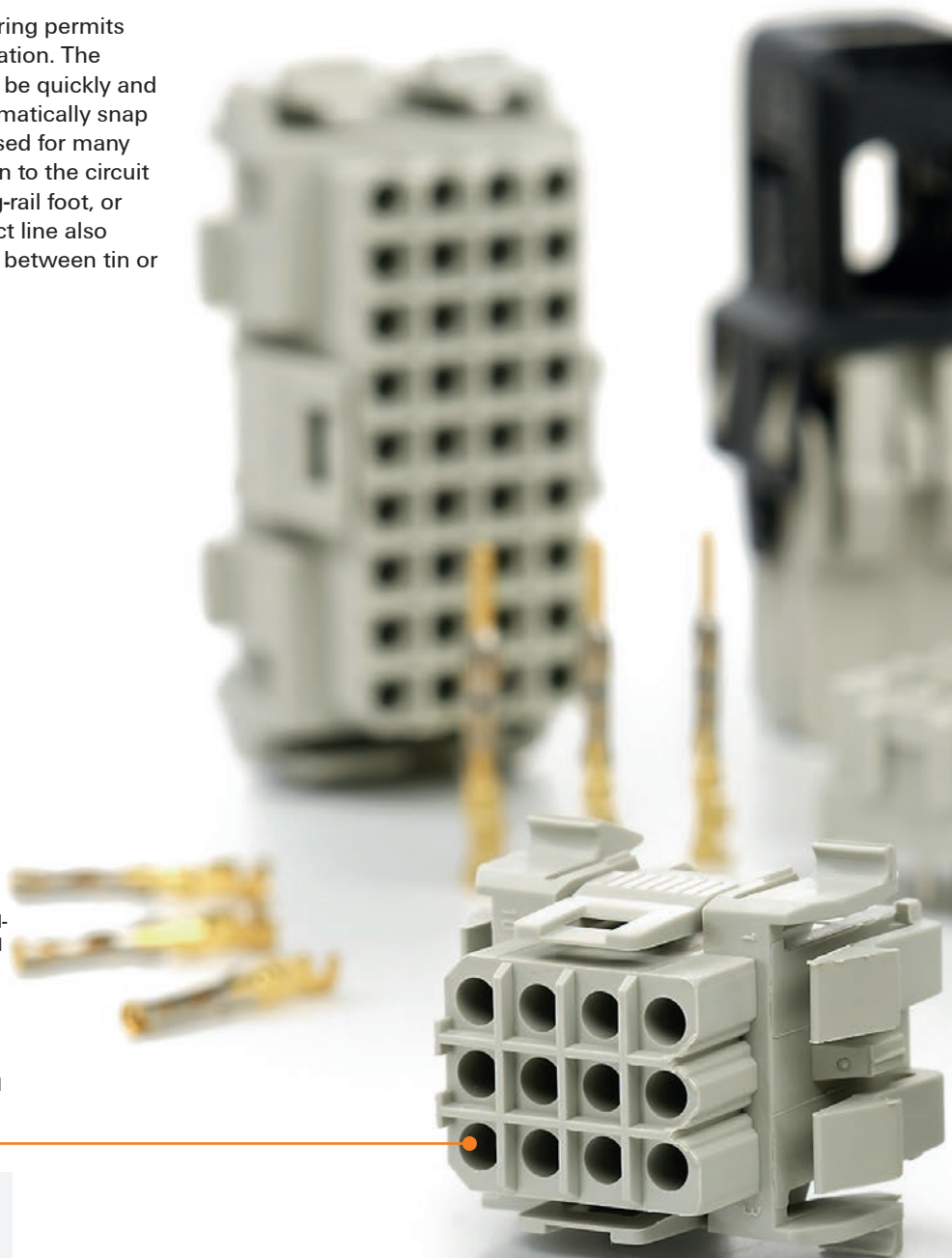

**Also with gold contacts to meet application requirements**

Gold-plated contacts are the best solution for very low currents or voltages, such as those used with measurements. Gold surfaces are a reliable safeguard against friction corrosion caused by long-term vibrations. Compared to tin contacts which are rated for 100 plugging cycles, gold-plated contacts have an increased rating of 500 plugging cycles.

H

**Highest component assembly density for 5-mm pitch**

Every square mm is crucial on the circuit board. The RSV permit 36 poles to fit in a 5-mm pitch on a 40 mm x 29 mm surface.

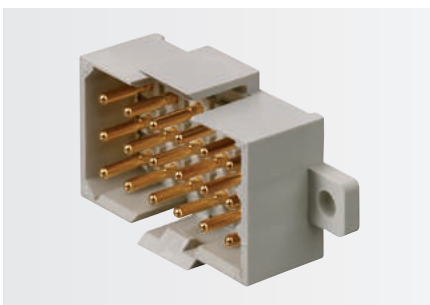

<http://www.OMNIMATE.net>

○ = Wire-to-Board	
● = Board-to-Board	
● = Wire-to-Wire	
● = Board-to-Wire	

### Series RSV



						Levels
		Type			Contact surface	IEC / UL
				Flange options		
Female header	Crimp		RSV1.6 CB..	Tin / Gold	(G)	IEC: 630 V/17 A UL: 600 V/10 A/AWG 26 - 12
			RSV1.6 LB.. SN	Tin	(G)/F	IEC: 500 V/14 A UL: 300 V/10 A
	Solder connection		RSV1.6 LB.. AU	Gold	(G)/F	IEC: 500 V/14 A UL: 300 V/10 A

(G)\* = Closed (without flange)  
F = Flange

\* = not included in the article description

Male header	Male plug
 <b>Solder connection</b>	 <b>Crimp</b>



1		1
RSV1.6 LS.. SN	RSV1.6 LS.. AU	RSV1.6 CS..
Tin	Gold	Tin / Gold
(G)/F	(G)/F	(G)
IEC: 500 V/14 A UL: 300 V/10 A	IEC: 500 V/14 A UL: 300 V/10 A	IEC: 630 V/17 A UL: 600 V/10 A/AWG 26 - 12
○	○	●
●		●
	●	●



RSV1.6 LS..

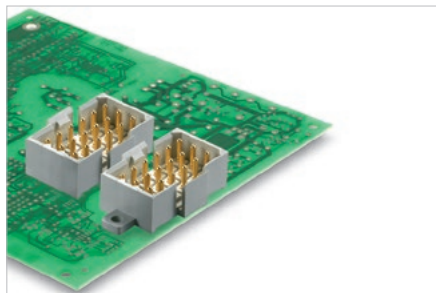

Rectangular plug-in male connector with solder contacts for PCB applications. High connection density achieved by using several rows and crimp contacts in the mating connector. The plug-in connectors can be coded and locked to the mating connector. Supplied in cardboard box.

Product data

IEC: 500 V / 14 A  
UL: 300 V / 10 A



For additional articles and information, refer to [catalog.weidmueller.com](http://catalog.weidmueller.com)

Note:

- Additional colours on request
- Rated current related to rated cross-section & min. No. of poles.
- Spacing between rows: see hole layout
- Rated data refer only to the component itself. Clearance and creepage distances to other components are to be designed in accordance with the relevant application standards.

RSV1.6 LS.. SN

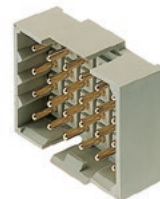

Dimensioned drawing

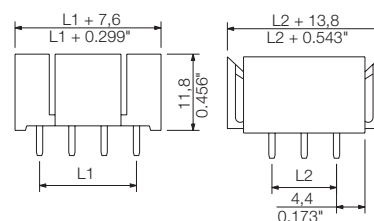

Technical data

In compliance with IEC 60664-1 / IEC 61984

Clamping range, max.			
<b>Solid core H05(07) V-U</b>			
Stranded H07 V-R			
Flexible H05(07) V-K			
Flexible with ferrule			
Ferrule with plastic collar			
Stripping length			
Screwdriver blade	mm		
According to norm			
Tightening torque range			
<b>Rated current, max.</b>	<b>A</b>	<b>14</b>	<b>12</b>
At ambient temperature		20°C	40°C
For conductor cross-section			
Overvoltage category		III	III II
Pollution severity		3	2 2
<b>Rated voltage</b>	<b>V</b>	<b>250</b>	<b>320 500</b>
Rated impulse voltage	kV	4	2.5 2.5
<b>UL / CUL (Use Group)</b>		<b>B</b>	<b>C D</b>
<b>Rated voltage</b>			
<b>Rated current</b>			
<b>AWG conductor</b>	<b>AWG</b>	-	
<b>CSA (Use Group)</b>		<b>B</b>	<b>C D</b>
Rated voltage		300	
Rated current		13	
AWG conductor	AWG	-	
<b>General data</b>			
Type of insulation material		Wemid (PA)	
UL 94 flammability rating		V-0	
Contact base material		Copper alloy	
Material of contact surface		tinned	
Pin dimensions = d	mm	0.97	
Solder eyelet Ø = D	mm	1.3	
Solder eyelet Ø tolerance	mm	+ 0,1	

Accessories

Note: Refer to the Accessories chapter for additional accessories.

Coding		Order No.
●	RSV1,6 KO	1567430000

Ordering data

<b>Solder pin length</b>	3.2 mm			
<b>Colour</b>	Pebble grey			
<b>Pitch</b>	5.00 mm			
Pol.	L1	(inch)	Qty.	Order No.
4	5.00	0.197	100	1440500000
6	10.00	0.394	50	1441500000
9	10.00	0.394	50	1442500000
12	15.00	0.591	25	1443500000
18	25.00	0.984	25	1444500000
24	25.00	0.984	20	1445500000
36	40.00	1.575	10	1446500000

Representative deratings curve

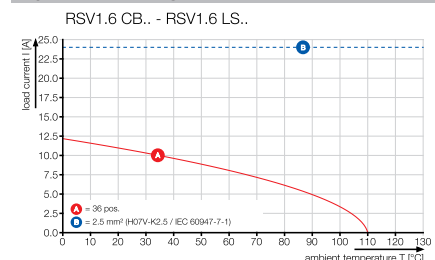

RSV1.6 LSF.. SN

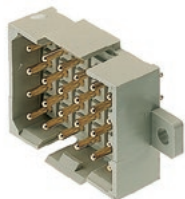

Dimensioned drawing

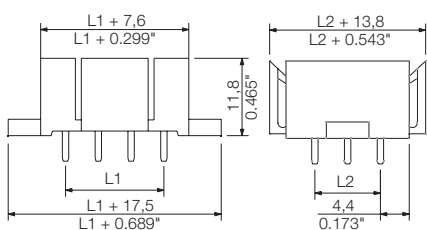

Ordering data

Solder pin length		3.2 mm	
Colour		Pebble grey	
Pitch		5.00 mm	
Pol.	L1	(inch)	Qty. Order No.
4	5.00	0.197	100 1440900000
6	10.00	0.394	50 1441900000
9	10.00	0.394	50 1442900000
12	15.00	0.591	25 1443900000
18	25.00	0.984	25 1444900000
24	25.00	0.984	20 1445900000
36	40.00	1.575	10 1446900000

Drilling diagrams

4-pole

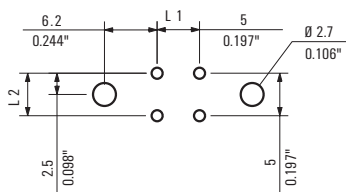

6-pole

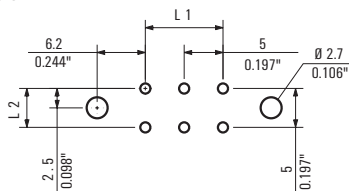

9-pole

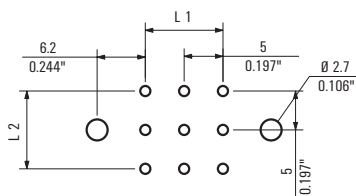

12-pole

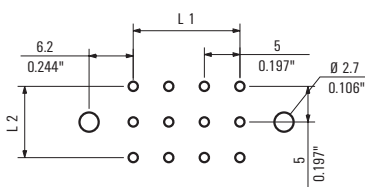

18-pole

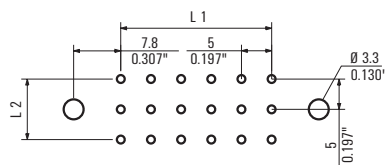

24-pole

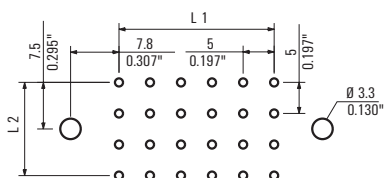

36-pole

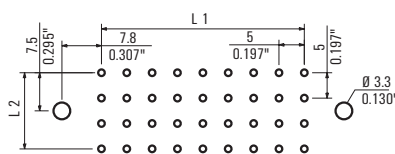

Additional deratings curves

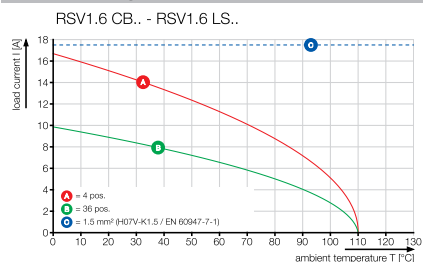

## Connectors in 5.00 mm pitch Series RSV

### RSV1.6 LB..

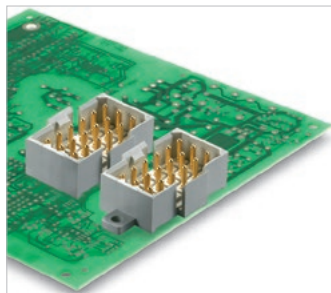

Rectangular plug-in female connector with solder contacts for PCB applications. High connection density achieved by using several rows and crimp contacts in the mating connector. The plug-in connectors can be coded and locked to the mating connector. Supplied in cardboard box.

### Technical data

#### In compliance with IEC 60664-1 / IEC 61984

Clamping range, max.			
<b>Solid core H05(07) V-U</b>			
Stranded H07 V-R			
Flexible H05(07) V-K			
Flexible with ferrule			
Ferrule with plastic collar			
Stripping length			
Screwdriver blade	mm		
According to norm			
Tightening torque range			
<b>Rated current, max.</b>	<b>A</b>	<b>14</b>	<b>12</b>
At ambient temperature		20°C	40°C
For conductor cross-section			
Overvoltage category		III	III II
Pollution severity		3	2 2
<b>Rated voltage</b>	<b>V</b>	<b>250</b>	<b>320 500</b>
Rated impulse voltage	kV	4	2.5 2.5
<b>UL / CUL (Use Group)</b>	<b>B</b>	<b>C</b>	<b>D</b>
<b>Rated voltage</b>	<b>300</b>		
<b>Rated current</b>	<b>10</b>		
<b>AWG conductor</b>	<b>AWG</b>	<b>-</b>	
<b>CSA (Use Group)</b>	<b>B</b>	<b>C</b>	<b>D</b>
Rated voltage	300		
Rated current	13		
AWG conductor	AWG	-	
<b>General data</b>			
Type of insulation material	Wemid (PA)		
UL 94 flammability rating	V-0		
Contact base material	Copper alloy		
Material of contact surface	tinned		
Pin dimensions = d	mm	0.97	
Solder eyelet Ø = D	mm	1.3	
Solder eyelet Ø tolerance	mm	+ 0,1	

### Product data

IEC: 500 V / 14 A  
UL: 300 V / 10 A



For additional articles and information, refer to [catalog.weidmueller.com](http://catalog.weidmueller.com)

#### Note:

- Additional colours on request
- Rated current related to rated cross-section & min. No. of poles.
- Spacing between rows: see hole layout
- Rated data refer only to the component itself. Clearance and creepage distances to other components are to be designed in accordance with the relevant application standards.

### RSV1.6 LB.. SN



#### Dimensioned drawing

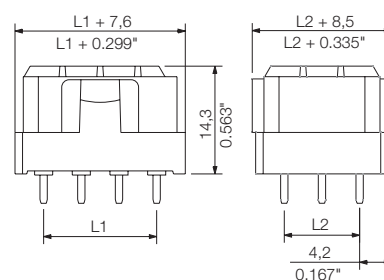

### Accessories

Note: Refer to the Accessories chapter for additional accessories.

Coding		Order No.
●	RSV1,6 KO	1567430000

### Ordering data

<b>Solder pin length</b>		3.2 mm	
<b>Colour</b>		Pebble grey	
<b>Pitch</b>	5.00 mm		
Pol.	L1	(inch)	Qty. Order No.
4	5.00	0.197	100 1440300000
6	10.00	0.394	50 1441300000
9	10.00	0.394	50 1442300000
12	15.00	0.591	25 1443300000
18	25.00	0.984	25 1444300000
24	25.00	0.984	20 1445300000
36	40.00	1.575	10 1446300000

### Representative deratings curve

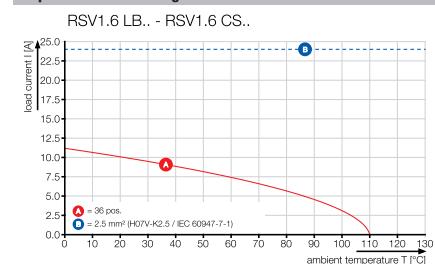



RSV1.6 LBF.. SN



Dimensioned drawing

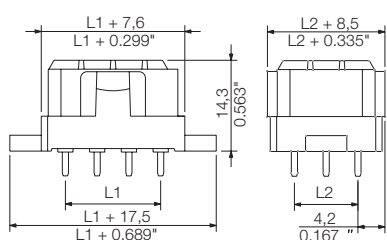

Ordering data

Solder pin length		3.2 mm	
Colour		Pebble grey	
Pitch		5.00 mm	
Pol.	L1	(inch)	Qty. Order No.
4	5.00	0.197	100 1440700000
6	10.00	0.394	50 1441700000
9	10.00	0.394	50 1442700000
12	15.00	0.591	25 1443700000
18	25.00	0.984	25 1444700000
24	25.00	0.984	20 1445700000
36	40.00	1.575	10 1446700000

Drilling diagrams

4-pole

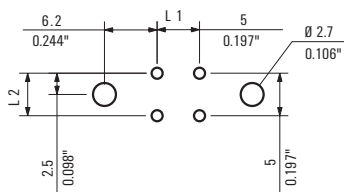

6-pole

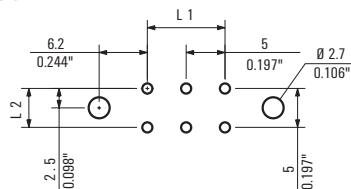

9-pole

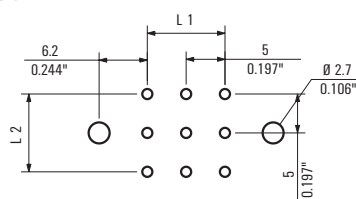

12-pole

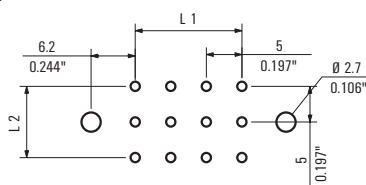

18-pole

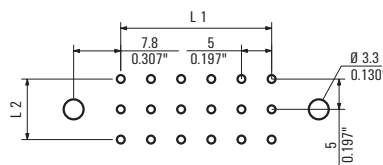

24-pole

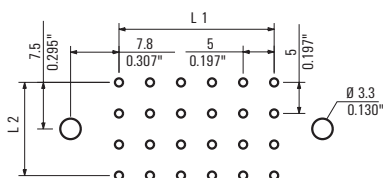

36-pole

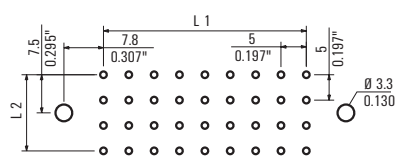

Additional deratings curves

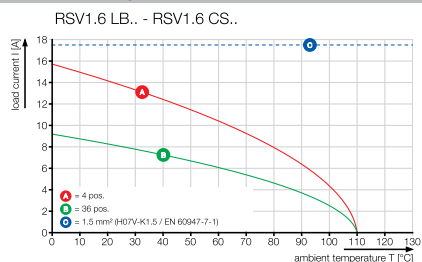

RSV1.6 LS.. AU

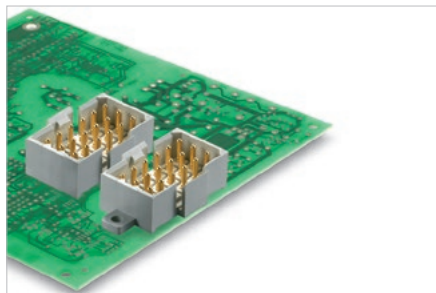

Rectangular plug-in male connector with solder contacts for PCB applications. High connection density achieved by using several rows and crimp contacts in the mating connector. The plug-in connectors can be coded and locked to the mating connector. Supplied in cardboard box.

Product data

IEC: 500 V / 14 A  
UL: 300 V / 10 A



For additional articles and information, refer to [catalog.weidmueller.com](http://catalog.weidmueller.com)

Note:

- Additional colours on request
- Rated current related to rated cross-section & min. No. of poles.
- Spacing between rows: see hole layout
- Rated data refer only to the component itself. Clearance and creepage distances to other components are to be designed in accordance with the relevant application standards.

RSV1.6 LS.. AU

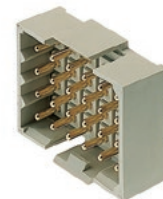

Dimensioned drawing

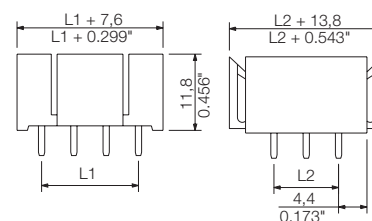

Technical data

In compliance with IEC 60664-1 / IEC 61984

Clamping range, max.			
<b>Solid core H05(07) V-U</b>			
Stranded H07 V-R			
Flexible H05(07) V-K			
Flexible with ferrule			
Ferrule with plastic collar			
Stripping length			
Screwdriver blade	mm		
According to norm			
Tightening torque range			
<b>Rated current, max.</b>	<b>A</b>	<b>14</b>	<b>12</b>
At ambient temperature		20°C	40°C
For conductor cross-section			
Overvoltage category		III	III II
Pollution severity		3	2 2
<b>Rated voltage</b>	<b>V</b>	<b>250</b>	<b>320 500</b>
Rated impulse voltage	kV	4	2.5 2.5
<b>UL / CUL (Use Group)</b>		<b>B</b>	<b>C D</b>
<b>Rated voltage</b>			
<b>Rated current</b>			
<b>AWG conductor</b>	<b>AWG</b>	-	
<b>CSA (Use Group)</b>		<b>B</b>	<b>C D</b>
Rated voltage		300	
Rated current		13	
AWG conductor	AWG	-	
<b>General data</b>			
Type of insulation material		Wemid (PA)	
UL 94 flammability rating		V-0	
Contact base material		Copper alloy	
Material of contact surface		Gold-plated	
Pin dimensions = d	mm	0.97	
Solder eyelet Ø = D	mm	1.3	
Solder eyelet Ø tolerance	mm	+ 0,1	

Accessories

Note: Refer to the Accessories chapter for additional accessories.

Coding		Order No.
●	RSV1,6 KO	1567430000

Ordering data

<b>Solder pin length</b>	3.2 mm			
<b>Colour</b>	Pebble grey			
<b>Pitch</b>	5.00 mm			
Pol.	L1	(inch)	Qty.	Order No.
4	5.00	0.197	100	1440400000
6	10.00	0.394	50	1441400000
9	10.00	0.394	50	1442400000
12	15.00	0.591	25	1443400000
18	25.00	0.984	25	1444400000
24	25.00	0.984	20	1445400000
36	40.00	1.575	10	1446400000

Representative deratings curve

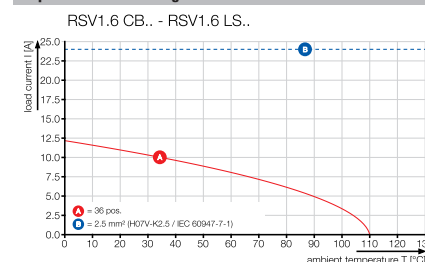

RSV1.6 LSF.. AU

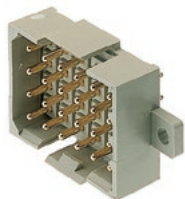

Dimensioned drawing

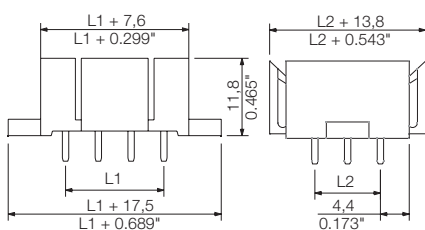

Ordering data

Solder pin length		3.2 mm	
Colour		Pebble grey	
Pitch		5.00 mm	
Pol.	L1	(inch)	Qty. Order No.
4	5.00	0.197	100 1440800000
6	10.00	0.394	50 1441800000
9	10.00	0.394	50 1442800000
12	15.00	0.591	25 1443800000
18	25.00	0.984	25 1444800000
24	25.00	0.984	20 1445800000
36	40.00	1.575	10 1446800000

Drilling diagrams

4-pole

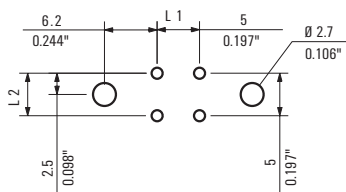

6-pole

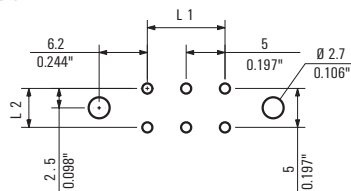

9-pole

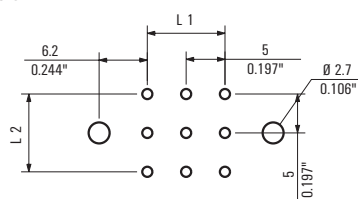

12-pole

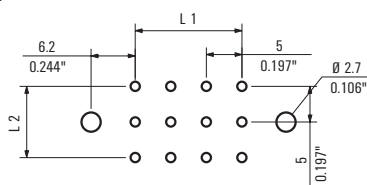

18-pole

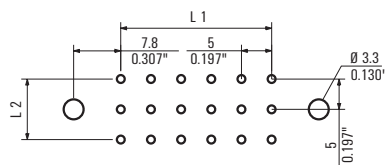

24-pole

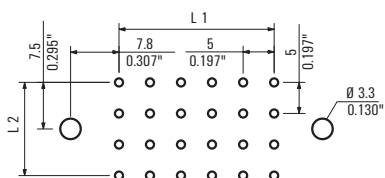

36-pole

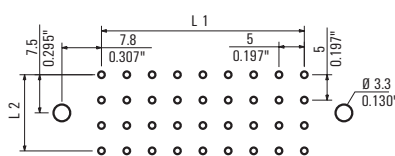

Additional deratings curves

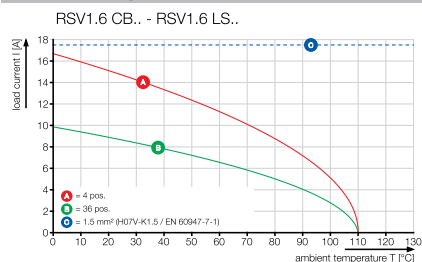

RSV1.6 LB.. AU

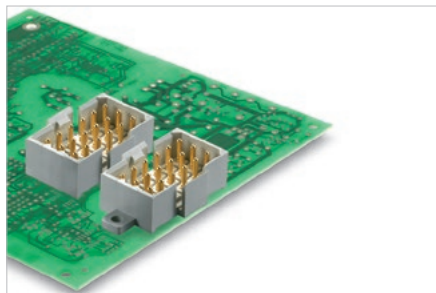

Rectangular plug-in female connector with solder contacts for PCB applications. High connection density achieved by using several rows and crimp contacts in the mating connector. The plug-in connectors can be coded and locked to the mating connector. Supplied in cardboard box.

Technical data

<b>In compliance with IEC 60664-1 / IEC 61984</b>			
Clamping range, max.			
<b>Solid core H05(07) V-U</b>			
Stranded H07 V-R			
Flexible H05(07) V-K			
Flexible with ferrule			
Ferrule with plastic collar			
Stripping length			
Screwdriver blade			
mm			
According to norm			
Tightening torque range			
<b>Rated current, max.</b>	<b>A</b>	<b>14</b>	<b>12</b>
At ambient temperature			
20°C 40°C			
For conductor cross-section			
Overvoltage category		III	III II
Pollution severity		3	2 2
<b>Rated voltage</b>	<b>V</b>	<b>250</b>	<b>320 500</b>
Rated impulse voltage			
kV 4 2.5 2.5			
<b>UL / CUL (Use Group)</b>			
<b>B C D</b>			
<b>Rated voltage</b>	<b>300</b>		
<b>Rated current</b>	<b>10</b>		
<b>AWG conductor</b>	<b>AWG</b>	<b>-</b>	
<b>CSA (Use Group)</b>			
<b>B C D</b>			
Rated voltage	300		
Rated current	13		
AWG conductor	AWG	-	
<b>General data</b>			
Type of insulation material	Wemid (PA)		
UL 94 flammability rating	V-0		
Contact base material	Copper alloy		
Material of contact surface	Gold-plated		
Pin dimensions = d	mm	0.97	
Solder eyelet Ø = D	mm	1.3	
Solder eyelet Ø tolerance	mm	+ 0,1	

Product data

IEC: 500 V / 14 A  
UL: 300 V / 10 A



For additional articles and information, refer to [catalog.weidmuller.com](http://catalog.weidmuller.com)

Note:

- Additional colours on request
- Rated current related to rated cross-section & min. No. of poles.
- Spacing between rows: see hole layout
- Rated data refer only to the component itself. Clearance and creepage distances to other components are to be designed in accordance with the relevant application standards.

RSV1.6 LB.. AU



Dimensioned drawing

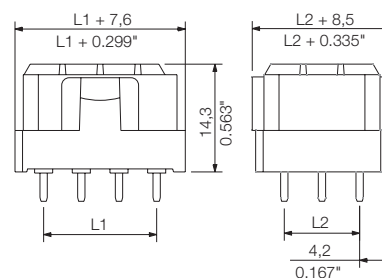

Ordering data

<b>Solder pin length</b>		<b>3.2 mm</b>	
<b>Colour</b>		<b>Pebble grey</b>	
<b>Pitch</b>	<b>5.00 mm</b>		
<b>Pol.</b>	<b>L1</b>	<b>(inch)</b>	<b>Qty. Order No.</b>
4	5.00	0.197	100 <b>1440200000</b>
6	10.00	0.394	50 <b>1441200000</b>
9	10.00	0.394	50 <b>1442200000</b>
12	15.00	0.591	25 <b>1443200000</b>
18	25.00	0.984	25 <b>1444200000</b>
24	25.00	0.984	20 <b>1445200000</b>
36	40.00	1.575	10 <b>1446200000</b>

Accessories

Note: Refer to the Accessories chapter for additional accessories.

<b>Coding</b>	<b>Order No.</b>
●	RSV1,6 K0 <b>1567430000</b>

Representative deratings curve

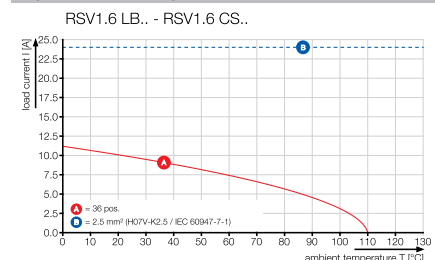

RSV1.6 LBF.. AU



Dimensioned drawing

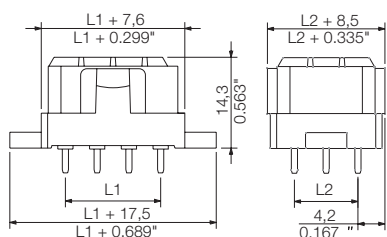

Ordering data

Solder pin length		3.2 mm		
Colour		Pebble grey		
Pitch		5.00 mm		
Pol.	L1	(inch)	Qty.	Order No.
4	5.00	0.197	100	1440600000
6	10.00	0.394	50	1441600000
9	10.00	0.394	50	1442600000
12	15.00	0.591	25	1443600000
18	25.00	0.984	25	1444600000
24	25.00	0.984	20	1445600000
36	40.00	1.575	10	1446600000

Drilling diagrams

4-pole

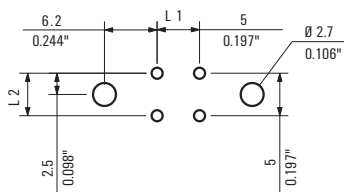

6-pole

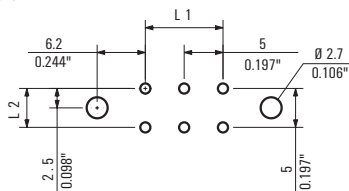

9-pole

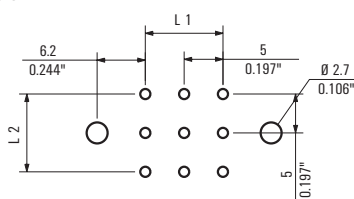

12-pole

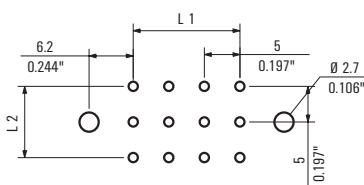

18-pole

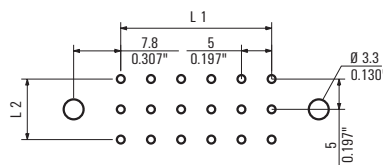

24-pole

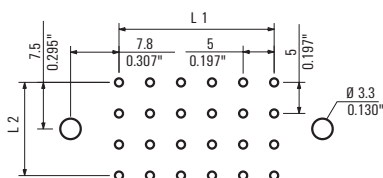

36-pole

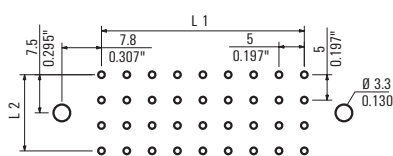

Additional deratings curves

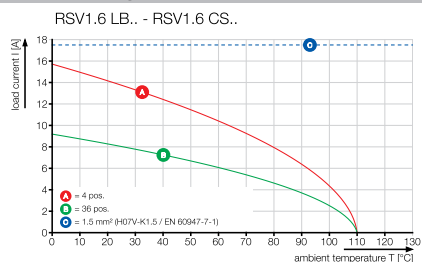

RSV1.6 CS.. & CB..



Rectangular plug-in connector for use with crimp contacts. Can be used as universal coupling, but also with the PCB variations. The crimp contacts guarantee a high connection density. The CS 1.6 or CB 1.6 contacts are used here. The connectors can be coded and locked together with their mates. Supplied in cardboard box.

Technical data

<b>In compliance with IEC 60664-1 / IEC 61984</b>			
Clamping range, max.	mm <sup>2</sup>	0.13...3.31	
<b>Solid core H05(07) V-U</b>			
Stranded H07 V-R	mm <sup>2</sup>	0.2...2.5	
Flexible H05(07) V-K	mm <sup>2</sup>	0.2...2.5	
Flexible with ferrule			
Ferrule with plastic collar			
Stripping length	mm	4	
Screwdriver blade	mm		
According to norm			
Tightening torque range			
<b>Rated current, max.</b>	<b>A</b>	<b>17</b>	<b>15</b>
At ambient temperature	20°C	40°C	
For conductor cross-section		III	II
Overtension category		3	2
Pollution severity		2	2
<b>Rated voltage</b>	<b>V</b>	<b>250</b>	<b>400</b>
Rated impulse voltage	kV	4	4
<b>UL / CUL (Use Group)</b>		<b>B</b>	<b>C</b>
<b>Rated voltage</b>			
<b>Rated current</b>			
<b>AWG conductor</b>	<b>AWG</b>		
<b>CSA (Use Group)</b>		<b>B</b>	<b>C</b>
Rated voltage		600	
Rated current		13	
AWG conductor	AWG	26-12	
<b>General data</b>			
Type of insulation material		Wemid (PA)	
UL 94 flammability rating		V-0	
Contact base material		Copper alloy	
Material of contact surface			
Pin dimensions = d	mm		
Solder eyelet Ø = D	mm		
Solder eyelet Ø tolerance	mm		

Product data

IEC: 630 V / 17 A  
UL: 600 V / 10 A / AWG 26 - 12



For additional articles and information, refer to [catalog.weidmueller.com](http://catalog.weidmueller.com)

Note:

- Additional colours on request
- Rated current related to rated cross-section & min. No. of poles.
- Spacing between rows: see hole layout
- Rated cross-section depends on crimp contact used.
- Rated data refer only to the component itself. Clearance and creepage distances to other components are to be designed in accordance with the relevant application standards.
- Max. outer diameter of the cable (with insulation): 3.5 mm

RSV1.6 CS..



Dimensioned drawing

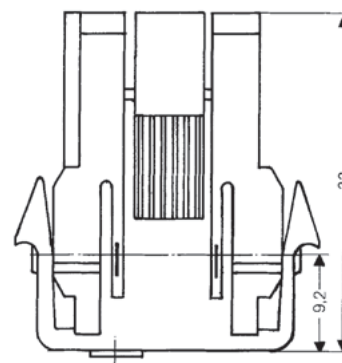

Ordering data

<b>Solder pin length</b>					
<b>Colour</b>					<b>Pebble grey</b>
<b>Pitch</b>	<b>5.00 mm</b>		<b>Qty.</b>	<b>Order No.</b>	
<b>Pol.</b>	<b>L1</b>	<b>(inch)</b>	<b>25</b>	<b>1413100000</b>	
4	5.00	0.197	25	<b>1413100000</b>	
6	10.00	0.394	25	<b>1414100000</b>	
9	10.00	0.394	25	<b>1415100000</b>	
12	15.00	0.591	25	<b>1416100000</b>	
18	25.00	0.984	25	<b>1417100000</b>	
24	25.00	0.984	20	<b>1418100000</b>	
36	40.00	1.575	10	<b>1419100000</b>	

Accessories

Note: Refer to the Accessories chapter for additional accessories.

<b>Release tool</b>		<b>Order No.</b>
	DW RSV 1.6	<b>9004530000</b>
<b>Crimping tool</b>		
	HTF RSV 16 WI	<b>9013560000</b>
<b>Clip-in foot</b>		
	RSV1,6 RF12/35x15 SW	<b>1690140000</b>
	RSV1,6 RF12/35x7.5 SW	<b>1582940000</b>
	RSV1,6 RF18/35x15 SW	<b>1690150000</b>
	RSV1,6 RF18/35x7.5 SW	<b>1582950000</b>
	RSV1,6 RF24/35x15 SW	<b>1690160000</b>
	RSV1,6 RF24/35x7.5 SW	<b>1582960000</b>
	RSV1,6 RF36/35x15 SW	<b>1690170000</b>
	RSV1,6 RF36/35x7.5 SW	<b>1582970000</b>
	RSV1,6 RF4/35x15 SW	<b>1690110000</b>
	RSV1,6 RF4/35x7.5 SW	<b>1582910000</b>
	RSV1,6 RF6/35x15 SW	<b>1690120000</b>
	RSV1,6 RF6/35x7.5 SW	<b>1582920000</b>
	RSV1,6 RF9/35x15 SW	<b>1690130000</b>
	RSV1,6 RF9/35x7.5 SW	<b>1582930000</b>
<b>Strain relief</b>		
	RSV1,6 ZE12 BK BX	<b>1563300000</b>
	RSV1,6 ZE18 BK BX	<b>1563200000</b>
	RSV1,6 ZE24 BK BX	<b>1563100000</b>
	RSV1,6 ZE36 BK BX	<b>1563000000</b>
	RSV1,6 ZE04 BK BX	<b>1563600000</b>
	RSV1,6 ZE06 BK BX	<b>1563500000</b>
	RSV1,6 ZE09 BK BX	<b>1563400000</b>
<b>Coding</b>		
	RSV1,6 KO	<b>1567430000</b>

Representative deratings curve

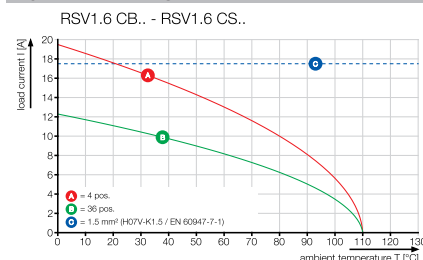

RSV1.6 CB..



Dimensioned drawing

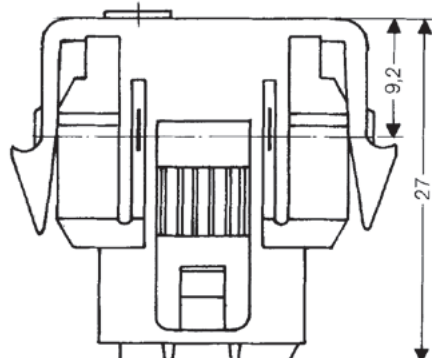

Ordering data

Solder pin length					
Colour		Pebble grey			
Pitch		5.00 mm			
Pol.	L1	(inch)	Qty.	Order No.	
4	5.00	0.197	25	1413000000	
6	10.00	0.394	25	1414000000	
9	10.00	0.394	25	1415000000	
12	15.00	0.591	25	1416000000	
18	25.00	0.984	25	1417000000	
24	25.00	0.984	20	1418000000	
36	40.00	1.575	10	1419000000	

Mounting cutout

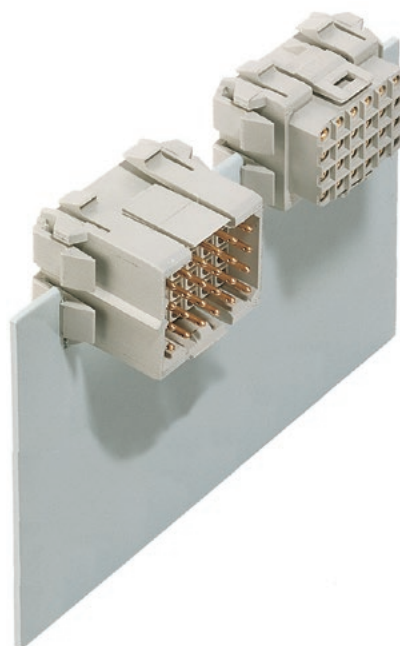

- Spring clips ensure firm hold in enclosure wall

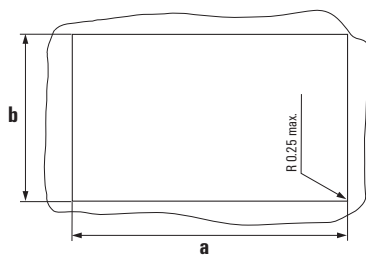

Mounting cutout for enclosure RSV 1.6  
Wall thickness 1.5...2.0 mm

No. of poles	Dim. a (mm)*	Dim. b (mm)*
4	20.3	17.8
6	25.1	18.1
9	25.1	24.0
12	30.0	24.0
18	40.5	24.0
24	40.5	28.3
36	55.5	28.3

\*) Tolerance: +0.3 mm

Contact system CB 1.6 / CS 1.6

CB 1.6 / CS 1.6

Crimp contacts

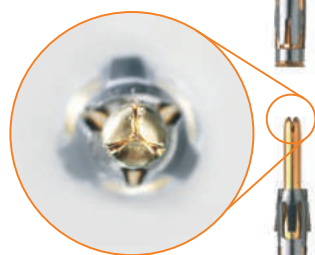
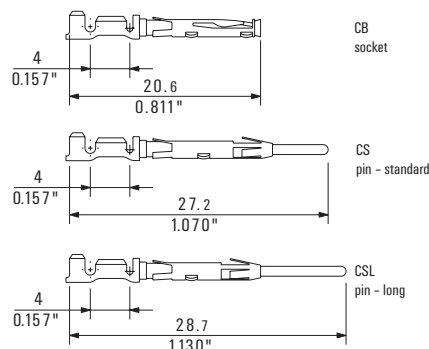

Ordering data

Tinned contacts			
For cable size mm <sup>2</sup>	AWG	Insulation diameter mm	
0.14 - 0.25	26 - 24	0.8 - 1.4	pin - standard
			pin - long
			socket
0.34 - 0.5	22 - 20	1.1 - 1.8	pin - standard
			pin - long
			socket
0.34 - 0.5	22 - 20	2.0 - 2.5	pin - standard
			pin - long
			socket
0.75 - 1.5	18 - 16	2.0 - 2.5	pin - standard
			pin - long
			socket
0.75 - 1.5	18 - 16	2.0 - 3.5	pin - standard
			pin - long
			socket
2.5	14 - 12	2.8 - 3.5	pin - standard
			pin - long
			socket
2.5	14 - 12	2.8 - 4.2	pin - standard
			pin - long
			socket

Separate contacts		Cont. on a strip	
Order No.	Qty.	Order No.	Qty.
1421600000	250	1421500000	5000
1421700000	250	1565900000	5000
1421900000	250	1421800000	5000
1423600000	250	1423500000	5000
1423700000	250	1565870000	5000
1423900000	250	1423800000	5000
1425600000	250	1425500000	5000
1425700000	250	1565840000	5000
1425900000	250	1425800000	5000
1427600000	250	1427500000	5000
1427700000	250	1565810000	5000
1427900000	250	1427800000	5000
1582270000	250	1582280000	3000
1582350000	250	1582360000	3000
1582430000	250	1582440000	3000
1429600000	250	1429500000	3000
1429700000	250	1565780000	3000
1429900000	250	1429800000	3000
1582310000	250	1582320000	3000
1582390000	250	1582400000	3000
1582470000	250	1582480000	3000

Ordering data

Tinned contacts			
For cable size mm <sup>2</sup>	AWG	Insulation diameter mm	
0.14 - 0.25	26 - 24	0.8 - 1.4	Stift - standard
			pin - long
			socket
0.34 - 0.5	22 - 20	1.1 - 1.8	Stift - standard
			pin - long
			socket
0.34 - 0.5	22 - 20	2.0 - 2.5	Stift - standard
			pin - long
			socket
0.75 - 1.5	18 - 16	2.0 - 2.5	Stift - standard
			pin - long
			socket
0.75 - 1.5	18 - 16	2.0 - 3.5	Stift - standard
			pin - long
			socket
2.5	14 - 12	2.8 - 3.5	Stift - standard
			pin - long
			socket
2.5	14 - 12	2.8 - 4.2	Stift - standard
			pin - long
			socket

Separate contacts		Cont. on a strip	
Order No.	Qty.	Order No.	Qty.
1420600000	250	1420500000	5000
1420700000	250	1565880000	5000
1420900000	250	1420800000	5000
1422600000	250	1422500000	5000
1422700000	250	1565850000	5000
1422900000	250	1422800000	5000
1424600000	250	1424500000	5000
1424700000	250	1565820000	5000
1424900000	250	1424800000	5000
1426600000	250	1426500000	5000
1426700000	250	1565790000	5000
1426900000	250	1426800000	5000
1582250000	250	1582260000	3000
1582330000	250	1582340000	3000
1582410000	250	1582420000	3000
1428600000	250	1428500000	3000
1428700000	250	1565760000	3000
1428900000	250	1428800000	3000
1582290000	250	1582300000	3000
1582370000	250	1582380000	3000
1582450000	250	1582460000	3000

- Safe centring of the contacts using the three-segment pin tips
- 4 defined contact points ensure high contact stability
- Lugs in the enclosing steel spring ensure the contact engages securely in the housing
- Pin contacts with two lengths to implement leading-pin contacts
- Up to 100 plugging cycles (tin version)
- Up to 500 plugging cycles (gold version)

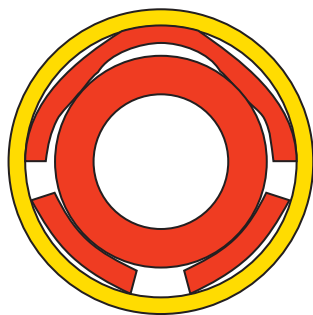



# OMNIMATE® Signal Accessories

<b>OMNIMATE® Signal Accessories</b>	Strain relief	I.2
	Snap-on foot	I.3
	Covers	I.4
	Lock / Fixing blocks	I.5
	Light guides	I.8
	Coding elements	I.10
	Dividing element	I.11
	Separator plates	I.12
	Disconnect element / Fuse element	I.13
	Marker carrier / LED holder	I.14
	Cross-connector / Test plug	I.15
	Identification systems	I.16
	IDC assembly blocks	I.19
	Crimping tools	I.20
	Disengaging tool / Removal tool	I.21
	Screwdrivers	I.22

## Strain relief

### BL 3.50 ZE BLZF 3.50 ZE

#### Strain relief



- Supports and protects the cable connections when removing the plug-in connector and during normal operation.
- Helpful when inserting and removing plug-in connector.

### BLZ 5.00 ZE BLZ 5.08 ZE

#### Strain relief



- Supports and protects the cable connections when removing the plug-in connector and during normal operation.
- Helpful when inserting and removing plug-in connector.

### BLT ZE

#### Strain relief



- Supports and protects the cable connections when removing the plug-in connector and during normal operation.
- Helpful when inserting and removing plug-in connector.

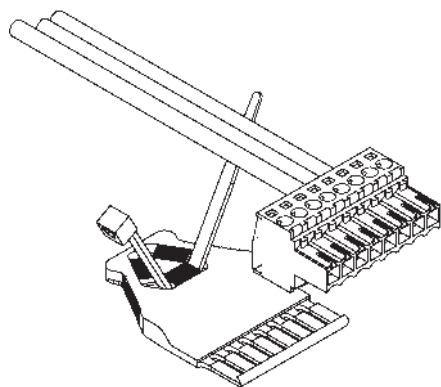

#### Ordering data

Colour		Orange	Black
No. of poles	Qty.	Order No.	Order No.
from 3	50	1629680000	1627820000
from 8	50	1629690000	1627830000

#### Ordering data

Colour			Orange	Black
No. of poles	Pitch (mm)	Qty.	Order No.	Order No.
from 4	5,00	50	1652100000	
from 8	5,00	50	1652040000	1652060000
from 4	5,08	50	1652110000	1652130000
from 8	5,08	50	1652050000	1652070000

#### Ordering data

Colour		Orange
No. of poles	Qty.	Order No.
from 4	50	1577980000
from 9	50	1578010000

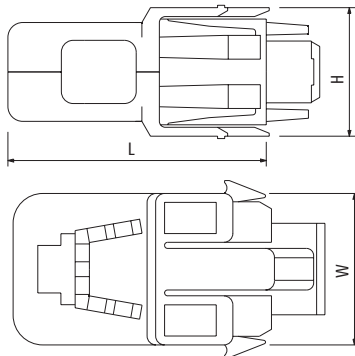
**RSV ZE****Strain relief****Ordering data**

Pole	W (mm)	L (mm)	H (mm)	Qty.	Order No.
4	20,50	39,00	22,20	10	1563600000
6	25,50	44,00	22,40	10	1563500000
9	25,50	44,00	28,40	10	1563400000
12	33,00	51,50	28,60	10	1563300000
18	40,00	58,50	28,60	10	1563200000
24	40,00	58,50	28,60	10	1563100000
36	55,00	73,50	32,60	10	1563000000

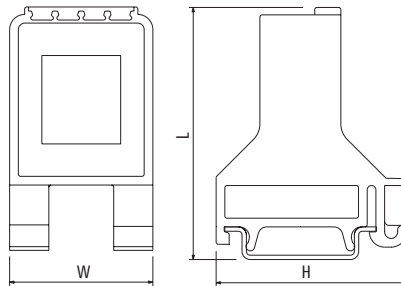
**RSV RF****Snap-on foot for terminal rail****Ordering data**

Snap-on foot for TS 35 x 7.5					Black
Pole	W (mm)	L (mm)	H (mm)	Qty.	Order No.
4	32,90	58,90	43,70	10	1582910000
6	32,90	58,90	43,70	10	1582920000
9	32,90	58,90	43,70	10	1582930000
12	32,90	58,90	43,70	10	1582940000
18	37,30	83,40	43,70	10	1582950000
24	37,30	83,40	43,70	10	1582960000
36	37,30	83,40	43,70	10	1582970000

Snap-on foot for TS 35 x 15					
Pole	W (mm)	L (mm)	H (mm)	Qty.	Order No.
4	32,90	65,40	43,70	10	1690110000
6	32,90	65,40	43,70	10	1690120000
9	32,90	65,40	43,70	10	1690130000
12	32,90	65,40	43,70	10	1690140000
18	37,30	90,90	43,70	10	1690150000
24	37,30	90,90	43,70	10	1690160000
36	37,30	90,90	43,70	10	1690170000

**B2L 3.50 AH**

**Cover**

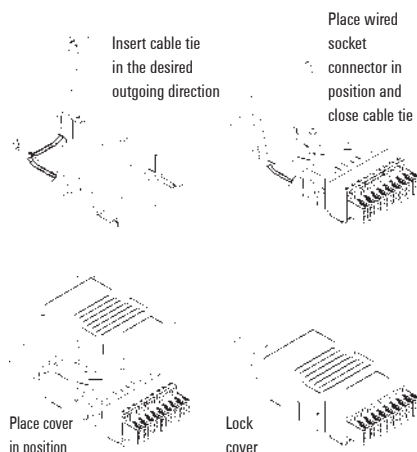
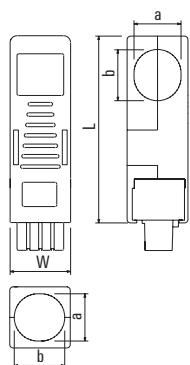

**Ordering data**

Pole	W (mm)	L (mm)	a (mm)	b (mm)	Qty.	Order No.
6	10,50	39,80	9,55	8,00	10	1781560000
8	14,00	39,80	9,55	8,00	10	1781570000
10	17,50	39,80	13,60	9,00	10	1781580000
12	21,00	39,80	13,60	9,00	10	1781590000
14	24,50	39,80	13,60	20,00	10	1781600000
16	28,00	39,80	13,60	20,00	10	1781610000
18	31,50	53,80	13,60	20,00	10	1781620000
20	35,00	53,80	13,60	20,00	10	1781630000
22	38,50	53,80	13,60	20,00	10	1781640000
24	42,00	53,80	13,60	20,00	10	1781650000
26	45,50	53,80	13,60	20,00	10	1781660000
28	49,00	53,80	13,60	20,00	10	1781670000
30	52,50	53,80	13,60	20,00	10	1781680000
32	56,00	53,80	13,60	20,00	10	1781690000
34	59,50	53,80	13,60	20,00	10	1781700000
36	63,00	53,80	13,60	20,00	10	1781710000

**BL 3.50 AH**

**Cover**

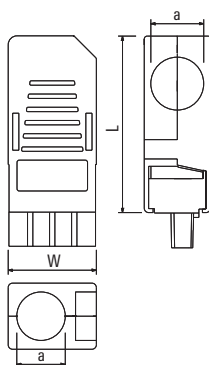

**Ordering data**

Pole	W (mm)	L (mm)	a (mm)	b (mm)	Qty.	Order No.
2	-	-	-	-	-	-
3	10,50	30,00	8,50	-	10	1745580000
4	14,00	30,00	8,50	-	10	1745590000
5	17,50	30,00	8,50	-	10	1745600000
6	21,00	30,00	8,50	-	10	1745610000
7	24,50	40,00	11,00	-	10	1745620000
8	28,00	40,00	11,00	-	10	1745630000
9	31,50	40,00	11,00	-	10	1745640000
10	35,00	40,00	11,00	-	10	1745650000
11	38,50	40,00	11,00	-	10	1745660000
12	42,00	40,00	11,00	-	10	1745670000
13	45,50	40,00	11,00	-	10	1745680000
14	49,00	40,00	11,00	-	10	1745690000
15	52,50	40,00	11,00	-	10	1745700000
16	56,00	40,00	11,00	-	10	1745710000

**BCZ 3.81 AH**

**Cover**

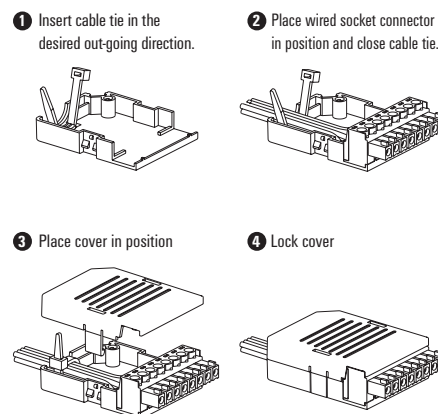
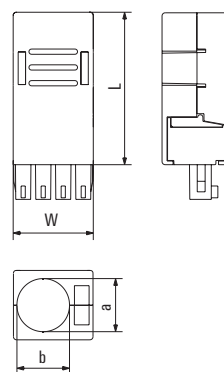

**Ordering data**

Pole	W (mm)	L (mm)	a (mm)	b (mm)	Qty.	Order No.
2	-	-	-	-	-	-
3	11,43	29	10	10	10	1005280000
4	15,24	29	10	10	10	1005290000
5	19,05	29	10	10	10	1005300000
6	22,86	29	10	10	10	1005310000
7	26,67	39	10	12,5	10	1005320000
8	30,48	39	10	12,5	10	1005330000
9	34,29	39	10	12,5	10	1005340000
10	38,1	39	10	13	10	1005350000
11	41,91	39	10	13,8	10	1005360000
12	45,72	39	10	14,6	10	1005370000
13	49,53	39	10	15,4	10	1005380000
14	53,34	39	10	16,2	10	1005390000
15	57,15	39	10	17	10	1005400000
16	60,96	39	10	17,8	10	1005410000

**BL/SL 3.50 VR**

**Lock**

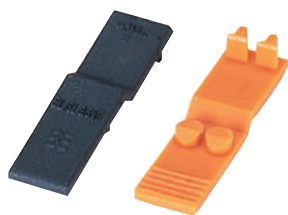

- Simple, screw-less, vibration-proof mechanism for all single-row male connectors in conjunction with the standard 180° screw terminal socket connector BL 3.5.
- 2 VR locks are recommended for plug-in connectors with more than 8 poles.

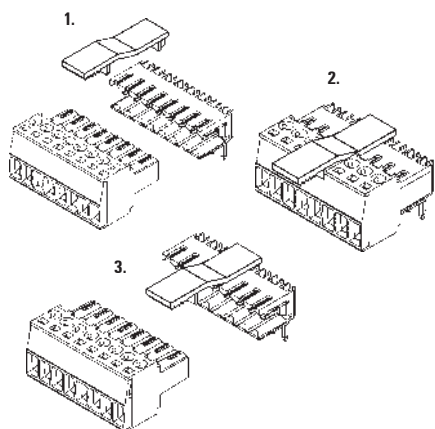

**Ordering data**

Colour		Orange	Black
No. of poles	Qty.	Order No.	Order No.
BL/SL 3.50 VR	100	1669310000	1669300000

**SLDF VR**

**Lock**

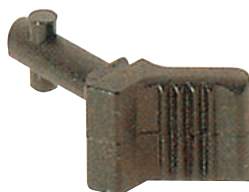

- For vibration-proof plug-in connections
- Socket must be B-Version with dovetail

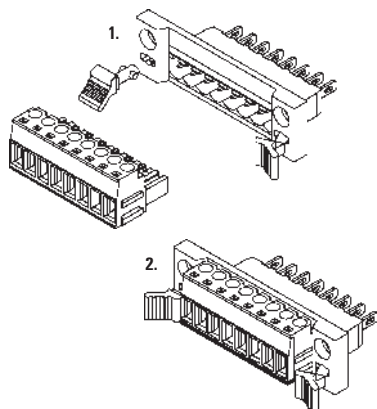

**Ordering data**

Colour		Black
Type	Qty.	Order No.
SLDF VR	100	1599120000

**BBDF**

**for universal feed-through-connection**



**Assembly Instruction**

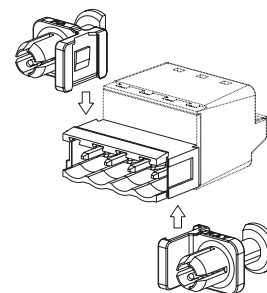

**view of BBDF inside the panel**

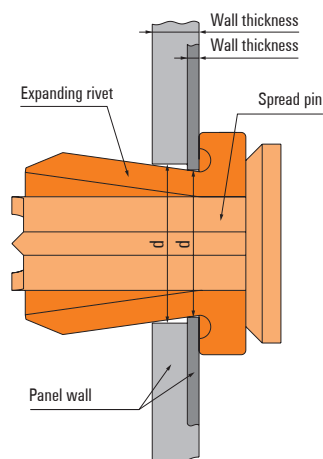

**Ordering data**

Colour		Orange	Black
Type	Width (mm)	Qty.	Order No.
BBDF	9,5	100	1307570000
			1307580000

## Fixing blocks

### SLA BB1R SLA BB11R

Mounting blocks for headers, in 5.0x-mm pitch

#### SLA BB11R



#### SLA BB1R

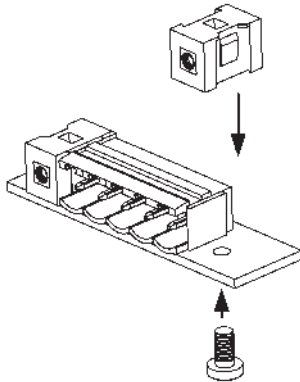
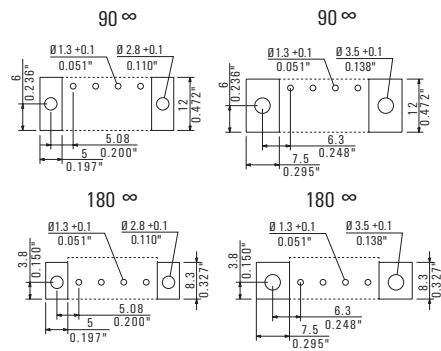

### SLA BB2R SLA BB12R

Mounting blocks for plugs, in 5.0x-mm pitch

#### SLA BB12R



#### SLA BB2R

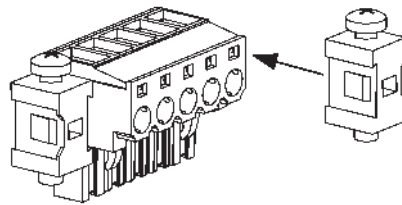
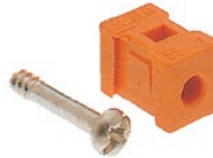

### SL 135 BB15R

Mounting blocks for SL 135 male header

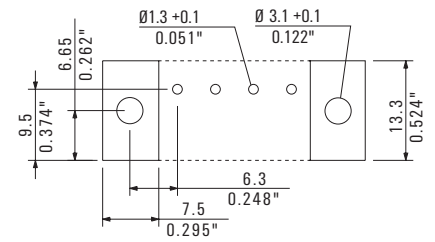

#### Ordering data

Colour			Orange	Black
Type	Width (mm)	Qty.	Order No.	Order No.
SLA BB1R	7,5	20	1723430000	1723480000
SLA BB11R	5,0	100	1604120000	1692340000

#### Ordering data

Colour			Orange	Black
Type	Width (mm)	Qty.	Order No.	Order No.
SLA BB2R	7,5	20	1723440000	1723490000
SLA BB12R	5,0	100	1593450000	1626880000

#### Ordering data

Colour			Orange	Black
Type	Width (mm)	Qty.	Order No.	Order No.
SL135 BB15R	7,5	20	1606450000	1636370000

**SLA BB14**

**Mounting blocks for SLD 5.08 headers**

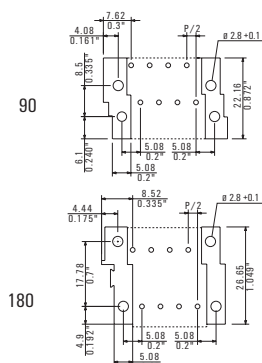
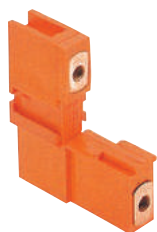

- Provides additional mechanical support for rows of male connectors on the PCB
- Also enables vibration-proof connections for the matching socket connectors.
- BB12 fixing blocks or an integral screw flange are required for the socket.
- Caution: Only to be used with SLD 5.08 90 / SLD 5.08 180.

**LPBB**

**PCB fixing block**

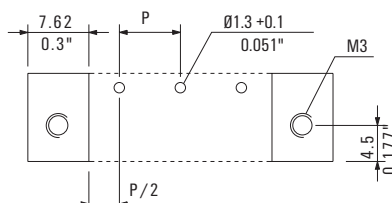

- Provides additional mechanical support for terminals LP, LP1N and LP 1H.
  - Can also be supplied with captive nut (LPBB MU).
- Ordering

**TOP 1.5 BB**

**Fixing block for TOP 1.5 GS terminals**

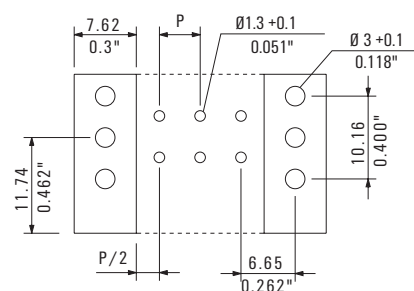

- Provides additional mechanical support for TOP 1.5 GS terminals.
- Supplied complete with 2.9 x 19 mm self-tapping screw.

**Ordering data**

Colour	Orange	Black
Type	Order No.	Order No.
SLA BB14	5,0	20
	1594200000	1774460000

**Ordering data**

Colour	Orange	Black
Type	Qty.	Order No.
LPBB	100	1747540000
LPBB MU	100	1747530000

**Ordering data**

Colour	Orange	Black
Type	Qty.	Order No.
TOP1.5 BB	20	1539860000

**S2L FLA**

Light guide

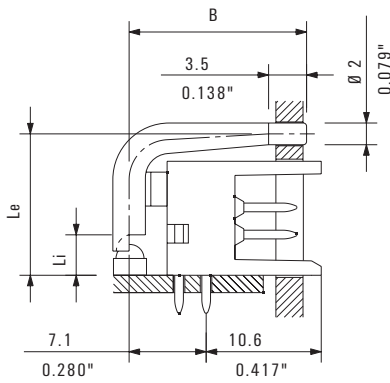
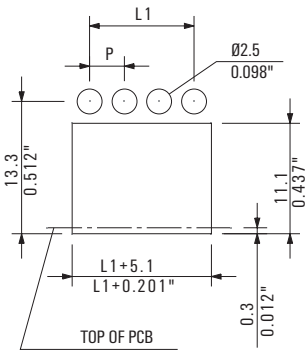

**Ordering data**

Pole	Li (mm)	Le (mm)	B (mm)	Qty.	Order No.
10	3,70	13,00	16,35	100	1699580000

**S2L-SMT FLA**

Light guide

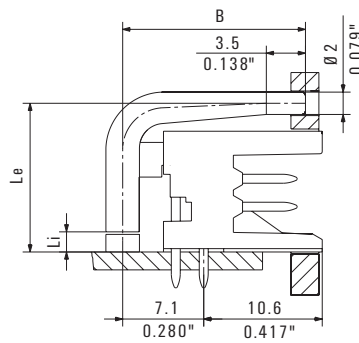
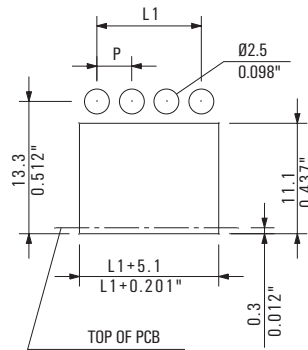

**Ordering data**

Pole	Li (mm)	Le (mm)	B (mm)	Qty.	Order No.
10	1,80	13,30	16,35	50	1814590000

**SL 3.50 FLA**

Light guide

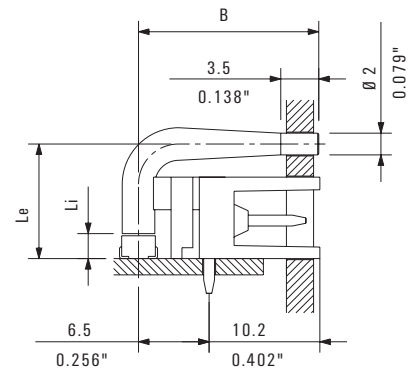
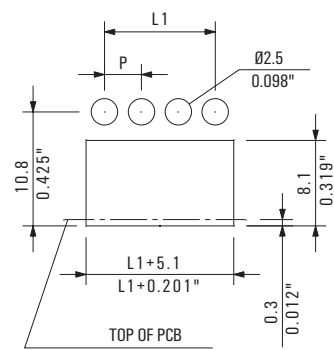

**Ordering data**

Pole	Li (mm)	Le (mm)	B (mm)	Qty.	Order No.
8	1,50	10,55	16,60	50	1597510000
8	2,30	10,55	16,60	50	1597520000
8	4,00	10,55	16,60	50	1597530000
8	1,50	10,55	14,85	50	1597630000
8	2,30	10,55	14,85	50	1597640000
8	4,00	10,55	14,85	50	1597650000



SC 3.81 FLA

Light guide

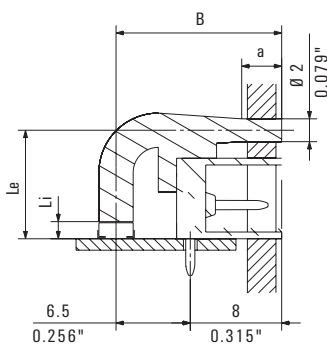
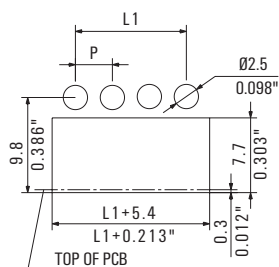

Ordering data

Pole	Li (mm)	Le (mm)	B (mm)	Qty.	Order No.
8	1,5	9,50	14,25	50	1979730000
8	2,3	9,50	14,25	50	1979750000
8	1,5	9,50	16,00	50	1979720000
8	2,3	9,50	16,00	50	1979740000

SL 5.08 FLA

Light guide

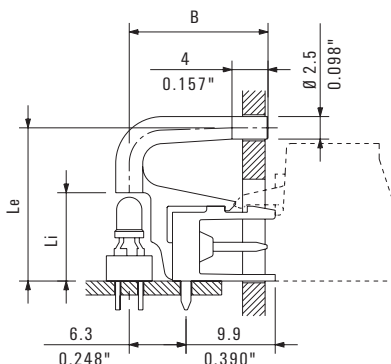
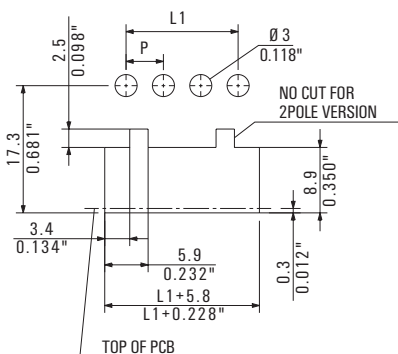

Ordering data

Pole	Li (mm)	Le (mm)	B (mm)	Qty.	Order No.
1	1,50	17,00	15,40	100	1580100000
1	2,30	17,00	15,40	100	1636670000
1	3,80	17,00	15,40	100	1580110000
1	9,00	17,00	15,40	100	1580120000
24	2,30	17,00	15,40	10	1636680000



**B2L/S2L KO – B2CF/S2C KO**

Coding element



- For coding plug-in connectors to prevent errors during installation.
- Suitable for plug and socket connectors.
- The coding does not block any poles.
- For reliable coding, we recommend at least 2 polarising pins per connector for 10-way and above

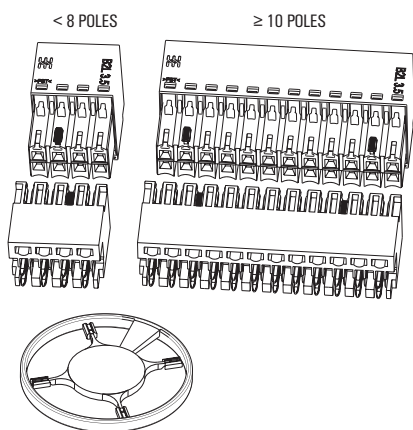

Ordering data

Colour		Orange	Black
Type	Qty.	Order No.	Order No.
B2L/S2L KO	100	1849730000	1849740000

**BL/SL 3.50 KO**

Coding element



- For coding plug-in connectors to prevent errors during installation.
- Suitable for plug and socket connectors.
- The coding does not block any poles.
- A coding star includes 2 coding elements of different sizes. The larger of the two is used on the male connector.

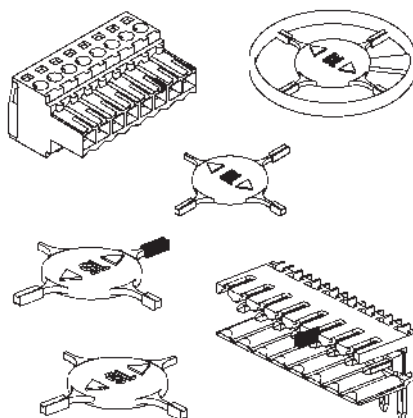

Ordering data

Colour		Orange	Black
Type	Qty.	Order No.	Order No.
BL/SL 3.5 KO	100	1693430000	1610100000

**SC-SMT 3.81 KO**

Coding element



- For coding connectors in order to prevent mistakes during installation
- Only for male headers (SC..3.81..).
- Female headers (BCZ 3.81, BCF 3.81 and BCL-SMT 3.81) are coded using diagonal-cutting pliers. The coding does not occupy a pole.

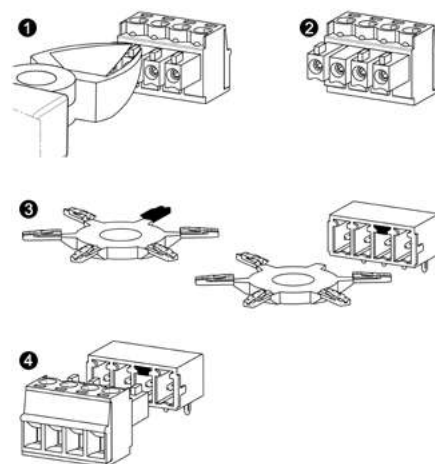

Ordering data

Colour		Grey
Type	Qty.	Order No.
SC-SMT 3.81 KO WT BX	100	2467670000

1 unit = 6 coding elements

**BLZ/SL KO****Coding element**

- For coding plug-in connectors to prevent errors during installation.
- Suitable for plug and socket connectors.
- The coding does not block any poles.
- Coding element for the BL/SL 5.00 and BL/SL 5.08 series

**RSV 1.6 KO****Coding element**

- For coding plug-in connectors to prevent errors during installation.
- Suitable for plug and socket connectors.
- The coding blocks individual poles.

**SLAT****Dividing element**

- Subdivides male connectors into distinct segments.
- Prevents errors during installation.

**Ordering data**

Colour		Orange	Black
Type	Qty.	Order No.	Order No.
BLZ/SL KO	100	1573010000	1545710000

**Ordering data**

Colour		Black
Type	Qty.	Order No.
RSV 1.6 KO	50	1567430000

**Ordering data**

Colour		Orange	Black
Type	Qty.	Order No.	Order No.
SLAT	100	1598300000	1770240000

## Separator plates

### LPZP 1.27/90

#### Separator plates

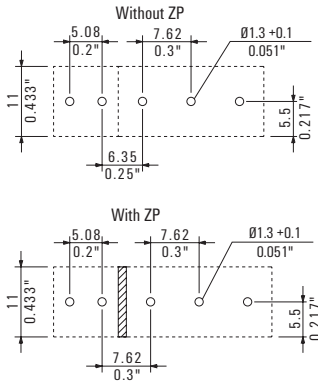

- Spacer plate for separating connections with different voltages and pitches.

### LPZP 2.54/90

#### Separator plates

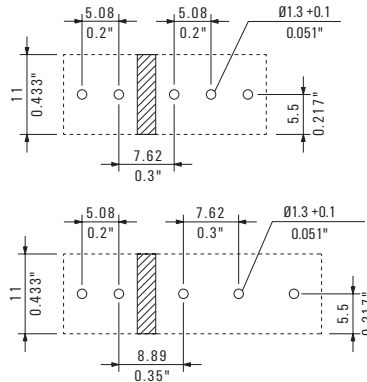

- For clear identification of phases in adjacent connections.
- Spacer plate for separating connections with different voltages and pitches.

### LPZP 2.54/135

#### Separator plates

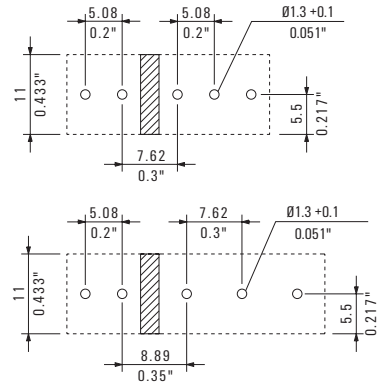

- For clear identification of phases in adjacent connections.
- Spacer plate for separating connections with different voltages and pitches.

#### Ordering data

Colour	Orange	Black
Type	Qty.	Order No.
LPZP 1.27/90	100	1747490000

#### Ordering data

Colour	Orange	Black
Type	Qty.	Order No.
LPZP 2.54/90	100	1747480000
		1747500000

#### Ordering data

Colour	Orange	Black
Type	Qty.	Order No.
LPZP 2.54/135	100	1753740000
		1753750000

**LPZP1N 2.54**

**Separator plates**

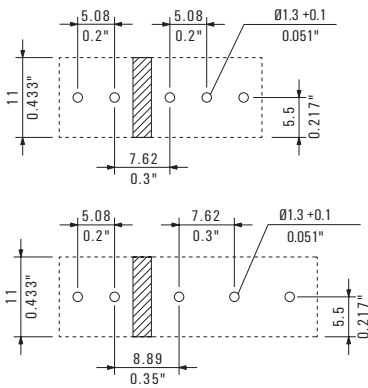

- For clear identification of phases in adjacent connections.
- Spacer plate for separating connections with different voltages and pitches.

**Ordering data**

Colour	Orange		Black	
Type	Qty.	Order No.	Order No.	Order No.
LPZP1N 2.54	100	1747470000	1747520000	

**LPA TR**

**Disconnect element**

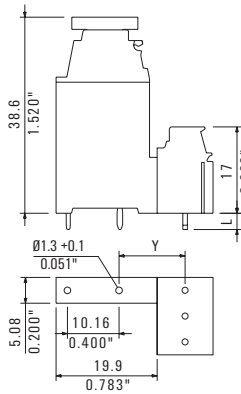

**Technical data**

	VDE	UL	CSA
Rated voltage	250 V	300 V	300 V
Rated current	9 A	10 A	10 A

- Can be fixed to the rear of all LP 90 terminals.
- DEKAFIX markers not included.

**Ordering data**

Type	Y (mm)		Qty.	Order No.
	with LP	with LPP		
LPA TR	12,8	15,2	100	1495460000

**LPA SI**

**Fuse element**

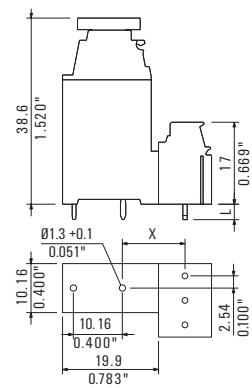

**Technical data**

	VDE	UL	CSA
Rated voltage	250 V	300 V	300 V
Rated current	6,3 A	10 A	10 A

- Can be fixed to the rear of all LP 5.08/90 terminals.
- Takes 5 x 25 cartridge fuses (DIN 820, IEC 127-2).
- Power loss = 1.6 W
- DEKAFIX markers not included.

**Ordering data**

Type	Y (mm)		Qty.	Order No.
	with LP	with LPP		
LPA SI	12,8	15,2	50	1495060000

LPA BZ

Marker carrier

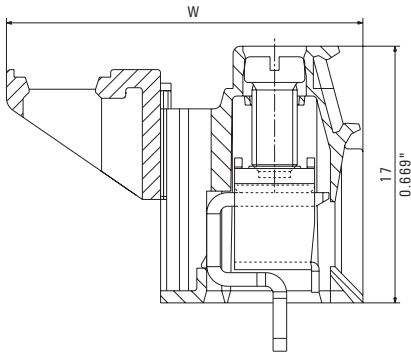

- For better marking of the connection clamps of the LP series
- Simply fixed to the back of the terminal.
- The WS 10/5 and WS 12/5 markers are not included with the delivery. Refer to the chapter on Accessories: Labelling Cards
- LEDs not included.

LPA FA

LED holder

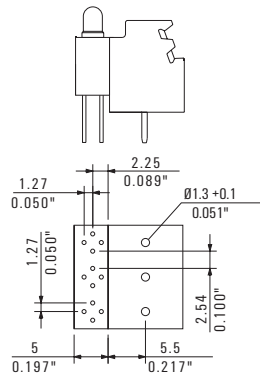

- Holder for standard 3 mm LEDs.
- Raised mounting position improves visibility of LEDs.
- Simply fixed to the back of the terminal.
- LEDs not included.

LPA FA BZ

LED holder with marker carrier

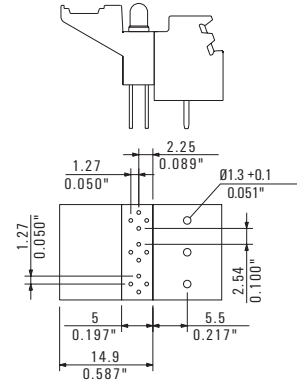

- For additional marking and fixing of three LEDs.
- Simply fixed to the back of the terminal.
- The WS 10/5 and WS 12/5 markers are not included with the delivery. Refer to the chapter on Accessories: Labelling Cards
- LEDs not included.

Ordering data

Pole	Colour	Width W		Qty.	Black
		with LP	with LPP		Order No.
2	LPA BZ2	21,2	23,6	100	1497260000
3	LPA BZ3	21,2	23,6	100	1497360000

Ordering data

Pole	Colour	Qty.	Black
			Order No.
2	LPA FA 2	50	1495960000
3	LPA FA 3	50	1496060000

Ordering data

Pole	Colour	Qty.	Black
			Order No.
2	LPA FA BZ2	50	1496160000
3	LPA FA BZ3	50	1496260000

### LPA QB

#### Cross-connector

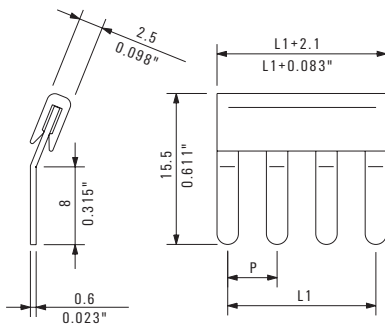

- For distributing potential after installation.
- Reduces the feasible conductor diameter to the next smaller cross-section.
- Not suitable for use with tension clamp spring connection.

#### Ordering data

Pole	Pitch	Type	Qty.	Order No.
2	5,08 mm	LPA QB2	50	1472200000
3	5,08 mm	LPA QB3	50	1472300000
4	5,08 mm	LPA QB4	50	1472400000
10	5,08 mm	LPA QB10	20	1472500000
17	5,08 mm	LPA QB17	20	1584770000
24	5,08 mm	LPA QB24	20	1472600000

### PS 2.0 MC

#### Test plug



- For conductors up to 0.75 mm<sup>2</sup> (AWG 18).
- Gold-plated lantern-type contact.
- Conductor must be soldered to contact in test plug.

#### Ordering data

Type	Conductor size	Qty.	Order No.
PS 2.0 MC	≤ 0,75 mm <sup>2</sup>	20	0310000000



**KSW 4 / KSW 2.5**

**Marking strips**



KSW marking strips are suitable for labelling multi-pole PCB terminals and connectors. The white, self-adhesive strips are made from a non-PVC, environmentally friendly material. These marking strips provide individual printing, i.e. are suitable for every pitch. Available in two widths: 2.5 and 4.0 mm.

**Technical data**

Material data	
Material	polyester with white surface
Adhesive	acrylic base
Temperature range	-40 °C to +150 °C
Min. bonding temperature	+4 °C
Flammability	self-extinguishing after 15 s

No. of marking strips per sheet	
up to 20 poles	= 20 strips per sheet
* more than 20 poles	= 15 strips per sheet

Ordering example	
Order No.	1630060001

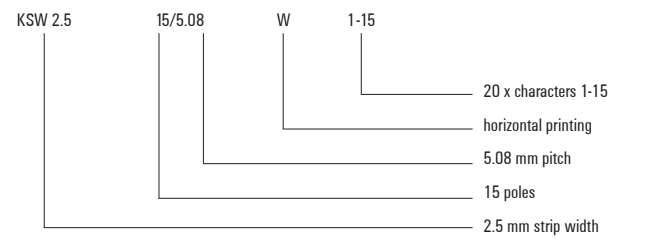

**Printed strips**

KSW 4	Pitch			
	3,50 mm	5,00 mm	5,08 mm	7,62 mm
Char.	1630190001	1700670001	1630200001	1700680001
1-8	-	-	-	1652270001
1-12	-	-	-	-
1-16	1630150001	1700700001	1630160001	-
1-24*	1640410001	1700710001	1630180001	-

KSW 2.5	Pitch			
	3,50 mm	5,00 mm	5,08 mm	7,62 mm
Char.	-	1700660001	1630100001	-
1-8	-	-	-	-
1-12	-	-	-	-
1-16	1652260001	1630070001	1713970001	-
1-24*	1652250001	1713980001	1713990001	-

**Blank strips**

	Length of strip		
	50 mm	100 mm	150 mm
KSW 4	1629970000	1629990000	1630010000
KSW 2.5	1629960000	1629980000	1630000000

**Custom printing to specification**

	Length of strip		
	50 mm	100 mm	150 mm
KSW 4	1629910000	1629930000	1629950000
KSW 2.5	1629900000	1629920000	1629940000

**Direct printing**



We can also print directly on your plug and socket connectors to your specification. Please ask for details.



DEK 5

Dekafix system



Dekafix is supplied in packs of 10 cards with 50 individual tags per card.

Dekafix tags are white with black printing as standard.

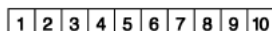

Horizontal printing

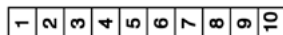

Vertical printing

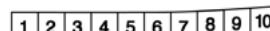

Mounted as strip



Mounted singly

Technical data

Material data	
Material	polyamide
Temperature range	- 40 °C to +100 °C
Flammability rating	UL 94 V-2
Contents	silicone-free, halogens below minimum detectable level self-extinguishing after 15 s
Mounting	as strips or singly depending on type of carrier
Printing	black printing, standard or to customer specification
Smudge resistance	to DIN IEC 50
Custom printing	according to list or data exchange by diskette or modem
Colour	to international colour code
Max. characters DEK 5	3 horizontal/3 vertical up to 2.5 mm font size

Custom printing to specification

Colour	Order No.	Colour	Order No.	Colour	Order No.	Qty. 500
(Note: please state colour when ordering.)						
○ white	1609810000	● yellow	1609810000	● violet	1609810000	
● black	1609810000	● green	1609810000	● grey	1609810000	
● red	1609810000	● blue	1609810000	● orange	1609810000	

Blank

Colour	Order No.	Colour	Order No.	Colour	Order No.	Qty. 500
● black	1457550000	● yellow	1609801687	● violet	1249860000	
● red	1609801686	● green	1609801688	● grey	1609801691	
● orange	1238340000	● blue	1609801693	○ white	0473360000	

Printed tags

(horizontal only)	Character	Order No.	Character	Horizontal	Vertical
Tags with individual letters	A	0522761021	50 consecutive numbers	1 ... 50	0473460001
	B	0522761022		51 ... 100	0473460005
	C	0522761023	1 2 3 4 5 6 7 8 9 10	to	The last 3 digits of the order No. indicate the first character.
	D	0522761024	11 12 13 14 15 16 17 18 19 20	951 ... 999	0473460951
	E	0522761025	10 consecutive numbers	1 ... 10	0523060001
	F	0522761026	1 2 3 4 5 6 7 8 9 10	11 ... 20	0523060011
	G	0522761027	11 12 13 14 15 16 17 18 19 20	to	The last 3 digits of the order No. indicate the first character.
	H	0522761028	Individual numbers	91 ... 100	0523060091
	I	0522761029	1 1 1 1 1 1 1 1 1 1	1	0522660001
	J	0522761030		2	0522660002
	K	0522761031		bis	The last 3 digits of the order No. indicate the first character.
	L	0522761032		200	0522660200
	M	0522761033	Various symbols	L1, L2, L3, N, PE	0354361187
	N	0522761034	L1 L2 L3 N PE L1 L2 L3 N PE		
	O	0522761035	Single symbols	plus +	0576261198
	P	0522761036	+ + + + + + + + + +	minus -	0576261199
	Q	0522761037	L1 L1 L1 L1 L1 L1 L1 L1 L1 L1	PE	-
	R	0522761038		L1	0522361075
	S	0522761039		L2	0522361076
	T	0522761040		L3	0522361077
	U	0522761041		earth	0576261202
	V	0522761042		earth in circle	0576261203
	W	0522761043		AC ~	0576261215
	X	0522761044		Individual card (state characters and orientation when ordering)	1609810000
	Y	0522761045		Coloured blank Dekafix (state colour when ordering)	1609801044
	Z	0522761046		Coloured printed Dekafix = custom printing (state colour and characters when ordering)	0490790000
					0490790000

**WS 10/5**  
**WS 12/5**

**MultiCard marking**



- WS 10/5 = 10 mm long x 5 mm wide
- WS 12/5 = 12 mm long x 5 mm wide
- Supplied as MultiCard 5 cards each with 144 markers

**S 10**

**Marker strips**



- Markers for TOP 4 terminals
- Supplied in packs of 100 strips with 10 markers per strip

**Ordering data**

Type	Length mm	Order No.
WS 10/5	10	<b>1635000000</b>
WS 12/5	12	<b>1609860000</b>

**Ordering data**

Printing	Qty.	Order No.
10 consecutive numbers (SF10)	0 ... 9	<b>0332400000</b>
	1 ... 10	<b>0331500001</b>
	11 ... 20	<b>0331500011</b>
Individual numbers (SF 10)	1	<b>0332500001</b>
	2	<b>0332500002</b>
	3	<b>0332500003</b>
	4	<b>0332500004</b>
	5	<b>0332500005</b>
	6	<b>0332500006</b>
	7	<b>0332500007</b>
	8	<b>0332500008</b>
	9	<b>0332500009</b>
Blank		<b>0332500000</b>
Custom printing on request*		

\* A minimum order quantity can be agreed for custom printing.

**BLIDC B 3.5 ASB**

**IDC assembly block**

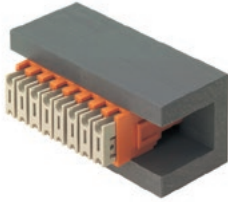

**Wiring the module**

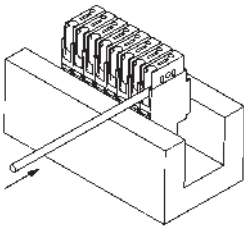
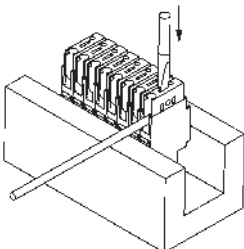
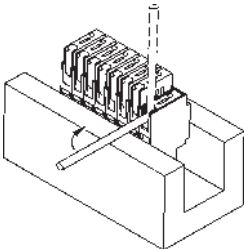
1.  Insert conductor as far as possible.
2.  Insert screwdriver into centre opening and press down.
3.  Module is engaged and conductor is now connected.

**Detaching the module**

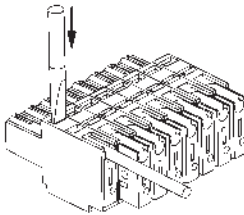
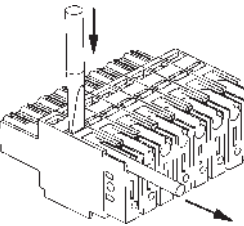
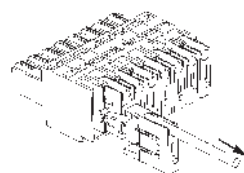
1.  Insert screwdriver into first opening and press down.
2.  Insert screwdriver into second opening and press down.
3.  Module is now disengaged and can be pulled out.

**Ordering data**

Type	Qty.	Order No.
BLIDCB 3.5	1	1770310000



Crimping tools

HTF 28  
HTF 63

Crimping tools

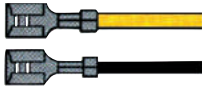

- Precision crimping tool with ratchet for 2.80 and 6.30 mm spade connections with open or rolled terminals
- HTF 28 for flexible conductors 0.10-1.00 mm<sup>2</sup> (AWG 26-16)
- HTF 63 for flexible conductors 0.50-2.50 mm<sup>2</sup> (AWG 20-14)

HTF DFF

Crimping tools



- Precision crimping tool with ratchet for the Weidmüller DFFC crimp contacts of BLC and BLAC socket connectors
- 0.22-0.35 mm<sup>2</sup> (AWG 24-22)
- 0.50-1.00 mm<sup>2</sup> (AWG 20-17)
- 1.50-2.50 mm<sup>2</sup> (AWG 16-12)

HTF RSV 12  
HTF RSV 16

Crimping tools

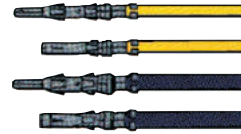

- Precision crimping tool with ratchet for the Weidmüller CB and CS crimp contacts of RSV 1.6 plug-in connectors
- RSV 16 = 0.14 - 1.50 mm<sup>2</sup> (AWG 26-16)
- RSV 12 = 1.50 - 2.50 mm<sup>2</sup> (AWG 14-12)

Ordering data

Type	Crimp size mm/inch	Cross-section mm <sup>2</sup> /AWG	Order No.
HTF 28	2,8/0,110	0,14-1,5/26-16	9013090000
HTF 63	6,3/0,250	0,50-2,5/20-14	9013400000

Ordering data

Type	Cross-section mm <sup>2</sup> /AWG	Order No.
HTF DFF	0,22-2,5/24-12	9014140000

Ordering data

Type	Cross-section mm <sup>2</sup> /AWG	Order No.
HTF RSV 16	0,14-1,5/26-16	9013560000
HTF RSV 12	1,50-2,5/14-12	9013550000

**DFFC EW2**

Disengaging tool

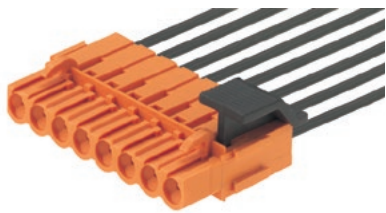

**Ordering data**

Type	Qty.	Order No.
DFFC EW2	1	1803790000

**DW RSV**

Disengaging tool

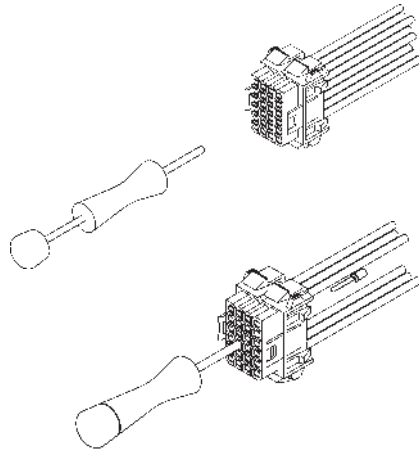

**Ordering data**

Type	Qty.	Order No.
DW RSV 1.6	1	9004530000



**SDI**

**VDE-insulated slotted screwdriver**

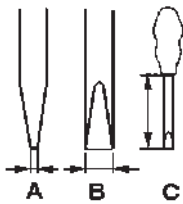

**VDE-insulated slotted screwdriver, SDI**

- DIN 7437, ISO 2380/2
- Output acc. to DIN 5264, ISO 2380/1
- SoftFinish® handle



**SD**

**Slotted screwdriver with round blade**

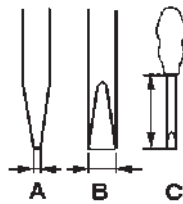

**Slotted screwdriver with round blade, SD**

- DIN 5265, ISO 2380/2
- Output acc. to DIN 5264, ISO 2380/1
- ChromTop tip
- SoftFinish® handle



**SDK PH**

**Crosshead screwdriver**



**Crosshead screwdriver PH (Philips)**

- SDK PH DIN 5262, ISO 8764/2-PH
- Output acc. to ISO 8764-PH
- ChromTop tip
- SoftFinish® handle



**Crosshead screwdriver PZ (PoziDrive)**

- SDK PZ DIN 5262, ISO 8764/2-PZ
- Output acc. to ISO 8764-PZ
- ChromTop tip
- SoftFinish® handle



**Ordering data**

Type	Dims. (mm)	A	B	C	Order No.
SDI	0,4	2,5	75		9008370000
SDI	0,5	3,0	100		9008380000
SDI	0,6	3,5	100		9008390000
SDI	0,8	4,0	100		9008400000
SDI	1,0	4,5	125		9008910000
SDI	1,0	5,5	125		9008410000
SDI	1,2	6,5	150		9008420000
SDI	1,6	8,0	175		9008430000

**Ordering data**

Type	Dims. (mm)	A	B	C	Order No.
SD	0,4	2,5	75		9009030000
SD	0,5	3,0	80		9008320000
SD	0,6	3,5	100		9008330000
SD	0,8	4,0	100		9008340000
SD	0,8	4,5	125		9009020000
SD	1,0	5,5	150		9008350000
SD	1,2	6,5	150		9009010000

**Ordering data PH**

Type	Dims. (mm)	A	B	C	Order No.
SDK PH0	0			60	9008470000
SDK PH1	1			80	9008480000
SDK PH2	2			100	9008490000
SDK PH3	3			150	9008500000

**Ordering data PZ**

Type	Dims. (mm)	A	B	C	Order No.
SDK PZ1	1			80	9008530000
SDK PZ2	2			100	9008540000
SDK PZ3	3			150	9008550000

**Tension clamp terminal tool**

**Tool for PCB terminals with tension clamp connection**

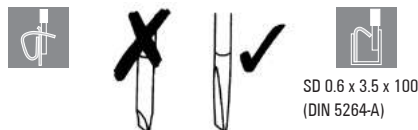

You do not need any special tool to connect or disconnect our tension clamp connection.  
The opening is designed to accommodate a standard 0.6 x 3.5 x 100 screwdriver 9008330000 to DIN 5264-A (with flat blade).

# OMNIMATE® Power PCB terminals

<b>OMNIMATE® Power PCB terminals</b>	Clamping yoke screw connection	Explanation	J.2	
		Quick selection	J.12	
		Product selection	J.16	
	<hr/>			
	PUSH IN-spring connection	Explanation	J.6	
		Quick selection	J.14	
Product selection		J.26		
<hr/>				

# OMNIMATE® Power – LL 6.35 power terminal

## Unrestricted use up to 600 V to UL 1059 approval in 6.35 mm pitch

**Your device connections increasingly require international approval to UL 1059 to 600 V. We offer you the matching power terminal in 6.35 mm pitch. Let's connect.**

International UL certification for 600 V is an important factor for many power electronics applications. The wiring must also be safe and maintenance-free and meet the high insulator requirements.

Our LL 6.35 power terminal meets all the certification criteria unrestricted. Not only is it especially safe, but it has an extremely compact 6.35 mm pitch design.

You will receive a maintenance-free solution with proven clamping yoke screw technology for conductors up to 6 mm<sup>2</sup>. Ideal for device connections in drive technology, power supply, solar inverter and line filter applications.

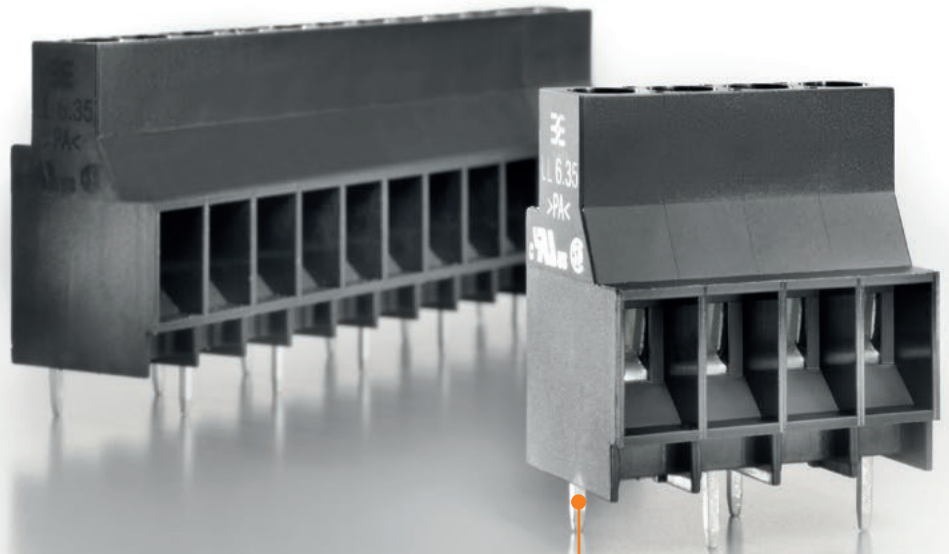

600 V



### Clever design

The staggered solder pins are a speciality of the LL 6.35. These pins provide the required clearance and creepage distances for unrestricted 600 V certification to UL 1059.

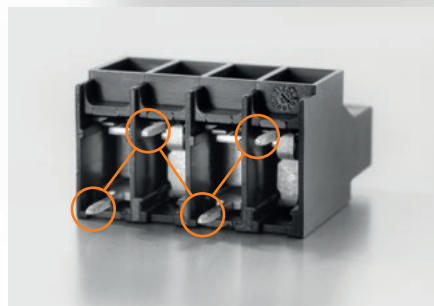



**Clear marking**

The design of the LL 6.35 allows individual direct labelling on three possible levels. This allows a direct assignment and avoids installation errors.

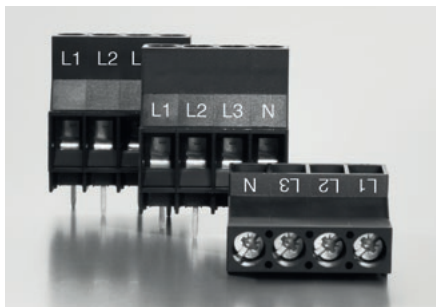

**Safe operation**

The world-wide compatible screw head allows an interference fit bolted joint that can be operated using all standard tools and power tools.

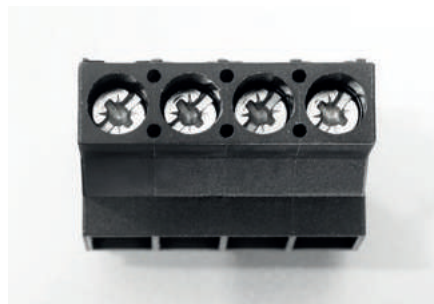

**High-quality insulation**

The insulating material WEMID satisfies the highest environmental standards, is creep-current resistant to CTI 600 and fire resistant to UL 94-V0. With a continuous operating temperature of 120 °C it exceeds the standard value of PA (100 °C) by 20 K.

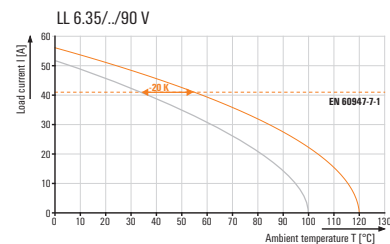

**Safe fire resistance**

The use of high-quality plastics allows compliance with the increased requirements for fire safety in accordance with the household appliance standard IEC 60335-1.



**Can be ordered online**

Order your sample world-wide directly from the OMNIMATE® online catalogue at [www.sample-service.com](http://www.sample-service.com)

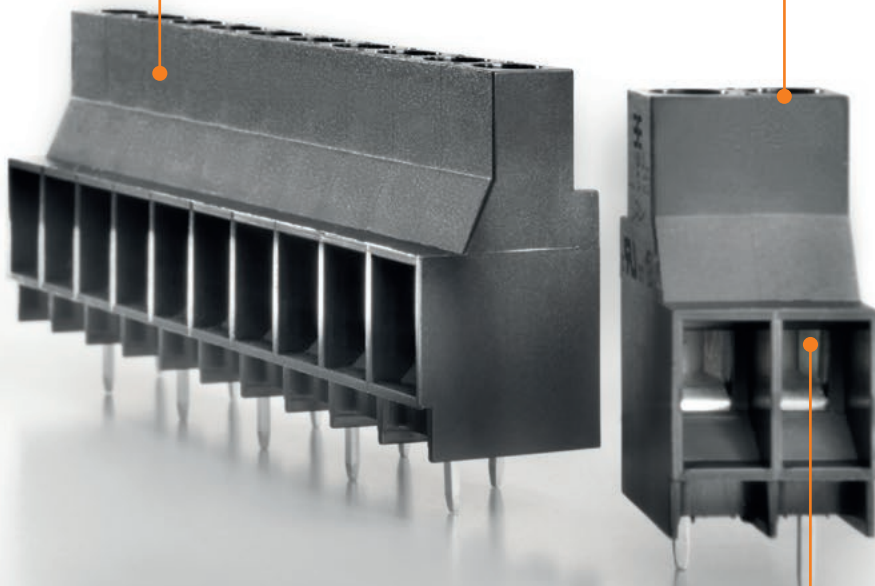

**Maintenance-free terminal point**

A vibration resistant and maintenance-free connection is made using our proven WIRE GUARD and WIRE READY clamping yoke screw connection.

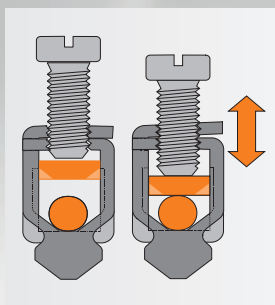

# OMNIMATE® Power PCB terminals

## High-power connections up to 150 A / 1,000 V

The OMNIMATE® Power PCB terminals – ranging from the LUP in 10.16-mm pitch to the LXXX in 15.00-mm pitch – is approved for unlimited international use in applications according to UL 1059 (600 V) and IEC (1,000 V). Weidmüller’s self-securing steel clamping yoke is 100 % maintenance free. It provides vibration-proof connections to the PCB for wires up to 50 mm<sup>2</sup>.

### Unrivalled clamping

With an unmatched clamping range, the LXXX 15.0 offers a safe and strong wire connection for cross-sections up to 50 mm<sup>2</sup> / AWG1 and 150 A to the circuit board.

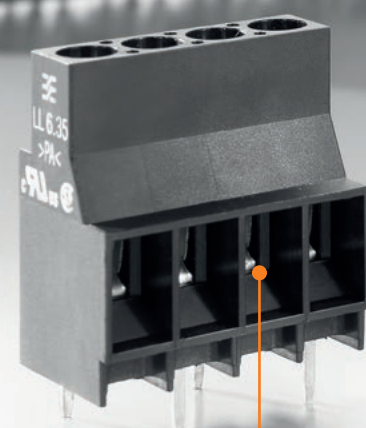
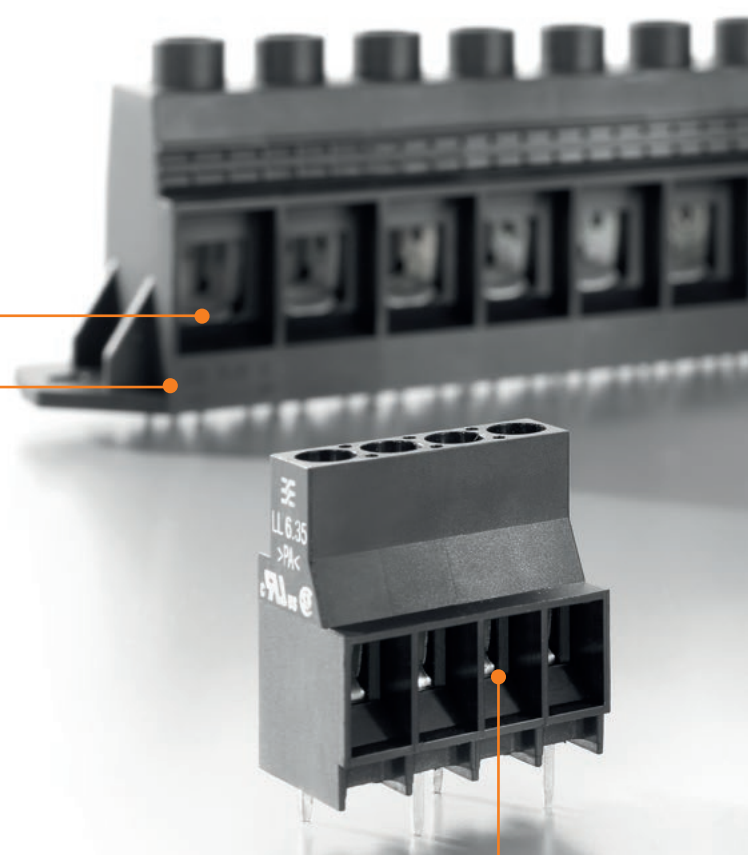

### Power reserve for safety

The high-performance WEMID insulation material helps increase the availability of the system. With an RTI (relative temperature index) of 120 °C, the OMNIMATE® Power PCB terminals exceed the upper continuous-use temperature recommended by the Standard PA (100 °C) by 20 °C. Thus there are more power reserves and improved safety in event of temperature fluctuations or overloads.

### Screw connection system

The automatically counter-operating Weidmüller steel clamping yoke uses force generated by tightening the screw to open the upper thread. Settling of the connected wires and vibrations are compensated for and this guarantees a maintenance free operation. Subsequent tightening and maintenance of the screw is not needed.

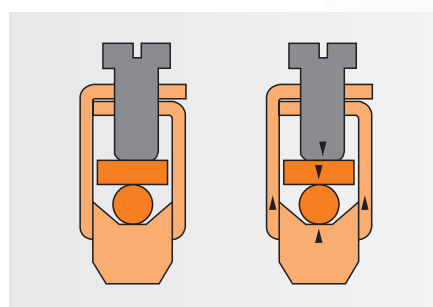
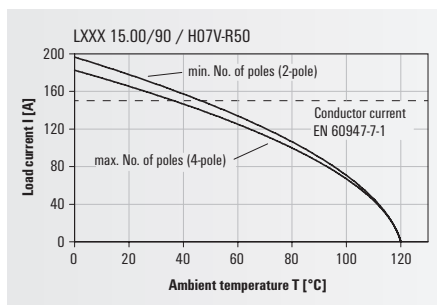

**Standard-compliant integration**

Weidmüller terminals meet the extended creepage and clearance distances according to UL and finger safety in accordance with the IEC 61800-5-1 device standard.



**Wire protection**

The integrated "Wire Guard" mechanism on the OMNIMATE® Power PCB terminals prevents wires from being inserted improperly and prevents a malfunctioning contact.



**Integrated test point**

The required maintenance and measurements can be carried out in a safe, reliable and convenient manner.



**Labelling and assigning**

Terminals are available with custom direct printing, versatile Dekafix labelling, affordable adhesive strips and colour coding.



## Reliable and fast connection of power electronics devices

### LUF and LUFS series PCB terminal with PUSH IN connection

Maximum performance with increased economic efficiency – these are the current trends in the field of power electronics. In order to achieve this goal, devices must combine excellent functionality with simple operation. This will have an impact on the device connectivity systems, which need to be fault-free, safe and quick in their usage.

The LUF PCB terminal from the OMNIMATE® Power product range features proven PUSH IN connection technology. This has allowed us to carry out tool-free wiring for wire cross-sections up to 16 mm<sup>2</sup> and to meet requirements in accordance with UL 1059 for 600 V in the 10.00 mm pitch and with 1,000 V in the 15.00 mm pitch.

LUF(S) provides high levels of contact reliability based on the Weidmüller Connection Safety Concept. The terminal contact shuts automatically to prevent malfunction. LUF has a tool-free wiring system, and LUFS can be actuated with a simple screwdriver to connect cross sections up to 16 mm<sup>2</sup>. The PUSH IN connection system also allows a quick, convenient and therefore efficient wiring.



#### Compliant with UL 1059

As a result of the offset arrangement of the solder pins, the LUF 15.00 and also the LUFS 15.00 allows unrestricted international use in applications in accordance with UL 1059 up to 1,000 V.

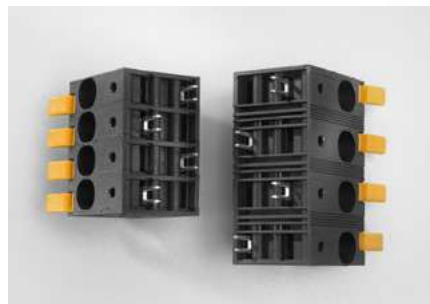

**Comfortable actuation**

An ergonomic lever makes it easy to open the clamp and release the wire. The contact point for LUF can be opened comfortably by hand, and LUFS can be opened using a standard screwdriver.

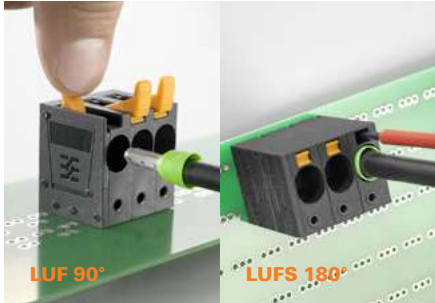

**Convenient access to test points**

In order to provide maximum flexibility, LUF 90° offers two test points – one beside the cable entry and another beside the actuating lever side. LUFS 180° features one test point located beside the cable entry.

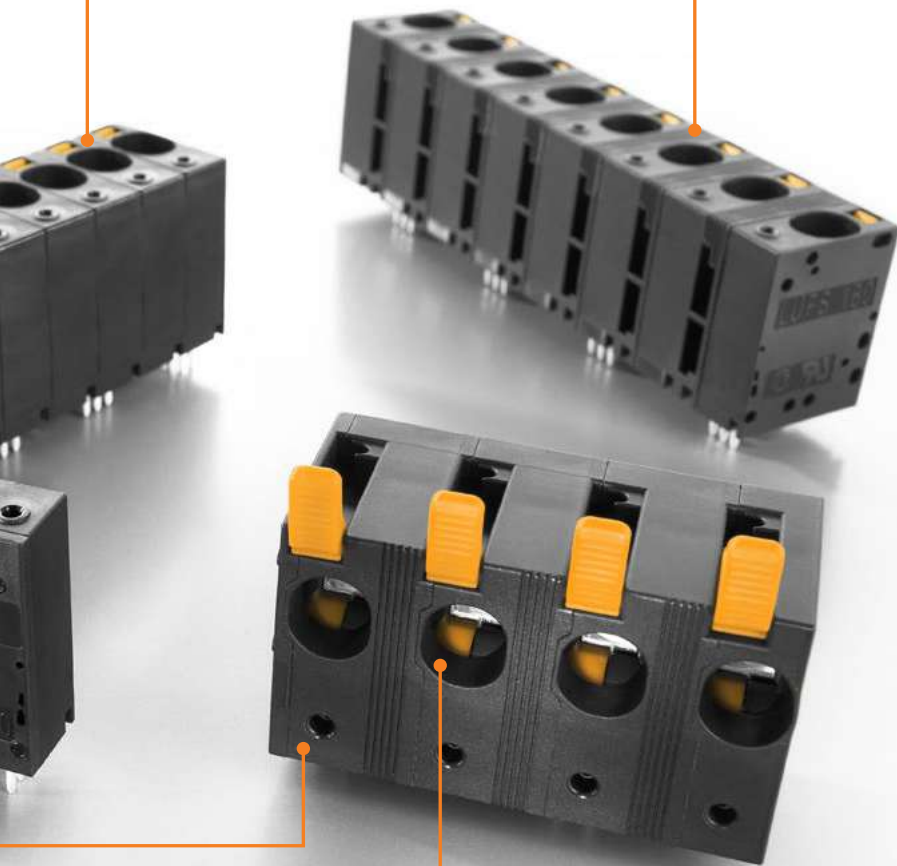
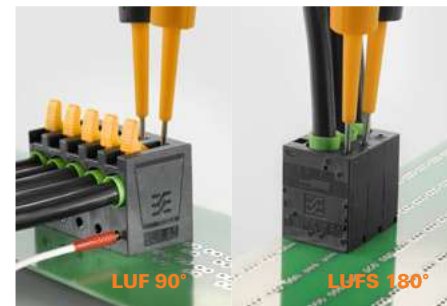

**Your special advantages:**

**Perfect connection thanks to high levels of contact reliability**

This contact system is automatically closed after being opened. This intelligent Connection Safety Concept helps to ensure that the wire is always connected safely.



The LUF and LUFS are not only proving to be impressive thanks to their good performance and easy operability – ensured by the unusually high level of contact reliability – but also meets all the challenges that arise in power electronic applications.

**PUSH IN connection up to 16 mm<sup>2</sup>**

The PUSH IN connection system allows for wires to be connected to the PCB board without the need for tools. Solid wires or wires with ferrules can be directly connected. Done!

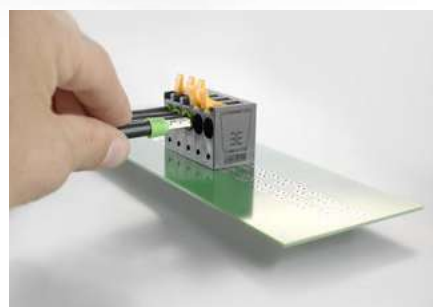

## Reliable and fast connection in power electronic applications LLF 7.50 PCB terminal with PUSH IN connection system

Modern systems and technology – for example, photovoltaic inverters – underlie continuous development and optimisation. Technological advances often depend on powerful, flexible and robust connectivity systems to ensure secure and reliable operation.

The LLF PCB terminal from the OMNIMATE® Power product range features proven PUSH IN connection technology. This has allowed us to carry out tool-free wiring for wire cross-sections up to 6 mm<sup>2</sup> and to meet requirements in accordance with UL 1059 for 600 V in pitch 7.5 mm.

Just like the PCB terminals LUF and LUFS, LLF uses the Weidmüller “Connection Safety Concept”, which has a PUSH IN connection for quick and safe mounting. The actuation lever allows for quick, simple, and safe wiring with excellent performance.

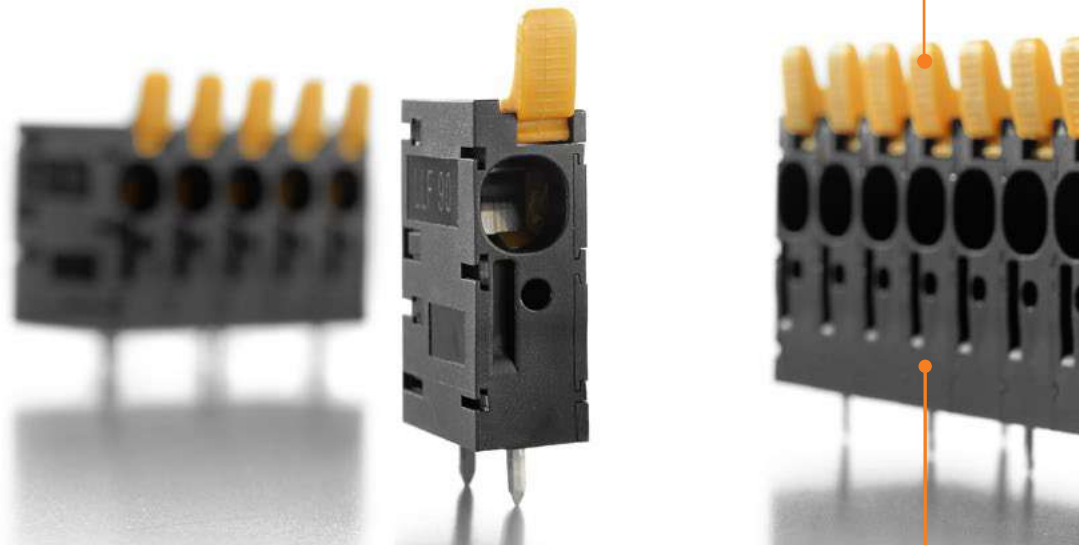

**Compliant with UL 1059 up to 600 V**  
As a result of the offset arrangement of the solder pins, the LLF allows unrestricted international use in applications in accordance with UL 1059 up to 600 V.

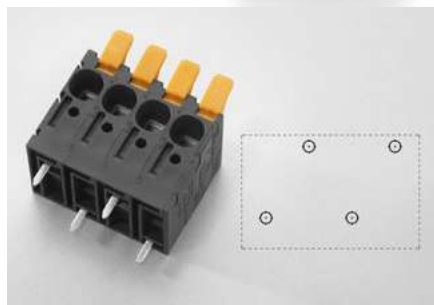

**High level of reliability**

LLF provides high levels of contact reliability based on the "Connection Safety Concept". The terminal contact closes automatically to prevent malfunction.



**Convenient access to test points**

Two test points with LLF, one located beside the cable entry and another beside the actuating lever, provide a great flexibility during testing.

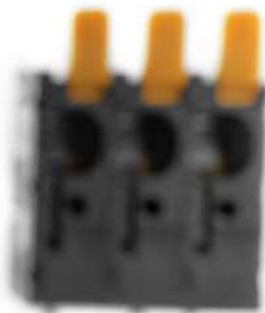
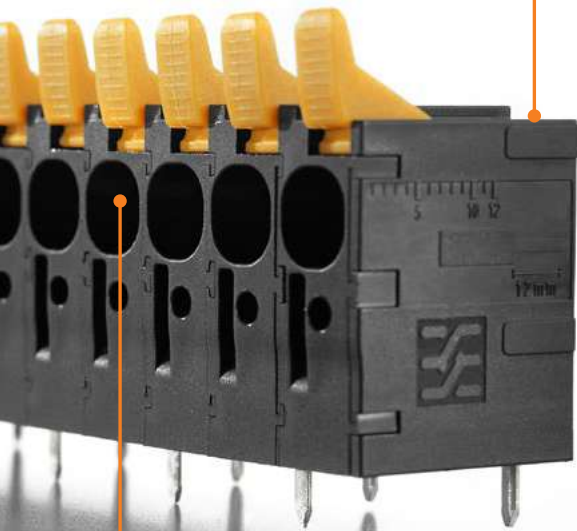
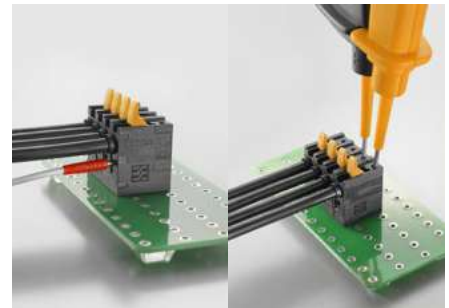

**Tool-free wiring system**

The PUSH IN connection and the simple and safe operation of the actuator lever ensure quick, convenient and efficient wiring of cross sections up to 6 mm<sup>2</sup>.

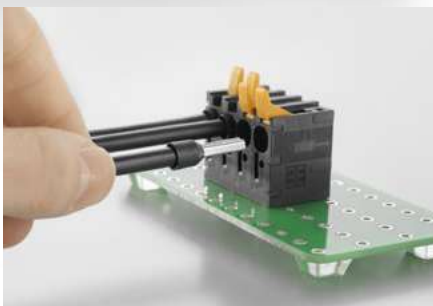

**Your special advantages:**

**Comfortable actuation**

The ergonomically designed lever allows an operator to easily actuate and open clamp in order to release the cable. The contact point get readily opened by hand without the need for any physical exertion.

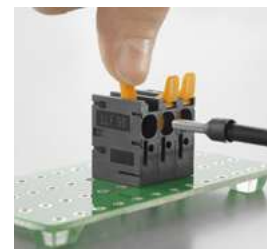

LLF is capable of handling challenging applications that not only require high current and voltage but also demand a secure connectivity. LLF maximises connection safety and reliability within a compact space.



## Safe and efficient connection of power electronics devices

### New: LUF 10.00 with PUSH IN in accordance with UL 1059 for 600 V

Maximum performance with increased economic efficiency – these are the current trends in the field of power electronics. In order to achieve this goal, devices must combine excellent functionality with simple operation. This will have impact on the device connectivity systems, which needs to be fault-free, safe and quick in his usage.

The LUF PCB terminal from the OMNIMATE® Power product range features tried-and-tested PUSH IN connection technology. This has allowed us to realise tool-free wiring for wire cross-sections up to 16 mm<sup>2</sup> and to meet requirements in accordance with UL 1059 for 600 V in the 10.00 mm pitch.

In addition to the particularly simple handling of the actuator lever, the LUF also provides high levels of contact reliability that is based on the “Connection Safety Concept” from Weidmüller. The quick and safe wire connection with PUSH IN connection system as well as the simple and safety operation of the actuator lever for opening the contact allow a quick, convenient and therefore economical wiring.



**According to UL 1059 up to 600 V**  
As a result of the offset arrangement of the solder pins, the LUF allows unrestricted international use in applications in accordance with UL 1059 up to 600 V.





**Easy actuation**

The contact point can be opened without any physical exertion and without the need of any special tools. It can be done by hand or using a simple screwdriver.

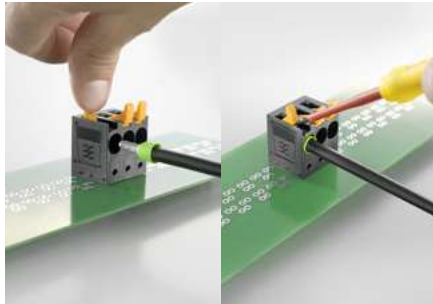

**Available for testing at any time**

Easily accessible diagnostic testing points for necessary maintenance and measurements in direction of cable entry or on the actuating lever side allows the using of tester or connector PS2.

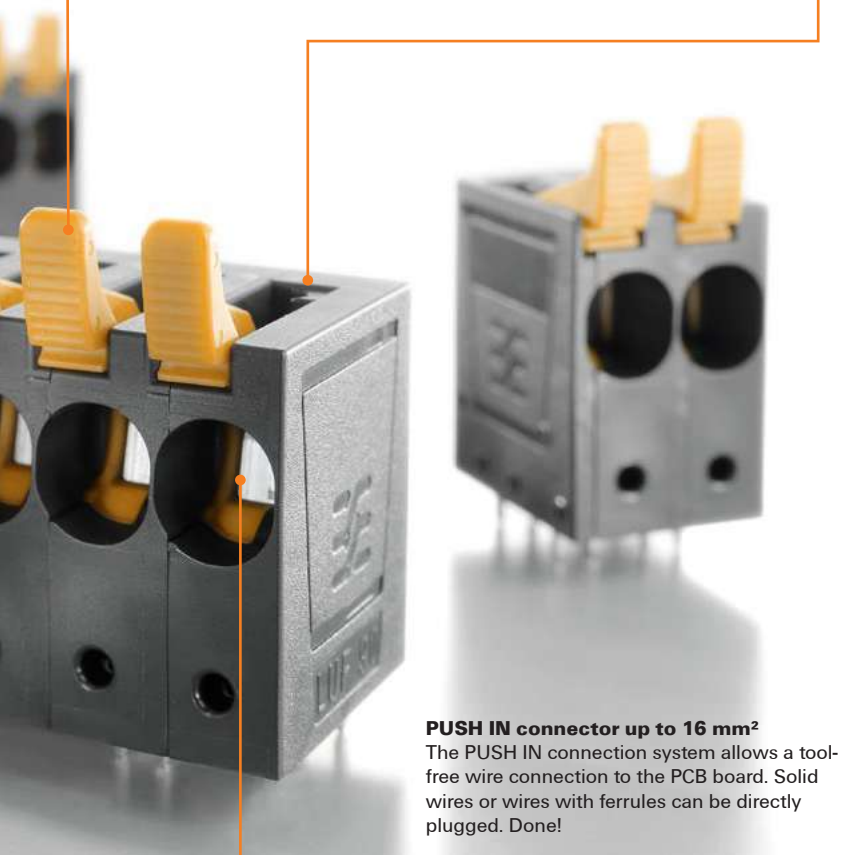
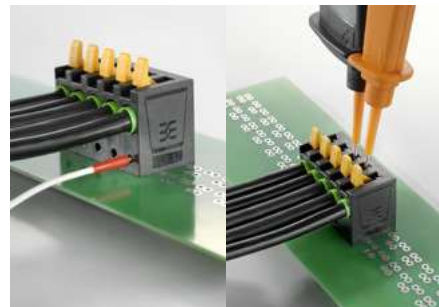

**PUSH IN connector up to 16 mm<sup>2</sup>**

The PUSH IN connection system allows a tool-free wire connection to the PCB board. Solid wires or wires with ferrules can be directly plugged. Done!

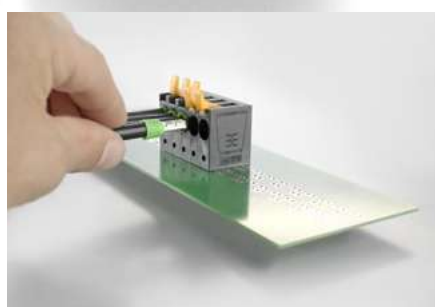

**Your special advantages:**

Perfect connection thanks to high levels of contact reliability

This contact system is getting automatically closed after it was opened. This intelligent "Connection Safety Concept" helps ensure that the wire is always safely connected.

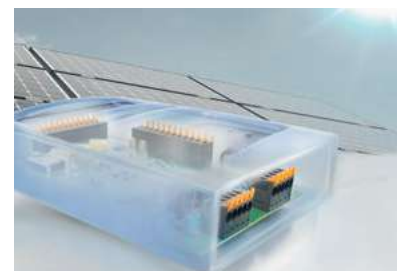

The LUF is not only impressive concerning performance and easy operability – due to the particularly high level of contact reliability, this PCB terminal meets all the challenges of power-electronics applications.



<http://www.OMNIMATE.net>

- = 300 V (UL) / 1,000 V (IEC)
- = 600 V (UL) / 1,000 V (IEC)

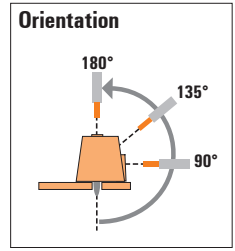

## PCB terminals

Type of connection	Clamping range	Type	IEC / UL	90°	135°	180°	
<b>Screw</b>	<b>≤ 6 mm<sup>2</sup></b>		<b>LL 6.35/./90 V*</b>	IEC: 1,000 V/32 A/0.18 - 6 mm <sup>2</sup> UL: 600 V/30 A/AWG 26 - 10	●		
			<b>LU 10.16</b>	IEC: 1,000 V/76 A/0.5 - 16 mm <sup>2</sup> UL: 300 V/65 A/AWG 26 - 6	●		
	<b>≤ 16 mm<sup>2</sup></b>		<b>LUP 10.16</b>	IEC: 1,000 V/76 A/0.5 - 16 mm <sup>2</sup> UL: 300 V/58 A/AWG 26 - 6	●		
			<b>LUP 10.16/./90 V*</b>	IEC: 1,000 V/76 A/0.5 - 16 mm <sup>2</sup> UL: 600 V/51 A/AWG 22 - 6	●		
			<b>LUP 12.70</b>	IEC: 1,000 V/76 A/0.5 - 16 mm <sup>2</sup> UL: 600 V/58 A/AWG 26 - 6	●		
	<b>≤ 25 mm<sup>2</sup></b>		<b>LX 15.00</b>	IEC: 1,000 V/101 A/0.5 - 25 mm <sup>2</sup> UL: 600 V/85 A/AWG 16 - 4	●		
			<b>LXB 15.00</b>	IEC: 1,000 V/101 A/1.5 - 25 mm <sup>2</sup> UL: 600 V/85 A/AWG 16 - 4	●		
	<b>≤ 50 mm<sup>2</sup></b>		<b>LXXX 15.00</b>	IEC: 1,000 V/150 A/0.5 - 50 mm <sup>2</sup> UL: 600 V/127 A/AWG 20 - 1	●		
			<b>LXXX 15.00/./90F</b>	IEC: 1,000 V/150 A/0.5 - 50 mm <sup>2</sup> UL: 600 V/127 A/AWG 20 - 1	●		

\* With offset solder pins

Pitch, in mm	6.35	10.16	12.70	15.00
Max. rated voltage, IEC	1,000 V			
UL nominal voltage UL	600 V	300 V	600 V	
	●			
		○		
		○		
			●	
			●	
				●
				●
				●
				●
				●
				●
				●
				●
				●
				●
				●
				●
				●

OMNIMATE® Power PCB terminals



**J**

<http://www.OMNIMATE.net>

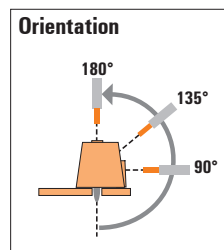
300 V  
 600 V  
 1.000 V



### PCB terminals

Type of connection	Clamping range	Type	IEC / UL	90°	135°	180°
PUSH IN	≤ 6 mm <sup>2</sup>	 <b>LLF 7.50/90</b>	IEC: 600 V / 41 A / 0.5 - 6 mm <sup>2</sup> UL: 300 V / 35 A / AWG 24 - AWG 8	●		
		 <b>LLF 7.50/90V*</b>	IEC: 1000 V / 41 A / 0.5 - 6 mm <sup>2</sup> UL: 600 V / 35 A / AWG 24 - AWG 8	●		
		 <b>LLFS 7.50/180</b>	IEC: 1000 V / 41 A / 0.5 - 6 mm <sup>2</sup> UL: 300 V / 37 A / AWG 24 - AWG 8			●
		 <b>LLFS 7.50/180V*</b>	IEC: 1000 V / 41 A / 0.5 - 6 mm <sup>2</sup> UL: 600 V / 37 A / AWG 24 - AWG 8			●
		 <b>LLFS 7.50/90</b>	IEC: 1000 V / 41 A / 0.5 - 6 mm <sup>2</sup> UL: 300 V / 37 A / AWG 24 - AWG 8	●		
		 <b>LLFS 7.50/90V*</b>	IEC: 1000 V / 41 A / 0.5 - 6 mm <sup>2</sup> UL: 600 V / 37 A / AWG 24 - AWG 8	●		
PUSH IN	≤ 16 mm <sup>2</sup>	 <b>LUF 10.00/90</b>	IEC: 1000 V / 76 A / 0.5 - 16 mm <sup>2</sup> UL: 300 V / 61 A / AWG 18 - AWG 6	●		
		 <b>LUF 10.00/90V*</b>	IEC: 1000 V / 76 A / 0.5 - 16 mm <sup>2</sup> UL: 600 V / 58 A / AWG 18 - AWG 6	●		
		 <b>LUFS 10.00/180</b>	IEC: 1000 V / 76 A / 0.5 - 16 mm <sup>2</sup> UL: 600 V / 61 A / AWG 18 - AWG 6			●
		 <b>LUFS 10.00/180V*</b>	IEC: 1000 V / 76 A / 0.5 - 16 mm <sup>2</sup> UL: 600 V / 58 A / AWG 18 - AWG 6			●
		 <b>LUFS 10.00/90</b>	IEC: 1000 V / 76 A / 0.5 - 16 mm <sup>2</sup> UL: 600 V / 61 A / AWG 18 - AWG 6"	●		
		 <b>LUFS 10.00/90V*</b>	IEC: 1000 V / 76 A / 0.5 - 16 mm <sup>2</sup> UL: 600 V / 58 A / AWG 18 - AWG 6	●		
PUSH IN	≤ 16 mm <sup>2</sup>	 <b>LUF 15.00/90</b>	IEC: 1000 V / 76 A / 0.5 - 16 mm <sup>2</sup> UL: 600 V / 66 A / AWG 20 - AWG 4	●		
		 <b>LUF 15.00/90V*</b>	IEC: 1000 V / 76 A / 0.5 - 16 mm <sup>2</sup> UL: 600 V / 66 A / AWG 20 - AWG 4	●		
		 <b>LUF 15.00/180</b>	IEC: 1000 V / 76 A / 0.5 - 16 mm <sup>2</sup> UL: 600 V / 66 A / AWG 20 - AWG 4			●
		 <b>LUFS 15.00/90V*</b>	IEC: 1000 V / 76 A / 0.5 - 16 mm <sup>2</sup> UL: 600 V / 66 A / AWG 20 - AWG 4			●

\* mit versetzten Lötstiften

Pitch, in mm	7,50			10,00			15,00		
Rated voltage IEC	600 V	1000 V	1000 V	600 V	1000 V	1000 V	600 V	1000 V	1000 V
Rated voltage UL	300 V	300 V	600 V	300 V	300 V	600 V	300 V	300 V	600 V

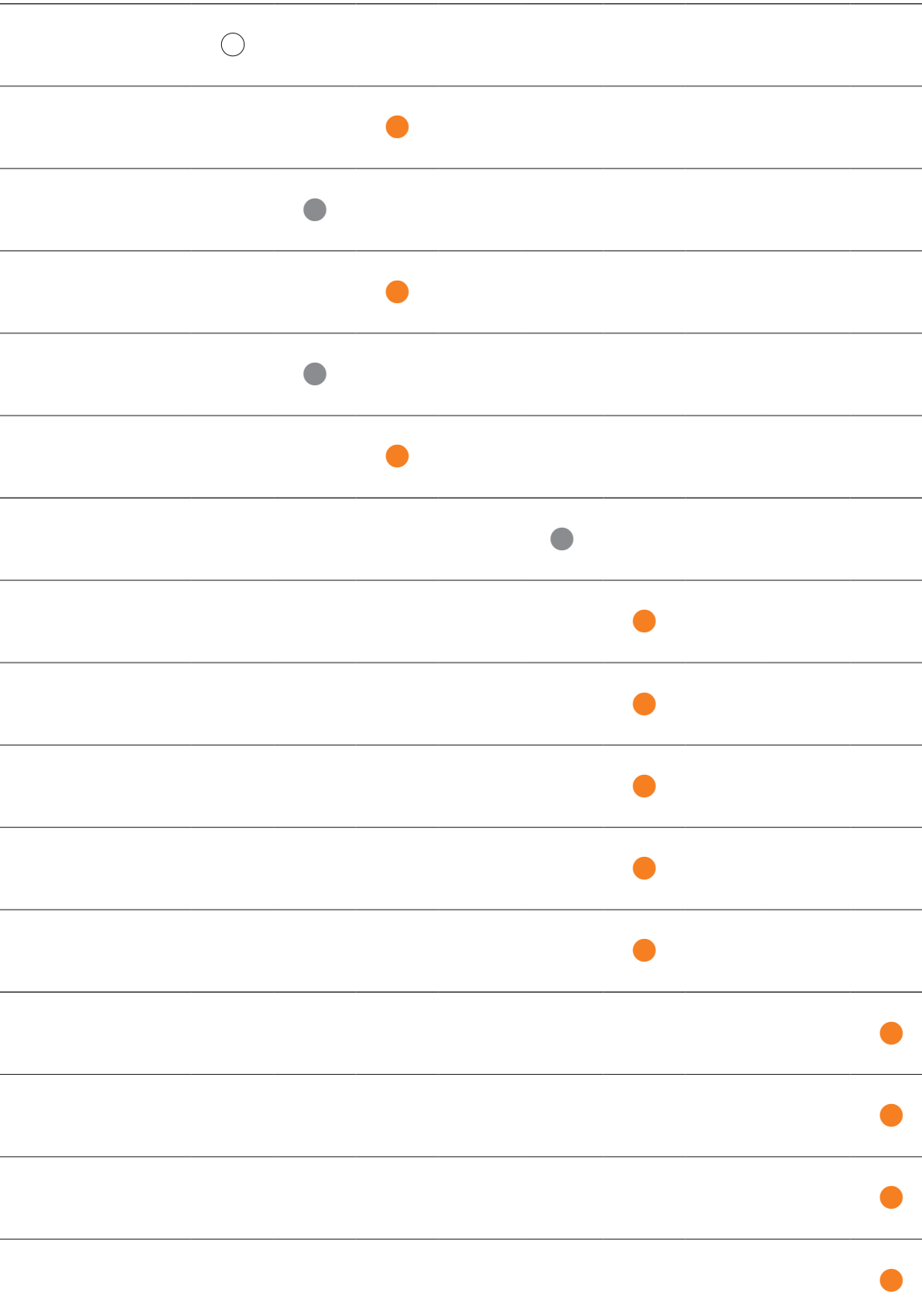

LL 6.35

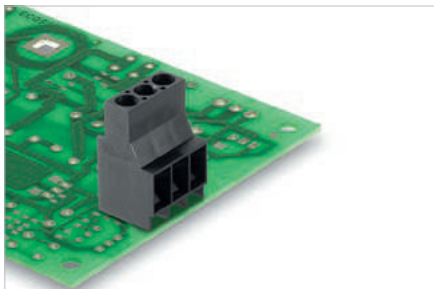

High-power PCB terminal with proven clamping yoke screw connection, 6.35 mm pitch, for conductor cross-sections up to 6 mm<sup>2</sup>.

- UL 600 V approval for unlimited international use in devices.
- Increased derating reserves due to the use of WEMID insulating material.
- Conductor outlet direction of 90°
- Block construction for versions up to 12 poles

Technical data

<b>In compliance with IEC 60664-1 / IEC 61984</b>			
Clamping range, max.	mm <sup>2</sup>	0.18...6	
<b>Solid core H05(07) V-U</b>	mm <sup>2</sup>	<b>0.18...6</b>	
Stranded H07 V-R			
Flexible H05(07) V-K	mm <sup>2</sup>	0.22...4	
Flexible with ferrule	mm <sup>2</sup>	0.5...4	
Ferrule with plastic collar	mm <sup>2</sup>	0.5...2.5	
Stripping length	mm	8	
Screwdriver blade	mm	0.8 x 4.0, PZ 1	
According to norm		DIN 5264	
Tightening torque range	Nm	0.5...0.6	
<b>Rated current, max.</b>	<b>A</b>	<b>32</b>	<b>32</b>
At ambient temperature		20°C	40°C
For conductor cross-section			
Overtoltage category		III	III II
Pollution severity		3	2 2
<b>Rated voltage</b>	<b>V</b>	<b>800</b>	<b>1000 1000</b>
Rated impulse voltage	kV	8	8 8
<b>UL / CUL (Use Group)</b>	<b>B C D</b>	<b>B</b>	<b>C D</b>
<b>Rated voltage</b>	<b>V</b>	<b>600</b>	<b>600 600</b>
<b>Rated current</b>	<b>A</b>	<b>30</b>	<b>30 5</b>
<b>AWG conductor</b>	<b>AWG</b>	<b>26-10</b>	
<b>CSA (Use Group)</b>	<b>B C D</b>	<b>B</b>	<b>C D</b>
Rated voltage	V	600	600 600
Rated current	A	30	30 5
AWG conductor	AWG	26-10	
<b>General data</b>			
Type of insulation material		Wemid (PA)	
UL 94 flammability rating		V-0	
Contact base material		Copper alloy	
Material of contact surface		tinned	
Pin dimensions = d	mm	1.0 x 0.6	
Solder eyelet Ø = D	mm	1.3	
Solder eyelet Ø tolerance	mm	+ 0,1	

Product data

IEC: 1000 V / 32 A / 0.18 - 6 mm<sup>2</sup>  
UL: 600 V / 30 A / AWG 26 - 10



For additional articles and information, refer to [catalog.weidmuller.com](http://catalog.weidmuller.com)

Note:

- Additional colours on request
- Rated current related to rated cross-section & min. No. of poles.
- Wire end ferrule without plastic collar to DIN 46228/1
- Wire end ferrule with plastic collar to DIN 46228/4
- P on drawing = pitch
- Rated data refer only to the component itself. Clearance and creepage distances to other components are to be designed in accordance with the relevant application standards.
- It is necessary to hold the insulating body of the one or two pole terminal when tightening the screw

LL 6.35



Dimensioned drawing

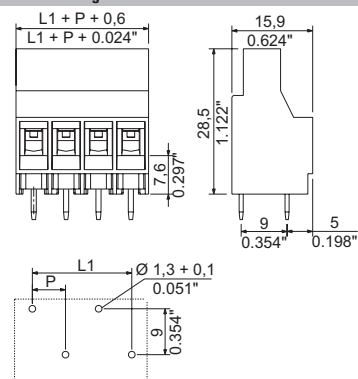

Ordering data

<b>Solder pin length</b>		<b>5 mm</b>		
<b>Colour</b>		<b>Black</b>		
<b>Pitch</b>		<b>6.35 mm</b>		
Pol.	L1	(inch)	Qty.	Order No.
2	6.35	0.250	50	1356830000
3	12.70	0.500	50	1356840000
4	19.05	0.750	50	1356850000
5	25.40	1.000	50	1356870000
6	31.75	1.250	50	1356880000
7	38.10	1.500	50	1356890000
8	44.45	1.750	50	1356900000
9	50.80	2.000	50	1356920000
10	57.15	2.250	50	1356930000
11	63.50	2.500	50	1356940000
12	69.85	2.750	50	1356950000

Accessories

Note: Refer to the Accessories chapter for additional accessories.

Screwdriver		Order No.
	SDIS 0.8X4.0X100	9008400000
	SDS 0.8X4.0X100	9008340000
	SDK PZ1	9008530000

Representative deratings curve

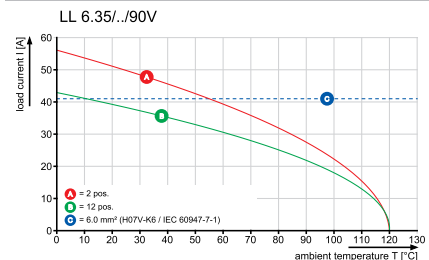

J

6.35

90°

6 mm<sup>2</sup>



LU 10.16/./90

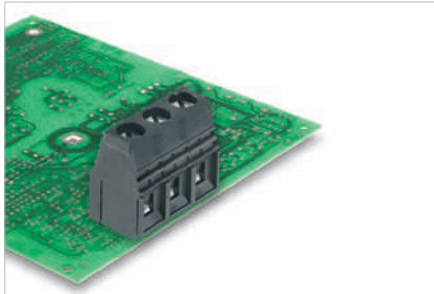

High-power PCB Terminal with clamping yoke screw connection, in 10.16 mm pitch for wire cross-sections up to 16 mm<sup>2</sup> (AWG 6).

- Increased derating reserves because WEMID insulating material is used.
- Wire outlet direction: 90° version.
- 2- and 3-pole block construction can be aligned together for higher pole counts.

Technical data

In compliance with IEC 60664-1 / IEC 61984

Clamping range, max.	mm <sup>2</sup>	0.14...16	
<b>Solid core H05(07) V-U</b>	<b>mm<sup>2</sup></b>	<b>0.5...16</b>	
Stranded H07 V-R		...16	
Flexible H05(07) V-K	mm <sup>2</sup>	0.5...16	
Flexible with ferrule	mm <sup>2</sup>	2.5...10	
Ferrule with plastic collar	mm <sup>2</sup>	2.5...10	
Stripping length	mm	12	
Screwdriver blade	mm	1.0 x 5.5	
		According to norm DIN 5264	
Tightening torque range	Nm	1.2...1.5	
<b>Rated current, max.</b>	<b>A</b>	<b>76</b>	<b>76</b>
At ambient temperature		20°C	40°C
For conductor cross-section			
Overvoltage category		III	III II
Pollution severity		3	2 2
<b>Rated voltage</b>	<b>V</b>	<b>690</b>	<b>690 1000</b>
Rated impulse voltage	kV	6	6 4
<b>UL / CUL (Use Group)</b>	<b>B C D</b>	<b>B</b>	<b>C D</b>

<b>Rated voltage</b>	<b>V</b>	<b>300</b>	<b>150</b>	<b>600</b>
<b>Rated current</b>	<b>A</b>	<b>65</b>	<b>65</b>	<b>5</b>
<b>AWG conductor</b>	<b>AWG</b>	<b>26-6</b>		
<b>CSA (Use Group)</b>	<b>B C D</b>	<b>B</b>	<b>C</b>	<b>D</b>
Rated voltage	V	300	150	300
Rated current	A	65	65	10
AWG conductor	AWG	22-6		

<b>General data</b>	
Type of insulation material	Wemid (PA)
UL 94 flammability rating	V-0
Contact base material	E-Cu
Material of contact surface	tinned
Pin dimensions = d	mm 1.2 x 1.2
Solder eyelet Ø = D	mm 1.6
Solder eyelet Ø tolerance	mm + 0,1

Product data

IEC: 1000 V / 76 A / 0.5 - 16 mm<sup>2</sup>  
 UL: 300 V / 65 A / AWG 26 - 6



For additional articles and information, refer to [catalog.weidmueller.com](http://catalog.weidmueller.com)

Note:

- Additional colours on request
- Rated current related to rated cross-section & min. No. of poles.
- Wire end ferrule without plastic collar to DIN 46228/1
- Wire end ferrule with plastic collar to DIN 46228/4
- P on drawing = pitch
- Rated data refer only to the component itself. Clearance and creepage distances to other components are to be designed in accordance with the relevant application standards.

LU 10.16/./90



Dimensioned drawing

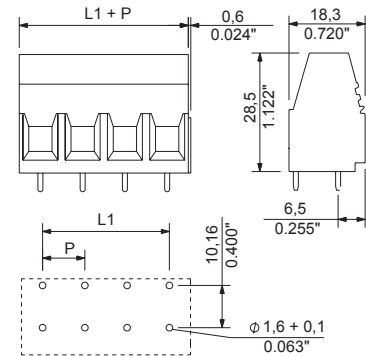

Ordering data

<b>Solder pin length</b>		<b>4.5 mm</b>		
<b>Colour</b>		<b>Black</b>		
<b>Pitch</b>		<b>10.16 mm</b>		
Pol.	L1	(inch)	Qty.	Order No.
2	10.16	0.400	20	1934140000
3	20.32	0.800	20	1921450000
4	30.48	1.200	20	1226220000
5	40.64	1.600	20	1226230000
6	50.80	2.000	20	1226240000
7	60.96	2.400	20	1226250000
8	71.12	2.800	20	1226260000
9	81.28	3.200	20	1226270000
10	91.44	3.600	20	1226280000

Accessories

Note: Refer to the Accessories chapter for additional accessories.

<b>Screwdriver</b>		<b>Order No.</b>
	SDS 1.0X5.5X150	9008350000
	SDIS 1.0X5.5X125	9008410000
<b>Crosshead screwdriver</b>		
	SDK PZ2	9008540000
	SDIK PZ2	9008890000
<b>Identification systems</b>		
	DEK 5 NEUTRAL	0473360000
	DEK 5/5 MC NE WS	1609801044

Representative deratings curve

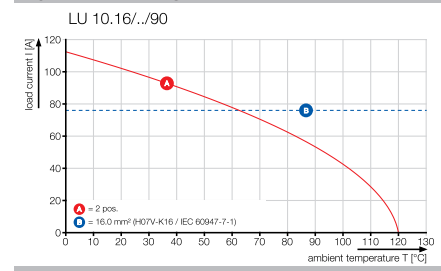



LUP 10.16/./90

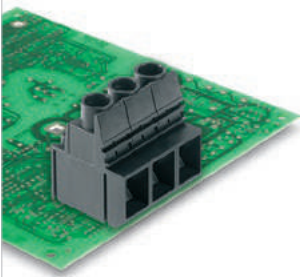

High-power PCB terminal with clamping yoke screw connection, in 10.16 mm pitch for wire cross-sections up to 16 mm<sup>2</sup> (AWG 6).

- Increased derating reserves through the use of WEMID insulating material.
- Conductor outlet direction: 90°
- With integrated test point for test plug PS 2.0.

Technical data

In compliance with IEC 60664-1 / IEC 61984			
Clamping range, max.	mm <sup>2</sup>	0.13...16	
<b>Solid core H05(07) V-U</b>	<b>mm<sup>2</sup></b>	<b>0.5...16</b>	
Stranded H07 V-R		...16	
Flexible H05(07) V-K	mm <sup>2</sup>	0.5...16	
Flexible with ferrule	mm <sup>2</sup>	2.5...10	
Ferrule with plastic collar	mm <sup>2</sup>	2.5...10	
Stripping length	mm	12	
Screwdriver blade	mm	1.0 x 5.5, PZ 2	
According to norm		DIN 5264	
Tightening torque range	Nm	1.2...1.5	
<b>Rated current, max.</b>	<b>A</b>	<b>76</b>	<b>72</b>
At ambient temperature	20°C		40°C
For conductor cross-section			
Overvoltage category		III	III II
Pollution severity		3	2 2
<b>Rated voltage</b>	<b>V</b>	<b>800</b>	<b>1000 1000</b>
Rated impulse voltage	kV	8	8 6
<b>UL / CUL (Use Group)</b>		<b>B</b>	<b>C D</b>
<b>Rated voltage</b>	<b>V</b>	<b>300</b>	<b>300 600</b>
<b>Rated current</b>	<b>A</b>	<b>58</b>	<b>58 5</b>
<b>AWG conductor</b>	<b>AWG</b>		<b>26-6</b>
<b>CSA (Use Group)</b>		<b>B</b>	<b>C D</b>
Rated voltage	V	300	300 600
Rated current	A	58	58 5
AWG conductor	AWG	22-6	
General data			
Type of insulation material		Wemid (PA)	
UL 94 flammability rating		V-0	
Contact base material		E-Cu	
Material of contact surface		tinned	
Pin dimensions = d	mm	1.2 x 1.2	
Solder eyelet Ø = D	mm	1.6	
Solder eyelet Ø tolerance	mm	+ 0,1	

Product data

IEC: 1000 V / 76 A / 0.5 - 16 mm<sup>2</sup>  
 UL: 300 V / 58 A / AWG 26 - 6



For additional articles and information, refer to [catalog.weidmueller.com](http://catalog.weidmueller.com)

Note:

- Additional colours on request
- Rated current related to rated cross-section & min. No. of poles.
- Wire end ferrule without plastic collar to DIN 46228/1
- Wire end ferrule with plastic collar to DIN 46228/4
- The data given under CSA relates to a cUL approval - E60693
- P on drawing = pitch
- Rated data refer only to the component itself. Clearance and creepage distances to other components are to be designed in accordance with the relevant application standards.
- The test point can only be used as potential-pickup point.

LUP 10.16/./90



Dimensioned drawing

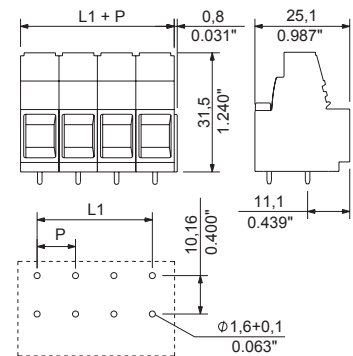

Accessories

Note: Refer to the Accessories chapter for additional accessories.

Screwdriver		Order No.
	SDS 1.0X5.5X150	9008350000
	SDIS 1.0X5.5X125	9008410000
Crosshead screwdriver		
	SDK PZ2	9008540000
	SDIK PZ2	9008890000
Test plug		
	PS 2.0 MC	0310000000
Identification systems		
	DEK 5 NEUTRAL	0473360000
	DEK 5/5 MC NE WS	1609801044

Ordering data

Solder pin length		5 mm		
Colour		Black		
Pitch 10.16 mm				
Pol.	L1	(inch)	Qty.	Order No.
2	10.16	0.400	20	2014050000
3	20.32	0.800	20	2014060000
4	30.48	1.200	20	2014090000
5	40.64	1.600	20	2014140000
6	50.80	2.000	20	2014150000
7	60.96	2.400	20	2014160000
8	71.12	2.800	20	2014170000
9	81.28	3.200	20	2014180000

Representative deratings curve

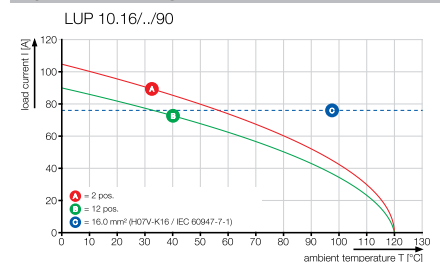

LUP 10.16/./90V

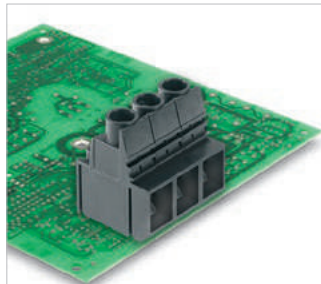

High-performance PCB terminal block with clamping yoke screw connection, in 10.16 mm pitch for wire cross-sections up to 16 mm<sup>2</sup> (AWG 6).

- UL approval 600 V
- Increased derating reserves through the use of WEMID insulating material.
- Wire outlet direction: 90°
- With integrated test point for test plug PS 2.0.

Technical data

<b>In compliance with IEC 60664-1 / IEC 61984</b>			
Clamping range, max.	mm <sup>2</sup>	0.13...16	
<b>Solid core H05(07) V-U</b>	<b>mm<sup>2</sup></b>	<b>0.5...16</b>	
Stranded H07 V-R		...16	
Flexible H05(07) V-K	mm <sup>2</sup>	0.5...16	
Flexible with ferrule	mm <sup>2</sup>	2.5...10	
Ferrule with plastic collar	mm <sup>2</sup>	2.5...10	
Stripping length	mm	12	
Screwdriver blade	mm	1.0 x 5.5, PZ 2	
According to norm		DIN 5264	
Tightening torque range	Nm	1.2...1.5	
<b>Rated current, max.</b>	<b>A</b>	<b>76</b>	<b>72</b>
At ambient temperature		20°C	40°C
For conductor cross-section			
Overvoltage category		III	III II
Pollution severity		3	2 2
<b>Rated voltage</b>	<b>V</b>	<b>800</b>	<b>1000 1000</b>
Rated impulse voltage	kV	8	8 6
<b>UL / CUL (Use Group)</b>		<b>B</b>	<b>C D</b>
<b>Rated voltage</b>	<b>V</b>	<b>600</b>	<b>600 600</b>
<b>Rated current</b>	<b>A</b>	<b>51</b>	<b>51 5</b>
<b>AWG conductor</b>	<b>AWG</b>		<b>22-6</b>
<b>CSA (Use Group)</b>		<b>B</b>	<b>C D</b>
Rated voltage	V	600	600 600
Rated current	A	51	51 5
AWG conductor	AWG		22-6
<b>General data</b>			
Type of insulation material		Wemid (PA)	
UL 94 flammability rating		V-0	
Contact base material		E-Cu	
Material of contact surface		tinned	
Pin dimensions = d	mm	1.2 x 1.2	
Solder eyelet Ø = D	mm	1.6	
Solder eyelet Ø tolerance	mm	+ 0,1	

Product data

IEC: 1000 V / 76 A / 0.5 - 16 mm<sup>2</sup>  
UL: 600 V / 51 A / AWG 22 - 6



For additional articles and information, refer to [catalog.weidmueller.com](http://catalog.weidmueller.com)

Note:

- Additional colours on request
- Rated current related to rated cross-section & min. No. of poles.
- Wire end ferrule without plastic collar to DIN 46228/1
- Wire end ferrule with plastic collar to DIN 46228/4
- The data given under CSA relates to a cUL approval - E60693
- P on drawing = pitch
- Rated data refer only to the component itself. Clearance and creepage distances to other components are to be designed in accordance with the relevant application standards.

LUP 10.16/./90V



Dimensioned drawing

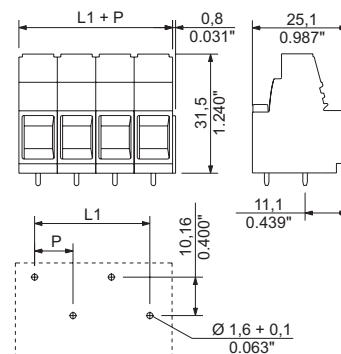

Accessories

Note: Refer to the Accessories chapter for additional accessories.

<b>Screwdriver</b>		<b>Order No.</b>
	SDS 1.0X5.5X150	<b>9008350000</b>
	SDIS 1.0X5.5X125	<b>9008410000</b>
<b>Crosshead screwdriver</b>		
	SDK PZ2	<b>9008540000</b>
	SDIK PZ2	<b>9008890000</b>
<b>Test plug</b>		
	PS 2.0 MC	<b>0310000000</b>
<b>Identification systems</b>		
	DEK 5 NEUTRAL	<b>0473360000</b>
	DEK 5/5 MC NE WS	<b>1609801044</b>

Ordering data

<b>Solder pin length</b>	5 mm			
<b>Colour</b>	Black			
<b>Pitch</b>	10.16 mm			
<b>Pol.</b>	<b>L1</b>	<b>(inch)</b>	<b>Qty.</b>	<b>Order No.</b>
2	10.16	0.400	20	<b>2012810000</b>
3	20.32	0.800	20	<b>2012890000</b>
4	30.48	1.200	20	<b>2013870000</b>
5	40.64	1.600	20	<b>2013880000</b>
6	50.80	2.000	20	<b>2013890000</b>
7	60.96	2.400	20	<b>2013900000</b>
8	71.12	2.800	20	<b>2013910000</b>
9	81.28	3.200	20	<b>2013920000</b>

Representative deratings curve

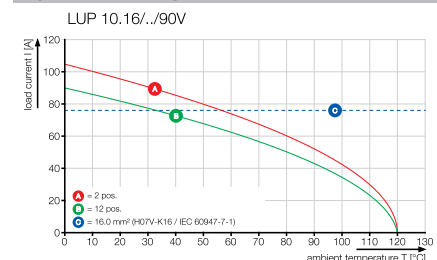

LUP 12.7../90

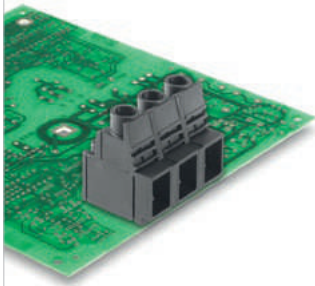

High-performance PCB terminal block with clamping yoke screw connection, in 12.70 mm pitch for wire cross-sections up to 16 mm<sup>2</sup>.

- UL approval 600 V
- Increased derating reserves through the use of WEMID insulating material.
- Wire outlet direction: 90°
- With integrated test point for test plug PS 2.0.

Technical data

In compliance with IEC 60664-1 / IEC 61984			
Clamping range, max.	mm <sup>2</sup>	0.13...16	
<b>Solid core H05(07) V-U</b>	<b>mm<sup>2</sup></b>	<b>0.5...16</b>	
Stranded H07 V-R		...16	
Flexible H05(07) V-K	mm <sup>2</sup>	0.5...16	
Flexible with ferrule	mm <sup>2</sup>	2.5...10	
Ferrule with plastic collar	mm <sup>2</sup>	2.5...10	
Stripping length	mm	12	
Screwdriver blade	mm	1.0 x 5.5, PZ 2	
According to norm		DIN 5264	
Tightening torque range	Nm	1.2...1.5	
<b>Rated current, max.</b>	<b>A</b>	<b>76</b>	<b>76</b>
At ambient temperature	20°C	40°C	
For conductor cross-section			
Overvoltage category		III	III II
Pollution severity		3	2 2
<b>Rated voltage</b>	<b>V</b>	<b>1000</b>	<b>1000 1000</b>
Rated impulse voltage	kV	8	8 6
<b>UL / CUL (Use Group)</b>		<b>B</b>	<b>C D</b>
<b>Rated voltage</b>	<b>V</b>	<b>600</b>	<b>600</b>
<b>Rated current</b>	<b>A</b>	<b>65</b>	<b>65</b>
<b>AWG conductor</b>	<b>AWG</b>	<b>22-6</b>	
<b>CSA (Use Group)</b>		<b>B</b>	<b>C D</b>
Rated voltage	V	600	600
Rated current	A	65	65
AWG conductor	AWG	22-6	
General data			
Type of insulation material		Wemid (PA)	
UL 94 flammability rating		V-0	
Contact base material		E-Cu	
Material of contact surface		tinned	
Pin dimensions = d	mm	1.2 x 1.2	
Solder eyelet Ø = D	mm	1.6	
Solder eyelet Ø tolerance	mm	+ 0,1	

Product data

IEC: 1000 V / 76 A / 0.5 - 16 mm<sup>2</sup>  
 UL: 600 V / 65 A / AWG 22 - 6



For additional articles and information, refer to [catalog.weidmuller.com](http://catalog.weidmuller.com)

Note:

- Additional colours on request
- Rated current related to rated cross-section & min. No. of poles.
- Wire end ferrule without plastic collar to DIN 46228/1
- Wire end ferrule with plastic collar to DIN 46228/4
- The data given under CSA relates to a cUL approval - E60693
- P on drawing = pitch
- Rated data refer only to the component itself. Clearance and creepage distances to other components are to be designed in accordance with the relevant application standards.

LUP 12.7../90



Dimensioned drawing

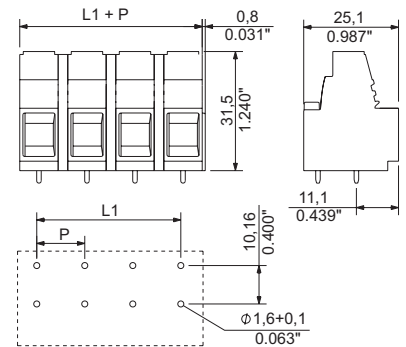

Accessories

Note: Refer to the Accessories chapter for additional accessories.

Screwdriver		Order No.
	SDS 1.0X5.5X150	9008350000
	SDIS 1.0X5.5X125	9008410000
Crosshead screwdriver		
	SDK PZ2	9008540000
	SDIK PZ2	9008890000
Test plug		
	PS 2.0 MC	0310000000
Identification systems		
	DEK 5 NEUTRAL	0473360000
	DEK 5/5 MC NE WS	1609801044

Ordering data

Solder pin length		5 mm		
Colour		Black		
Pitch 12.70 mm				
Pol.	L1	(inch)	Qty.	Order No.
2	12.70	0.500	20	2014360000
3	25.40	1.000	20	2014380000
4	38.10	1.500	20	2014400000
5	50.80	2.000	20	2014420000
6	63.50	2.500	20	2014590000
7	76.20	3.000	20	2014610000
8	88.90	3.250	20	2014760000
9	101.60	4.000	20	2014900000

Representative deratings curve

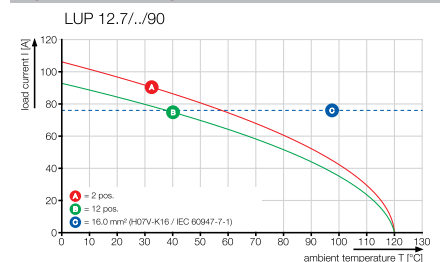

LX 15.00/./90

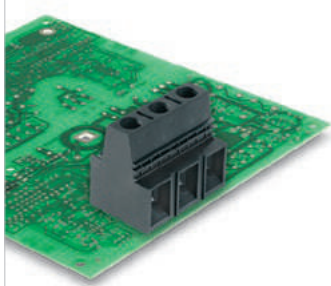

High-power PCB Terminal with clamping yoke screw connection, in 15.00 mm pitch for wire cross-sections up to 25 mm<sup>2</sup> (AWG 4).

- UL 600 V approval.
- Increased derating reserves because WEMID insulating material is used.
- Wire outlet direction: 90°.
- With integrated test point for PS 2.0 test plug.
- Versions up to 8 poles have block construction.
- Available with and without mounting flange.

Product data

IEC: 1000 V / 101 A / 1.5 - 25 mm<sup>2</sup>  
 UL: 600 V / 85 A / AWG 16 - 4



For additional articles and information, refer to [catalog.weidmueller.com](http://catalog.weidmueller.com)

Note:

- Additional colours on request
- Rated current related to rated cross-section & min. No. of poles.
- Wire end ferrule without plastic collar to DIN 46228/1
- Wire end ferrule with plastic collar to DIN 46228/4
- P on drawing = pitch
- Rated data refer only to the component itself. Clearance and creepage distances to other components are to be designed in accordance with the relevant application standards.
- The test point can only be used as potential-pickup point.

LX 15.00/./90

with test point



Dimensioned drawing

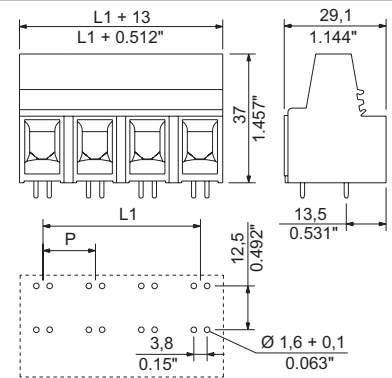

Technical data

In compliance with IEC 60664-1 / IEC 61984

Clamping range, max.	mm <sup>2</sup>	1.31...25
<b>Solid core H05(07) V-U</b>	<b>mm<sup>2</sup></b>	<b>1.5...16</b>
Stranded H07 V-R	mm <sup>2</sup>	6...25
Flexible H05(07) V-K	mm <sup>2</sup>	1.5...25
Flexible with ferrule	mm <sup>2</sup>	1.5...16
Ferrule with plastic collar	mm <sup>2</sup>	1.5...16
Stripping length	mm	16
Screwdriver blade	mm	1.0 x 5.5
According to norm		DIN 5264
Tightening torque range	Nm	2.4...4
<b>Rated current, max.</b>	<b>A</b>	<b>101 101</b>
At ambient temperature	20°C	40°C
For conductor cross-section		
Overvoltage category		III III II
Pollution severity		3 2 2
<b>Rated voltage</b>	<b>V</b>	<b>1000 1000 1000</b>
Rated impulse voltage	kV	8 8 6
<b>UL / CUL (Use Group)</b>	<b>B C D</b>	<b>B C D</b>

<b>Rated voltage</b>	<b>V</b>	<b>600 600 600</b>
<b>Rated current</b>	<b>A</b>	<b>85 85 5</b>
<b>AWG conductor</b>	<b>AWG</b>	<b>16-4</b>
<b>CSA (Use Group)</b>	<b>B C D</b>	<b>B C D</b>
Rated voltage	V	600 600 600
Rated current	A	85 85 5
AWG conductor	AWG	16-4

<b>General data</b>		
Type of insulation material		Wemid (PA)
UL 94 flammability rating		V-0
Contact base material		E-Cu
Material of contact surface		tinned
Pin dimensions = d	mm	1.2 x 1.2
Solder eyelet Ø = D	mm	1.6
Solder eyelet Ø tolerance	mm	+ 0,1

Accessories

Note: Refer to the Accessories chapter for additional accessories.

<b>Screwdriver</b>		<b>Order No.</b>
	SDS 1.2X6.5X150	<b>9009010000</b>
	SDIS 1.2X6.5X150	<b>9008420000</b>
<b>Crosshead screwdriver</b>		
	SDK PZ2	<b>9008540000</b>
	SDIK PZ2	<b>9008890000</b>
<b>Test plug</b>		
	PS 2.0 MC	<b>0310000000</b>
<b>Identification systems</b>		
	DEK 5 NEUTRAL	<b>0473360000</b>
	DEK 5/5 MC NE WS	<b>1609801044</b>

Ordering data

<b>Solder pin length</b>	4.5 mm			
<b>Colour</b>	Black			
<b>Pitch</b>	15.00 mm			
<b>Pol.</b>	<b>L1</b>	<b>(inch)</b>	<b>Qty.</b>	<b>Order No.</b>
1	0.00	0.000	20	<b>1226460000</b>
2	15.00	0.591	20	<b>1226470000</b>
3	30.00	1.181	20	<b>1174720000</b>
4	45.00	1.772	20	<b>1226480000</b>
5	60.00	2.362	20	<b>1226490000</b>
6	75.00	2.953	10	<b>1226500000</b>
7	90.00	3.543	10	<b>1226510000</b>
8	105.00	4.134	10	<b>1921480000</b>

Representative deratings curve

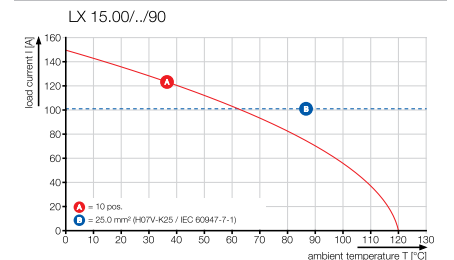

**LXB 15.00../90**

with fixing flange and test point



Dimensioned drawing

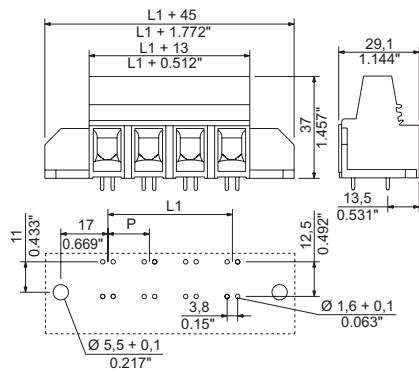

**Ordering data**

Solder pin length		4.5 mm			
Colour		Black			
Pitch		15.00 mm			
Pol.	L1	(inch)	Qty.	Order No.	
2	15.00	0.591	20	1226520000	
3	30.00	1.181	20	1226530000	
4	45.00	1.772	20	1226540000	
5	60.00	2.362	20	1226550000	
6	75.00	2.953	10	1226560000	
7	90.00	3.543	10	1226570000	
8	105.00	4.134	10	1226580000	

**LXBL 15.00../90**

with fixing flange left and test point



Dimensioned drawing

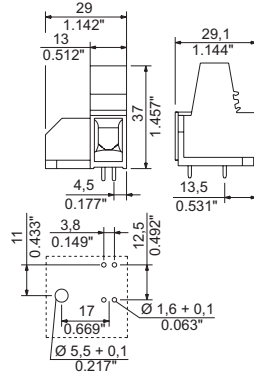

**Ordering data**

Solder pin length		4.5 mm			
Colour		Black			
Pitch		15.00 mm			
Pol.	L1	(inch)	Qty.	Order No.	
1	0.00	0.000	20	1226590000	

**Additional deratings curves**

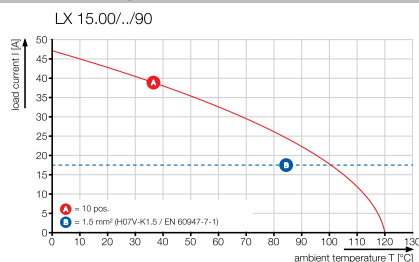

LXXX 15.00/./90

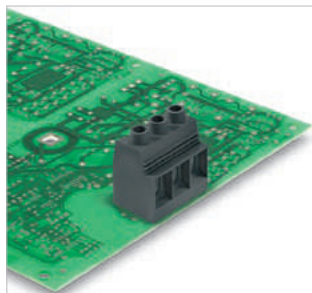

High-power PCB Terminal with clamping yoke screw connection, in 15.00 mm pitch for wire cross-sections up to 50 mm<sup>2</sup> (AWG 1).

- UL 600 V approval for unlimited international usage in devices.
- Increased derating reserves because WEMID insulating material is used.
- Wire outlet direction of 90°.
- With integrated test point for PS 2.0 test plug.
- Versions up to 8 poles have block construction.
- Available with and without mounting flange.

Technical data

<b>In compliance with IEC 60664-1 / IEC 61984</b>			
Clamping range, max.	mm <sup>2</sup>	0.5...50	
<b>Solid core H05(07) V-U</b>	<b>mm<sup>2</sup></b>	<b>0.5...16</b>	
Stranded H07 V-R	mm <sup>2</sup>	6...50	
Flexible H05(07) V-K	mm <sup>2</sup>	0.5...35	
Flexible with ferrule	mm <sup>2</sup>	0.5...35	
Ferrule with plastic collar	mm <sup>2</sup>	0.5...35	
Stripping length	mm	18	
Screwdriver blade	mm	1.2 x 6.5	
According to norm		DIN 5264	
Tightening torque range	Nm	2.5...4	
<b>Rated current, max.</b>		<b>150</b>	<b>150</b>
At ambient temperature	20°C	40°C	
For conductor cross-section			
Overvoltage category		III	III II
Pollution severity		3	2 2
<b>Rated voltage</b>	<b>V</b>	<b>1000</b>	<b>1000 1000</b>
Rated impulse voltage	kV	8	8 8
<b>UL / CUL (Use Group)</b>		<b>B</b>	<b>C D</b>
<b>Rated voltage</b>	<b>V</b>	<b>600</b>	<b>600 600</b>
<b>Rated current</b>	<b>A</b>	<b>127</b>	<b>127 5</b>
<b>AWG conductor</b>	<b>AWG</b>		<b>20-1</b>
<b>CSA (Use Group)</b>		<b>B</b>	<b>C D</b>
Rated voltage	V	600	600 600
Rated current	A	127	127 5
AWG conductor	AWG		20-1
<b>General data</b>			
Type of insulation material		Wemid (PA)	
UL 94 flammability rating		V-0	
Contact base material		Copper alloy	
Material of contact surface		tinned	
Pin dimensions = d	mm	1.2 x 1.2	
Solder eyelet Ø = D	mm	1.6	
Solder eyelet Ø tolerance	mm	+ 0,1	

Product data

IEC: 1000 V / 150 A / 0.5 - 50 mm<sup>2</sup>  
 UL: 600 V / 127 A / AWG 20 - 1



For additional articles and information, refer to [catalog.weidmuller.com](http://catalog.weidmuller.com)

Note:

- Additional colours on request
- Rated current related to rated cross-section & min. No. of poles.
- Wire end ferrule without plastic collar to DIN 46228/1
- Wire end ferrule with plastic collar to DIN 46228/4
- P on drawing = pitch
- Rated data refer only to the component itself. Clearance and creepage distances to other components are to be designed in accordance with the relevant application standards.
- IP 20 from 16 mm<sup>2</sup> to 50 mm<sup>2</sup>
- The test point can only be used as potential-pickup point.
- Wire-end ferrules are mandatory for stranded wires with more than 19 strands.

LXXX 15.00/./90

with test point



Dimensioned drawing

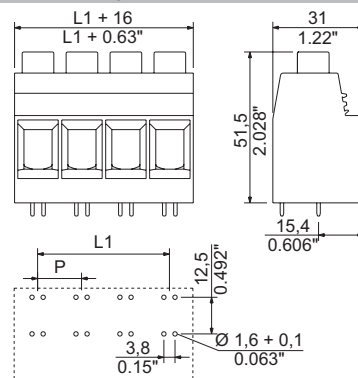

Ordering data

<b>Solder pin length</b>		4.5 mm		
<b>Colour</b>		Black		
<b>Pitch</b>		15.00 mm		
Pol.	L1	(inch)	Qty.	Order No.
1	0.00	0.000	20	1047120000
2	15.00	0.591	20	1047130000
3	30.00	1.181	10	1047140000
4	45.00	1.772	10	1047150000
5	60.00	2.363	16	1386250000
6	75.00	2.954	12	1386400000
7	90.00	3.545	12	1386550000
8	105.00	4.136	10	1386700000
9	120.00	4.727	8	1386850000

Accessories

Note: Refer to the Accessories chapter for additional accessories.

<b>Screwdriver</b>		<b>Order No.</b>
	SDS 1.2X6.5X150	9009010000
	SDIS 1.2X6.5X150	9008420000
<b>Crosshead screwdriver</b>		
	SDK PZ2	9008540000
	SDIK PZ2	9008890000
<b>Test plug</b>		
	PS 2.0 MC	0310000000
<b>Identification systems</b>		
	DEK 5 NEUTRAL	0473360000
	DEK 5/5 MC NE WS	1609801044

Representative deratings curve

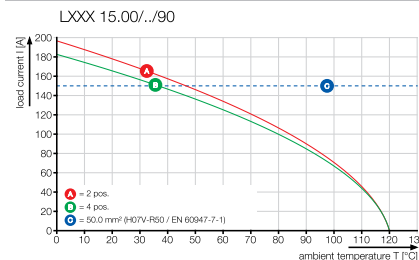

LXXX 15.00../90F

with fixing flange and test point



Dimensioned drawing

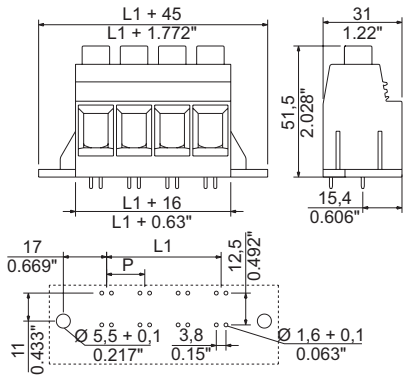

Ordering data

Solder pin length		4.5 mm	
Colour		Black	
Pitch		15.00 mm	
Pol.	L1	(inch)	Qty. Order No.
1	0.00	0.000	20 1047280000
2	15.00	0.591	20 1047290000
3	30.00	1.181	10 1047300000
4	45.00	1.772	10 1047310000
5	60.00	2.363	12 1386290000
6	75.00	2.954	10 1386440000
7	90.00	3.545	8 1386590000
8	105.00	4.136	8 1386740000
9	120.00	4.727	8 1386890000

LXXX 15.00../90FL

with fixing flange left and test point



Dimensioned drawing

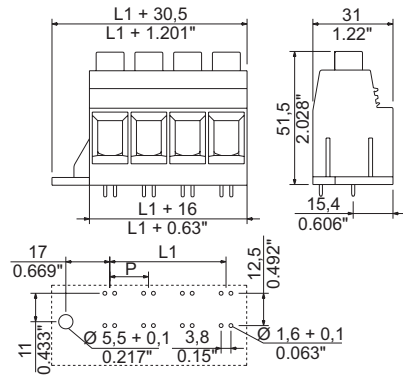

Ordering data

Solder pin length		4.5 mm	
Colour		Black	
Pitch		15.00 mm	
Pol.	L1	(inch)	Qty. Order No.
1	0.00	0.000	20 1047440000
2	15.00	0.591	20 1047450000
3	30.00	1.181	10 1047460000
4	45.00	1.772	10 1047470000
5	60.00	2.363	12 1386330000
6	75.00	2.954	12 1386480000
7	90.00	3.545	10 1386630000
8	105.00	4.136	8 1386780000
9	120.00	4.727	8 1386930000

LXXX 15.00../90FR

with fixing flange right and test point



Dimensioned drawing

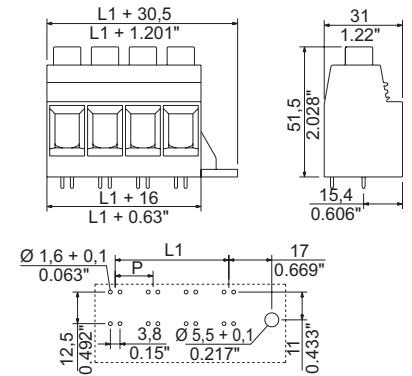

Ordering data

Solder pin length		4.5 mm	
Colour		Black	
Pitch		15.00 mm	
Pol.	L1	(inch)	Qty. Order No.
1	0.00	0.000	20 1047600000
2	15.00	0.591	20 1047610000
3	30.00	1.181	10 1047620000
4	45.00	1.772	10 1047630000
5	60.00	2.363	12 1386370000
6	75.00	2.954	12 1386520000
7	90.00	3.545	10 1386670000
8	105.00	4.136	8 1386820000
9	120.00	4.727	8 1386970000

J

Additional deratings curves

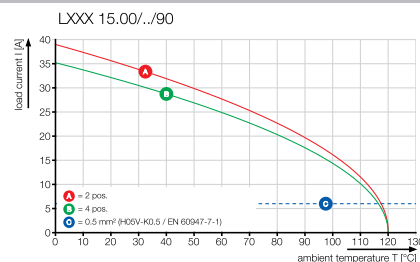
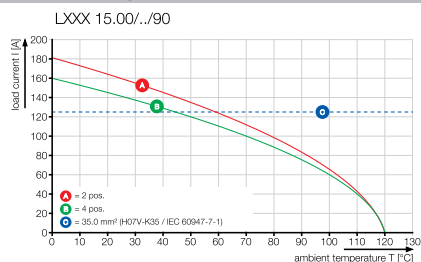

LLF 7.50/./90

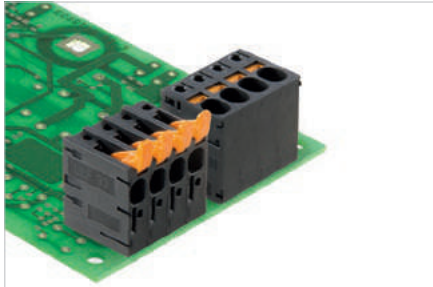

High-performance PCB terminal with PUSH IN connection system for wire cross-sections up to 6 mm<sup>2</sup>.

- Fast connection without tools thanks to an operating lever for opening the contact point, or direct insertion
- Securely closed contact point: with the "Connection Safety Concept" the conductor is always clamped securely
- Integrated test point for test plug PS 2.0
- Central tip test point for test probes on the upper side of the terminal
- Increased derating reserves through the use of WEMID insulating material
- Wire outlet direction: 90° version

Technical data

In compliance with IEC 60664-1 / IEC 61984

Clamping range, max.	mm <sup>2</sup>	0.25...6	
<b>Solid core H05(07) V-U</b>	<b>mm<sup>2</sup></b>	<b>0.5...6</b>	
Stranded H07 V-R			
Flexible H05(07) V-K	mm <sup>2</sup>	0.5...6	
Flexible with ferrule	mm <sup>2</sup>	0.25...6	
Ferrule with plastic collar	mm <sup>2</sup>	0.25...6	
Stripping length	mm	12	
Screwdriver blade	mm		

According to norm

Tightening torque range			
<b>Rated current, max.</b>	<b>A</b>	<b>41</b>	<b>41</b>
At ambient temperature		20°C	40°C

For conductor cross-section			
Overtoltage category		III	III
Pollution severity		3	2
		2	2

<b>Rated voltage</b>	<b>V</b>	<b>600</b>	<b>600</b>	<b>600</b>
Rated impulse voltage	kV	6	6	6

UL / CUL (Use Group)

<b>Rated voltage</b>	<b>V</b>	<b>300</b>	<b>150</b>	<b>300</b>
<b>Rated current</b>	<b>A</b>	<b>35</b>	<b>35</b>	<b>10</b>
<b>AWG conductor</b>	<b>AWG</b>	<b>24-8</b>		

CSA (Use Group)

<b>Rated voltage</b>	<b>V</b>	<b>300</b>	<b>1000</b>	<b>300</b>
<b>Rated current</b>	<b>A</b>	<b>35</b>	<b>35</b>	<b>10</b>
<b>AWG conductor</b>	<b>AWG</b>	<b>24-8</b>		

General data

Type of insulation material		Wemid (PA)
UL 94 flammability rating		V-0
Contact base material		E-Cu
Material of contact surface		tinned
Pin dimensions = d	mm	d = 1.5
Solder eyelet Ø = D	mm	2
Solder eyelet Ø tolerance	mm	+ 0,1

Product data

IEC: 600 V / 41 A / 0.5 - 6 mm<sup>2</sup>  
UL: 300 V / 35 A / AWG 24 - 8



For additional articles and information, refer to [catalog.weidmueller.com](http://catalog.weidmueller.com)

Note:

- Additional colours on request
- Rated current related to rated cross-section & min. No. of poles.
- Wire end ferrule without plastic collar to DIN 46228/1
- Wire end ferrule with plastic collar to DIN 46228/4
- P on drawing = pitch
- Rated data refer only to the component itself. Clearance and creepage distances to other components are to be designed in accordance with the relevant application standards.
- The test point can only be used as potential-pickup point.

LLF 7.50/./90



Dimensioned drawing

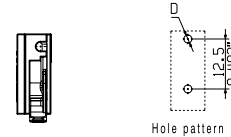
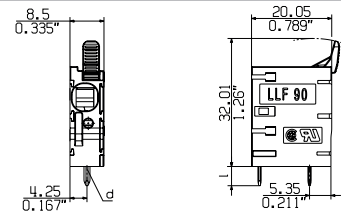

Ordering data

Solder pin length	5 mm			
Colour	Black			
Pitch	7.50 mm			
Pol.	L1	(inch)	Qty.	Order No.
1	0.00	0.000	200	2471520000

Accessories

Note: Refer to the Accessories chapter for additional accessories.

Screwdriver		Order No.
	SDIS 0.5X3.0X100	9008380000
	SDS 0.5X3.0X80	9008320000
Test plug		
	PS 2.0 MC	0310000000

Representative deratings curve

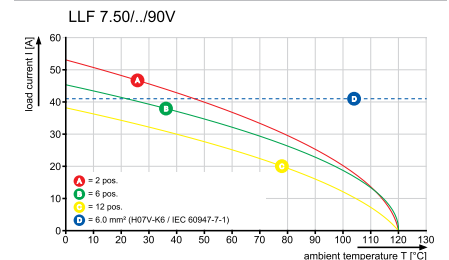



LLF 7.50/.. /90V

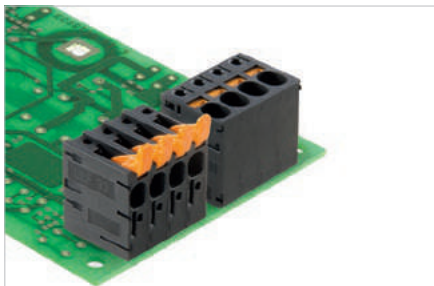

High-performance PCB terminal with PUSH IN connection system for wire cross-sections up to 6 mm<sup>2</sup>.

- Fast connection without tools thanks to an operating lever for opening the contact point, or direct insertion
- Securely closed contact point: with the "Connection Safety Concept" the conductor is always clamped securely
- Integrated test point for test plug PS 2.0
- Central tip test point for test probes on the upper side of the terminal
- Increased derating reserves through the use of WEMID insulating material
- Wire outlet direction: 90° version

Technical data

In compliance with IEC 60664-1 / IEC 61984			
Clamping range, max.	mm <sup>2</sup>	0.25...6	
<b>Solid core H05(07) V-U</b>	<b>mm<sup>2</sup></b>	<b>0.5...6</b>	
Stranded H07 V-R			
Flexible H05(07) V-K	mm <sup>2</sup>	0.5...6	
Flexible with ferrule	mm <sup>2</sup>	0.25...6	
Ferrule with plastic collar	mm <sup>2</sup>	0.25...6	
Stripping length	mm	12	
Screwdriver blade	mm		
According to norm			
Tightening torque range			
<b>Rated current, max.</b>	<b>A</b>	<b>41</b>	<b>41</b>
At ambient temperature		20°C	40°C
For conductor cross-section			
Overtoltage category		III	III II
Pollution severity		3	2 2
<b>Rated voltage</b>	<b>V</b>	<b>1000</b>	<b>1000 1000</b>
Rated impulse voltage	kV	8	8 8
<b>UL / CUL (Use Group)</b>	<b>B C D</b>	<b>B</b>	<b>C D</b>
<b>Rated voltage</b>	<b>V</b>	<b>600</b>	<b>600 600</b>
<b>Rated current</b>	<b>A</b>	<b>35</b>	<b>35 5</b>
<b>AWG conductor</b>	<b>AWG</b>	<b>24-8</b>	
<b>CSA (Use Group)</b>	<b>B C D</b>	<b>B</b>	<b>C D</b>
Rated voltage	V	600	600 600
Rated current	A	35	35 5
AWG conductor	AWG	24-8	
<b>General data</b>			
Type of insulation material		Wemid (PA)	
UL 94 flammability rating		V-0	
Contact base material		E-Cu	
Material of contact surface		tinned	
Pin dimensions = d	mm	d = 1.5	
Solder eyelet Ø = D	mm	2	
Solder eyelet Ø tolerance	mm	+ 0,1	

Product data

IEC: 1000 V / 41 A / 0.5 - 6 mm<sup>2</sup>  
 UL: 600 V / 35 A / AWG 24 - 8



For additional articles and information, refer to [catalog.weidmueller.com](http://catalog.weidmueller.com)

Note:

- Additional colours on request
- Rated current related to rated cross-section & min. No. of poles.
- Wire end ferrule without plastic collar to DIN 46228/1
- Wire end ferrule with plastic collar to DIN 46228/4
- P on drawing = pitch
- Rated data refer only to the component itself. Clearance and creepage distances to other components are to be designed in accordance with the relevant application standards.
- The test point can only be used as potential-pickup point.

LLF 7.50/.. /90V



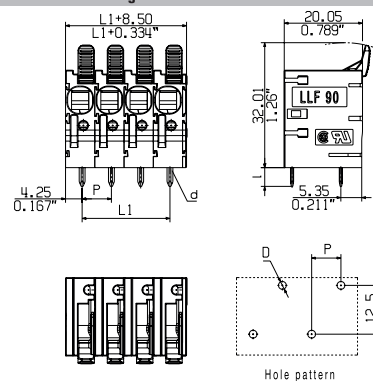

Dimensioned drawing



Accessories

Note: Refer to the Accessories chapter for additional accessories.

Screwdriver		Order No.
	SDIS 0.5X3.0X100	<b>9008380000</b>
	SDS 0.5X3.0X80	<b>9008320000</b>
Test plug		
	PS 2.0 MC	<b>0310000000</b>

Ordering data

Solder pin length		5 mm		
Colour		Black		
Pitch		7.50 mm		
Pol.	L1	(inch)	Qty.	Order No.
2	7.50	0.295	100	<b>2471530000</b>
3	15.00	0.590	80	<b>2472090000</b>
4	22.50	0.885	80	<b>2472100000</b>
5	30.00	1.180	50	<b>2472110000</b>
6	37.50	1.475	50	<b>2472120000</b>
7	45.00	1.770	50	<b>2472130000</b>
8	52.50	2.065	30	<b>2472140000</b>
9	60.00	2.360	30	<b>2472150000</b>
10	67.50	2.655	20	<b>2472160000</b>
11	75.00	2.950	20	<b>2472170000</b>
12	82.50	3.245	20	<b>2472180000</b>

Representative deratings curve

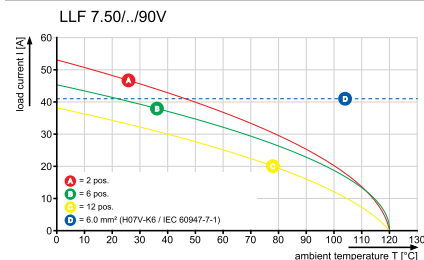

LLFS 7.50/./90

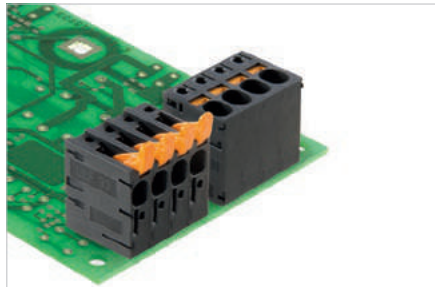

High-performance PCB terminal with PUSH IN connection system for wire cross-sections up to 6 mm<sup>2</sup>.

- Fast connection without tools thanks to an operating lever for opening the contact point, or direct insertion
- Securely closed contact point: with the "Connection Safety Concept" the conductor is always clamped securely
- Integrated test point for test plug PS 2.0
- Central tip test point for test probes on the upper side of the terminal
- Increased derating reserves through the use of WEMID insulating material
- Wire outlet direction: 90° version

Technical data

In compliance with IEC 60664-1 / IEC 61984			
Clamping range, max.	mm <sup>2</sup>	0.25...6	
<b>Solid core H05(07) V-U</b>	<b>mm<sup>2</sup></b>	<b>0.5...4</b>	
Stranded H07 V-R			
Flexible H05(07) V-K	mm <sup>2</sup>	0.5...6	
Flexible with ferrule	mm <sup>2</sup>	0.25...6	
Ferrule with plastic collar	mm <sup>2</sup>	0.25...6	
Stripping length	mm	12	
Screwdriver blade	mm		
According to norm			
Tightening torque range			
<b>Rated current, max.</b>	<b>A</b>	<b>41</b>	<b>41</b>
At ambient temperature		20°C	40°C
For conductor cross-section			
Overtoltage category		III	III II
Pollution severity		3	2 2
<b>Rated voltage</b>	<b>V</b>	<b>600</b>	<b>600 1000</b>
Rated impulse voltage	kV	6	6 6
<b>UL / CUL (Use Group)</b>		<b>B</b>	<b>C D</b>
<b>Rated voltage</b>	<b>V</b>	<b>300</b>	<b>150 300</b>
<b>Rated current</b>	<b>A</b>	<b>37</b>	<b>37 10</b>
<b>AWG conductor</b>	<b>AWG</b>		<b>24-8</b>
<b>CSA (Use Group)</b>		<b>B</b>	<b>C D</b>
Rated voltage	V	300	1000 300
Rated current	A	37	37 10
AWG conductor	AWG		-
<b>General data</b>			
Type of insulation material		Wemid (PA)	
UL 94 flammability rating		V-0	
Contact base material		E-Cu	
Material of contact surface		tinned	
Pin dimensions = d	mm	d = 1.5	
Solder eyelet Ø = D	mm	2	
Solder eyelet Ø tolerance	mm	+ 0,1	

Product data

IEC: 1000 V / 41 A / 0.5 - 6 mm<sup>2</sup>  
 UL: 300 V / 37 A / AWG 24 - 8



For additional articles and information, refer to [catalog.weidmueller.com](http://catalog.weidmueller.com)

Note:

- Additional colours on request
- Rated current related to rated cross-section & min. No. of poles.
- Wire end ferrule without plastic collar to DIN 46228/1
- Wire end ferrule with plastic collar to DIN 46228/4
- P on drawing = pitch
- Rated data refer only to the component itself. Clearance and creepage distances to other components are to be designed in accordance with the relevant application standards.
- The test point can only be used as potential-pickup point.

LLFS 7.50/./90



Dimensioned drawing

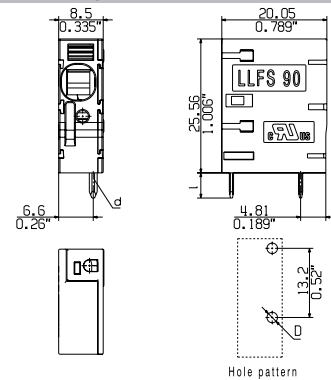

Ordering data

Solder pin length	5 mm		
Colour	Black		
<b>Pitch</b>	<b>7.50 mm</b>		
Pol.	L1	(inch)	Qty. Order No.
1	0.00	0.000	200 2473420000

Accessories

Note: Refer to the Accessories chapter for additional accessories.

Screwdriver		Order No.
	SDIS 0.8X4.0X100	9008400000
	SDS 0.8X4.0X100	9008340000
Test plug		
	PS 2.0 MC	0310000000

Representative deratings curve

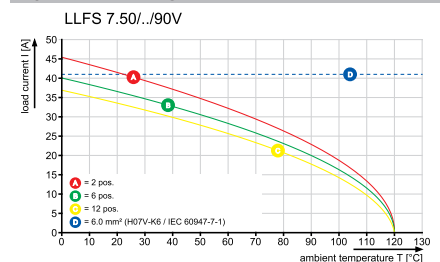

LLFS 7.50/./90V

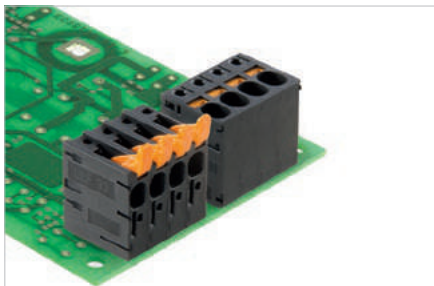

High-performance PCB terminal with PUSH IN connection system for wire cross-sections up to 6 mm<sup>2</sup>.

- Fast connection without tools thanks to an operating lever for opening the contact point, or direct insertion
- Securely closed contact point: with the "Connection Safety Concept" the conductor is always clamped securely
- Integrated test point for test plug PS 2.0
- Central tip test point for test probes on the upper side of the terminal
- Increased derating reserves through the use of WEMID insulating material
- Wire outlet direction: 90° version

Technical data

In compliance with IEC 60664-1 / IEC 61984			
Clamping range, max.	mm <sup>2</sup>	0.25...6	
<b>Solid core H05(07) V-U</b>	<b>mm<sup>2</sup></b>	<b>0.5...6</b>	
Stranded H07 V-R			
Flexible H05(07) V-K	mm <sup>2</sup>	0.5...6	
Flexible with ferrule	mm <sup>2</sup>	0.25...6	
Ferrule with plastic collar	mm <sup>2</sup>	0.25...6	
Stripping length	mm	12	
Screwdriver blade	mm		
According to norm			
Tightening torque range			
<b>Rated current, max.</b>	<b>A</b>	<b>41</b>	<b>37</b>
At ambient temperature	20°C	40°C	
For conductor cross-section			
Overtoltage category		III	III II
Pollution severity		3	2 2
<b>Rated voltage</b>	<b>V</b>	<b>1000</b>	<b>1000 1000</b>
Rated impulse voltage	kV	8	8 8
<b>UL / CUL (Use Group)</b>		<b>B</b>	<b>C D</b>
<b>Rated voltage</b>	<b>V</b>	<b>600</b>	<b>600 600</b>
<b>Rated current</b>	<b>A</b>	<b>37</b>	<b>37 5</b>
<b>AWG conductor</b>	<b>AWG</b>		<b>24-8</b>
<b>CSA (Use Group)</b>		<b>B</b>	<b>C D</b>
Rated voltage	V	600	600 600
Rated current	A	37	37 5
AWG conductor	AWG		24-8
<b>General data</b>			
Type of insulation material		Wemid (PA)	
UL 94 flammability rating		V-0	
Contact base material		E-Cu	
Material of contact surface		tinned	
Pin dimensions = d	mm	d = 1.5	
Solder eyelet Ø = D	mm	2	
Solder eyelet Ø tolerance	mm	+ 0,1	

Product data

IEC: 1000 V / 41 A / 0.5 - 6 mm<sup>2</sup>  
 UL: 600 V / 37 A / AWG 24 - 8



For additional articles and information, refer to [catalog.weidmueller.com](http://catalog.weidmueller.com)

Note:

- Additional colours on request
- Rated current related to rated cross-section & min. No. of poles.
- Wire end ferrule without plastic collar to DIN 46228/1
- Wire end ferrule with plastic collar to DIN 46228/4
- P on drawing = pitch
- Rated data refer only to the component itself. Clearance and creepage distances to other components are to be designed in accordance with the relevant application standards.
- The test point can only be used as potential-pickup point.

LLFS 7.50/./90V



Dimensioned drawing

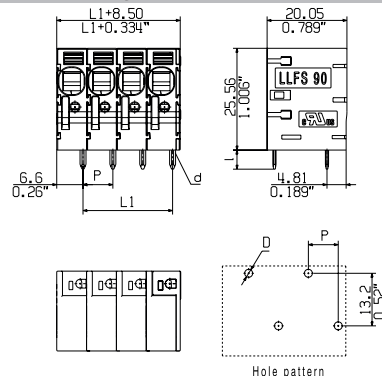

Accessories

Note: Refer to the Accessories chapter for additional accessories.

Screwdriver		Order No.
	SDIS 0.8X4.0X100	9008400000
	SDS 0.8X4.0X100	9008340000
Test plug		
	PS 2.0 MC	0310000000

Ordering data

Solder pin length		5 mm		
Colour		Black		
Pitch		7.50 mm		
Pol.	L1	(inch)	Qty.	Order No.
2	7.50	0.295	100	2473000000
3	15.00	0.590	80	2473010000
4	22.50	0.885	80	2473020000
5	30.00	1.180	50	2473030000
6	37.50	1.475	50	2473040000
7	45.00	1.770	50	2473050000
8	52.50	2.065	30	2473060000
9	60.00	2.360	30	2473070000
10	67.50	2.655	20	2473080000
11	75.00	2.950	20	2473090000
12	82.50	3.245	20	2473100000

Representative deratings curve

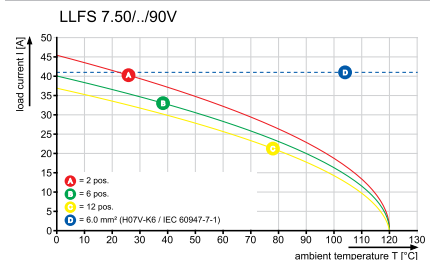

LLFS 7.50/./180

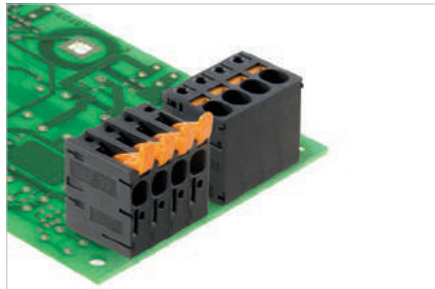

High-performance PCB terminal with PUSH IN connection system for wire cross-sections up to 6 mm<sup>2</sup>.

- Fast connection without tools thanks to an operating lever for opening the contact point, or direct insertion
- Securely closed contact point: with the "Connection Safety Concept" the conductor is always clamped securely
- Integrated test point for test plug PS 2.0
- Central tip test point for test probes on the upper side of the terminal
- Increased derating reserves through the use of WEMID insulating material
- Wire outlet direction: 90° version

Technical data

In compliance with IEC 60664-1 / IEC 61984			
Clamping range, max.	mm <sup>2</sup>	0.25...6	
<b>Solid core H05(07) V-U</b>	<b>mm<sup>2</sup></b>	<b>0.5...6</b>	
Stranded H07 V-R			
Flexible H05(07) V-K	mm <sup>2</sup>	0.5...6	
Flexible with ferrule	mm <sup>2</sup>	0.25...6	
Ferrule with plastic collar	mm <sup>2</sup>	0.25...6	
Stripping length	mm	12	
Screwdriver blade	mm		
According to norm			
Tightening torque range			
<b>Rated current, max.</b>	<b>A</b>	<b>41</b>	<b>41</b>
At ambient temperature		20°C	40°C
For conductor cross-section			
Overtoltage category		III	III II
Pollution severity		3	2 2
<b>Rated voltage</b>	<b>V</b>	<b>600</b>	<b>600 1000</b>
Rated impulse voltage	kV	6	6 6
<b>UL / CUL (Use Group)</b>		<b>B</b>	<b>C D</b>
<b>Rated voltage</b>	<b>V</b>	<b>300</b>	<b>150 300</b>
<b>Rated current</b>	<b>A</b>	<b>37</b>	<b>37 10</b>
<b>AWG conductor</b>	<b>AWG</b>		<b>24-8</b>
<b>CSA (Use Group)</b>		<b>B</b>	<b>C D</b>
Rated voltage	V	300	1000 300
Rated current	A	37	37 10
AWG conductor	AWG		24-8
<b>General data</b>			
Type of insulation material		Wemid (PA)	
UL 94 flammability rating		V-0	
Contact base material		E-Cu	
Material of contact surface		tinned	
Pin dimensions = d	mm	d = 1.5	
Solder eyelet Ø = D	mm	2	
Solder eyelet Ø tolerance	mm	+ 0,1	

Product data

IEC: 1000 V / 41 A / 0.5 - 6 mm<sup>2</sup>  
 UL: 300 V / 37 A / AWG 24 - 8



For additional articles and information, refer to [catalog.weidmueller.com](http://catalog.weidmueller.com)

Note:

- Additional colours on request
- Rated current related to rated cross-section & min. No. of poles.
- Wire end ferrule without plastic collar to DIN 46228/1
- Wire end ferrule with plastic collar to DIN 46228/4
- P on drawing = pitch
- Rated data refer only to the component itself. Clearance and creepage distances to other components are to be designed in accordance with the relevant application standards.
- The test point can only be used as potential-pickup point.

LLFS 7.50/./180



Dimensioned drawing

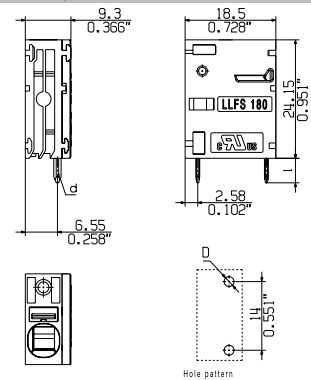

Ordering data

Solder pin length	5 mm			
Colour	Black			
Pitch	7.50 mm			
Pol.	L1	(inch)	Qty.	Order No.
1	0.00	0.000	200	2491110000

Accessories

Note: Refer to the Accessories chapter for additional accessories.

Screwdriver		Order No.
	SDIS 0.8X4.0X100	9008400000
	SDS 0.8X4.0X100	9008340000
Test plug		
	PS 2.0 MC	0310000000

Representative deratings curve

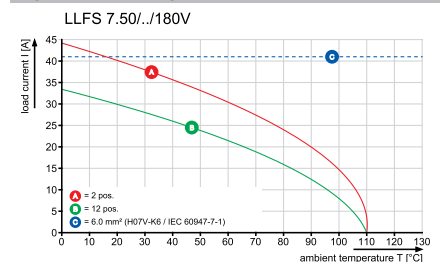

LLFS 7.50../180V

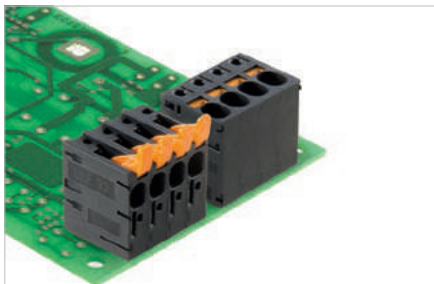

High-performance PCB terminal with PUSH IN connection system for wire cross-sections up to 6 mm<sup>2</sup>.

- Fast connection without tools thanks to an operating lever for opening the contact point, or direct insertion
- Securely closed contact point: with the "Connection Safety Concept" the conductor is always clamped securely
- Integrated test point for test plug PS 2.0
- Central tip test point for test probes on the upper side of the terminal
- Increased derating reserves through the use of WEMID insulating material
- Wire outlet direction: 90° version

Technical data

In compliance with IEC 60664-1 / IEC 61984			
Clamping range, max.	mm <sup>2</sup>	0.25...6	
<b>Solid core H05(07) V-U</b>	<b>mm<sup>2</sup></b>	<b>0.5...6</b>	
Stranded H07 V-R			
Flexible H05(07) V-K	mm <sup>2</sup>	0.5...6	
Flexible with ferrule	mm <sup>2</sup>	0.25...6	
Ferrule with plastic collar	mm <sup>2</sup>	0.25...6	
Stripping length	mm	12	
Screwdriver blade	mm		
According to norm			
Tightening torque range			
<b>Rated current, max.</b>	<b>A</b>	<b>41</b>	<b>38</b>
At ambient temperature		20°C	40°C
For conductor cross-section			
Overtoltage category		III	III II
Pollution severity		3	2 2
<b>Rated voltage</b>	<b>V</b>	<b>1000</b>	<b>1000 1000</b>
Rated impulse voltage	kV	8	8 8
<b>UL / CUL (Use Group)</b>		<b>B</b>	<b>C D</b>
<b>Rated voltage</b>	<b>V</b>	<b>600</b>	<b>600 600</b>
<b>Rated current</b>	<b>A</b>	<b>37</b>	<b>37 5</b>
<b>AWG conductor</b>	<b>AWG</b>		<b>24-8</b>
<b>CSA (Use Group)</b>		<b>B</b>	<b>C D</b>
Rated voltage	V	600	600 600
Rated current	A	37	37 5
AWG conductor	AWG		-
General data			
Type of insulation material		Wemid (PA)	
UL 94 flammability rating		V-0	
Contact base material		E-Cu	
Material of contact surface		tinned	
Pin dimensions = d	mm	d = 1.5	
Solder eyelet Ø = D	mm	2	
Solder eyelet Ø tolerance	mm	+ 0,1	

Product data

IEC: 1000 V / 41 A / 0.5 - 6 mm<sup>2</sup>  
 UL: 600 V / 37 A / AWG 24 - 8



For additional articles and information, refer to [catalog.weidmueller.com](http://catalog.weidmueller.com)

Note:

- Additional colours on request
- Rated current related to rated cross-section & min. No. of poles.
- Wire end ferrule without plastic collar to DIN 46228/1
- Wire end ferrule with plastic collar to DIN 46228/4
- P on drawing = pitch
- Rated data refer only to the component itself. Clearance and creepage distances to other components are to be designed in accordance with the relevant application standards.
- The test point can only be used as potential-pickup point.

LLFS 7.50../180V



Dimensioned drawing

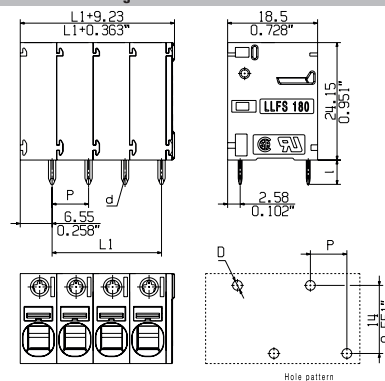

Accessories

Note: Refer to the Accessories chapter for additional accessories.

Screwdriver		Order No.
	SDIS 0.8X4.0X100	9008400000
	SDS 0.8X4.0X100	9008340000
Test plug		
	PS 2.0 MC	0310000000

Ordering data

Solder pin length		5 mm		
Colour		Black		
Pitch		7.50 mm		
Pol.	L1	(inch)	Qty.	Order No.
2	0.00	0.000	100	2491620000
3	7.50	0.295	80	2491630000
4	15.00	0.590	80	2491640000
5	22.50	0.885	50	2491650000
6	30.00	1.180	50	2491660000
7	37.50	1.475	50	2491670000
8	45.00	1.770	30	2491680000
9	52.50	2.065	30	2491690000
10	60.00	2.360	20	2491700000
11	67.50	2.655	20	2491710000
12	75.00	2.950	20	2491720000

Representative deratings curve

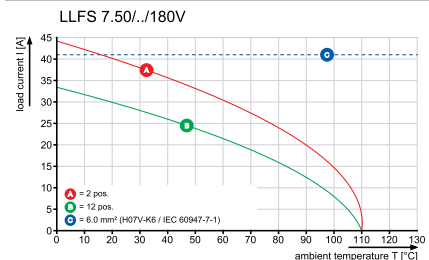

LUF 10.00/./90

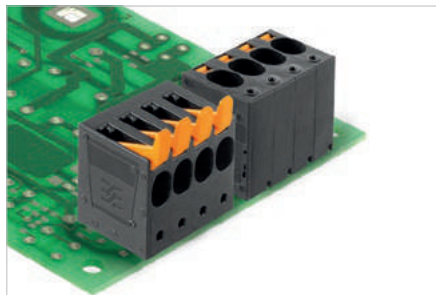

High-performance PCB terminal block with PUSH IN connection system for wire cross-sections up to 16 mm<sup>2</sup>.

- Fast connection without tools thanks to an operating lever for opening the contact point, or direct insertion
- Securely closed contact point: with the Connection Safety Concept, the conductor is always clamped securely
- Integrated test point for PS 2.0 test plug
- Central tip test point for test probes on the upper side of the terminal
- Increased derating reserves thanks to WEMID insulating material
- Wire outlet direction of 90°

Technical data

<b>In compliance with IEC 60664-1 / IEC 61984</b>			
Clamping range, max.	mm <sup>2</sup>	0.5...16	
<b>Solid core H05(07) V-U</b>	<b>mm<sup>2</sup></b>	<b>0.5...16</b>	
Stranded H07 V-R	mm <sup>2</sup>	6...16	
Flexible H05(07) V-K	mm <sup>2</sup>	0.5...16	
Flexible with ferrule	mm <sup>2</sup>	0.5...16	
Ferrule with plastic collar	mm <sup>2</sup>	0.5...16	
Stripping length	mm	18	
Screwdriver blade	mm	0.8 x 4.0	
According to norm			
Tightening torque range			
<b>Rated current, max.</b>	<b>A</b>	<b>76</b>	<b>76</b>
At ambient temperature		20°C	40°C
For conductor cross-section		III	III II
Overtoltage category		III	III II
Pollution severity		3	2 2
<b>Rated voltage</b>	<b>V</b>	<b>1000</b>	<b>1000 1000</b>
Rated impulse voltage	kV	8	8 6
<b>UL / CUL (Use Group)</b>		<b>B</b>	<b>C D</b>
<b>Rated voltage</b>	<b>V</b>	<b>300</b>	<b>600 600</b>
<b>Rated current</b>	<b>A</b>	<b>61</b>	<b>61 5</b>
<b>AWG conductor</b>	<b>AWG</b>		<b>18-6</b>
<b>CSA (Use Group)</b>		<b>B</b>	<b>C D</b>
Rated voltage	V	300	1000 600
Rated current	A	61	61 5
AWG conductor	AWG		18-6
<b>General data</b>			
Type of insulation material		Wemid (PA)	
UL 94 flammability rating		V-0	
Contact base material			
Material of contact surface			
Pin dimensions = d	mm	1.2, Octagonal	
Solder eyelet Ø = D	mm	1.6	
Solder eyelet Ø tolerance	mm	+ 0,1	

Product data

IEC: 1000 V / 76 A / 0.5 - 16 mm<sup>2</sup>  
 UL: 300 V / 61 A / AWG 18 - 6



For additional articles and information, refer to [catalog.weidmuller.com](http://catalog.weidmuller.com)

Note:

- Additional colours on request
- Rated current related to rated cross-section & min. No. of poles.
- Wire end ferrule without plastic collar to DIN 46228/1
- Wire end ferrule with plastic collar to DIN 46228/4
- P on drawing = pitch
- Rated data refer only to the component itself. Clearance and creepage distances to other components are to be designed in accordance with the relevant application standards.
- The test point can only be used as potential-pickup point.

LUF 10.00/./90



Dimensioned drawing

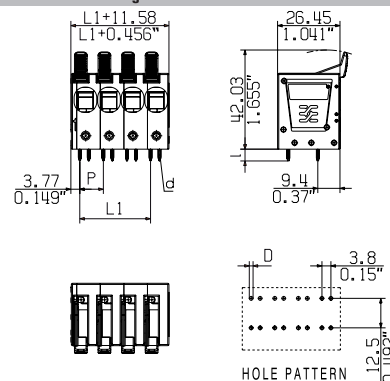

Accessories

Note: Refer to the Accessories chapter for additional accessories.

<b>Screwdriver</b>		<b>Order No.</b>
	SDS 0.8X4.0X100	<b>9008340000</b>
	SDIS 0.8X4.0X100	<b>9008400000</b>
<b>Test plug</b>		
	PS 2.0 MC	<b>0310000000</b>

Ordering data

<b>Solder pin length</b>		<b>5 mm</b>		
<b>Colour</b>		<b>Black</b>		
<b>Pitch</b>		<b>10.00 mm</b>		
Pol.	L1	(inch)	Qty.	Order No.
1	0.00	0.000	50	<b>1988590000</b>
2	10.00	0.394	40	<b>1988600000</b>
3	20.00	0.787	40	<b>1988610000</b>
4	30.00	1.181	30	<b>1988620000</b>
5	40.00	1.575	25	<b>1988630000</b>
6	50.00	1.969	20	<b>1988640000</b>
7	60.00	2.362	10	<b>1988650000</b>
8	70.00	2.756	10	<b>1988660000</b>
9	80.00	3.150	10	<b>1988670000</b>
10	90.00	3.543	10	<b>1988680000</b>
11	100.00	3.937	10	<b>1988690000</b>
12	110.00	4.331	10	<b>1988700000</b>

Representative deratings curve

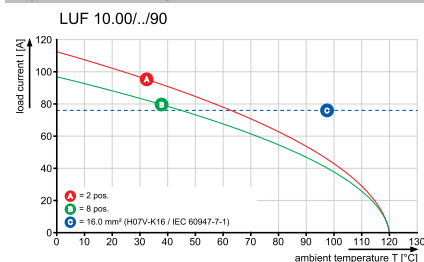

LUF 10.00/./90V

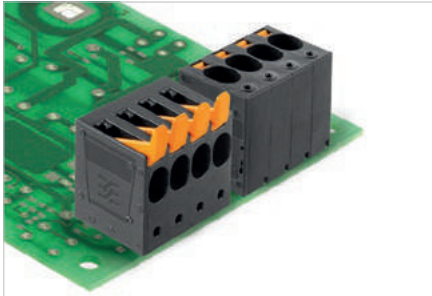

High-performance PCB terminal with PUSH IN connection system for wire cross-sections up to 16 mm<sup>2</sup>.

- Fast connection without tools thanks to an operating lever for opening the contact point, or direct insertion
- Securely closed contact point: with the "Connection Safety Concept" the conductor is always clamped securely
- Integrated test point for test plug PS 2.0
- Central tip test point for test probes on the upper side of the terminal
- Increased derating reserves through the use of WEMID insulating material
- Wire outlet direction: 90° version

Technical data

In compliance with IEC 60664-1 / IEC 61984			
Clamping range, max.	mm <sup>2</sup>	0.5...16	
<b>Solid core H05(07) V-U</b>	<b>mm<sup>2</sup></b>	<b>0.5...16</b>	
Stranded H07 V-R	mm <sup>2</sup>	6...16	
Flexible H05(07) V-K	mm <sup>2</sup>	0.5...16	
Flexible with ferrule	mm <sup>2</sup>	0.5...16	
Ferrule with plastic collar	mm <sup>2</sup>	0.5...16	
Stripping length	mm	18	
Screwdriver blade	mm	0.8 x 4.0	
According to norm			
Tightening torque range			
<b>Rated current, max.</b>	<b>A</b>	<b>76</b>	<b>76</b>
At ambient temperature		20°C	40°C
For conductor cross-section			
Overtoltage category		III	III II
Pollution severity		3	2 2
<b>Rated voltage</b>	<b>V</b>	<b>1000</b>	<b>1000 1000</b>
Rated impulse voltage	kV	8	8 8
<b>UL / CUL (Use Group)</b>		<b>B</b>	<b>C D</b>
<b>Rated voltage</b>	<b>V</b>	<b>600</b>	<b>600 600</b>
<b>Rated current</b>	<b>A</b>	<b>58</b>	<b>58 5</b>
<b>AWG conductor</b>	<b>AWG</b>	<b>18-6</b>	
<b>CSA (Use Group)</b>		<b>B</b>	<b>C D</b>
Rated voltage	V	600	600 600
Rated current	A	58	58 5
AWG conductor	AWG	18-6	
General data			
Type of insulation material		Wemid (PA)	
UL 94 flammability rating		V-0	
Contact base material			
Material of contact surface			
Pin dimensions = d	mm	1.2, Octagonal	
Solder eyelet Ø = D	mm	1.6	
Solder eyelet Ø tolerance	mm	+ 0,1	

Product data

IEC: 1000 V / 76 A / 0.5 - 16 mm<sup>2</sup>  
 UL: 600 V / 58 A / AWG 18 - 6



For additional articles and information, refer to [catalog.weidmueller.com](http://catalog.weidmueller.com)

Note:

- Additional colours on request
- Rated current related to rated cross-section & min. No. of poles.
- Wire end ferrule without plastic collar to DIN 46228/1
- Wire end ferrule with plastic collar to DIN 46228/4
- P on drawing = pitch
- Rated data refer only to the component itself. Clearance and creepage distances to other components are to be designed in accordance with the relevant application standards.
- The test point can only be used as potential-pickup point.

LUF 10.00/./90V



Dimensioned drawing

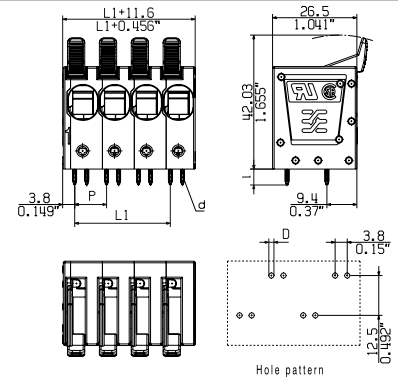

Accessories

Note: Refer to the Accessories chapter for additional accessories.

Screwdriver		Order No.
	SDIS 0.8X4.0X100	9008400000
	SDS 0.8X4.0X100	9008340000
Test plug		
	PS 2.0 MC	0310000000

Ordering data

Solder pin length		5 mm		
Colour		Black		
Pitch 10.00 mm				
Pol.	L1	(inch)	Qty.	Order No.
2	10.00	0.394	40	2453690000
3	20.00	0.787	40	2453700000
4	30.00	1.181	30	2453710000
5	40.00	1.575	30	2453720000
6	50.00	1.969	20	2453730000
7	60.00	2.362	10	2453740000
8	70.00	2.756	10	2453750000
9	80.00	3.150	10	2453760000
10	90.00	3.543	10	2453770000
11	100.00	3.937	10	2453780000
12	110.00	4.331	1	2453790000

Representative deratings curve

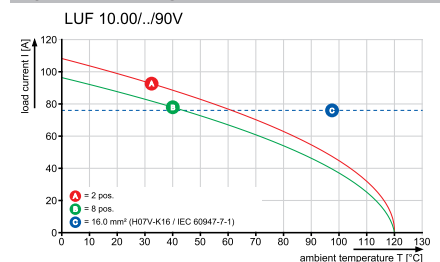

LUFS 10.00/./90

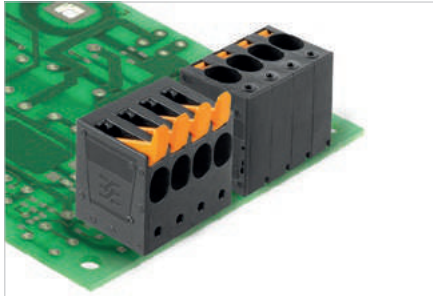

High-performance PCB terminal block with PUSH IN connection system for wire cross-sections up to 16 mm<sup>2</sup>.

- Fast connection without tools thanks to an operating lever for opening the contact point, or direct insertion
- Securely closed contact point: with the Connection Safety Concept, the conductor is always clamped securely
- Integrated test point for PS 2.0 test plug
- Central tip test point for test probes on the upper side of the terminal
- Increased derating reserves thanks to WEMID insulating material
- Wire outlet direction of 90°

Technical data

In compliance with IEC 60664-1 / IEC 61984			
Clamping range, max.	mm <sup>2</sup>	0.5...16	
<b>Solid core H05(07) V-U</b>	<b>mm<sup>2</sup></b>	<b>0.5...16</b>	
Stranded H07 V-R	mm <sup>2</sup>	6...16	
Flexible H05(07) V-K	mm <sup>2</sup>	0.5...16	
Flexible with ferrule	mm <sup>2</sup>	0.5...16	
Ferrule with plastic collar	mm <sup>2</sup>	0.5...16	
Stripping length	mm	18	
Screwdriver blade	mm	0.8 x 4.0	
According to norm			
Tightening torque range			
<b>Rated current, max.</b>	<b>A</b>	<b>76</b>	<b>76</b>
At ambient temperature		20°C	40°C
For conductor cross-section			
Overtoltage category		III	III II
Pollution severity		3	2 2
<b>Rated voltage</b>	<b>V</b>	<b>630</b>	<b>690 1000</b>
Rated impulse voltage	kV	6	6 6
<b>UL / CUL (Use Group)</b>		<b>B</b>	<b>C D</b>
<b>Rated voltage</b>	<b>V</b>	<b>600</b>	<b>600 600</b>
<b>Rated current</b>	<b>A</b>	<b>53</b>	<b>53 5</b>
<b>AWG conductor</b>	<b>AWG</b>	<b>18-4</b>	
<b>CSA (Use Group)</b>		<b>B</b>	<b>C D</b>
Rated voltage	V	600	600 600
Rated current	A	53	53 5
AWG conductor	AWG	18-4	
<b>General data</b>			
Type of insulation material		Wemid (PA)	
UL 94 flammability rating		V-0	
Contact base material			
Material of contact surface			
Pin dimensions = d	mm	1.2, Octagonal	
Solder eyelet Ø = D	mm	1.6	
Solder eyelet Ø tolerance	mm	+ 0,1	

Product data

IEC: 1000 V / 76 A / 0.5 - 16 mm<sup>2</sup>  
 UL: 600 V / 53 A / AWG 18-4



For additional articles and information, refer to [catalog.weidmueller.com](http://catalog.weidmueller.com)

Note:

- Additional colours on request
- Rated current related to rated cross-section & min. No. of poles.
- Wire end ferrule without plastic collar to DIN 46228/1
- Wire end ferrule with plastic collar to DIN 46228/4
- P on drawing = pitch
- Rated data refer only to the component itself. Clearance and creepage distances to other components are to be designed in accordance with the relevant application standards.
- The test point can only be used as potential-pickup point.

LUFS 10.00/./90



Dimensioned drawing

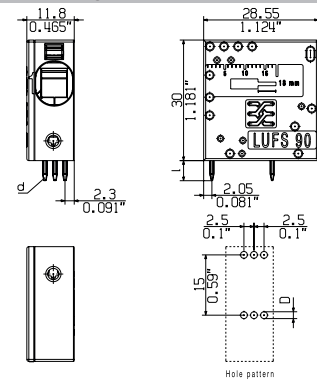

Ordering data

Solder pin length	5 mm		
Colour	Black		
<b>Pitch</b>	<b>10.00 mm</b>		
Pol.	L1	(inch)	Qty. Order No.
1	0.00	0.000	50 2500560000

Accessories

Note: Refer to the Accessories chapter for additional accessories.

Screwdriver		Order No.
	SDIS 0.8X4.0X100	9008400000
	SDS 0.8X4.0X100	9008340000
Test plug		
	PS 2.0 MC	0310000000

Representative deratings curve

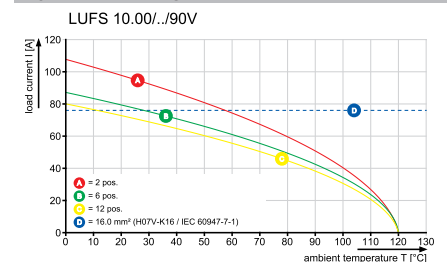



LUF5 10.00/./90V

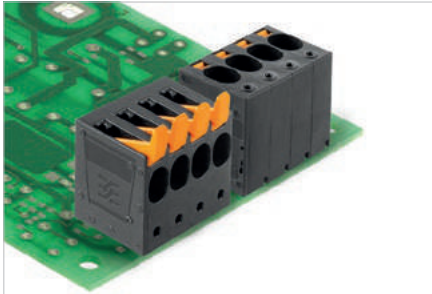

High-performance PCB terminal block with PUSH IN connection system for wire cross-sections up to 16 mm<sup>2</sup>.

- Fast connection without tools thanks to an operating lever for opening the contact point, or direct insertion
- Securely closed contact point: with the Connection Safety Concept, the conductor is always clamped securely
- Integrated test point for PS 2.0 test plug
- Central tip test point for test probes on the upper side of the terminal
- Increased derating reserves thanks to WEMID insulating material
- Wire outlet direction of 90°

Technical data

In compliance with IEC 60664-1 / IEC 61984			
Clamping range, max.	mm <sup>2</sup>	0.5...16	
<b>Solid core H05(07) V-U</b>	<b>mm<sup>2</sup></b>	<b>0.5...16</b>	
Stranded H07 V-R	mm <sup>2</sup>	6...16	
Flexible H05(07) V-K	mm <sup>2</sup>	0.5...16	
Flexible with ferrule	mm <sup>2</sup>	0.5...16	
Ferrule with plastic collar	mm <sup>2</sup>	0.5...16	
Stripping length	mm	18	
Screwdriver blade	mm	0.8 x 4.0	
According to norm			
Tightening torque range			
<b>Rated current, max.</b>	<b>A</b>	<b>76</b>	<b>76</b>
At ambient temperature		20°C	40°C
For conductor cross-section		III	III II
Overtoltage category		III	III II
Pollution severity		3	2 2
<b>Rated voltage</b>	<b>V</b>	<b>1000</b>	<b>1000 1000</b>
Rated impulse voltage	kV	8	8 8
<b>UL / CUL (Use Group)</b>		<b>B</b>	<b>C D</b>
<b>Rated voltage</b>	<b>V</b>	<b>600</b>	<b>600 600</b>
<b>Rated current</b>	<b>A</b>	<b>53</b>	<b>53 5</b>
<b>AWG conductor</b>	<b>AWG</b>	<b>18-4</b>	
<b>CSA (Use Group)</b>		<b>B</b>	<b>C D</b>
Rated voltage	V	600	600 600
Rated current	A	53	53 5
AWG conductor	AWG	18-4	
<b>General data</b>			
Type of insulation material		Wemid (PA)	
UL 94 flammability rating		V-0	
Contact base material			
Material of contact surface			
Pin dimensions = d	mm	1.2, Octagonal	
Solder eyelet Ø = D	mm	1.6	
Solder eyelet Ø tolerance	mm	+ 0,1	

Product data

IEC: 1000 V / 76 A / 0.5 - 16 mm<sup>2</sup>  
 UL: 600 V / 53 A / AWG 18 - 4



For additional articles and information, refer to [catalog.weidmuller.com](http://catalog.weidmuller.com)

Note:

- Additional colours on request
- Rated current related to rated cross-section & min. No. of poles.
- Wire end ferrule without plastic collar to DIN 46228/1
- Wire end ferrule with plastic collar to DIN 46228/4
- P on drawing = pitch
- Rated data refer only to the component itself. Clearance and creepage distances to other components are to be designed in accordance with the relevant application standards.
- The test point can only be used as potential-pickup point.

LUF5 10/./90V



Dimensioned drawing

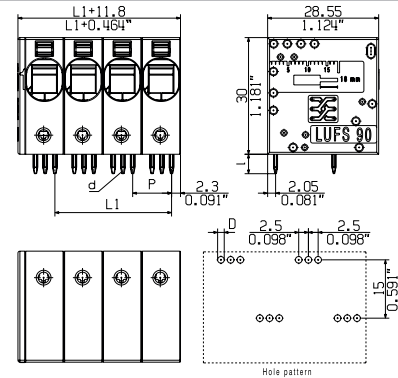

Accessories

Note: Refer to the Accessories chapter for additional accessories.

Screwdriver		Order No.
	SDIS 0.8X4.0X100	9008400000
	SDS 0.8X4.0X100	9008340000
Test plug		
	PS 2.0 MC	0310000000

Ordering data

Solder pin length		5 mm		
Colour		Black		
Pitch		10.00 mm		
Pol.	L1	(inch)	Qty.	Order No.
2	10.00	0.394	40	2499430000
3	20.00	0.787	40	2500460000
4	30.00	1.181	30	2500470000
5	40.00	1.575	25	2500480000
6	50.00	1.969	20	2500490000
7	60.00	2.362	10	2500500000
8	70.00	2.756	10	2500510000
9	80.00	3.150	10	2500520000
10	90.00	3.543	10	2500530000
11	100.00	3.937	10	2500540000
12	110.00	4.331	10	2500550000

Representative deratings curve

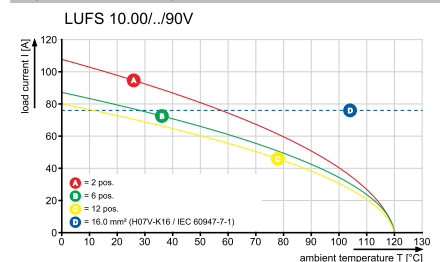

LUF5 10.00/./180

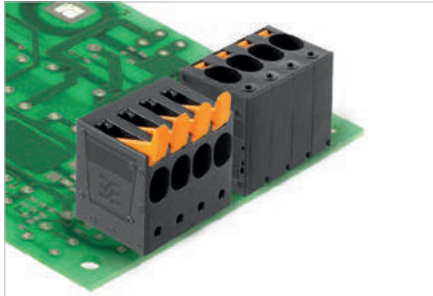

High-performance PCB terminal with PUSH IN connection system for wire cross-sections up to 16 mm<sup>2</sup>.

- Fast connection thanks to a pusher for opening the contact point, or direct insertion
- Securely closed contact point: with the "Connection Safety Concept" the conductor is always clamped securely
- Integrated test point for test plug PS 2.0
- Increased derating reserves through the use of WEMID insulating material
- Wire outlet direction and activation in 180° version

Technical data

In compliance with IEC 60664-1 / IEC 61984

Clamping range, max.	mm <sup>2</sup>	0.5...16
<b>Solid core H05(07) V-U</b>	<b>mm<sup>2</sup></b>	<b>0.5...16</b>
Stranded H07 V-R	mm <sup>2</sup>	6...16
Flexible H05(07) V-K	mm <sup>2</sup>	0.5...16
Flexible with ferrule	mm <sup>2</sup>	0.5...16
Ferrule with plastic collar	mm <sup>2</sup>	0.5...16
Stripping length	mm	18
Screwdriver blade	mm	0.8 x 4.0

According to norm

Tightening torque range			
<b>Rated current, max.</b>	<b>A</b>	<b>76</b>	<b>76</b>
At ambient temperature		20°C	40°C

For conductor cross-section			
Overtoltage category		III	III
Pollution severity		3	2
		2	2

<b>Rated voltage</b>	<b>V</b>	<b>1000</b>	<b>1000</b>	<b>1000</b>
Rated impulse voltage	kV	8	8	6

UL / CUL (Use Group)

<b>Rated voltage</b>	<b>V</b>	<b>600</b>	<b>600</b>	<b>600</b>
<b>Rated current</b>	<b>A</b>	<b>57</b>	<b>57</b>	<b>5</b>
<b>AWG conductor</b>	<b>AWG</b>	<b>18-4</b>		

<b>CSA (Use Group)</b>	<b>B</b>	<b>C</b>	<b>D</b>
Rated voltage	V	600	600
Rated current	A	57	57
AWG conductor	AWG	18-4	

<b>General data</b>		
Type of insulation material		Wemid (PA)
UL 94 flammability rating		V-0

Contact base material		
Material of contact surface		

Pin dimensions = d	mm	1.2, Octagonal
Solder eyelet Ø = D	mm	1.6
Solder eyelet Ø tolerance	mm	+ 0,1

Product data

IEC: 1000 V / 76 A / 0.5 - 16 mm<sup>2</sup>  
 UL: 600 V / 57 A / AWG 18 - 4



For additional articles and information, refer to [catalog.weidmuller.com](http://catalog.weidmuller.com)

Note:

- Additional colours on request
- Rated current related to rated cross-section & min. No. of poles.
- Wire end ferrule without plastic collar to DIN 46228/1
- Wire end ferrule with plastic collar to DIN 46228/4
- P on drawing = pitch
- Rated data refer only to the component itself. Clearance and creepage distances to other components are to be designed in accordance with the relevant application standards.
- The test point can only be used as potential-pickup point.

LUF5 10.00/./180



Dimensioned drawing

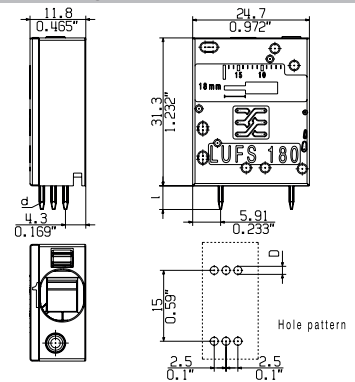

Ordering data

Solder pin length	5 mm			
Colour	Black			
<b>Pitch</b>	<b>10.00 mm</b>			
Pol.	L1	(inch)	Qty.	Order No.
1	0.00	0.000	50	<b>2491810000</b>

Representative deratings curve

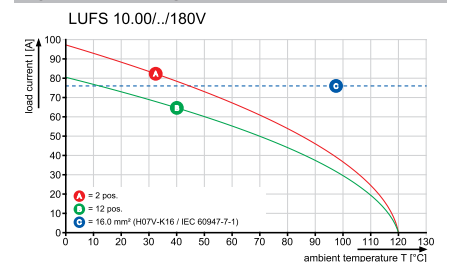

LUF5 10.00/./180V

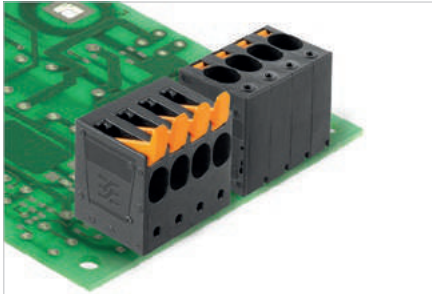

High-performance PCB terminal with PUSH IN connection system for wire cross-sections up to 16 mm<sup>2</sup>.

- Fast connection thanks to a pusher for opening the contact point, or direct insertion
- Securely closed contact point: with the "Connection Safety Concept" the conductor is always clamped securely
- Integrated test point for test plug PS 2.0
- Increased derating reserves through the use of WEMID insulating material
- Wire outlet direction and activation in 180° version

Technical data

In compliance with IEC 60664-1 / IEC 61984

Clamping range, max.	mm <sup>2</sup>	0.5...16
<b>Solid core H05(07) V-U</b>	<b>mm<sup>2</sup></b>	<b>0.5...16</b>
Stranded H07 V-R	mm <sup>2</sup>	6...16
Flexible H05(07) V-K	mm <sup>2</sup>	0.5...16
Flexible with ferrule	mm <sup>2</sup>	0.5...16
Ferrule with plastic collar	mm <sup>2</sup>	0.5...16
Stripping length	mm	18
Screwdriver blade	mm	0.8 x 4.0

According to norm

Tightening torque range			
<b>Rated current, max.</b>	<b>A</b>	<b>76</b>	<b>76</b>
At ambient temperature		20°C	40°C

For conductor cross-section			
Overvoltage category		III	III
Pollution severity		3	2
		2	2

<b>Rated voltage</b>	<b>V</b>	<b>1000</b>	<b>1000</b>	<b>1000</b>
Rated impulse voltage	kV	8	8	6

UL / CUL (Use Group)

<b>Rated voltage</b>	<b>V</b>	<b>600</b>	<b>600</b>	<b>600</b>
<b>Rated current</b>	<b>A</b>	<b>57</b>	<b>57</b>	<b>5</b>
<b>AWG conductor</b>	<b>AWG</b>	<b>18-4</b>		

CSA (Use Group)

<b>Rated voltage</b>	<b>V</b>	<b>600</b>	<b>600</b>	<b>600</b>
<b>Rated current</b>	<b>A</b>	<b>57</b>	<b>57</b>	<b>5</b>
<b>AWG conductor</b>	<b>AWG</b>	<b>18-4</b>		

General data

Type of insulation material		Wemid (PA)
UL 94 flammability rating		V-0
Contact base material		tinned
Material of contact surface		tinned
Pin dimensions = d	mm	1.2, Octagonal
Solder eyelet Ø = D	mm	1.6
Solder eyelet Ø tolerance	mm	+ 0,1

Product data

IEC: 1000 V / 76 A / 0.5 - 16 mm<sup>2</sup>  
 UL: 600 V / 57 A / AWG 18 - 4



For additional articles and information, refer to [catalog.weidmuller.com](http://catalog.weidmuller.com)

Note:

- Additional colours on request
- Rated current related to rated cross-section & min. No. of poles.
- Wire end ferrule without plastic collar to DIN 46228/1
- Wire end ferrule with plastic collar to DIN 46228/4
- P on drawing = pitch
- Rated data refer only to the component itself. Clearance and creepage distances to other components are to be designed in accordance with the relevant application standards.
- The test point can only be used as potential-pickup point.

LUF5 10.00/./180V



Dimensioned drawing

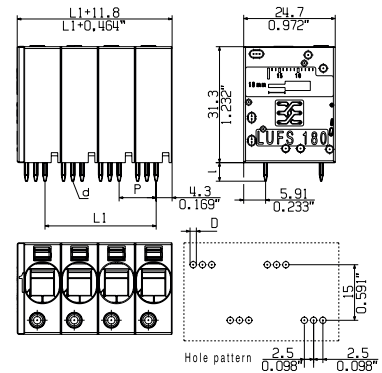

Accessories

Note: Refer to the Accessories chapter for additional accessories.

Screwdriver		Order No.
	SDIS 0.8X4.0X100	9008400000
	SDS 0.8X4.0X100	9008340000
Test plug		
	PS 2.0 MC	0310000000

Ordering data

Solder pin length	5 mm			
Colour	Black			
Pitch	10.00 mm			
Pol.	L1	(inch)	Qty.	Order No.
2	10.00	0.394	40	2492110000
3	20.00	0.787	40	2492120000
4	30.00	1.181	30	2492130000
5	40.00	1.575	25	2492140000
6	50.00	1.969	20	2492150000
7	60.00	2.362	10	2492160000
8	70.00	2.756	10	2492170000
9	80.00	3.150	10	2492180000
10	90.00	3.543	10	2492190000
11	100.00	3.937	10	2492200000
12	110.00	4.331	10	2492210000

Representative deratings curve

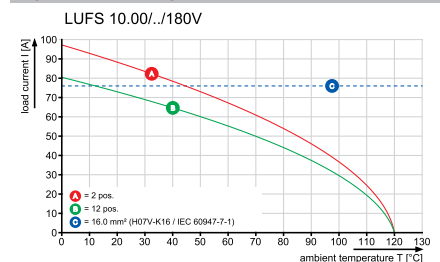

LUF 15.00/./90

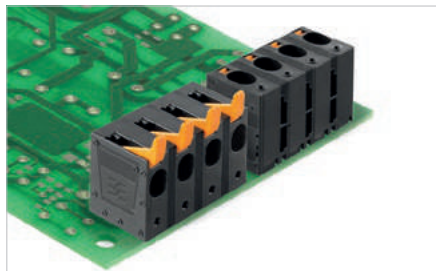

High-performance PCB terminal with PUSH IN connection system for wire cross-sections up to 16 mm<sup>2</sup> in 15.00 mm pitch

- Fast connection thanks to a pusher for opening the contact point, or direct insertion
- Securely closed contact point, with the "Connection Safety Concept" the conductor is always clamped securely
- Integrated test point for test plug PS 2.0
- Central tip test point for test probes on the upper side of the terminal
- Increased derating reserves through the use of WEMID insulating material
- Wire outlet direction and activation in 90° version

Technical data

In compliance with IEC 60664-1 / IEC 61984			
Clamping range, max.	mm <sup>2</sup>	0.5...16	
<b>Solid core H05(07) V-U</b>	<b>mm<sup>2</sup></b>	<b>0.5...16</b>	
Stranded H07 V-R	mm <sup>2</sup>	10...16	
Flexible H05(07) V-K	mm <sup>2</sup>	0.5...16	
Flexible with ferrule	mm <sup>2</sup>	0.5...16	
Ferrule with plastic collar	mm <sup>2</sup>	0.5...16	
Stripping length	mm	18	
Screwdriver blade	mm	0.8 x 4.0	
According to norm			
Tightening torque range			
<b>Rated current, max.</b>	<b>A</b>	<b>76</b>	<b>71</b>
At ambient temperature		20°C	40°C
For conductor cross-section		III	III
Overtoltage category		III	II
Pollution severity		3	2
<b>Rated voltage</b>	<b>V</b>	<b>1000</b>	<b>1000</b>
Rated impulse voltage	kV	8	8
<b>UL / CUL (Use Group)</b>		<b>B</b>	<b>C</b>
<b>Rated voltage</b>	<b>V</b>	<b>600</b>	<b>600</b>
<b>Rated current</b>	<b>A</b>	<b>61</b>	<b>5</b>
<b>AWG conductor</b>	<b>AWG</b>	<b>18-6</b>	
<b>CSA (Use Group)</b>		<b>B</b>	<b>C</b>
Rated voltage	V	600	600
Rated current	A	61	5
AWG conductor	AWG	18-6	
General data			
Type of insulation material		Wemid (PA)	
UL 94 flammability rating		V-0	
Contact base material		E-Cu	
Material of contact surface			
Pin dimensions = d	mm	1.2, Octagonal	
Solder eyelet Ø = D	mm	1.7	
Solder eyelet Ø tolerance	mm	+ 0,1	

Product data

IEC: 1000 V / 76 A / 0.5 - 16 mm<sup>2</sup>  
UL: 600 V / 61 A / AWG 18 - 6



For additional articles and information, refer to [catalog.weidmuller.com](http://catalog.weidmuller.com)

Note:

- Additional colours on request
- Rated current related to rated cross-section & min. No. of poles.
- Wire end ferrule without plastic collar to DIN 46228/1
- Wire end ferrule with plastic collar to DIN 46228/4
- P on drawing = pitch
- Rated data refer only to the component itself. Clearance and creepage distances to other components are to be designed in accordance with the relevant application standards.
- The test point can only be used as potential-pickup point.

LUF 15.00/./90



Dimensioned drawing

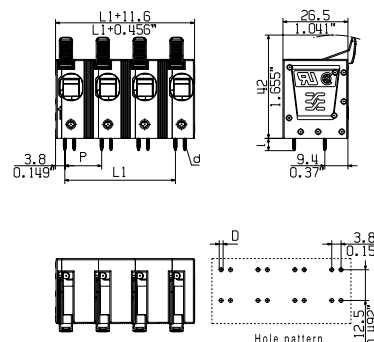

Accessories

Note: Refer to the Accessories chapter for additional accessories.

Screwdriver		Order No.
	SDIS 0.8X4.0X100	9008400000
	SDS 0.8X4.0X100	9008340000
Test plug		
	PS 2.0 MC	0310000000

Ordering data

Solder pin length		5 mm		
Colour		Black		
Pitch		15.00 mm		
Pol.	L1	(inch)	Qty.	Order No.
2	15.00	0.590	40	2491800000
3	30.00	1.181	30	2491900000
4	45.00	1.772	25	2491910000
5	60.00	2.362	20	2491920000
6	75.00	2.953	10	2491930000
7	90.00	3.543	10	2491940000
8	105.00	4.134	10	2491950000

15.00

90°

16 mm<sup>2</sup>

Representative deratings curve

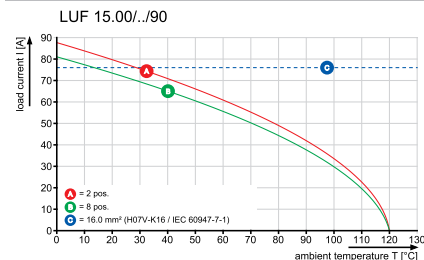

LUF 15.00/.. /90V

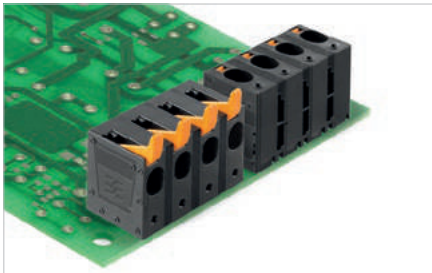

High-performance PCB terminal with PUSH IN connection system for wire cross-sections up to 16 mm<sup>2</sup> in 15.00 mm pitch

- Fast connection without tools thanks to an operating lever for opening the contact point, or direct insertion
- Securely closed contact point, with the "Connection Safety Concept" the conductor is always clamped securely
- Integrated test point for test plug PS 2.0
- Central tip test point for test probes on the upper side of the terminal
- Increased derating reserves through the use of WEMID insulating material
- Wire outlet direction: 90° version

Technical data

In compliance with IEC 60664-1 / IEC 61984			
Clamping range, max.	mm <sup>2</sup>	0.5...16	
<b>Solid core H05(07) V-U</b>	<b>mm<sup>2</sup></b>	<b>0.5...16</b>	
Stranded H07 V-R	mm <sup>2</sup>	10...16	
Flexible H05(07) V-K	mm <sup>2</sup>	0.5...16	
Flexible with ferrule	mm <sup>2</sup>	0.5...16	
Ferrule with plastic collar	mm <sup>2</sup>	0.5...16	
Stripping length	mm	18	
Screwdriver blade	mm	0.8 x 4.0	
According to norm			
Tightening torque range			
<b>Rated current, max.</b>	<b>A</b>	<b>68</b>	<b>62</b>
At ambient temperature		20°C	40°C
For conductor cross-section			
Overvoltage category		III	III II
Pollution severity		3	2 2
<b>Rated voltage</b>	<b>V</b>	<b>1000</b>	<b>1000 1000</b>
Rated impulse voltage	kV	8	8 8
<b>UL / CUL (Use Group)</b>		<b>B</b>	<b>C D</b>
<b>Rated voltage</b>	<b>V</b>	<b>600</b>	<b>600 600</b>
<b>Rated current</b>	<b>A</b>	<b>58</b>	<b>58 5</b>
<b>AWG conductor</b>	<b>AWG</b>	<b>18-6</b>	
<b>CSA (Use Group)</b>		<b>B</b>	<b>C D</b>
Rated voltage	V	600	600 600
Rated current	A	58	58 5
AWG conductor	AWG	18-6	
<b>General data</b>			
Type of insulation material		Wemid (PA)	
UL 94 flammability rating		V-0	
Contact base material		E-Cu	
Material of contact surface			
Pin dimensions = d	mm	1.2, Octagonal	
Solder eyelet Ø = D	mm	1.7	
Solder eyelet Ø tolerance	mm	+ 0,1	

Product data

IEC: 1000 V / 68 A / 0.5 - 16 mm<sup>2</sup>  
 UL: 600 V / 58 A / AWG 18 - 6



For additional articles and information, refer to [catalog.weidmuller.com](http://catalog.weidmuller.com)

Note:

- Additional colours on request
- Rated current related to rated cross-section & min. No. of poles.
- Wire end ferrule without plastic collar to DIN 46228/1
- Wire end ferrule with plastic collar to DIN 46228/4
- P on drawing = pitch
- Rated data refer only to the component itself. Clearance and creepage distances to other components are to be designed in accordance with the relevant application standards.
- The test point can only be used as potential-pickup point.

LUF 15.00/.. /90V



Dimensioned drawing

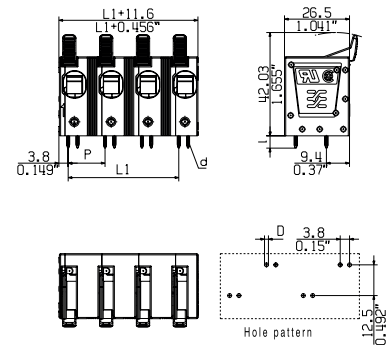

Accessories

Note: Refer to the Accessories chapter for additional accessories.

Screwdriver		Order No.
	SDIS 0.8X4.0X100	9008400000
	SDS 0.8X4.0X100	9008340000
Test plug		
	PS 2.0 MC	0310000000

Ordering data

Solder pin length		5 mm		
Colour		Black		
Pitch		15.00 mm		
Pol.	L1	(inch)	Qty.	Order No.
2	15.00	0.590	40	2492000000
3	30.00	1.181	30	2492010000
4	45.00	1.772	25	2492020000
5	60.00	2.362	20	2492030000
6	75.00	2.953	10	2492040000
7	90.00	3.543	10	2492050000
8	105.00	4.134	10	2492060000

Representative deratings curve

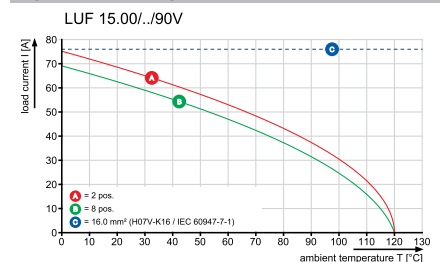

LUFS 15.00/./90V

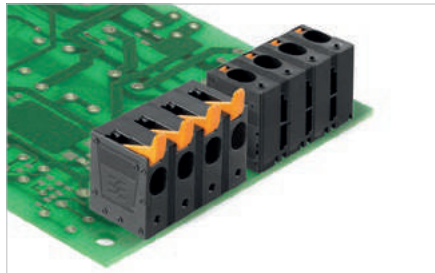

High-performance PCB terminal with PUSH IN connection system for wire cross-sections up to 16 mm<sup>2</sup> in 15.00 mm pitch

- Fast connection thanks to a pusher for opening the contact point, or direct insertion
- Securely closed contact point, with the "Connection Safety Concept" the conductor is always clamped securely
- Integrated test point for test plug PS 2.0
- Central tip test point for test probes on the upper side of the terminal
- Increased derating reserves through the use of WEMID insulating material
- Wire outlet direction and activation in 90° version

Technical data

In compliance with IEC 60664-1 / IEC 61984

Clamping range, max.	mm <sup>2</sup>	0.5...16	
<b>Solid core H05(07) V-U</b>	<b>mm<sup>2</sup></b>	<b>0.5...16</b>	
Stranded H07 V-R	mm <sup>2</sup>	10...16	
Flexible H05(07) V-K	mm <sup>2</sup>	0.5...16	
Flexible with ferrule	mm <sup>2</sup>	0.5...16	
Ferrule with plastic collar	mm <sup>2</sup>	0.5...16	
Stripping length	mm	18	
Screwdriver blade	mm	0.8 x 4.0	

According to norm

Tightening torque range			
<b>Rated current, max.</b>	<b>A</b>	<b>76</b>	<b>76</b>
At ambient temperature		20°C	40°C

For conductor cross-section		III	III	II
Overtoltage category		3	2	2
Pollution severity		3	2	2

<b>Rated voltage</b>	<b>V</b>	<b>1000</b>	<b>1000</b>	<b>1000</b>
Rated impulse voltage	kV	8	8	8

<b>UL / CUL (Use Group)</b>	<b>B</b>	<b>C</b>	<b>D</b>
-----------------------------	----------	----------	----------

<b>Rated voltage</b>	<b>V</b>	<b>600</b>	<b>600</b>	<b>600</b>
----------------------	----------	------------	------------	------------

<b>Rated current</b>	<b>A</b>	<b>53</b>	<b>53</b>	<b>5</b>
----------------------	----------	-----------	-----------	----------

<b>AWG conductor</b>	<b>AWG</b>	<b>18-4</b>		
----------------------	------------	-------------	--	--

<b>CSA (Use Group)</b>	<b>B</b>	<b>C</b>	<b>D</b>
------------------------	----------	----------	----------

Rated voltage	V	600	600	600
---------------	---	-----	-----	-----

Rated current	A	53	53	5
---------------	---	----	----	---

AWG conductor	AWG	18-4		
---------------	-----	------	--	--

General data

Type of insulation material		Wemid (PA)
UL 94 flammability rating		V-0
Contact base material		E-Cu
Material of contact surface		
Pin dimensions = d	mm	1.2, Octagonal
Solder eyelet Ø = D	mm	1.7
Solder eyelet Ø tolerance	mm	+ 0,1

Product data

IEC: 1000 V / 76 A / 0.5 - 16 mm<sup>2</sup>  
 UL: 600 V / 53 A / AWG 18 - 4



For additional articles and information, refer to [catalog.weidmueller.com](http://catalog.weidmueller.com)

Note:

- Additional colours on request
- Rated current related to rated cross-section & min. No. of poles.
- Wire end ferrule without plastic collar to DIN 46228/1
- Wire end ferrule with plastic collar to DIN 46228/4
- P on drawing = pitch
- Rated data refer only to the component itself. Clearance and creepage distances to other components are to be designed in accordance with the relevant application standards.
- The test point can only be used as potential-pickup point.

LUFS 15.00/./90V



Dimensioned drawing

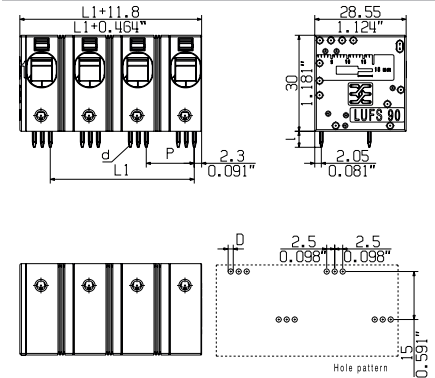

Accessories

Note: Refer to the Accessories chapter for additional accessories.

Screwdriver		Order No.
	SDIS 0.8X4.0X100	9008400000
	SDS 0.8X4.0X100	9008340000
Test plug		
	PS 2.0 MC	0310000000

Ordering data

Solder pin length	5 mm			
Colour	Black			
<b>Pitch</b>	<b>15.00 mm</b>			
Pol.	L1	(inch)	Qty.	Order No.
2	15.00	0.590	40	2499440000
3	30.00	1.181	30	2500570000
4	45.00	1.772	25	2500580000
5	60.00	2.362	20	2500590000
6	75.00	2.953	10	2500660000
7	90.00	3.543	10	2500600000
8	105.00	4.134	10	2500610000

Representative deratings curve

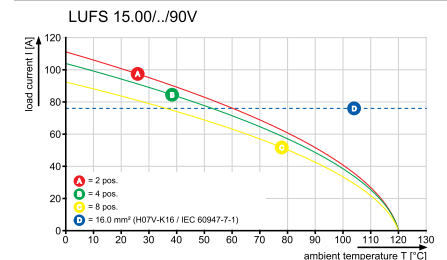

LUFS 15.00/./180V

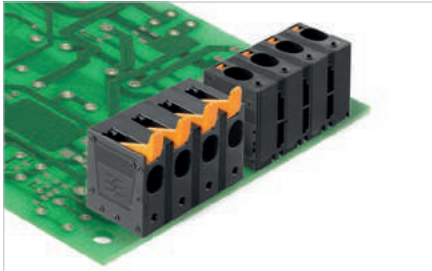

High-performance PCB terminal with PUSH IN connection system for wire cross-sections up to 16 mm<sup>2</sup> in 15.00 mm pitch

- Fast connection thanks to a pusher for opening the contact point, or direct insertion
- Securely closed contact point: with the "Connection Safety Concept" the conductor is always clamped securely
- Integrated test point for test plug PS 2.0
- Increased derating reserves through the use of WEMID insulating material
- Wire outlet direction and activation in 180° version

Technical data

In compliance with IEC 60664-1 / IEC 61984

Clamping range, max.	mm <sup>2</sup>	0.5...16
<b>Solid core H05(07) V-U</b>	<b>mm<sup>2</sup></b>	<b>0.5...16</b>
Stranded H07 V-R	mm <sup>2</sup>	10...16
Flexible H05(07) V-K	mm <sup>2</sup>	0.5...16
Flexible with ferrule	mm <sup>2</sup>	0.5...16
Ferrule with plastic collar	mm <sup>2</sup>	0.5...16
Stripping length	mm	18
Screwdriver blade	mm	0.8 x 4.0

According to norm

Tightening torque range			
<b>Rated current, max.</b>	<b>A</b>	<b>76</b>	<b>76</b>
At ambient temperature		20°C	40°C
For conductor cross-section			
Overtoltage category		III	III
Pollution severity		3	2
		2	2

<b>Rated voltage</b>	<b>V</b>	<b>1000</b>	<b>1000</b>	<b>1000</b>
Rated impulse voltage	kV	8	8	6

UL / CUL (Use Group)

<b>Rated voltage</b>	<b>V</b>	<b>600</b>	<b>600</b>	<b>600</b>
<b>Rated current</b>	<b>A</b>	<b>57</b>	<b>57</b>	<b>5</b>
<b>AWG conductor</b>	<b>AWG</b>	<b>18-4</b>		

CSA (Use Group)

<b>Rated voltage</b>	<b>V</b>	<b>600</b>	<b>600</b>	<b>600</b>
<b>Rated current</b>	<b>A</b>	<b>57</b>	<b>57</b>	<b>5</b>
<b>AWG conductor</b>	<b>AWG</b>	<b>18-4</b>		

General data

Type of insulation material		Wemid (PA)
UL 94 flammability rating		V-0
Contact base material		E-Cu
Material of contact surface		
Pin dimensions = d	mm	1.2, Octagonal
Solder eyelet Ø = D	mm	1.7
Solder eyelet Ø tolerance	mm	+ 0,1

Product data

IEC: 1000 V / 76 A / 0.5 - 16 mm<sup>2</sup>  
 UL: 600 V / 57 A / AWG 18 - 4



For additional articles and information, refer to [catalog.weidmuller.com](http://catalog.weidmuller.com)

Note:

- Additional colours on request
- Rated current related to rated cross-section & min. No. of poles.
- Wire end ferrule without plastic collar to DIN 46228/1
- Wire end ferrule with plastic collar to DIN 46228/4
- P on drawing = pitch
- Rated data refer only to the component itself. Clearance and creepage distances to other components are to be designed in accordance with the relevant application standards.
- The test point can only be used as potential-pickup point.

LUFS 15.00/./180V



Dimensioned drawing

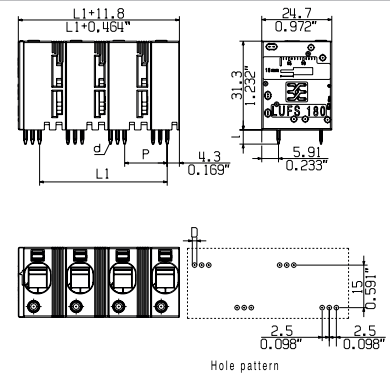

Accessories

Note: Refer to the Accessories chapter for additional accessories.

Screwdriver		Order No.
	SDIS 0.8X4.0X100	9008400000
	SDS 0.8X4.0X100	9008340000
Test plug		
	PS 2.0 MC	0310000000

Ordering data

Solder pin length	5 mm			
Colour	Black			
Pitch	15.00 mm			
Pol.	L1	(inch)	Qty.	Order No.
2	15.00	0.590	40	2491820000
3	30.00	1.181	30	2492220000
4	45.00	1.772	25	2492230000
5	60.00	2.362	20	2492240000
6	75.00	2.953	10	2492250000
7	90.00	3.543	10	2492260000
8	105.00	4.134	10	2492270000

Representative deratings curve

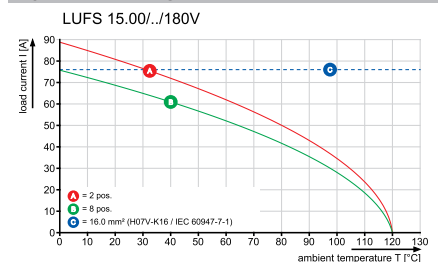





# OMNIMATE® Power PCB connectors

**OMNIMATE® Power  
PCB connectors**

OMNIMATE® Power		
	Explanation	K.2
OMNIMATE® Power Hybrid		
	Explanation	K.4
	Quick selection	K.6
	Product selection	K.8
OMNIMATE® Power IT		
	Explanation	K.46
	Quick selection	K.50
	Product selection	K.52
OMNIMATE® Power HP to 2.5 mm <sup>2</sup> / 24 A		
	Explanation	K.76
	Quick selection	K.80
	Product selection	K.82
OMNIMATE® Power HP to 6 mm <sup>2</sup> / 41 A		
	Explanation	K.100
	Quick selection	K.108
	Product selection	K.110
OMNIMATE® Power HP 16 mm <sup>2</sup> / 76 A		
	Explanation	K.180
	Quick selection	K.184
	Product selection	K.186



## OMNIMATE® Power on BOARD

### Integrated connection systems delivering innovative drive applications

The OMNIMATE® Power system excels in power electronics and drive applications because it has implemented and incorporated customer and market requirements.

Custom-fit connection solutions for power electronics – resulting from the synergy between application-oriented components, individual services and competent design-in support.

The following pages show why OMNIMATE® Power is the ideal system for power electronics and drive applications. This system has benefited from our broader perspective of component directives and our consistent implementation of requests from the market and customers.

#### Performance + Innovation

Designed with future requirements in mind whether for cars or servo-drives: hybrid design concepts create an efficient solution from two distinct elements.

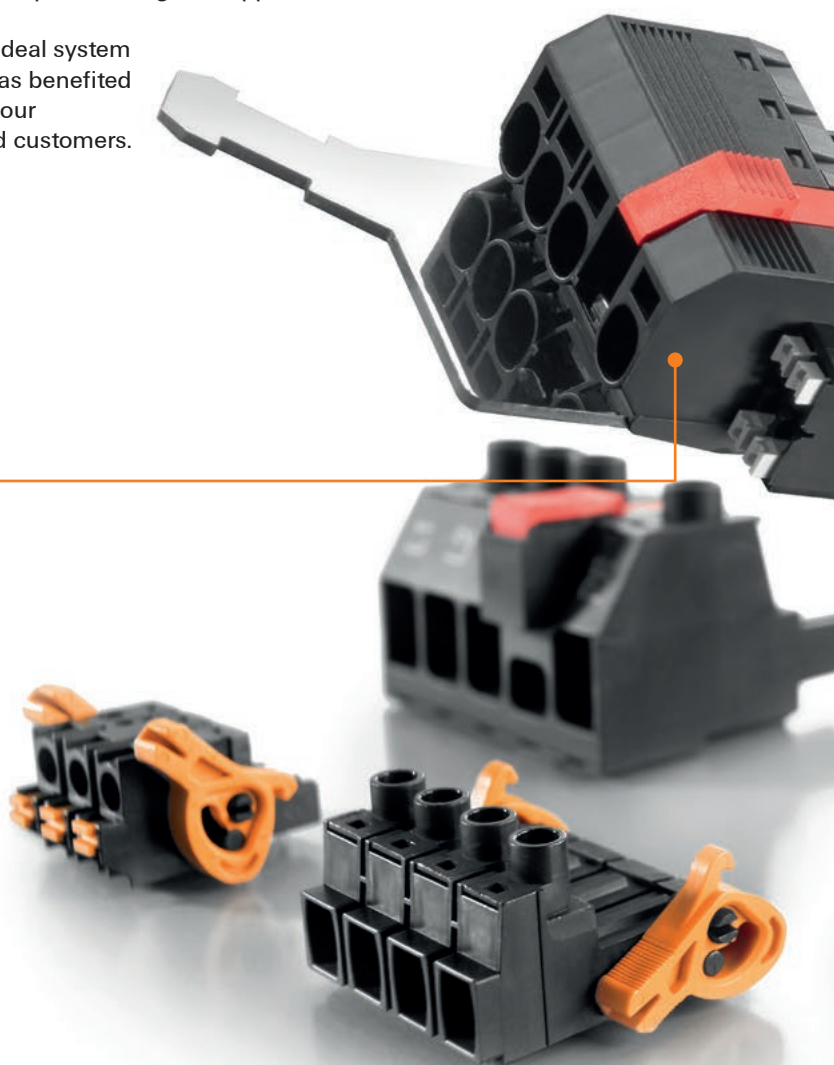
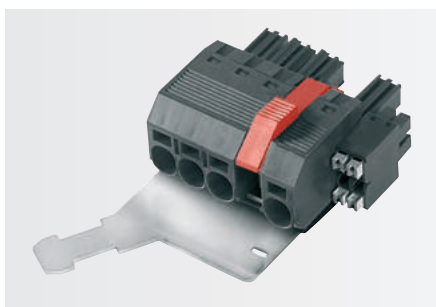

**Performance + Support**

Weidmüller delivers more than just components. Our design-in competence encompassing work from design and implementation to the market release phase delivers the top results.

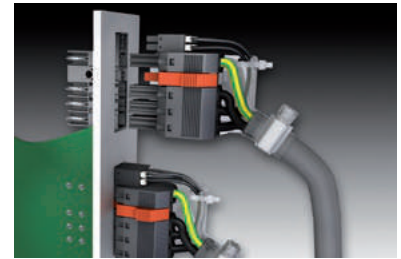
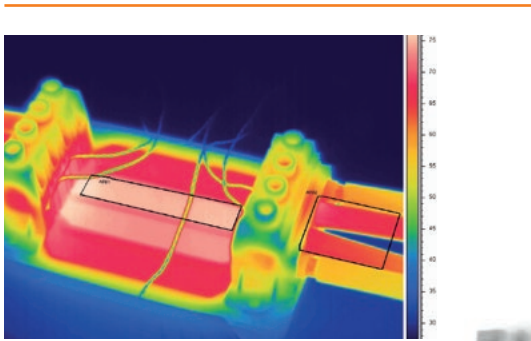

**An overview of OMNIMATE® Power**

The single-source solution that omits no necessary components a result of Weidmüller's technology and application expertise delivers the optimal designed-in results. The following pages describe the individual product lines in detail.

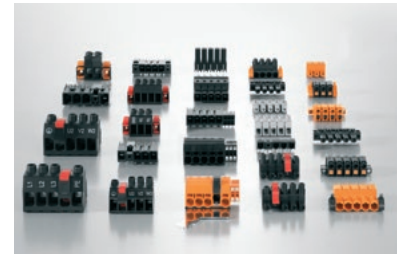

**Design-In Services & Support**

The path to top results starts before component selection and does not end with delivery. More information can be found at <http://galaxy.weidmueller.com>

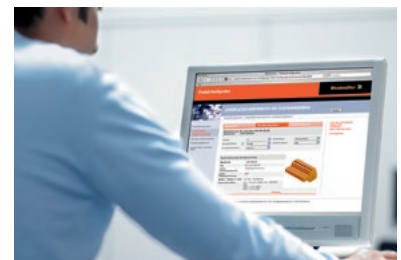

**Performance + Services**

Customised services supplement our comprehensive standard portfolio. The housing colour, printing, coding, contact surfaces, packaging and much more can be configured online with just a few mouse clicks.

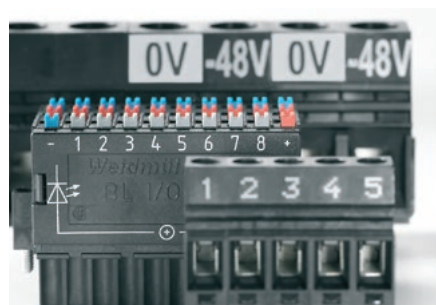

# OMNIMATE® Power BV/SV 7.62HP Hybrid – for power, signals and EMC

## Three functions in one!

The OMNIMATE® Power Hybrid connector provides developers and users with the perfect three-in-one solution.

The hybrid motor connector can simultaneously connect power, signals and a pluggable EMC shield. This allows you to save space on the circuit board, on the outside of the housing and in the electrical cabinet. The self-locking one-handed interlock mechanism requires only one plugging step and thus speeds up installation and maintenance procedures. It is easy to handle and interlocks automatically – even in difficult installation positions. The unique shielding shape with 30° cable entry enables a space savings of up to 10 cm between rows.

### Unique safety

Safe, EMC-compliant shield connection for any application situation and with no risk of error.

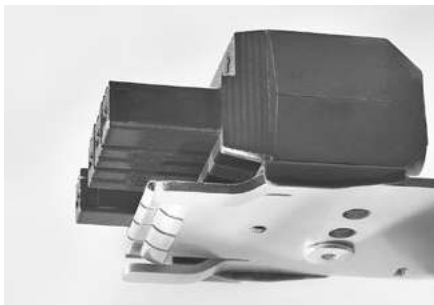

### Unique integration

Three-in-one solution: pluggable shield support, integrated signal contacts, and one-handed security flange.

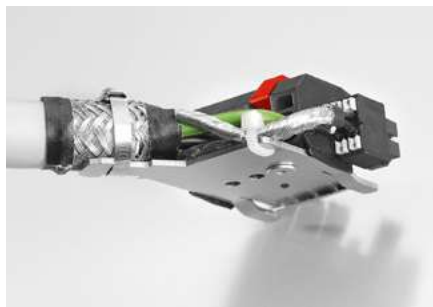

### Unique component density

Higher packaging density and more space in the housing wall and on the printed-circuit board due to as much as 38 % space savings in the construction width.

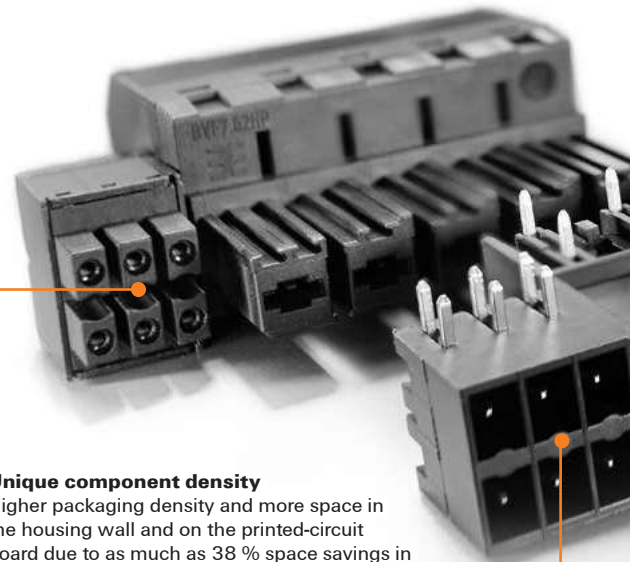
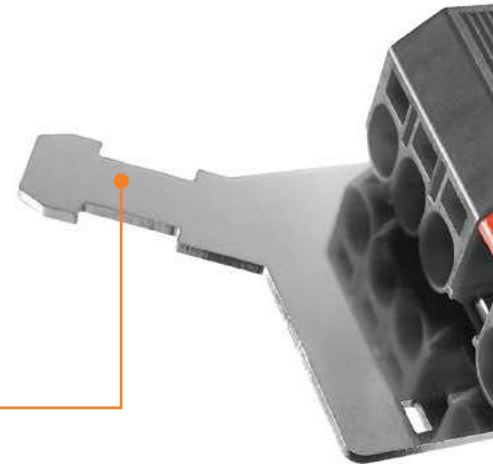
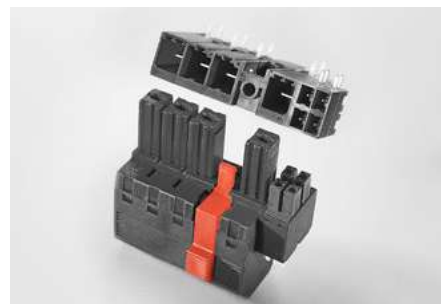

**Unique interaction**

Plug & Work with intuitive handling: featuring tool-free one-handed operation with automatic snap-in and also “blind” plugging of power, signals and shielding simultaneously.

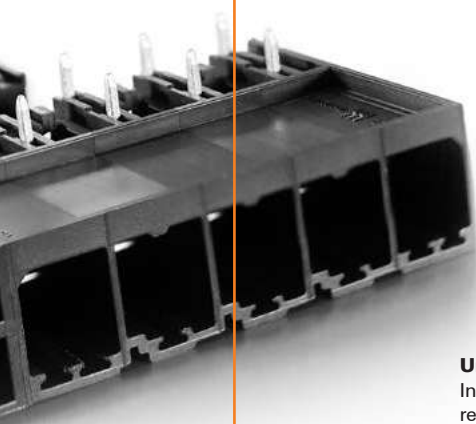
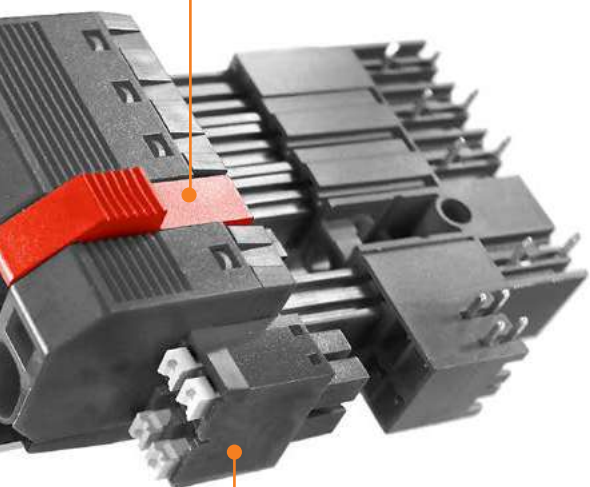

**Unique innovation**

Integrating functions, optimising processes, and reducing complexity: The conventional 2 outer flanges have simply been replaced by 1 middle flange, 4 signal contacts and 1 pluggable shield support.

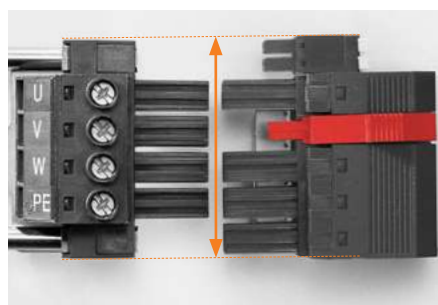

**EMC in theory and in the real world**

The motor feedback (signal feedback from temperature/encoder) in hybrid, shield-within-shield motor cables is usually made from over-sized power contacts or from disconnected I/O connectors. It also normally requires two separate shield connections. During installation and repairs (replacement), it is possible that the shield terminals could be incorrectly connected, left disconnected or lost. With conventional shielding, it can be quite difficult to tighten the flange screws when the connection is located at a difficult to reach location. So this step is often neglected in the real world.

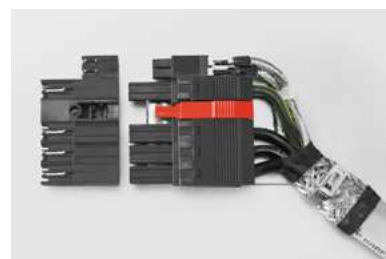

**Reliably avoiding interferences**

As a result, malfunctions can then be caused by the coupling of electromagnetic fields within the sensitive electronics. The pluggable, hybrid shield support features a special EMC spring-contact strip which ensures that the shield connection to the housing is permanent, vibration-proof and covers a large surface area. It allows the shielding braid from the power and signal wires to be connected separately – and enables this to be done automatically in one step so that it is not dependent on the user.



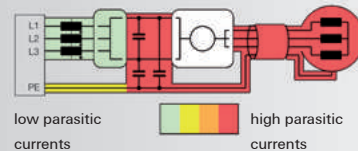

Topology of parasitic currents



Source: Fraunhofer IZM



<http://www.OMNIMATE.net>

-  = Wire-to-Board
-  = Board-to-Board
-  = Wire-to-Wire
-  = Board-to-Wire

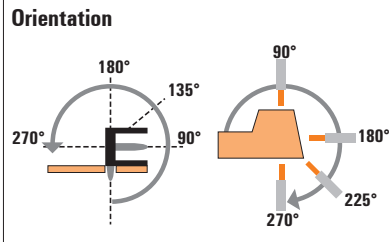
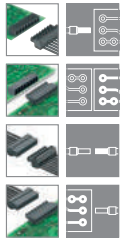

Hybrid pin header

Hybrid pin header







Solder connection

Solder connection



**BV/SV 7.62 series**



		Type	SV-SMT & SC 3.81	SV & SC 3.81
		Orientation	90° / 270°	90° / 270°
		Flange options	G/MF/MSF	G/MF/MSF
		Product code numbers	IEC: 1000V / 41A UL: 300V / 35A	IEC: 1000V / 41A UL: 200V / 35A
Hybrid female connector  PUSH IN		<b>BVF &amp; BC 3.81</b> 180° (G)/MF/MSF IEC: 1000V / 41A / 0.2-10mm <sup>2</sup> UL: 600V / 35A / AWG 24-8	<input type="radio"/>	<input type="radio"/>
		<b>BVFL &amp; BC 3.81</b> 180° (G)/MF/MSF IEC: 1000V / 41A / 0.2-6mm <sup>2</sup> UL: 600V / 35A / AWG 24-8	<input type="radio"/>	<input type="radio"/>
Hybrid female connector  PUSH IN		<b>BVF &amp; BC 3.81*</b> 180° (G)/MF/MSF IEC: 1000V / 41A / 0.2-10mm <sup>2</sup> UL: 600V / 35A / AWG 24-8	<input type="radio"/>	<input type="radio"/>
		<b>BVFL &amp; BC 3.81*</b> 180° (G)/MF/MSF IEC: 1000V / 41A / 0.2-6mm <sup>2</sup> UL: 600V / 35A / AWG 24-8	<input type="radio"/>	<input type="radio"/>

\* pluggable shield support as an accessory or fitted in advance by us

- G** = Closed (without flange)
- MF** = Centre flange for clasp
- MSF** = middle flange with screw and latching hook



**Connectors in 7.62 mm pitch**  
**Series BV/SV 7.62 - connection up to 6 mm<sup>2</sup>**

**SV-SMT../90 & SC 3.81**

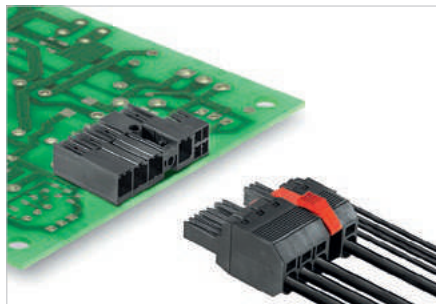

Hybrid male header with 90° outlet direction with power and signal contacts. Fulfills the enhanced requirements for 3 mm of finger safety on 400 V TNC(S) systems in accordance with IEC 61800-5-1 and allows UL approval for 600 V in accordance with UL61800-5-1/UL840. The self-locking middle flange reduces the space requirements by one pitch width in comparison with conventional solutions.

Variants: middle flange and middle screw flange fastening.

The high-temperature-resistant OMNIMATE® Power male header with THR (through-hole reflow) technology, suitable for the SMT process.

**Product data**

IEC: 1000 V / 41 A

UL:



For additional articles and information, refer to [catalog.weidmuller.com](http://catalog.weidmuller.com)

**Note:**

- Technical specifications refer to the power contacts
- Technical data of signal contacts: 50V / 5A, stripping length 8mm
- Rated current related to rated cross-section & min. No. of poles.
- Specifications of diagram: P1=7.62 mm; P2=3.81 mm
- Rated data refer only to the component itself. Clearance and creepage distances to other components are to be designed in accordance with the relevant application standards.

**SV-SMT../90 & SC 3.81**



**Dimensioned drawing**

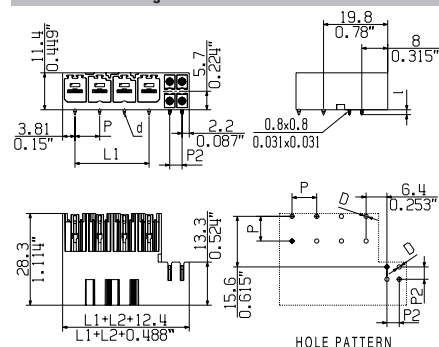

**Technical data**

**In compliance with IEC 60664-1 / IEC 61984**

Clamping range, max.			
<b>Solid core H05(07) V-U</b>			
Stranded H07 V-R			
Flexible H05(07) V-K			
Flexible with ferrule			
Ferrule with plastic collar			
Stripping length			
Screwdriver blade	mm		
According to norm			
Tightening torque range			
<b>Rated current, max.</b>	<b>A</b>	<b>41</b>	<b>41</b>
At ambient temperature		20°C	40°C
For conductor cross-section			
Overtoltage category		III	III II
Pollution severity		3	2 2
<b>Rated voltage</b>	<b>V</b>	<b>630</b>	<b>630 1000</b>
Rated impulse voltage	kV	6	6 6
<b>UL / CUL (Use Group)</b>		<b>B</b>	<b>C D</b>

<b>Rated voltage</b>			
<b>Rated current</b>			
<b>AWG conductor</b>	<b>AWG</b>		
<b>CSA (Use Group)</b>		<b>B</b>	<b>C D</b>
Rated voltage			
Rated current			
AWG conductor	AWG		

<b>General data</b>			
Type of insulation material		PA GF	
UL 94 flammability rating		V-0	
Contact base material		Copper alloy	
Material of contact surface		tinned	
Pin dimensions = d	mm	0.8 x 1.0	
Solder eyelet Ø = D	mm	1.3	
Solder eyelet Ø tolerance	mm	+ 0,1	

**Accessories**

**Note:** Refer to the Accessories chapter for additional accessories.

Coding	Order No.
BV/SV 7.62HP K0	1937590000



**Ordering data**

Solder pin length		2.6 mm	
Colour		Black	
Pitch		7.62 mm	
Poles	L1 (inch)	L2 (inch)	Qty. Order No.
2 / 4	7.62	0.300	3.81 0.150 78 <b>2528950000</b>
2 / 6	7.62	0.300	11.43 0.450 66 <b>2529030000</b>
2 / 8	7.62	0.300	11.43 0.450 60 <b>2529040000</b>
3 / 4	15.24	0.600	3.81 0.150 60 <b>2529050000</b>
3 / 6	15.24	0.600	11.43 0.450 54 <b>2529060000</b>
3 / 8	15.24	0.600	11.43 0.450 48 <b>2529070000</b>
4 / 4	22.86	0.900	3.81 0.150 48 <b>2529080000</b>
4 / 6	22.86	0.900	11.43 0.450 42 <b>2529090000</b>
4 / 8	22.86	0.900	11.43 0.450 42 <b>2529100000</b>
5 / 4	30.48	1.200	3.81 0.150 36 <b>2529110000</b>
5 / 6	30.48	1.200	11.43 0.450 36 <b>2529120000</b>
5 / 8	30.48	1.200	11.43 0.450 30 <b>2529130000</b>





**Connectors in 7.62 mm pitch**  
**Series BV/SV 7.62 - connection up to 6 mm<sup>2</sup>**

**SV-SMT../90 & SC 3.81 MF**

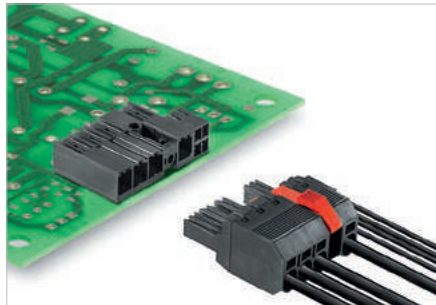

Hybrid male header with 90° outlet direction with power and signal contacts. Fulfills the enhanced requirements for 3 mm of finger safety on 400 V TNC(S) systems in accordance with IEC 61800-5-1 and allows UL approval for 600 V in accordance with UL61800-5-1/UL840. The self-locking middle flange reduces the space requirements by one pitch width in comparison with conventional solutions.

Variants: middle flange and middle screw flange fastening.

The high-temperature-resistant OMNIMATE® Power male header with THR (through-hole reflow) technology, suitable for the SMT process.

**Product data**

IEC: 1000 V / 41 A  
 UL:



For additional articles and information, refer to [catalog.weidmuller.com](http://catalog.weidmuller.com)

**Note:**

- Technical specifications refer to the power contacts
- Technical data of signal contacts: 50V / 5A, stripping length 8mm
- Rated current related to rated cross-section & min. No. of poles.
- Specifications of diagram: P1=7.62 mm; P2=3.81 mm
- Rated data refer only to the component itself. Clearance and creepage distances to other components are to be designed in accordance with the relevant application standards.
- MFX and MSFX: X= Position of the middle flange e.g. MF2, MSF3

**SV-SMT../90 & SC 3.81 MF2**



**Dimensioned drawing**

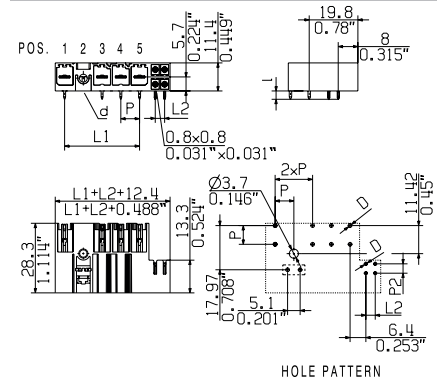

**Technical data**

**In compliance with IEC 60664-1 / IEC 61984**

Clamping range, max.			
<b>Solid core H05(07) V-U</b>			
Stranded H07 V-R			
Flexible H05(07) V-K			
Flexible with ferrule			
Ferrule with plastic collar			
Stripping length			
Screwdriver blade	mm		
According to norm			
Tightening torque range			
<b>Rated current, max.</b>	<b>A</b>	<b>41</b>	<b>41</b>
At ambient temperature		20°C	40°C
For conductor cross-section			
Overtoltage category		III	III
Pollution severity		3	2
<b>Rated voltage</b>	<b>V</b>	<b>630</b>	<b>630</b>
Rated impulse voltage	kV	6	6
<b>UL / CUL (Use Group)</b>		<b>B</b>	<b>C</b>

<b>Rated voltage</b>			
<b>Rated current</b>			
<b>AWG conductor</b>	<b>AWG</b>		
<b>CSA (Use Group)</b>		<b>B</b>	<b>C</b>

Rated voltage		
Rated current		
AWG conductor	AWG	-

<b>General data</b>		
Type of insulation material		PA GF
UL 94 flammability rating		V-0
Contact base material		Copper alloy
Material of contact surface		tinned
Pin dimensions = d	mm	0.8 x 1.0
Solder eyelet Ø = D	mm	1.3
Solder eyelet Ø tolerance	mm	+ 0,1

**Accessories**

**Note:** Refer to the Accessories chapter for additional accessories.

Coding	Order No.
BV/SV 7.62HP K0	1937590000



**Ordering data**

Solder pin length		2.6 mm				
Colour		Black				
Pitch		7.62 mm				
Poles	L1 (inch)	L2 (inch)	Qty.	Order No.		
2 / 4	15.24	0.600	3.81	0.150	60	2529000000
2 / 6	15.24	0.600	7.62	0.300	54	2529720000
2 / 8	15.24	0.600	11.43	0.450	48	2529730000
3 / 4	22.86	0.900	3.81	0.150	48	2529740000
3 / 6	22.86	0.900	7.62	0.300	42	2529750000
3 / 8	22.86	0.900	11.43	0.450	36	2529760000
4 / 4	30.48	1.200	3.81	0.150	36	2626800000
4 / 6	30.48	1.200	7.62	0.300	36	2626850000
4 / 8	30.48	1.200	11.43	0.450	30	2626860000
5 / 4	38.10	1.500	3.81	0.150	30	2626870000
5 / 6	38.10	1.500	7.62	0.300	30	2626880000
5 / 8	38.10	1.500	11.43	0.450	24	2626890000

SV-SMT../90 & SC 3.81 MF3



Dimensioned drawing

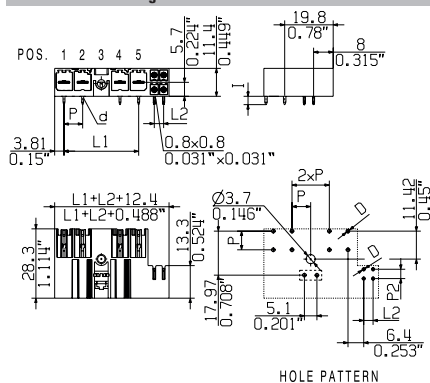

Ordering data

Solder pin length		2.6 mm		
Colour		Black		
Pitch		7.62 mm		
Poles	L1 (inch)	L2 (inch)	Qty.	Order No.
3/4	22.86	0.900	3.81 0.150	48 <b>2529770000</b>
3/6	22.86	0.900	7.62 0.300	42 <b>2529780000</b>
3/8	22.86	0.900	11.43 0.450	36 <b>2529790000</b>
4/4	30.48	1.200	3.81 0.150	36 <b>2626900000</b>
4/6	30.48	1.200	7.62 0.300	36 <b>2626910000</b>
4/8	30.48	1.200	11.43 0.450	30 <b>2626920000</b>
5/4	38.10	1.500	3.81 0.150	30 <b>2529830000</b>
5/6	38.10	1.500	7.62 0.300	30 <b>2529840000</b>
5/8	38.10	1.500	11.43 0.450	30 <b>2529850000</b>

SV-SMT../90 & SC 3.81 MF4



Dimensioned drawing

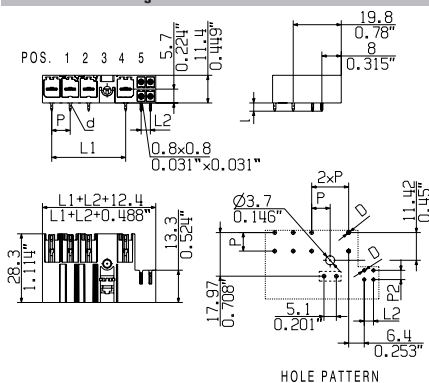

Ordering data

Solder pin length		2.6 mm		
Colour		Black		
Pitch		7.62 mm		
Poles	L1 (inch)	L2 (inch)	Qty.	Order No.
4/4	30.48	1.200	3.81 0.150	36 <b>2529800000</b>
4/6	30.48	1.200	7.62 0.300	36 <b>2529810000</b>
4/8	30.48	1.200	11.43 0.450	30 <b>2529820000</b>
5/4	38.10	1.500	3.81 0.150	30 <b>2529860000</b>
5/6	38.10	1.500	7.62 0.300	30 <b>2529870000</b>
5/8	38.10	1.500	11.43 0.450	30 <b>2529880000</b>

**Connectors in 7.62 mm pitch**  
**Series BV/SV 7.62 - connection up to 6 mm<sup>2</sup>**

**SV-SMT/..90 & SC 3.81 MSF**

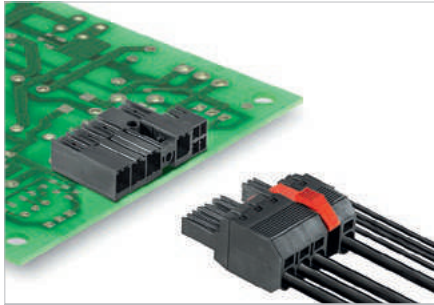

Hybrid male header with 90° outlet direction with power and signal contacts. Fulfills the enhanced requirements for 3 mm of finger safety on 400 V TNC(S) systems in accordance with IEC 61800-5-1 and allows UL approval for 600 V in accordance with UL61800-5-1/UL840. The self-locking middle flange reduces the space requirements by one pitch width in comparison with conventional solutions.

Variants: middle flange and middle screw flange fastening.

The high-temperature-resistant OMNIMATE® Power male header with THR (through-hole reflow) technology, suitable for the SMT process.

**Product data**

IEC: 1000 V / 41 A  
 UL:



For additional articles and information, refer to [catalog.weidmueller.com](http://catalog.weidmueller.com)

**Note:**

- Technical specifications refer to the power contacts
- Technical data of signal contacts: 50V / 5A, stripping length 8mm
- Rated current related to rated cross-section & min. No. of poles.
- Specifications of diagram: P1=7.62 mm; P2=3.81 mm
- Rated data refer only to the component itself. Clearance and creepage distances to other components are to be designed in accordance with the relevant application standards.
- MFX and MSFX: X= Position of the middle flange e.g. MF2, MSF3

**SV-SMT/..90 & SC 3.81 MSF2**



**Dimensioned drawing**

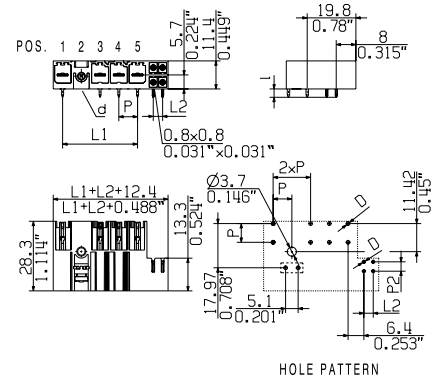

**Technical data**

**In compliance with IEC 60664-1 / IEC 61984**

Clamping range, max.			
<b>Solid core H05(07) V-U</b>			
Stranded H07 V-R			
Flexible H05(07) V-K			
Flexible with ferrule			
Ferrule with plastic collar			
Stripping length			
Screwdriver blade	mm		
According to norm			
Tightening torque range			
<b>Rated current, max.</b>	<b>A</b>	<b>41</b>	<b>41</b>
At ambient temperature		20°C	40°C
For conductor cross-section			
Overtoltage category		III	III II
Pollution severity		3	2 2
<b>Rated voltage</b>	<b>V</b>	<b>630</b>	<b>630 1000</b>
Rated impulse voltage	kV	6	6 6
<b>UL / CUL (Use Group)</b>		<b>B</b>	<b>C D</b>

<b>Rated voltage</b>			
<b>Rated current</b>			
<b>AWG conductor</b>	<b>AWG</b>		
<b>CSA (Use Group)</b>		<b>B</b>	<b>C D</b>

Rated voltage		
Rated current		
AWG conductor	AWG	-

<b>General data</b>		
Type of insulation material		PA GF
UL 94 flammability rating		V-0
Contact base material		Copper alloy
Material of contact surface		tinned
Pin dimensions = d	mm	0.8 x 1.0
Solder eyelet Ø = D	mm	1.3
Solder eyelet Ø tolerance	mm	+ 0,1

**Accessories**

**Note:** Refer to the Accessories chapter for additional accessories.

Coding	Order No.
BV/SV 7.62HP K0	1937590000



**Ordering data**

Solder pin length		2.6 mm	
Colour		Black	
Pitch		7.62 mm	
Poles	L1 (inch)	L2 (inch)	Qty. Order No.
2 / 4	15.24	0.600 3.81	0.150 60 <b>2529890000</b>
2 / 6	15.24	0.600 7.62	0.300 54 <b>2529900000</b>
2 / 8	15.24	0.600 11.43	0.450 48 <b>2529910000</b>
3 / 4	22.86	0.900 3.81	0.150 48 <b>2529920000</b>
3 / 6	22.86	0.900 7.62	0.300 42 <b>2529930000</b>
3 / 8	22.86	0.900 11.43	0.450 36 <b>2529940000</b>
4 / 4	30.48	1.200 3.81	0.150 36 <b>2626930000</b>
4 / 6	30.48	1.200 7.62	0.300 36 <b>2626940000</b>
4 / 8	30.48	1.200 11.43	0.450 30 <b>2626950000</b>
5 / 4	38.10	1.500 3.81	0.150 30 <b>2626960000</b>
5 / 6	38.10	1.500 7.62	0.300 30 <b>2626970000</b>
5 / 8	38.10	1.500 11.43	0.450 24 <b>2626980000</b>

SV-SMT../90 & SC 3.81 MSF3



Dimensioned drawing

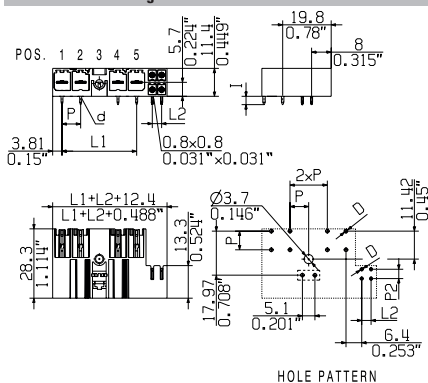

Ordering data

Solder pin length		2.6 mm			
Colour		Black			
Pitch		7.62 mm			
Poles	L1 (inch)	L2 (inch)	Qty.	Order No.	
3/4	22.86	0.900	3.81 0.150	48	2529950000
3/6	22.86	0.900	7.62 0.300	42	2529960000
3/8	22.86	0.900	11.43 0.450	36	2529970000
4/4	30.48	1.200	3.81 0.150	36	2626990000
4/6	30.48	1.200	7.62 0.300	36	2627000000
4/8	30.48	1.200	11.43 0.450	30	2627050000
5/4	38.10	1.500	3.81 0.150	30	2530010000
5/6	38.10	1.500	7.62 0.300	30	2530020000
5/8	38.10	1.500	11.43 0.450	30	2530030000

SV-SMT../90 & SC 3.81 MSF4



Dimensioned drawing

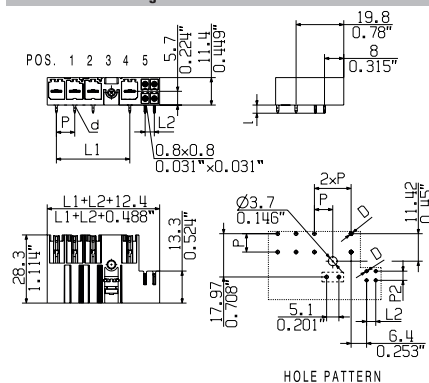

Ordering data

Solder pin length		2.6 mm			
Colour		Black			
Pitch		7.62 mm			
Poles	L1 (inch)	L2 (inch)	Qty.	Order No.	
4/4	30.48	1.200	3.81 0.150	36	2529980000
4/6	30.48	1.200	7.62 0.300	36	2529990000
4/8	30.48	1.200	11.43 0.450	30	2530000000
5/4	38.10	1.500	3.81 0.150	30	2530040000
5/6	38.10	1.500	7.62 0.300	30	2530050000
5/8	38.10	1.500	11.43 0.450	30	2530060000

**Connectors in 7.62 mm pitch**  
**Series BV/SV 7.62 - connection up to 6 mm<sup>2</sup>**

**SV-SMT../270 & SC 3.81**

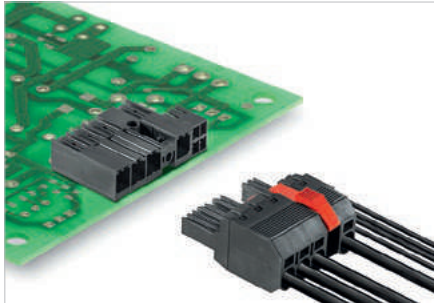

Hybrid male header with 270° outlet direction with power and signal contacts. Fulfills the enhanced requirements for 3 mm of finger safety on 400 V TNC(S) systems in accordance with IEC 61800-5-1 and allows UL approval for 600 V in accordance with UL61800-5-1/UL840. The self-locking middle flange reduces the space requirements by one pitch width in comparison with conventional solutions.

Variants: middle flange and middle screw flange fastening.

The high-temperature-resistant OMNIMATE® Power male header with THR (through-hole reflow) technology, suitable for the SMT process.

**Product data**

IEC: 1000 V / 41 A  
 UL:



For additional articles and information, refer to [catalog.weidmuller.com](http://catalog.weidmuller.com)

**Note:**

- Technical specifications refer to the power contacts
- Technical data of signal contacts: 50V / 5A, stripping length 8mm
- Rated current related to rated cross-section & min. No. of poles.
- Specifications of diagram: P1=7.62 mm; P2=3.81 mm
- Rated data refer only to the component itself. Clearance and creepage distances to other components are to be designed in accordance with the relevant application standards.

**SV-SMT../270 & SC 3.81**



**Dimensioned drawing**

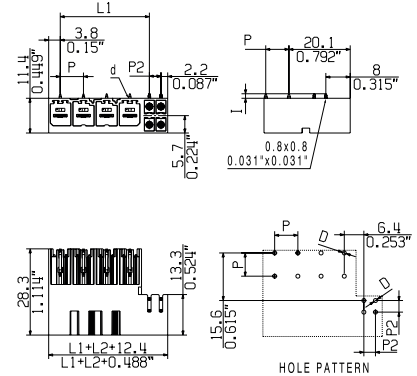

**Technical data**

**In compliance with IEC 60664-1 / IEC 61984**

Clamping range, max.			
<b>Solid core H05(07) V-U</b>			
Stranded H07 V-R			
Flexible H05(07) V-K			
Flexible with ferrule			
Ferrule with plastic collar			
Stripping length			
Screwdriver blade	mm		
According to norm			
Tightening torque range			
<b>Rated current, max.</b>	<b>A</b>	<b>41</b>	<b>41</b>
At ambient temperature		20°C	40°C
For conductor cross-section			
Overtoltage category		III	III II
Pollution severity		3	2 2
<b>Rated voltage</b>	<b>V</b>	<b>630</b>	<b>630 1000</b>
Rated impulse voltage	kV	6	6 6
<b>UL / CUL (Use Group)</b>		<b>B</b>	<b>C D</b>

<b>Rated voltage</b>			
<b>Rated current</b>			
<b>AWG conductor</b>	<b>AWG</b>		
<b>CSA (Use Group)</b>		<b>B</b>	<b>C D</b>
Rated voltage			
Rated current			
AWG conductor	AWG		

<b>General data</b>			
Type of insulation material		PA GF	
UL 94 flammability rating		V-0	
Contact base material		Copper alloy	
Material of contact surface		tinned	
Pin dimensions = d	mm	0.8 x 1.0	
Solder eyelet Ø = D	mm	1.3	
Solder eyelet Ø tolerance	mm	+ 0,1	

**Accessories**

**Note:** Refer to the Accessories chapter for additional accessories.

Coding	Order No.
BV/SV 7.62HP KO	1937590000



**Ordering data**

Solder pin length		2.6 mm	
Colour		Black	
Pitch		7.62 mm	
Poles	L1 (inch)	L2 (inch)	Qty. Order No.
2 / 4	7.62	0.300 3.81	0.150 66 <b>2528970000</b>
2 / 6	7.62	0.300 11.43	0.450 66 <b>2529260000</b>
2 / 8	7.62	0.300 11.43	0.450 60 <b>2529270000</b>
3 / 4	15.24	0.600 3.81	0.150 60 <b>2529280000</b>
3 / 6	15.24	0.600 11.43	0.450 54 <b>2529290000</b>
3 / 8	15.24	0.600 11.43	0.450 48 <b>2529300000</b>
4 / 4	22.86	0.900 3.81	0.150 48 <b>2529310000</b>
4 / 6	22.86	0.900 11.43	0.450 42 <b>2529320000</b>
4 / 8	22.86	0.900 11.43	0.450 42 <b>2529330000</b>
5 / 4	30.48	1.200 3.81	0.150 36 <b>2529340000</b>
5 / 6	30.48	1.200 11.43	0.450 36 <b>2529350000</b>
5 / 8	30.48	1.200 11.43	0.450 36 <b>2529360000</b>



**Connectors in 7.62 mm pitch**  
**Series BV/SV 7.62 - connection up to 6 mm<sup>2</sup>**

**SV-SMT../270 & SC 3.81 MF**

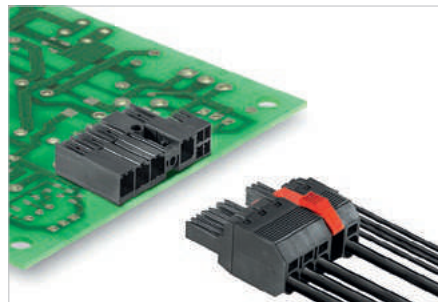

Hybrid male header with 270° outlet direction with power and signal contacts. Fulfills the enhanced requirements for 3 mm of finger safety on 400 V TNC(S) systems in accordance with IEC 61800-5-1 and allows UL approval for 600 V in accordance with UL61800-5-1/UL840. The self-locking middle flange reduces the space requirements by one pitch width in comparison with conventional solutions.

Variants: middle flange and middle screw flange fastening.

The high-temperature-resistant OMNIMATE® Power male header with THR (through-hole reflow) technology, suitable for the SMT process.

**Product data**

IEC: 1000 V / 41 A

UL:



For additional articles and information, refer to [catalog.weidmueller.com](http://catalog.weidmueller.com)

**Note:**

- Technical specifications refer to the power contacts
- Technical data of signal contacts: 50V / 5A, stripping length 8mm
- Rated current related to rated cross-section & min. No. of poles.
- Specifications of diagram: P1=7.62 mm; P2=3.81 mm
- Rated data refer only to the component itself. Clearance and creepage distances to other components are to be designed in accordance with the relevant application standards.
- MFX and MSFX: X= Position of the middle flange e.g. MF2, MSF3

**SV-SMT../270 & SC 3.81 MF2**



**Dimensioned drawing**

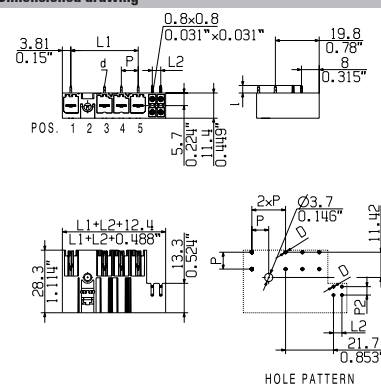

**Technical data**

**In compliance with IEC 60664-1 / IEC 61984**

Clamping range, max.			
<b>Solid core H05(07) V-U</b>			
Stranded H07 V-R			
Flexible H05(07) V-K			
Flexible with ferrule			
Ferrule with plastic collar			
Stripping length			
Screwdriver blade	mm		
According to norm			
Tightening torque range			
<b>Rated current, max.</b>	<b>A</b>	<b>41</b>	<b>41</b>
At ambient temperature		20°C	40°C
For conductor cross-section			
Overtoltage category		III	III II
Pollution severity		3	2 2
<b>Rated voltage</b>	<b>V</b>	<b>630</b>	<b>630 1000</b>
Rated impulse voltage	kV	6	6 6
<b>UL / CUL (Use Group)</b>		<b>B</b>	<b>C D</b>

<b>Rated voltage</b>			
<b>Rated current</b>			
<b>AWG conductor</b>	<b>AWG</b>		
<b>CSA (Use Group)</b>		<b>B</b>	<b>C D</b>

Rated voltage		
Rated current		
AWG conductor	AWG	-

<b>General data</b>		
Type of insulation material		PA GF
UL 94 flammability rating		V-0
Contact base material		Copper alloy
Material of contact surface		tinned
Pin dimensions = d	mm	0.8 x 1.0
Solder eyelet Ø = D	mm	1.3
Solder eyelet Ø tolerance	mm	+ 0,1

**Accessories**

**Note:** Refer to the Accessories chapter for additional accessories.

Coding	Order No.
BV/SV 7.62HP K0	1937590000



**Ordering data**

Solder pin length		2.6 mm	
Colour		Black	
Pitch		7.62 mm	
Poles	L1 (inch)	L2 (inch)	Qty. Order No.
2 / 4	15.24	0.600 3.81	0.150 60 <b>2529010000</b>
2 / 6	15.24	0.600 7.62	0.300 54 <b>2529370000</b>
2 / 8	15.24	0.600 11.43	0.450 48 <b>2529380000</b>
3 / 4	22.86	0.900 3.81	0.150 48 <b>2529390000</b>
3 / 6	22.86	0.900 7.62	0.300 42 <b>2529400000</b>
3 / 8	22.86	0.900 11.43	0.450 36 <b>2529410000</b>
4 / 4	30.48	1.200 3.81	0.150 36 <b>2627060000</b>
4 / 6	30.48	1.200 7.62	0.300 36 <b>2627090000</b>
4 / 8	30.48	1.200 11.43	0.450 30 <b>2627100000</b>
5 / 4	38.10	1.500 3.81	0.150 30 <b>2627110000</b>
5 / 6	38.10	1.500 7.62	0.300 30 <b>2627120000</b>
5 / 8	38.10	1.500 11.43	0.450 24 <b>2627130000</b>



SV-SMT../270 & SC 3.81 MF3



Dimensioned drawing

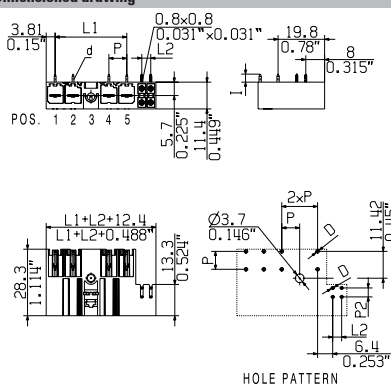

Ordering data

Solder pin length		2.6 mm		
Colour		Black		
Pitch		7.62 mm		
Poles	L1 (inch)	L2 (inch)	Qty.	Order No.
3/4	22.86	0.900	3.81 0.150 48	2529420000
3/6	22.86	0.900	7.62 0.300 42	2529430000
3/8	22.86	0.900	11.43 0.450 36	2529440000
4/4	30.48	1.200	3.81 0.150 36	2627140000
4/6	30.48	1.200	7.62 0.300 36	2627150000
4/8	30.48	1.200	11.43 0.450 30	2627160000
5/4	38.10	1.500	3.81 0.150 30	2529480000
5/6	38.10	1.500	7.62 0.300 30	2529490000
5/8	38.10	1.500	11.43 0.450 30	2529500000

SV-SMT../270 & SC 3.81 MF4



Dimensioned drawing

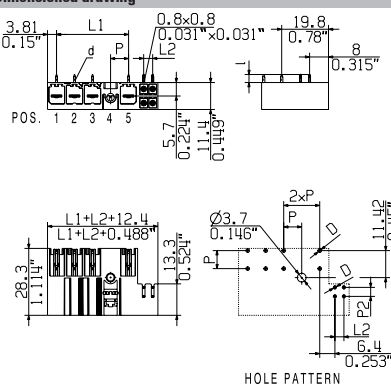

Ordering data

Solder pin length		2.6 mm		
Colour		Black		
Pitch		7.62 mm		
Poles	L1 (inch)	L2 (inch)	Qty.	Order No.
4/4	30.48	1.200	3.81 0.150 36	2529450000
4/6	30.48	1.200	7.62 0.300 36	2529460000
4/8	30.48	1.200	11.43 0.450 30	2529470000
5/4	38.10	1.500	3.81 0.150 30	2529510000
5/6	38.10	1.500	7.62 0.300 30	2529520000
5/8	38.10	1.500	11.43 0.450 30	2529530000

**Connectors in 7.62 mm pitch**  
**Series BV/SV 7.62 - connection up to 6 mm<sup>2</sup>**

**SV-SMT../270 & SC 3.81 MSF**

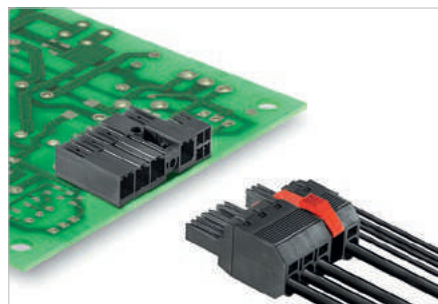

Hybrid male header with 270° outlet direction with power and signal contacts. Fulfils the enhanced requirements for 3 mm of finger safety on 400 V TNC(S) systems in accordance with IEC 61800-5-1 and allows UL approval for 600 V in accordance with UL61800-5-1/UL840. The self-locking middle flange reduces the space requirements by one pitch width in comparison with conventional solutions.

Variants: middle flange and middle screw flange fastening.

The high-temperature-resistant OMNIMATE® Power male header with THR (through-hole reflow) technology, suitable for the SMT process.

**Technical data**

**In compliance with IEC 60664-1 / IEC 61984**

Clamping range, max.			
<b>Solid core H05(07) V-U</b>			
Stranded H07 V-R			
Flexible H05(07) V-K			
Flexible with ferrule			
Ferrule with plastic collar			
Stripping length			
Screwdriver blade	mm		
According to norm			
Tightening torque range			
<b>Rated current, max.</b>	<b>A</b>	<b>41</b>	<b>41</b>
At ambient temperature		20°C	40°C
For conductor cross-section			
Overtoltage category		III	III II
Pollution severity		3	2 2
<b>Rated voltage</b>	<b>V</b>	<b>630</b>	<b>630 1000</b>
Rated impulse voltage	kV	6	6 6
<b>UL / CUL (Use Group)</b>		<b>B</b>	<b>C D</b>

<b>Rated voltage</b>			
<b>Rated current</b>			
<b>AWG conductor</b>	<b>AWG</b>		
<b>CSA (Use Group)</b>		<b>B</b>	<b>C D</b>

Rated voltage		
Rated current		
AWG conductor	AWG	-

<b>General data</b>		
Type of insulation material		PA GF
UL 94 flammability rating		V-0
Contact base material		Copper alloy
Material of contact surface		tinned
Pin dimensions = d	mm	0.8 x 1.0
Solder eyelet Ø = D	mm	1.3
Solder eyelet Ø tolerance	mm	+ 0,1

**Product data**

IEC: 1000 V / 41 A

UL:



For additional articles and information, refer to [catalog.weidmueller.com](http://catalog.weidmueller.com)

**Note:**

- Technical specifications refer to the power contacts
- Technical data of signal contacts: 50V / 5A, stripping length 8mm
- Rated current related to rated cross-section & min. No. of poles.
- Specifications of diagram: P1=7.62 mm; P2=3.81 mm
- Rated data refer only to the component itself. Clearance and creepage distances to other components are to be designed in accordance with the relevant application standards.
- MFX and MSFX: X= Position of the middle flange e.g. MF2, MSF3

**SV-SMT../270 & SC 3.81 MSF2**



**Dimensioned drawing**

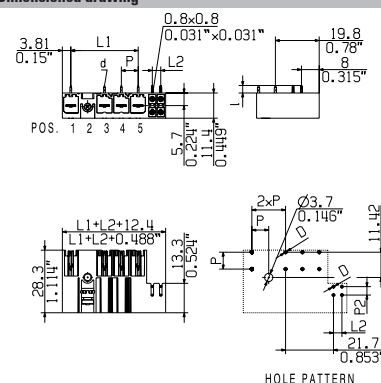

**Accessories**

**Note:** Refer to the Accessories chapter for additional accessories.

Coding	Order No.
BV/SV 7.62HP K0	1937590000

**Ordering data**

Solder pin length		2.6 mm	
Colour		Black	
Pitch 7.62 mm			
Poles	L1 (inch)	L2 (inch)	Qty. Order No.
2 / 4	15.24	0.600 3.81	0.150 60 <b>2529540000</b>
2 / 6	15.24	0.600 7.62	0.300 54 <b>2529550000</b>
2 / 8	15.24	0.600 11.43	0.450 48 <b>2529560000</b>
3 / 4	22.86	0.900 3.81	0.150 48 <b>2529570000</b>
3 / 6	22.86	0.900 7.62	0.300 42 <b>2529580000</b>
3 / 8	22.86	0.900 11.43	0.450 36 <b>2529590000</b>
4 / 4	30.48	1.200 3.81	0.150 36 <b>2627170000</b>
4 / 6	30.48	1.200 7.62	0.300 36 <b>2627180000</b>
4 / 8	30.48	1.200 11.43	0.450 30 <b>2627190000</b>
5 / 4	38.10	1.500 3.81	0.150 30 <b>2627200000</b>
5 / 6	38.10	1.500 7.62	0.300 30 <b>2627210000</b>
5 / 8	38.10	1.500 11.43	0.450 24 <b>2627220000</b>

SV-SMT../270 & SC 3.81 MSF3



Dimensioned drawing

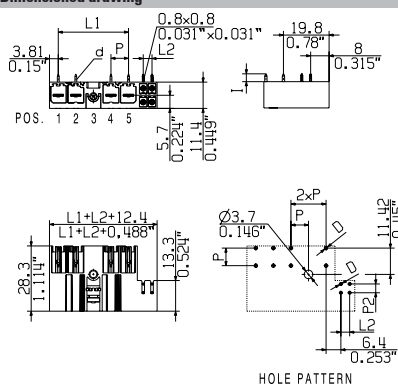

Ordering data

Solder pin length		2.6 mm		
Colour		Black		
Pitch		7.62 mm		
Poles	L1 (inch)	L2 (inch)	Qty.	Order No.
3/4	22.86	0.900	3.81 0.150	48 <b>2529600000</b>
3/6	22.86	0.900	7.62 0.300	42 <b>2529610000</b>
3/8	22.86	0.900	11.43 0.450	36 <b>2529620000</b>
4/4	30.48	1.200	3.81 0.150	30 <b>2627230000</b>
4/6	30.48	1.200	7.62 0.300	30 <b>2627240000</b>
4/8	30.48	1.200	11.43 0.450	24 <b>2627250000</b>
5/4	38.10	1.500	3.81 0.150	30 <b>2529660000</b>
5/6	38.10	1.500	7.62 0.300	30 <b>2529670000</b>
5/8	38.10	1.500	11.43 0.450	30 <b>2529680000</b>

SV-SMT../270 & SC 3.81 MSF4



Dimensioned drawing

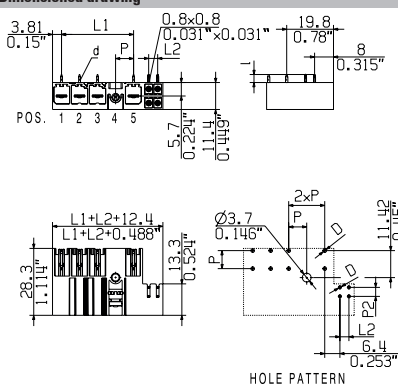

Ordering data

Solder pin length		2.6 mm		
Colour		Black		
Pitch		7.62 mm		
Poles	L1 (inch)	L2 (inch)	Qty.	Order No.
4/4	30.48	1.200	3.81 0.150	36 <b>2529630000</b>
4/6	30.48	1.200	7.62 0.300	36 <b>2529640000</b>
4/8	30.48	1.200	11.43 0.450	30 <b>2529650000</b>
5/4	38.10	1.500	3.81 0.150	30 <b>2529690000</b>
5/6	38.10	1.500	7.62 0.300	30 <b>2529700000</b>
5/8	38.10	1.500	11.43 0.450	30 <b>2529710000</b>

**Connectors in 7.62 mm pitch**  
**Series BV/SV 7.62 - connection up to 6 mm<sup>2</sup>**

**SV 7.62HP../90 & SC 3.81**

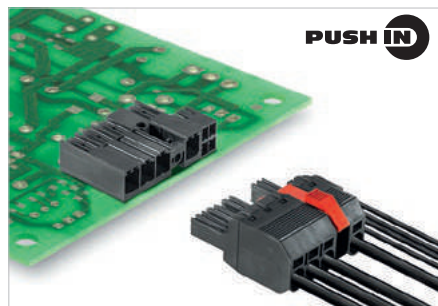

Hybrid male header with 90° outlet direction with power and signal contacts. Meets the enhanced requirements for 3 mm of touch safety for 400 V TNC(S) systems in acc. with IEC 61800-5-1 and comes with UL approval for 600 V in acc. with UL508-5-1 / UL840.

The self-locking middle flange reduces the space requirements by one pitch width compared to conventional solutions.

Variants: flange, screw flange, middle flange and middle screw flange fastening.

**Product data**

IEC: 1000 V / 41 A  
 UL: 300 V / 35 A



For additional articles and information, refer to [catalog.weidmuller.com](http://catalog.weidmuller.com)

**Note:**

- Technical specifications refer to the power contacts
- Technical data of signal contacts: 50V / 5A, stripping length 8mm
- Rated current related to rated cross-section & min. No. of poles.
- Specifications of diagram: P1=7.62 mm; P2=3.81 mm
- Rated data refer only to the component itself. Clearance and creepage distances to other components are to be designed in accordance with the relevant application standards.

**SV 7.62HP../90 SC../R**



**Dimensioned drawing**

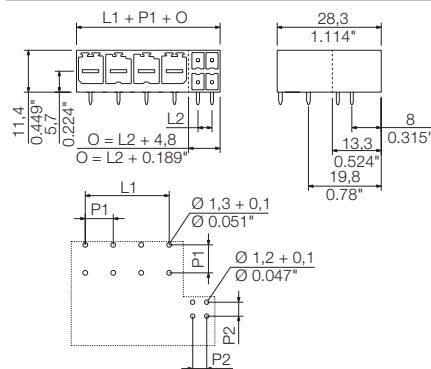

**Technical data**

**In compliance with IEC 60664-1 / IEC 61984**

Clamping range, max.			
<b>Solid core H05(07) V-U</b>			
Stranded H07 V-R			
Flexible H05(07) V-K			
Flexible with ferrule			
Ferrule with plastic collar			
Stripping length			
Screwdriver blade	mm		
According to norm			
Tightening torque range			
<b>Rated current, max.</b>	<b>A</b>	<b>41</b>	<b>41</b>
At ambient temperature		20°C	40°C
For conductor cross-section			
Overtoltage category		III	III II
Pollution severity		3	2 2
<b>Rated voltage</b>	<b>V</b>	<b>630</b>	<b>630 1000</b>
Rated impulse voltage	kV	6	6 6
<b>UL / CUL (Use Group)</b>		<b>B</b>	<b>C D</b>

<b>Rated voltage</b>	<b>V</b>	<b>300</b>	<b>300</b>	<b>600</b>
<b>Rated current</b>	<b>A</b>	<b>35</b>	<b>35</b>	<b>5</b>
<b>AWG conductor</b>	<b>AWG</b>			
<b>CSA (Use Group)</b>		<b>B</b>	<b>C</b>	<b>D</b>
Rated voltage	V	300	300	600
Rated current	A	33	33	5
AWG conductor	AWG			

<b>General data</b>			
Type of insulation material		PA GF	
UL 94 flammability rating		V-0	
Contact base material		Copper alloy	
Material of contact surface		tinned	
Pin dimensions = d	mm	0.8 x 1.0	
Solder eyelet Ø = D	mm	1.3	
Solder eyelet Ø tolerance	mm	+ 0,1	

**Accessories**

**Note:** Refer to the Accessories chapter for additional accessories.

Coding	Order No.
BV/SV 7.62HP KO	1937590000



**Ordering data**

Solder pin length		3.5 mm				
Colour		Black				
Pitch		7.62 mm				
Poles	L1 (inch)	L2 (inch)	Qty.	Order No.		
2 / 4	7.62	0.300	3.81	0.150	78	1089840000
2 / 6	7.62	0.300	7.62	0.300	66	1089920000
2 / 8	7.62	0.300	11.43	0.450	60	1157040000
3 / 4	15.24	0.600	3.81	0.150	60	1090040000
3 / 6	15.24	0.600	7.62	0.300	54	1090120000
3 / 8	15.24	0.600	11.43	0.450	48	1157050000
4 / 4	22.86	0.900	3.81	0.150	48	1090280000
4 / 6	22.86	0.900	7.62	0.300	42	1090360000
4 / 8	22.86	0.900	11.43	0.450	42	1157380000
5 / 4	30.48	1.200	3.81	0.150	36	1090520000
5 / 6	30.48	1.200	7.62	0.300	36	1090590000
5 / 8	30.48	1.200	11.43	0.450	30	1157080000



**Connectors in 7.62 mm pitch**  
**Series BV/SV 7.62 - connection up to 6 mm<sup>2</sup>**

**SV 7.62HP/./90 & SC 3.81MF**

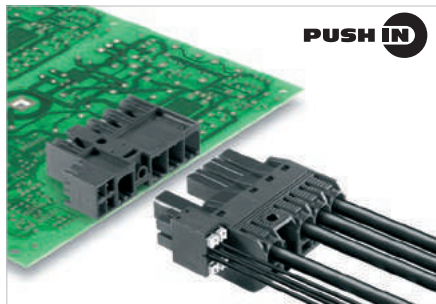

**PUSH IN**

Hybrid male header with 90° outlet direction with power and signal contacts. Meets the enhanced requirements for 3 mm of touch safety for 400 V TNC(S) systems in acc. with IEC 61800-5-1 and comes with UL approval for 600 V in acc. with UL508-5-1 / UL840.

The self-locking middle flange reduces the space requirements by one pitch width compared to conventional solutions.

Variants: flange, screw flange, middle flange and middle screw flange fastening.

**Product data**

IEC: 1000 V / 41 A  
 UL: 300 V / 35 A



For additional articles and information, refer to [catalog.weidmuller.com](http://catalog.weidmuller.com)

**Note:**

- Technical specifications refer to the power contacts
- Technical data of signal contacts: 50V / 5A, stripping length 8mm
- Rated current related to rated cross-section & min. No. of poles.
- Specifications of diagram: P1=7.62 mm; P2=3.81 mm
- Rated data refer only to the component itself. Clearance and creepage distances to other components are to be designed in accordance with the relevant application standards.
- MFX and MSFX: X= Position of the middle flange e.g. MF2, MSF3

**SV 7.62HP/./90MF2. SC/./R**



**Dimensioned drawing**

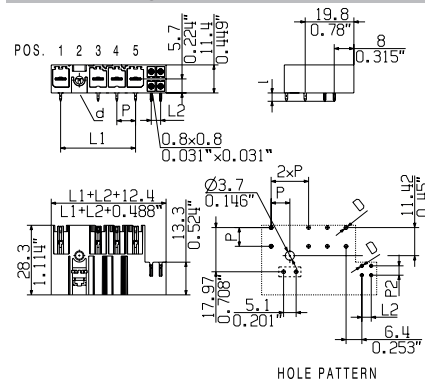

**Technical data**

**In compliance with IEC 60664-1 / IEC 61984**

Clamping range, max.			
<b>Solid core H05(07) V-U</b>			
Stranded H07 V-R			
Flexible H05(07) V-K			
Flexible with ferrule			
Ferrule with plastic collar			
Stripping length			
Screwdriver blade	mm		
According to norm			
Tightening torque range			
<b>Rated current, max.</b>	<b>A</b>	<b>41</b>	<b>41</b>
At ambient temperature		20°C	40°C
For conductor cross-section			
Overtoltage category		III	III II
Pollution severity		3	2 2
<b>Rated voltage</b>	<b>V</b>	<b>630</b>	<b>630 1000</b>
Rated impulse voltage	kV	6	6 6
<b>UL / CUL (Use Group)</b>		<b>B</b>	<b>C D</b>
<b>Rated voltage</b>	<b>V</b>	<b>300</b>	<b>300 600</b>
<b>Rated current</b>	<b>A</b>	<b>35</b>	<b>35 5</b>
<b>AWG conductor</b>	<b>AWG</b>		
<b>CSA (Use Group)</b>		<b>B</b>	<b>C D</b>
Rated voltage	V	300	300 600
Rated current	A	33	33 5
AWG conductor	AWG		
<b>General data</b>			
Type of insulation material		PA GF	
UL 94 flammability rating		V-0	
Contact base material		Copper alloy	
Material of contact surface		tinned	
Pin dimensions = d	mm	0.8 x 1.0	
Solder eyelet Ø = D	mm	1.3	
Solder eyelet Ø tolerance	mm	+ 0,1	

**Accessories**

**Note:** Refer to the Accessories chapter for additional accessories.

Coding	Order No.
BV/SV 7.62HP K0	1937590000



**Ordering data**

Solder pin length		3.5 mm	
Colour		Black	
Pitch 7.62 mm			
Poles	L1 (inch)	L2 (inch)	Qty. Order No.
2 / 4	15.24	0.600	3.81 0.150 60 <b>1089370000</b>
2 / 6	15.24	0.600	7.62 0.300 54 <b>1089410000</b>
2 / 8	15.24	0.600	11.43 0.450 48 <b>1156820000</b>
3 / 4	22.86	0.900	3.81 0.150 48 <b>1156230000</b>
3 / 6	22.86	0.900	7.62 0.300 42 <b>1156240000</b>
3 / 8	22.86	0.900	11.43 0.450 36 <b>1156840000</b>
4 / 4	30.48	1.200	3.81 0.150 36 <b>2627670000</b>
4 / 6	30.48	1.200	7.62 0.300 36 <b>2628150000</b>
4 / 8	30.48	1.200	11.43 0.450 30 <b>2628160000</b>
5 / 4	38.10	1.500	3.81 0.150 30 <b>2628170000</b>
5 / 6	38.10	1.500	7.62 0.300 30 <b>2628180000</b>
5 / 8	38.10	1.500	11.43 0.450 24 <b>2628190000</b>

SV 7.62HP../90MF3. SC../R



Dimensioned drawing

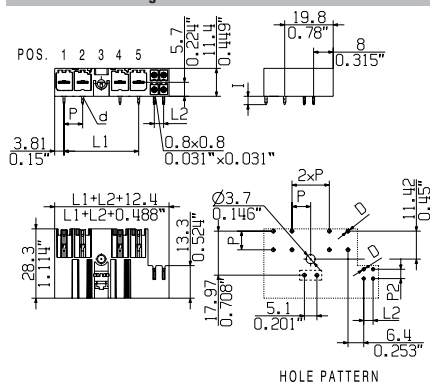

Ordering data

Solder pin length		3.5 mm					
Colour		Black					
Pitch		7.62 mm					
Poles	L1 (inch)	L2 (inch)	Qty.	Order No.			
3/4	22.86	0.900	3.81 0.150	48	1089660000		
3/6	22.86	0.900	7.62 0.300	42	1089730000		
3/8	22.86	0.900	11.43 0.450	36	1156850000		
4/4	30.48	1.200	3.81 0.150	36	2628200000		
4/6	30.48	1.200	7.62 0.300	36	2628210000		
4/8	30.48	1.200	11.43 0.450	30	2628220000		
5/4	38.10	1.500	3.81 0.150	30	1156910000		
5/6	38.10	1.500	7.62 0.300	30	1156930000		
5/8	38.10	1.500	11.43 0.450	30	1156950000		

SV 7.62HP../90MF4. SC../R



Dimensioned drawing

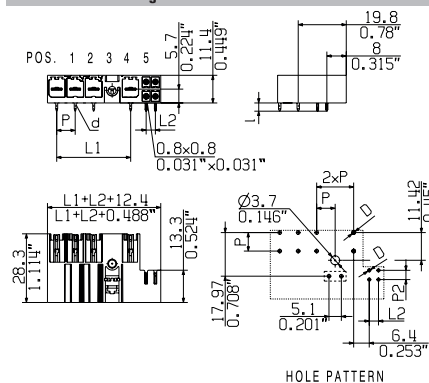

Ordering data

Solder pin length		3.5 mm					
Colour		Black					
Pitch		7.62 mm					
Poles	L1 (inch)	L2 (inch)	Qty.	Order No.			
4/4	30.48	1.200	3.81 0.150	36	1090130000		
4/6	30.48	1.200	7.62 0.300	36	1090210000		
4/8	30.48	1.200	11.43 0.450	30	1156890000		
5/4	38.10	1.500	3.81 0.150	30	1090600000		
5/6	38.10	1.500	7.62 0.300	30	1090670000		
5/8	38.10	1.500	11.43 0.450	30	1156980000		

**Connectors in 7.62 mm pitch**  
**Series BV/SV 7.62 - connection up to 6 mm<sup>2</sup>**

**SV 7.62HP../90 & SC 3.81MSF**

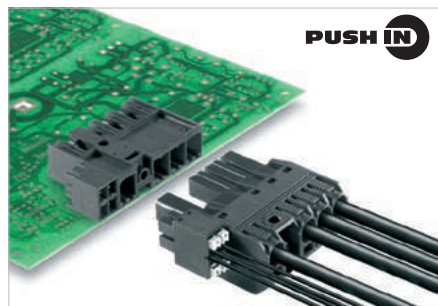

**PUSH IN**

Hybrid male header with 90° outlet direction with power and signal contacts. Meets the enhanced requirements for 3 mm of touch safety for 400 V TNC(S) systems in acc. with IEC 61800-5-1 and comes with UL approval for 600 V in acc. with UL508-5-1 / UL840.

The self-locking middle flange reduces the space requirements by one pitch width compared to conventional solutions.

Variants: flange, screw flange, middle flange and middle screw flange fastening.

**Technical data**

**In compliance with IEC 60664-1 / IEC 61984**

Clamping range, max.			
<b>Solid core H05(07) V-U</b>			
Stranded H07 V-R			
Flexible H05(07) V-K			
Flexible with ferrule			
Ferrule with plastic collar			
Stripping length			
Screwdriver blade	mm		
According to norm			
Tightening torque range			
<b>Rated current, max.</b>	<b>A</b>	<b>41</b>	<b>41</b>
At ambient temperature		20°C	40°C
For conductor cross-section			
Overtoltage category		III	III II
Pollution severity		3	2 2
<b>Rated voltage</b>	<b>V</b>	<b>630</b>	<b>630 1000</b>
Rated impulse voltage	kV	6	6 6
<b>UL / CUL (Use Group)</b>		<b>B</b>	<b>C D</b>
<b>Rated voltage</b>	<b>V</b>	<b>300</b>	<b>300 600</b>
<b>Rated current</b>	<b>A</b>	<b>35</b>	<b>35 5</b>
<b>AWG conductor</b>	<b>AWG</b>		-
<b>CSA (Use Group)</b>		<b>B</b>	<b>C D</b>
Rated voltage	V	300	300 600
Rated current	A	33	33 5
AWG conductor	AWG		-
<b>General data</b>			
Type of insulation material		PA GF	
UL 94 flammability rating		V-0	
Contact base material		Copper alloy	
Material of contact surface		tinned	
Pin dimensions = d	mm	0.8 x 1.0	
Solder eyelet Ø = D	mm	1.3	
Solder eyelet Ø tolerance	mm	+ 0,1	

**Product data**

IEC: 1000 V / 41 A  
 UL: 300 V / 35 A



For additional articles and information, refer to [catalog.weidmuller.com](http://catalog.weidmuller.com)

**Note:**

- Technical specifications refer to the power contacts
- Technical data of signal contacts: 50V / 5A, stripping length 8mm
- Rated current related to rated cross-section & min. No. of poles.
- Specifications of diagram: P1=7.62 mm; P2=3.81 mm
- Rated data refer only to the component itself. Clearance and creepage distances to other components are to be designed in accordance with the relevant application standards.
- MFX and MSFX: X= Position of the middle flange e.g. MF2, MSF3

**SV 7.62HP../90MSF2. SC../R**



**Dimensioned drawing**

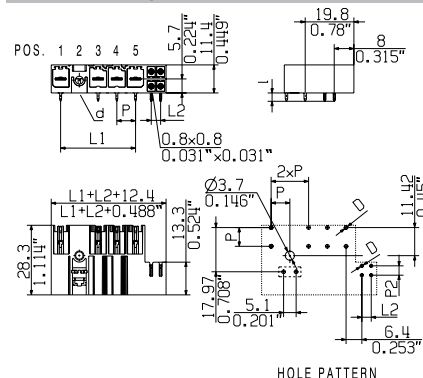

**Ordering data**

<b>Solder pin length</b>		<b>3.5 mm</b>		
<b>Colour</b>		<b>Black</b>		
<b>Pitch</b>		<b>7.62 mm</b>		
Poles	L1 (inch)	L2 (inch)	Qty.	Order No.
2 / 4	15.24	0.600	3.81 0.150	60 <b>1089510000</b>
2 / 6	15.24	0.600	7.62 0.300	54 <b>1089570000</b>
2 / 8	15.24	0.600	11.43 0.450	48 <b>1156830000</b>
3 / 4	22.86	0.900	3.81 0.150	48 <b>1156250000</b>
3 / 6	22.86	0.900	7.62 0.300	42 <b>1156270000</b>
3 / 8	22.86	0.900	11.43 0.450	36 <b>1156870000</b>
4 / 4	30.48	1.200	3.81 0.150	36 <b>2628230000</b>
4 / 6	30.48	1.200	7.62 0.300	36 <b>2628240000</b>
4 / 8	30.48	1.200	11.43 0.450	30 <b>2628250000</b>
5 / 4	38.10	1.500	3.81 0.150	30 <b>2628260000</b>
5 / 6	38.10	1.500	7.62 0.300	30 <b>2628270000</b>
5 / 8	38.10	1.500	11.43 0.450	24 <b>2628280000</b>

**Accessories**

**Note:** Refer to the Accessories chapter for additional accessories.

Coding	Order No.
BV/SV 7.62HP K0	<b>1937590000</b>





SV 7.62HP../90MSF3.SC../R



Dimensioned drawing

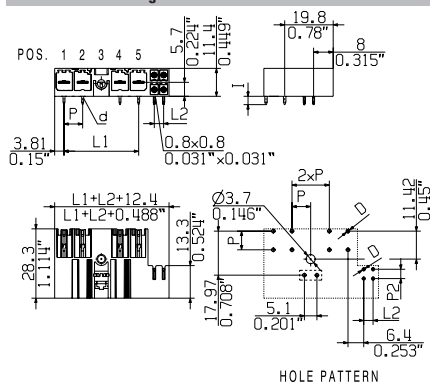

Ordering data

Solder pin length		3.5 mm		
Colour		Black		
Pitch		7.62 mm		
Poles	L1 (inch)	L2 (inch)	Qty.	Order No.
3/4	22.86	0.900	3.81 0.150 48	1089890000
3/6	22.86	0.900	7.62 0.300 42	1089970000
3/8	22.86	0.900	11.43 0.450 36	1156880000
4/4	30.48	1.200	3.81 0.150 36	2628290000
4/6	30.48	1.200	7.62 0.300 36	2628300000
4/8	30.48	1.200	11.43 0.450 30	2628310000
5/4	38.10	1.500	3.81 0.150 30	1157000000
5/6	38.10	1.500	7.62 0.300 30	1157010000
5/8	38.10	1.500	11.43 0.450 30	1157020000

SV 7.62HP../90MSF4.SC../R



Dimensioned drawing

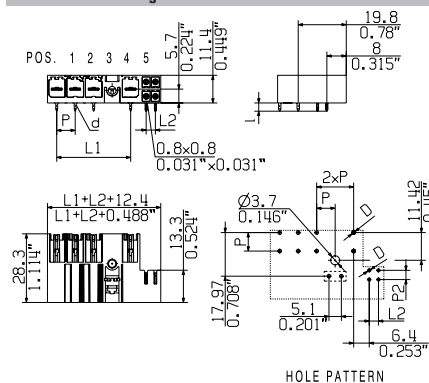

Ordering data

Solder pin length		3.5 mm		
Colour		Black		
Pitch		7.62 mm		
Poles	L1 (inch)	L2 (inch)	Qty.	Order No.
4/4	30.48	1.200	3.81 0.150 36	1090370000
4/6	30.48	1.200	7.62 0.300 36	1090450000
4/8	30.48	1.200	11.43 0.450 30	1156900000
5/4	38.10	1.500	3.81 0.150 30	1090830000
5/6	38.10	1.500	7.62 0.300 30	1090900000
5/8	38.10	1.500	11.43 0.450 30	1157030000



**Connectors in 7.62 mm pitch**  
**Series BV/SV 7.62 - connection up to 6 mm<sup>2</sup>**

**SV 7.62HP../270 & SC 3.81**

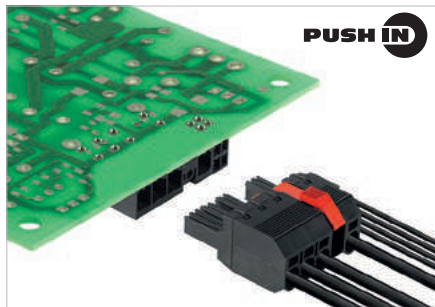

Hybrid male header with 270° outlet direction with power and signal contacts. Meets the enhanced requirements for 3 mm of touch safety for 400 V TNC(S) systems in acc. with IEC 61800-5-1 and comes with UL approval for 600 V in acc. with UL508-5-1 / UL840.

The self-locking middle flange reduces the space requirements by one pitch width compared to conventional solutions.

Variants: middle flange and middle screw flange fastening.

**Product data**

IEC: 1000 V / 41 A  
 UL: 300 V / 35 A



For additional articles and information, refer to [catalog.weidmuller.com](http://catalog.weidmuller.com)

**Note:**

- Technical specifications refer to the power contacts
- Technical data of signal contacts: 50V / 5A, stripping length 8mm
- Rated current related to rated cross-section & min. No. of poles.
- Specifications of diagram: P1=7.62 mm; P2=3.81 mm
- Rated data refer only to the component itself. Clearance and creepage distances to other components are to be designed in accordance with the relevant application standards.

**SV 7.62HP../270 SC../R**



**Dimensioned drawing**

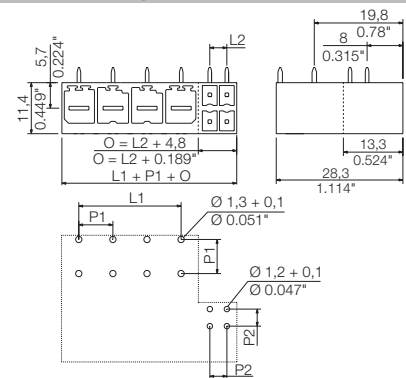

**Technical data**

**In compliance with IEC 60664-1 / IEC 61984**

Clamping range, max.			
<b>Solid core H05(07) V-U</b>			
Stranded H07 V-R			
Flexible H05(07) V-K			
Flexible with ferrule			
Ferrule with plastic collar			
Stripping length			
Screwdriver blade	mm		
According to norm			
Tightening torque range			
<b>Rated current, max.</b>	<b>A</b>	<b>41</b>	<b>41</b>
At ambient temperature		20°C	40°C
For conductor cross-section			
Overtoltage category		III	III II
Pollution severity		3	2 2
<b>Rated voltage</b>	<b>V</b>	<b>630</b>	<b>630 1000</b>
Rated impulse voltage	kV	6	6 6
<b>UL / CUL (Use Group)</b>		<b>B</b>	<b>C D</b>

<b>Rated voltage</b>	<b>V</b>	<b>300</b>	<b>300 600</b>
<b>Rated current</b>	<b>A</b>	<b>35</b>	<b>35 5</b>
<b>AWG conductor</b>	<b>AWG</b>		
<b>CSA (Use Group)</b>		<b>B</b>	<b>C D</b>
Rated voltage	V	300	300 600
Rated current	A	33	33 5
AWG conductor	AWG		

<b>General data</b>			
Type of insulation material		PA GF	
UL 94 flammability rating		V-0	
Contact base material		Copper alloy	
Material of contact surface		tinned	
Pin dimensions = d	mm	0.8 x 1.0	
Solder eyelet Ø = D	mm	1.3	
Solder eyelet Ø tolerance	mm	+ 0,1	

**Accessories**

**Note:** Refer to the Accessories chapter for additional accessories.

Coding		Order No.
	BV/SV 7.62HP KO	1937590000

**Ordering data**

Solder pin length		3.5 mm				
Colour		Black				
Pitch		7.62 mm				
Poles	L1 (inch)	L2 (inch)	Qty.	Order No.		
2 / 4	7.62	0.300	3.81	0.150	78	1090770000
2 / 6	7.62	0.300	7.62	0.300	66	1090850000
2 / 8	7.62	0.300	11.43	0.450	60	1156920000
3 / 4	15.24	0.600	3.81	0.150	60	1090950000
3 / 6	15.24	0.600	7.62	0.300	54	1091010000
3 / 8	15.24	0.600	11.43	0.450	48	1156940000
4 / 4	22.86	0.900	3.81	0.150	48	1091120000
4 / 6	22.86	0.900	7.62	0.300	42	1091160000
4 / 8	22.86	0.900	11.43	0.450	42	1156970000
5 / 4	30.48	1.200	3.81	0.150	36	1091240000
5 / 6	30.48	1.200	7.62	0.300	36	1091260000
5 / 8	30.48	1.200	11.43	0.450	36	1156990000



**Connectors in 7.62 mm pitch**  
**Series BV/SV 7.62 - connection up to 6 mm<sup>2</sup>**

**SV 7.62HP/./270 & SC 3.81MF**

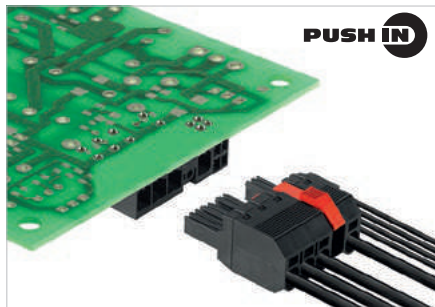

Hybrid male header with 270° outlet direction with power and signal contacts. Meets the enhanced requirements for 3 mm of touch safety for 400 V TNC(S) systems in acc. with IEC 61800-5-1 and comes with UL approval for 600 V in acc. with UL508-5-1 / UL840.

The self-locking middle flange reduces the space requirements by one pitch width compared to conventional solutions.

Variants: middle flange and middle screw flange fastening.

**Product data**

IEC: 1000 V / 41 A  
 UL: 300 V / 35 A



For additional articles and information, refer to [catalog.weidmuller.com](http://catalog.weidmuller.com)

**Note:**

- Technical specifications refer to the power contacts
- Technical data of signal contacts: 50V / 5A, stripping length 8mm
- Rated current related to rated cross-section & min. No. of poles.
- Specifications of diagram: P1=7.62 mm; P2=3.81 mm
- Rated data refer only to the component itself. Clearance and creepage distances to other components are to be designed in accordance with the relevant application standards.
- MFX and MSFX: X= Position of the middle flange e.g. MF2, MSF3

**SV 7.62HP/./270MF2. SC/..R**



**Dimensioned drawing**

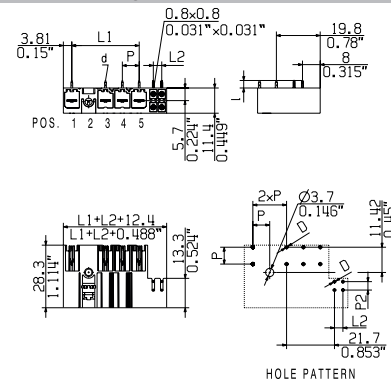

**Technical data**

**In compliance with IEC 60664-1 / IEC 61984**

Clamping range, max.			
<b>Solid core H05(07) V-U</b>			
Stranded H07 V-R			
Flexible H05(07) V-K			
Flexible with ferrule			
Ferrule with plastic collar			
Stripping length			
Screwdriver blade	mm		
According to norm			
Tightening torque range			
<b>Rated current, max.</b>	<b>A</b>	<b>41</b>	<b>41</b>
At ambient temperature		20°C	40°C
For conductor cross-section			
Overtoltage category		III	III II
Pollution severity		3	2 2
<b>Rated voltage</b>	<b>V</b>	<b>630</b>	<b>630 1000</b>
Rated impulse voltage	kV	6	6 6
<b>UL / CUL (Use Group)</b>		<b>B</b>	<b>C D</b>
<b>Rated voltage</b>	<b>V</b>	<b>300</b>	<b>300 600</b>
<b>Rated current</b>	<b>A</b>	<b>35</b>	<b>35 5</b>
<b>AWG conductor</b>	<b>AWG</b>		
<b>CSA (Use Group)</b>		<b>B</b>	<b>C D</b>
Rated voltage	V	300	300 600
Rated current	A	33	33 5
AWG conductor	AWG		
<b>General data</b>			
Type of insulation material		PA GF	
UL 94 flammability rating		V-0	
Contact base material		Copper alloy	
Material of contact surface		tinned	
Pin dimensions = d	mm	0.8 x 1.0	
Solder eyelet Ø = D	mm	1.3	
Solder eyelet Ø tolerance	mm	+ 0,1	

**Accessories**

**Note:** Refer to the Accessories chapter for additional accessories.

Coding	Order No.
BV/SV 7.62HP K0	1937590000



**Ordering data**

Solder pin length		3.5 mm	
Colour		Black	
Pitch 7.62 mm			
Poles	L1 (inch)	L2 (inch)	Qty. Order No.
2 / 4	15.24	0.600 3.81	0.150 60 <b>1089260000</b>
2 / 6	15.24	0.600 7.62	0.300 54 <b>1089280000</b>
2 / 8	15.24	0.600 11.43	0.450 48 <b>1156120000</b>
3 / 4	22.86	0.900 3.81	0.150 48 <b>1156140000</b>
3 / 6	22.86	0.900 7.62	0.300 42 <b>1156150000</b>
3 / 8	22.86	0.900 11.43	0.450 36 <b>1156170000</b>
4 / 4	30.48	1.200 3.81	0.150 36 <b>2627960000</b>
4 / 6	30.48	1.200 7.62	0.300 36 <b>2627970000</b>
4 / 8	30.48	1.200 11.43	0.450 30 <b>2627980000</b>
5 / 4	38.10	1.500 3.81	0.150 30 <b>2627990000</b>
5 / 6	38.10	1.500 7.62	0.300 30 <b>2628000000</b>
5 / 8	38.10	1.500 11.43	0.450 24 <b>2628010000</b>

SV 7.62HP../270MF3.SC/..R



Dimensioned drawing

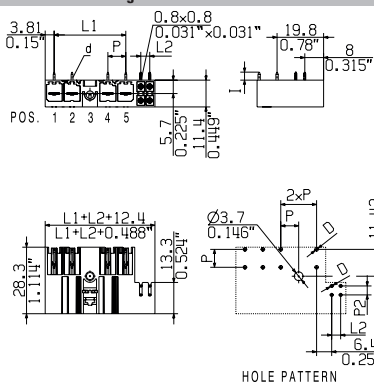

Ordering data

Solder pin length		3.5 mm		
Colour		Black		
Pitch		7.62 mm		
Poles	L1 (inch)	L2 (inch)	Qty.	Order No.
3/4	22.86	0.900	3.81 0.150 48	1089440000
3/6	22.86	0.900	7.62 0.300 42	1089490000
3/8	22.86	0.900	11.43 0.450 36	1156180000
4/4	30.48	1.200	3.81 0.150 36	2628020000
4/6	30.48	1.200	7.62 0.300 36	2628030000
4/8	30.48	1.200	11.43 0.450 30	2628040000
5/4	30.48	1.500	3.81 0.150 30	1156300000
5/6	38.10	1.500	7.62 0.300 30	1156310000
5/8	38.10	1.500	11.43 0.450 30	1156320000

SV 7.62HP../270MF4.SC/..R



Dimensioned drawing

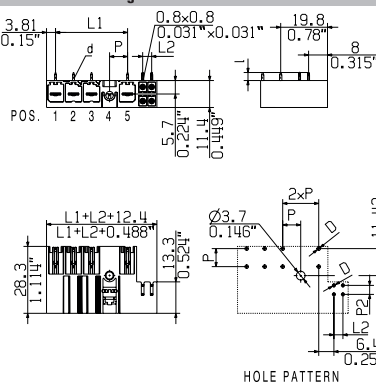

Ordering data

Solder pin length		3.5 mm		
Colour		Black		
Pitch		7.62 mm		
Poles	L1 (inch)	L2 (inch)	Qty.	Order No.
4/4	30.48	0.900	3.81 0.150 36	1089820000
4/6	30.48	1.200	7.62 0.300 36	1089910000
4/8	30.48	1.200	11.43 0.450 30	1156280000
5/4	38.10	1.500	3.81 0.150 30	1090300000
5/6	38.10	1.500	7.62 0.300 30	1090380000
5/8	38.10	1.500	11.43 0.450 30	1156340000

**Connectors in 7.62 mm pitch**  
**Series BV/SV 7.62 - connection up to 6 mm<sup>2</sup>**

**SV 7.62HP../270 & SC 3.81MSF**

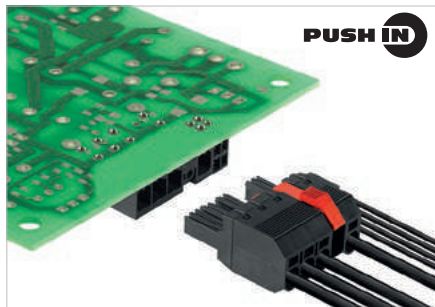

Hybrid male header with 270° outlet direction with power and signal contacts. Meets the enhanced requirements for 3 mm of touch safety for 400 V TNC(S) systems in acc. with IEC 61800-5-1 and comes with UL approval for 600 V in acc. with UL508-5-1 / UL840.

The self-locking middle flange reduces the space requirements by one pitch width compared to conventional solutions.

Variants: middle flange and middle screw flange fastening.

**Product data**

IEC: 1000 V / 41 A  
 UL: 300 V / 35 A



For additional articles and information, refer to [catalog.weidmuller.com](http://catalog.weidmuller.com)

**Note:**

- Technical specifications refer to the power contacts
- Technical data of signal contacts: 50V / 5A, stripping length 8mm
- Rated current related to rated cross-section & min. No. of poles.
- Specifications of diagram: P1=7.62 mm; P2=3.81 mm
- Rated data refer only to the component itself. Clearance and creepage distances to other components are to be designed in accordance with the relevant application standards.
- MFX and MSFX: X= Position of the middle flange e.g. MF2, MSF3

**SV 7.62HP../270MSF2, SC../R**



**Dimensioned drawing**

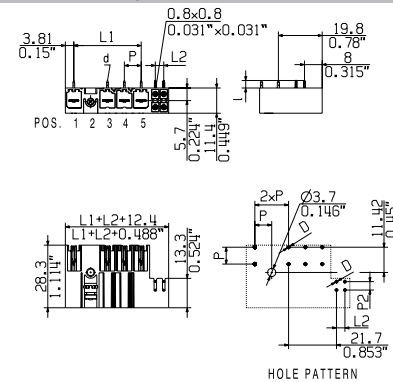

**Technical data**

**In compliance with IEC 60664-1 / IEC 61984**

Clamping range, max.			
<b>Solid core H05(07) V-U</b>			
Stranded H07 V-R			
Flexible H05(07) V-K			
Flexible with ferrule			
Ferrule with plastic collar			
Stripping length			
Screwdriver blade		mm	
According to norm			
Tightening torque range			
<b>Rated current, max.</b>	<b>A</b>	<b>41</b>	<b>41</b>
At ambient temperature		20°C	40°C
For conductor cross-section			
Overtoltage category		III	III II
Pollution severity		3	2 2
<b>Rated voltage</b>	<b>V</b>	<b>630</b>	<b>630 1000</b>
Rated impulse voltage	kV	6	6 6
<b>UL / CUL (Use Group)</b>		<b>B</b>	<b>C D</b>
<b>Rated voltage</b>	<b>V</b>	<b>300</b>	<b>300 600</b>
<b>Rated current</b>	<b>A</b>	<b>35</b>	<b>35 5</b>
<b>AWG conductor</b>	<b>AWG</b>		
<b>CSA (Use Group)</b>		<b>B</b>	<b>C D</b>
Rated voltage	V	300	300 600
Rated current	A	33	33 5
AWG conductor	AWG		
<b>General data</b>			
Type of insulation material		PA GF	
UL 94 flammability rating		V-0	
Contact base material		Copper alloy	
Material of contact surface		tinned	
Pin dimensions = d	mm	0.8 x 1.0	
Solder eyelet Ø = D	mm	1.3	
Solder eyelet Ø tolerance	mm	+ 0,1	

**Accessories**

**Note:** Refer to the Accessories chapter for additional accessories.

Coding	Order No.
BV/SV 7.62HP K0	1937590000



**Ordering data**

<b>Solder pin length</b>	3.5 mm					
<b>Colour</b>	Black					
<b>Pitch</b>	7.62 mm					
Poles	L1 (inch)	L2 (inch)	Qty.	Order No.		
2 / 4	15.24	0.600	3.81	0.150	60	1089340000
2 / 6	15.24	0.600	7.62	0.300	54	1089380000
2 / 8	15.24	0.600	11.43	0.450	48	1156130000
3 / 4	22.86	0.900	3.81	0.150	48	1156190000
3 / 6	22.86	0.900	7.62	0.300	42	1156200000
3 / 8	22.86	0.900	11.43	0.450	36	1156210000
4 / 4	30.48	1.200	3.81	0.150	36	2628050000
4 / 6	30.48	1.200	7.62	0.300	36	2628060000
4 / 8	30.48	1.200	11.43	0.450	30	2628070000
5 / 4	38.10	1.500	3.81	0.150	30	2628080000
5 / 6	38.10	1.500	7.62	0.300	30	2628090000
5 / 8	38.10	1.500	11.43	0.450	24	2628100000

SV 7.62HP../270MSF3. SC/..R



Dimensioned drawing

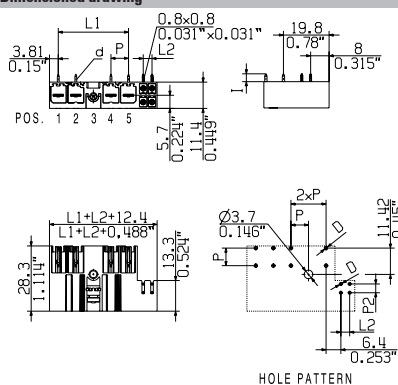

Ordering data

Solder pin length		3.5 mm		
Colour		Black		
Pitch		7.62 mm		
Poles	L1 (inch)	L2 (inch)	Qty.	Order No.
3/4	22.86	0.900	3.81 0.150 48	1089610000
3/6	22.86	0.900	7.62 0.300 42	1089670000
3/8	22.86	0.900	11.43 0.450 36	1156220000
4/4	30.48	1.200	3.81 0.150 36	2628110000
4/6	30.48	1.200	7.62 0.300 36	2628120000
4/8	30.48	1.200	11.43 0.450 30	2628130000
5/4	38.10	1.500	3.81 0.150 30	1156370000
5/6	38.10	1.500	7.62 0.300 30	1156390000
5/8	38.10	1.500	11.43 0.450 30	1156410000

SV 7.62HP../270MSF4. SC/..R



Dimensioned drawing

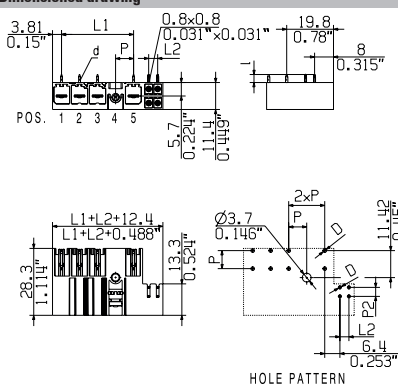

Ordering data

Solder pin length		3.5 mm		
Colour		Black		
Pitch		7.62 mm		
Poles	L1 (inch)	L2 (inch)	Qty.	Order No.
4/4	30.48	1.200	3.81 0.150 36	1090060000
4/6	30.48	1.200	7.62 0.300 36	1090140000
4/8	30.48	1.200	11.43 0.450 30	1156290000
5/4	38.10	1.500	3.81 0.150 30	1090540000
5/6	38.10	1.500	7.62 0.300 30	1090610000
5/8	38.10	1.500	11.43 0.450 30	1156430000

**Connectors in 7.62 mm pitch**  
**Series BV/SV 7.62 - connection up to 6 mm<sup>2</sup>**

**BVF 7.62HP../180 & BCF 3.81**

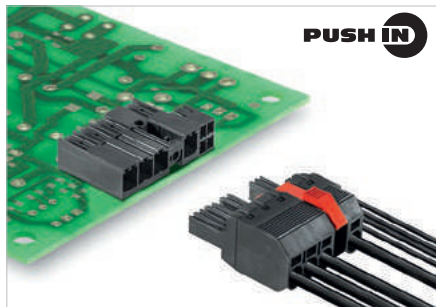

**PUSH IN**

Hybrid female plug with power and signal contacts with PUSH IN connection system. Allows power, signals and shield to be plugged in simultaneously. It is perfect for connecting servo-drives and asynchronous drives. Meets the requirements of UL1059 for 600 V Use Group C. The mating profile ensures touch-safety of > 3 mm in accordance with IEC 61800-5-1. The pluggable shield connection establishes a large contact area on the device housing and does not need to be screwed on separately.

**Technical data**

In compliance with IEC 60664-1 / IEC 61984			
Clamping range, max.	mm <sup>2</sup>	0.5...10	
<b>Solid core H05(07) V-U</b>	<b>mm<sup>2</sup></b>	<b>0.5...10</b>	
Stranded H07 V-R			
Flexible H05(07) V-K	mm <sup>2</sup>	0.5...6	
Flexible with ferrule	mm <sup>2</sup>	0.5...10	
Ferrule with plastic collar	mm <sup>2</sup>	0.5...6	
Stripping length	mm	12	
Screwdriver blade	mm	0.6 x 3.5	
According to norm			
Tightening torque range			
<b>Rated current, max.</b>	<b>A</b>	<b>38</b>	<b>34</b>
At ambient temperature		20°C	40°C
For conductor cross-section	mm <sup>2</sup>	6	
Overvoltage category		III	III II
Pollution severity		3	2 2
<b>Rated voltage</b>	<b>V</b>	<b>800</b>	<b>1000 1000</b>
Rated impulse voltage	kV	8	8 6
<b>UL / CUL (Use Group)</b>		<b>B</b>	<b>C D</b>
<b>Rated voltage</b>	<b>V</b>	<b>600</b>	<b>600 600</b>
<b>Rated current</b>	<b>A</b>	<b>35</b>	<b>35 5</b>
<b>AWG conductor</b>	<b>AWG</b>	<b>24-8</b>	
<b>CSA (Use Group)</b>		<b>B</b>	<b>C D</b>
Rated voltage	V	600	600 600
Rated current	A	33	33 5
AWG conductor	AWG	24-8	
General data			
Type of insulation material		PA GF	
UL 94 flammability rating		V-0	
Contact base material		Copper alloy	
Material of contact surface		tinned	
Pin dimensions = d	mm		
Solder eyelet Ø = D	mm		
Solder eyelet Ø tolerance	mm		

**Product data**

IEC: 1000 V / 38 A / 0.5 - 10 mm<sup>2</sup>  
 UL: 600 V / 35 A / AWG 24 - 8



For additional articles and information, refer to [catalog.weidmuller.com](http://catalog.weidmuller.com)

**Note:**

- Technical specifications refer to the power contacts
- Technical data of signal contacts: 50V / 5A, stripping length 8mm
- Additional colours on request
- Rated current related to rated cross-section & min. No. of poles.
- Wire end ferrule with plastic collar to DIN 46228/4
- Wire end ferrule without plastic collar to DIN 46228/1
- Rated data refer only to the component itself. Clearance and creepage distances to other components are to be designed in accordance with the relevant application standards.

**BVF 7.62HP../180 BCF../R**



**Dimensioned drawing**

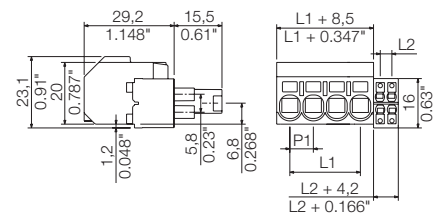

**Accessories**

**Note:** Refer to the Accessories chapter for additional accessories.

Coding	Order No.
BV/SV 7.62HP K0	1937590000
<b>Screwdriver</b>	
SDS 0.8X4.5X125	9009020000
<b>Crimping tool</b>	
PZ 6/5	9011460000

**Ordering data**

Solder pin length						
Colour						Black
Pitch 7.62 mm						
Poles	L1 (inch)	L2 (inch)	Qty.	Order No.		
2 / 4	7.62	0.300	3.81	0.150	65	1080550000
2 / 6	7.62	0.300	7.62	0.300	55	1080320000
2 / 8	7.62	0.300	11.43	0.450	50	1156440000
3 / 4	15.24	0.600	3.81	0.150	50	1080490000
3 / 6	15.24	0.600	7.62	0.300	45	1080570000
3 / 8	15.24	0.600	11.43	0.450	40	1156450000
4 / 4	22.86	0.900	3.81	0.150	40	1080510000
4 / 6	22.86	0.900	7.62	0.300	35	1080440000
4 / 8	22.86	0.900	11.43	0.450	30	1156470000
5 / 8	30.48	1.200	11.43	0.450	25	1156480000

**Representative deratings curve**

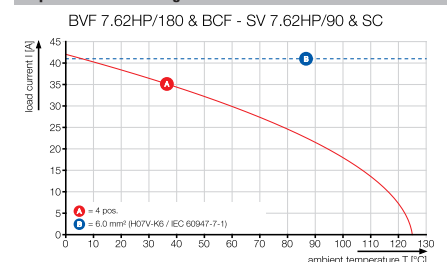





**Connectors in 7.62 mm pitch**  
**Series BV/SV 7.62 - connection up to 6 mm<sup>2</sup>**

**BVF 7.62HP../180MF & BCF 3.81**

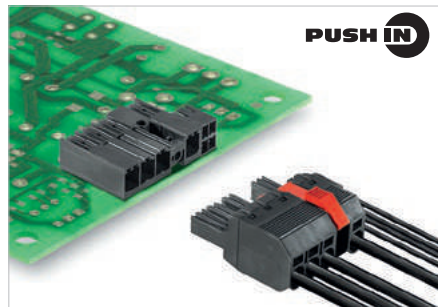

Hybrid female plug with power and signal contacts with PUSH IN connection system. Allows power, signals and shield to be plugged in simultaneously. It is perfect for connecting servo-drives and asynchronous drives. Meets the requirements of UL1059 for 600 V Use Group C. The mating profile ensures touch-safety of > 3 mm in accordance with IEC 61800-5-1. The self-fastening middle flange reduces the space requirements by one pole.

The pluggable shield connection establishes a large contact area on the device housing and does not need to be screwed on separately.

**Product data**

IEC: 1000 V / 38 A / 0.5 - 10 mm<sup>2</sup>  
 UL: 600 V / 35 A / AWG 24 - 8



For additional articles and information, refer to [catalog.weidmuller.com](http://catalog.weidmuller.com)

**Note:**

- Technical specifications refer to the power contacts
- Technical data of signal contacts: 50V / 5A, stripping length 8mm
- Additional colours on request
- Rated current related to rated cross-section & min. No. of poles.
- Wire end ferrule with plastic collar to DIN 46228/4
- Wire end ferrule without plastic collar to DIN 46228/1
- Rated data refer only to the component itself. Clearance and creepage distances to other components are to be designed in accordance with the relevant application standards.
- MFX and MSFX: X= Position of the middle flange e.g. MF2, MSF3

**BVF 7.62HP../180MF2, BCF../R**



**Dimensioned drawing**

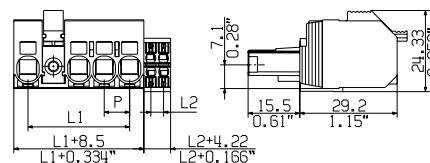

**Technical data**

**In compliance with IEC 60664-1 / IEC 61984**

Clamping range, max.	mm <sup>2</sup>	0.5...10
<b>Solid core H05(07) V-U</b>	<b>mm<sup>2</sup></b>	<b>0.5...10</b>
Stranded H07 V-R		
Flexible H05(07) V-K	mm <sup>2</sup>	0.5...6
Flexible with ferrule	mm <sup>2</sup>	0.5...10
Ferrule with plastic collar	mm <sup>2</sup>	0.5...6
Stripping length	mm	12
Screwdriver blade	mm	0.6 x 3.5

According to norm

Tightening torque range  
**Rated current, max.**      **A**    **38**      **34**  
 At ambient temperature      20°C      40°C

For conductor cross-section      mm<sup>2</sup>      6

Overvoltage category      III      III      II

Pollution severity      3      2      2

**Rated voltage**      **V**      **800**      **1000**      **1000**

Rated impulse voltage      kV      8      8      6

**UL / CUL (Use Group)**      **B**      **C**      **D**

**Rated voltage**      **V**      **600**      **600**      **600**

**Rated current**      **A**      **35**      **35**      **5**

**AWG conductor**      **AWG**      **24-8**

**CSA (Use Group)**      **B**      **C**      **D**

Rated voltage      V      600      600      600

Rated current      A      33      33      5

AWG conductor      AWG      24-8

**General data**

Type of insulation material      PA GF

UL 94 flammability rating      V-0

Contact base material      Copper alloy

Material of contact surface      tinned

Pin dimensions = d      mm

Solder eyelet Ø = D      mm

**Accessories**

**Note:** Refer to the Accessories chapter for additional accessories.

Coding	Order No.
BV/SV 7.62HP K0	1937590000
<b>Shielding</b>	
BVF 7.62HP SH150 4-6 KIT	1118480000
BVF 7.62HP SH180 4-6 KIT	1118470000
BVF 7.62HP SH210 4-6 KIT	1118490000
<b>Screwdriver</b>	
SDS 0.8X4.5X125	9009020000
<b>Crimping tool</b>	
PZ 6/5	9011460000

**Ordering data**

**Solder pin length**

Colour	Black					
Pitch	7.62 mm					
Poles	L1 (inch)	L2 (inch)	Qty.	Order No.		
2 / 4	15.24	0.600	3.81	0.150	50	1081610000
2 / 6	15.24	0.600	7.62	0.300	45	1081030000
2 / 8	15.24	0.600	11.43	0.450	40	1157090000
3 / 4	22.86	0.900	3.81	0.150	40	1157110000
3 / 6	22.86	0.900	7.62	0.300	35	1157120000
3 / 8	22.86	0.900	11.43	0.450	30	1157130000
4 / 4	30.48	1.200	3.81	0.150	36	2628320000
4 / 6	30.48	1.200	7.62	0.300	36	2628340000
4 / 8	30.48	1.200	11.43	0.450	30	2628350000
5 / 4	38.10	1.500	3.81	0.150	30	2628390000
5 / 6	38.10	1.500	7.62	0.300	30	2628400000
5 / 8	38.10	1.500	11.43	0.450	24	2628410000

**Representative deratings curve**

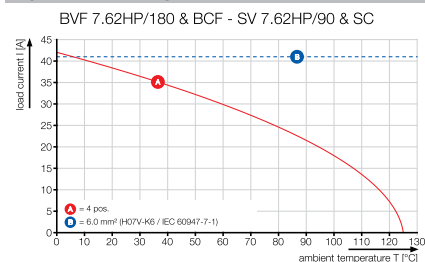

**BVF 7.62HP../180MF3. BCF../R**



Dimensioned drawing

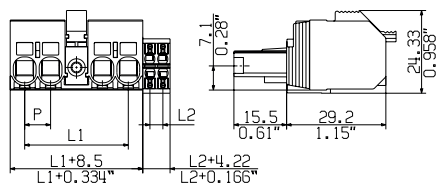

**BVF 7.62HP../180MF4. BCF../R**



Dimensioned drawing

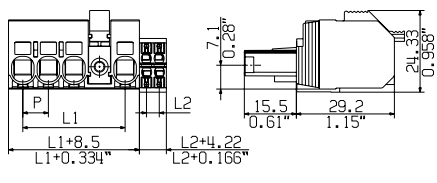

**Ordering data**

Solder pin length						
Colour						Black
Pitch 7.62 mm						
Poles	L1	(inch)	L2	(inch)	Qty.	Order No.
3/4	22.86	0.900	3.81	0.150	40	1081630000
3/6	22.86	0.900	7.62	0.300	35	1081720000
3/8	22.86	0.900	11.43	0.450	30	1157170000
4/4	30.48	1.200	3.81	0.150	36	2628450000
4/6	30.48	1.200	7.62	0.300	36	2628460000
4/8	30.48	1.200	11.43	0.450	30	2628470000
5/4	38.10	1.500	3.81	0.150	25	1157220000
5/6	38.10	1.500	7.62	0.300	25	1157230000
5/8	38.10	1.500	11.43	0.450	25	1157240000

**Ordering data**

Solder pin length						
Colour						Black
Pitch 7.62 mm						
Poles	L1	(inch)	L2	(inch)	Qty.	Order No.
4/4	30.48	1.200	3.81	0.150	30	1081150000
4/6	30.48	1.200	7.62	0.300	30	1082020000
4/8	30.48	1.200	11.43	0.450	25	1157200000
5/4	38.10	1.500	3.81	0.150	25	1082140000
5/6	38.10	1.500	7.62	0.300	25	1081760000
5/8	38.10	1.500	11.43	0.450	25	1157250000

**Connectors in 7.62 mm pitch**  
**Series BV/SV 7.62 - connection up to 6 mm<sup>2</sup>**

**BVF 7.62HP../180MSF & BCF 3.81**

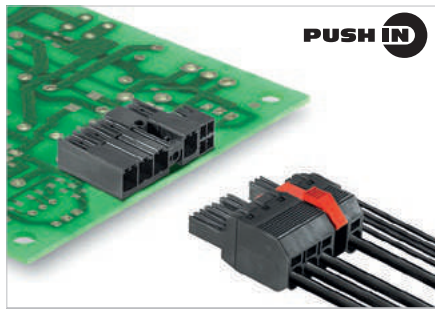

**PUSH IN**

Hybrid female plug with power and signal contacts with PUSH IN connection system. Allows power, signals and shield to be plugged in simultaneously. It is perfect for connecting servo-drives and asynchronous drives. Meets the requirements of UL1059 for 600 V Use Group C. The mating profile ensures touch-safety of > 3 mm in accordance with IEC 61800-5-1. The self-fastening middle flange reduces the space requirements by one pole.

The pluggable shield connection establishes a large contact area on the device housing and does not need to be screwed on separately.

**Technical data**

In compliance with IEC 60664-1 / IEC 61984			
Clamping range, max.	mm <sup>2</sup>	0.5...10	
<b>Solid core H05(07) V-U</b>	<b>mm<sup>2</sup></b>	<b>0.5...10</b>	
Stranded H07 V-R			
Flexible H05(07) V-K	mm <sup>2</sup>	0.5...6	
Flexible with ferrule	mm <sup>2</sup>	0.5...10	
Ferrule with plastic collar	mm <sup>2</sup>	0.5...6	
Stripping length	mm	12	
Screwdriver blade	mm	0.6 x 3.5	
According to norm			
Tightening torque range			
<b>Rated current, max.</b>	<b>A</b>	<b>38</b>	<b>34</b>
At ambient temperature		20°C	40°C
For conductor cross-section	mm <sup>2</sup>	6	
Overvoltage category		III	III II
Pollution severity		3	2 2
<b>Rated voltage</b>	<b>V</b>	<b>800</b>	<b>1000 1000</b>
Rated impulse voltage	kV	8	8 6
<b>UL / CUL (Use Group)</b>		<b>B</b>	<b>C D</b>
<b>Rated voltage</b>	<b>V</b>	<b>600</b>	<b>600 600</b>
<b>Rated current</b>	<b>A</b>	<b>35</b>	<b>35 5</b>
<b>AWG conductor</b>	<b>AWG</b>		<b>24-8</b>
<b>CSA (Use Group)</b>		<b>B</b>	<b>C D</b>
Rated voltage	V	600	600 600
Rated current	A	33	33 5
AWG conductor	AWG		24-8
<b>General data</b>			
Type of insulation material		PA GF	
UL 94 flammability rating		V-0	
Contact base material		Copper alloy	
Material of contact surface		tinned	
Pin dimensions = d	mm		
Solder eyelet Ø = D	mm		
Solder eyelet Ø tolerance	mm		

**Product data**

IEC: 1000 V / 38 A / 0.5 - 10 mm<sup>2</sup>  
 UL: 600 V / 35 A / AWG 24 - 8



For additional articles and information, refer to [catalog.weidmuller.com](http://catalog.weidmuller.com)

**Note:**

- Technical specifications refer to the power contacts
- Technical data of signal contacts: 50V / 5A, stripping length 8mm
- Additional colours on request
- Rated current related to rated cross-section & min. No. of poles.
- Wire end ferrule with plastic collar to DIN 46228/4
- Wire end ferrule without plastic collar to DIN 46228/1
- Rated data refer only to the component itself. Clearance and creepage distances to other components are to be designed in accordance with the relevant application standards.
- MFX and MSFX: X= Position of the middle flange e.g. MF2, MSF3

**BVF 7.62HP../180MSF2. BCF../R**



**Dimensioned drawing**

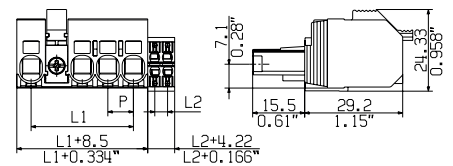

**Accessories**

**Note:** Refer to the Accessories chapter for additional accessories.

Coding	Order No.
BV/SV 7.62HP K0	1937590000
<b>Shielding</b>	
BVF 7.62HP SH150 4-6 KIT	1118480000
BVF 7.62HP SH180 4-6 KIT	1118470000
BVF 7.62HP SH210 4-6 KIT	1118490000
<b>Screwdriver</b>	
SDS 0.8x4.5x125	9009020000
<b>Crimping tool</b>	
PZ 6/5	9011460000

**Ordering data**

Solder pin length						
Colour					Black	
Pitch 7.62 mm						
Poles	L1 (inch)	L2 (inch)	Qty.	Order No.		
2 / 4	15.24	0.600	3.81	0.150	50	1081930000
2 / 6	15.24	0.600	7.62	0.300	45	1082080000
2 / 8	15.24	0.600	11.43	0.450	40	1157100000
3 / 4	22.86	0.900	3.81	0.150	40	1157440000
3 / 6	22.86	0.900	7.62	0.300	35	1157450000
3 / 8	22.86	0.900	11.43	0.450	30	1157470000
4 / 4	30.48	1.200	3.81	0.150	36	2628510000
4 / 6	30.48	1.200	7.62	0.300	36	2628520000
4 / 8	30.48	1.200	11.43	0.450	30	2628530000
5 / 4	38.10	1.500	3.81	0.150	30	2628570000
5 / 6	38.10	1.500	7.62	0.300	30	2628580000
5 / 8	38.10	1.500	11.43	0.450	24	2628590000

**Representative deratings curve**

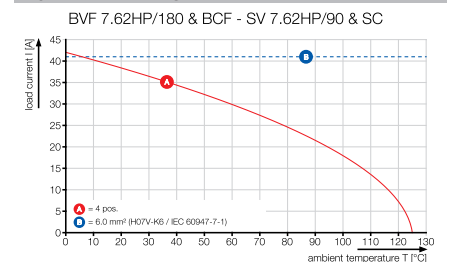

**BVF 7.62HP../180MSF3. BCF../R**



Dimensioned drawing

**BVF 7.62HP../180MSF4. BCF../R**



Dimensioned drawing

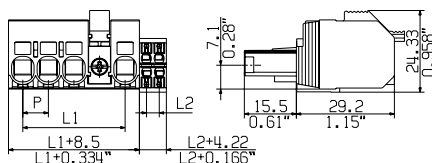
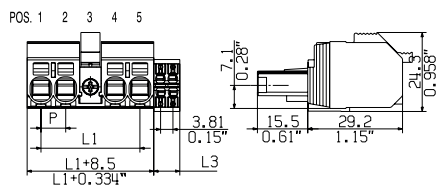

**Ordering data**

Solder pin length						
Colour						Black
Pitch 7.62 mm						
Poles	L1 (inch)	L2 (inch)	Qty.	Order No.		
3/4	22.86	0.900	3.81	0.150	40	<b>1082110000</b>
3/6	22.86	0.900	7.62	0.300	35	<b>1081730000</b>
3/8	22.86	0.900	11.43	0.450	30	<b>1157190000</b>
4/4	30.48	1.200	3.81	0.150	36	<b>2628630000</b>
4/6	30.48	1.200	7.62	0.300	36	<b>2628640000</b>
4/8	30.48	1.200	11.43	0.450	30	<b>2628650000</b>
5/4	38.10	1.500	3.81	0.150	25	<b>1157270000</b>
5/6	38.10	1.500	7.62	0.300	25	<b>1157280000</b>
5/8	38.10	1.500	11.43	0.450	25	<b>1157290000</b>

**Ordering data**

Solder pin length						
Colour						Black
Pitch 7.62 mm						
Poles	L1 (inch)	L2 (inch)	Qty.	Order No.		
4/4	30.48	1.200	3.81	0.150	30	<b>1081660000</b>
4/6	30.48	1.200	7.62	0.300	30	<b>1081750000</b>
4/8	30.48	1.200	11.43	0.450	25	<b>1157210000</b>
5/4	38.10	1.500	3.81	0.150	25	<b>1080940000</b>
5/6	38.10	1.500	7.62	0.300	25	<b>1080720000</b>
5/8	38.10	1.500	11.43	0.450	25	<b>1157300000</b>

**Connectors in 7.62 mm pitch**  
**Series BV/SV 7.62 - connection up to 6 mm<sup>2</sup>**

**BVFL 7.62HP../180 BCF 3.81**

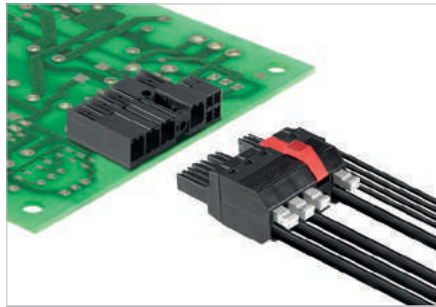

Hybrid female connector with power and signal contacts and adjustable actuator (pusher) featuring PUSH IN spring connection technology. Enables simultaneous connection of power, signals and shielding. Ideal for connecting servo and asynchronous drives. Meets the requirements of UL1059 for 600 V Use Group C. The pin arrangement guarantees more than 3 mm of touch-safety in accordance with IEC 61800-5-1. The snap-on middle flange decreases the space required by one pitch width.

The pluggable shield connection has a wide contact area on the device housing and does not need to be bolted.

**Technical data**

In compliance with IEC 60664-1 / IEC 61984			
Clamping range, max.	mm <sup>2</sup>	0.5...6	
<b>Solid core H05(07) V-U</b>	<b>mm<sup>2</sup></b>	<b>0.5...6</b>	
Stranded H07 V-R			
Flexible H05(07) V-K	mm <sup>2</sup>	0.5...6	
Flexible with ferrule	mm <sup>2</sup>	0.5...6	
Ferrule with plastic collar	mm <sup>2</sup>	0.5...6	
Stripping length	mm	12	
Screwdriver blade	mm	0.6 x 3.5	
According to norm			
Tightening torque range			
<b>Rated current, max.</b>	<b>A</b>	<b>38</b>	<b>34</b>
At ambient temperature		20°C	40°C
For conductor cross-section	mm <sup>2</sup>	6	
Overvoltage category		III	III II
Pollution severity		3	2 2
<b>Rated voltage</b>	<b>V</b>	<b>800</b>	<b>1000 1000</b>
Rated impulse voltage	kV	8	8 6
<b>UL / CUL (Use Group)</b>		<b>B</b>	<b>C D</b>
<b>Rated voltage</b>	<b>V</b>	<b>600</b>	<b>600 600</b>
<b>Rated current</b>	<b>A</b>	<b>35</b>	<b>35 5</b>
<b>AWG conductor</b>	<b>AWG</b>		<b>24-8</b>
<b>CSA (Use Group)</b>		<b>B</b>	<b>C D</b>
Rated voltage	V	600	600 600
Rated current	A	33	33 5
AWG conductor	AWG		24-8
<b>General data</b>			
Type of insulation material		PA GF	
UL 94 flammability rating		V-0	
Contact base material		Copper alloy	
Material of contact surface		tinned	
Pin dimensions = d	mm		
Solder eyelet Ø = D	mm		
Solder eyelet Ø tolerance	mm		

**Product data**

IEC: 1000 V / 38 A / 0.5 - 6 mm<sup>2</sup>  
 UL: 600 V / 35 A / AWG 24 - 8



For additional articles and information, refer to [catalog.weidmuller.com](http://catalog.weidmuller.com)

**Note:**

- Technical specifications refer to the power contacts
- Technical data of signal contacts: 50V / 5A, stripping length 8mm
- Additional colours on request
- Rated current related to rated cross-section & min. No. of poles.
- Wire end ferrule with plastic collar to DIN 46228/4
- Wire end ferrule without plastic collar to DIN 46228/1
- Rated data refer only to the component itself. Clearance and creepage distances to other components are to be designed in accordance with the relevant application standards.
- Additional pole combinations on request

**BVFL 7.62HP../180 BCF 3.81**



**Dimensioned drawing**

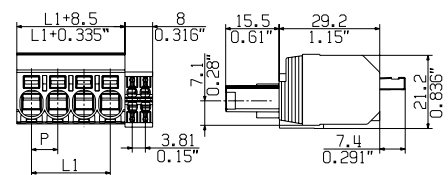

**Accessories**

**Note:** Refer to the Accessories chapter for additional accessories.

Coding	Order No.
BV/SV 7.62HP K0	1937590000
<b>Shielding</b>	
BVF 7.62HP SH150 4-6 KIT	1118480000
BVF 7.62HP SH180 4-6 KIT	1118470000
BVF 7.62HP SH210 4-6 KIT	1118490000
<b>Screwdriver</b>	
SDS 0.8X4.5X125	9009020000
<b>Crimping tool</b>	
PZ 6/5	9011460000

**Ordering data**

Solder pin length						
Colour					Black	
Pitch 7.62 mm						
Poles	L1 (inch)	L2 (inch)	Qty.	Order No.		
2 / 4	7.62	0.300	3.81	0.150	78	2549310000
3 / 4	15.24	0.600	3.81	0.150	45	2549400000
3 / 6	15.24	0.600	7.62	0.300	40	2549410000
3 / 8	15.24	0.600	11.43	0.450	35	2549420000
4 / 4	22.86	0.900	3.81	0.150	48	1547560000
4 / 6	30.48	1.200	7.62	0.300	35	2549430000
4 / 8	30.48	1.200	11.43	0.450	30	2549440000
5 / 4	30.48	1.200	3.81	0.150	30	2549450000

**Representative deratings curve**

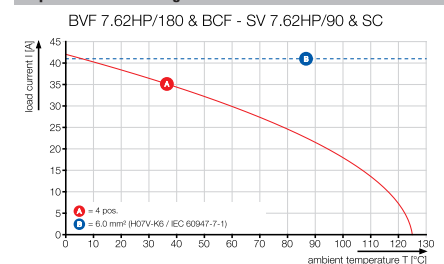



**Connectors in 7.62 mm pitch**  
**Series BV/SV 7.62 - connection up to 6 mm<sup>2</sup>**

**BVFL 7.62HP../180 BCF 3.81**

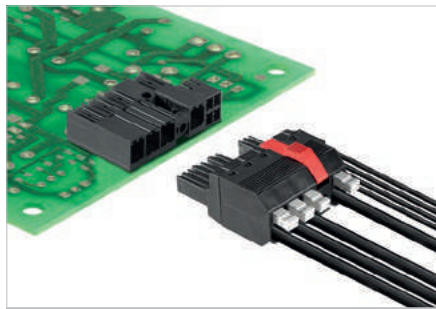

Hybrid female connector with power and signal contacts and adjustable actuator (pusher) featuring PUSH IN spring connection technology. Enables simultaneous connection of power, signals and shielding. Ideal for connecting servo and asynchronous drives. Meets the requirements of UL1059 for 600 V Use Group C. The pin arrangement guarantees more than 3 mm of touch-safety in accordance with IEC 61800-5-1. The snap-on middle flange decreases the space required by one pitch width.

The pluggable shield connection has a wide contact area on the device housing and does not need to be bolted.

**Technical data**

In compliance with IEC 60664-1 / IEC 61984			
Clamping range, max.	mm <sup>2</sup>	0.5...6	
<b>Solid core H05(07) V-U</b>	<b>mm<sup>2</sup></b>	<b>0.5...6</b>	
Stranded H07 V-R			
Flexible H05(07) V-K	mm <sup>2</sup>	0.5...6	
Flexible with ferrule	mm <sup>2</sup>	0.5...6	
Ferrule with plastic collar	mm <sup>2</sup>	0.5...6	
Stripping length	mm	12	
Screwdriver blade	mm	0.6 x 3.5	
According to norm			
Tightening torque range			
<b>Rated current, max.</b>	<b>A</b>	<b>38</b>	<b>34</b>
At ambient temperature		20°C	40°C
For conductor cross-section	mm <sup>2</sup>	6	
Overvoltage category		III	III II
Pollution severity		3	2 2
<b>Rated voltage</b>	<b>V</b>	<b>800</b>	<b>1000 1000</b>
Rated impulse voltage	kV	8	8 6
<b>UL / CUL (Use Group)</b>		<b>B</b>	<b>C D</b>
<b>Rated voltage</b>	<b>V</b>	<b>600</b>	<b>600 600</b>
<b>Rated current</b>	<b>A</b>	<b>35</b>	<b>35 5</b>
<b>AWG conductor</b>	<b>AWG</b>	<b>24-8</b>	
<b>CSA (Use Group)</b>		<b>B</b>	<b>C D</b>
Rated voltage	V	600	600 600
Rated current	A	33	33 5
AWG conductor	AWG	24-8	
<b>General data</b>			
Type of insulation material		PA GF	
UL 94 flammability rating		V-0	
Contact base material		Copper alloy	
Material of contact surface		tinned	
Pin dimensions = d	mm		
Solder eyelet Ø = D	mm		
Solder eyelet Ø tolerance	mm		

**Product data**

IEC: 1000 V / 38 A / 0.5 - 6 mm<sup>2</sup>  
 UL: 600 V / 35 A / AWG 24 - 8



For additional articles and information, refer to [catalog.weidmuller.com](http://catalog.weidmuller.com)

**Note:**

- Technical specifications refer to the power contacts
- Technical data of signal contacts: 50V / 5A, stripping length 8mm
- Additional colours on request
- Rated current related to rated cross-section & min. No. of poles.
- Wire end ferrule with plastic collar to DIN 46228/4
- Wire end ferrule without plastic collar to DIN 46228/1
- Rated data refer only to the component itself. Clearance and creepage distances to other components are to be designed in accordance with the relevant application standards.
- Additional pole combinations on request
- MFX and MSFX: X= Position of the middle flange e.g. MF2, MSF3

**BVFL 7.62HP../180 BCF 3.81 MF SO**



**Dimensioned drawing**

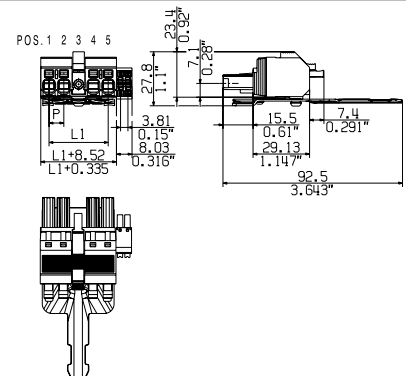

**Ordering data**

Solder pin length						
Colour						Black
Pitch		7.62 mm				
Poles	L1 (inch)	L2 (inch)	Qty.	Order No.		
4 / 4	30.48	1.200	3.81	0.150	20	2427960000

**Accessories**

**Note:** Refer to the Accessories chapter for additional accessories.

Coding	Order No.
BV/SV 7.62HP K0	1937590000
<b>Crimping tool</b>	
PZ 6/5	9011460000
<b>Screwdriver</b>	
SDS 0.6X3.5X100	9008330000
SCT 4_6/127 C	1699800000
WSM TOOL AUTOMATIK	1774470000

**Representative deratings curve**

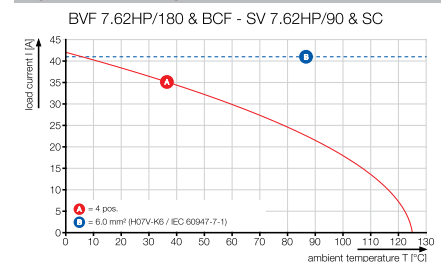



Dimensioned drawing

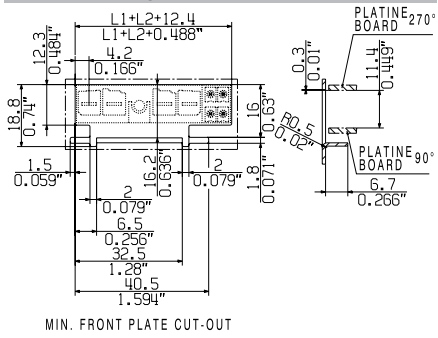

**Connectors in 7.62 mm pitch**  
**Series BV/SV 7.62 - connection up to 6 mm<sup>2</sup>**

**BVFL 7.62HP/./180 BCF 3.81 MF**

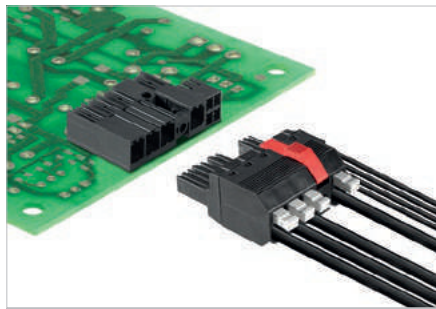

Hybrid female connector with power and signal contacts and adjustable actuator (pusher) featuring PUSH IN spring connection technology. Enables simultaneous connection of power, signals and shielding. Ideal for connecting servo and asynchronous drives. Meets the requirements of UL1059 for 600 V Use Group C. The pin arrangement guarantees more than 3 mm of touch-safety in accordance with IEC 61800-5-1. The snap-on middle flange decreases the space required by one pitch width.

The pluggable shield connection has a wide contact area on the device housing and does not need to be bolted.

**Product data**

IEC: 1000 V / 38 A / 0.5 - 6 mm<sup>2</sup>  
 UL: 600 V / 35 A / AWG 24 - 8



For additional articles and information, refer to [catalog.weidmueller.com](http://catalog.weidmueller.com)

**Note:**

- Technical specifications refer to the power contacts
- Technical data of signal contacts: 50V / 5A, stripping length 8mm
- Additional colours on request
- Rated current related to rated cross-section & min. No. of poles.
- Wire end ferrule with plastic collar to DIN 46228/4
- Wire end ferrule without plastic collar to DIN 46228/1
- Rated data refer only to the component itself. Clearance and creepage distances to other components are to be designed in accordance with the relevant application standards.
- Additional pole combinations on request
- MF2 and MSFX: X= Position of the middle flange e.g. MF2, MSFX3

**BVFL 7.62HP/./180 BCF 3.81 MF2**



**Dimensioned drawing**

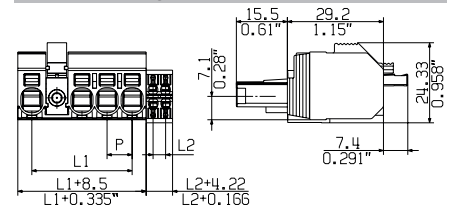

**Technical data**

In compliance with IEC 60664-1 / IEC 61984			
Clamping range, max.	mm <sup>2</sup>	0.5...6	
<b>Solid core H05(07) V-U</b>	<b>mm<sup>2</sup></b>	<b>0.5...6</b>	
Stranded H07 V-R			
Flexible H05(07) V-K	mm <sup>2</sup>	0.5...6	
Flexible with ferrule	mm <sup>2</sup>	0.5...6	
Ferrule with plastic collar	mm <sup>2</sup>	0.5...6	
Stripping length	mm	12	
Screwdriver blade	mm	0.6 x 3.5	
According to norm			
Tightening torque range			
<b>Rated current, max.</b>	<b>A</b>	<b>38</b>	<b>34</b>
At ambient temperature		20°C	40°C
For conductor cross-section	mm <sup>2</sup>	6	
Overvoltage category		III	III II
Pollution severity		3	2 2
<b>Rated voltage</b>	<b>V</b>	<b>800</b>	<b>1000 1000</b>
Rated impulse voltage	kV	8	8 6
<b>UL / CUL (Use Group)</b>		<b>B</b>	<b>C D</b>
<b>Rated voltage</b>	<b>V</b>	<b>600</b>	<b>600 600</b>
<b>Rated current</b>	<b>A</b>	<b>35</b>	<b>35 5</b>
<b>AWG conductor</b>	<b>AWG</b>		<b>24-8</b>
<b>CSA (Use Group)</b>		<b>B</b>	<b>C D</b>
Rated voltage	V	600	600 600
Rated current	A	33	33 5
AWG conductor	AWG		24-8
<b>General data</b>			
Type of insulation material		PA GF	
UL 94 flammability rating		V-0	
Contact base material		Copper alloy	
Material of contact surface		tinned	
Pin dimensions = d	mm		
Solder eyelet Ø = D	mm		
Solder eyelet Ø tolerance	mm		

**Accessories**

**Note:** Refer to the Accessories chapter for additional accessories.

Coding		Order No.
	BV/SV 7.62HP K0	1937590000
<b>Shielding</b>		
	BVF 7.62HP SH150 4-6 KIT	1118480000
	BVF 7.62HP SH180 4-6 KIT	1118470000
	BVF 7.62HP SH210 4-6 KIT	1118490000
<b>Crimping tool</b>		
	PZ 6/5	9011460000
<b>Screwdriver</b>		
	SDS 0.6X3.5X100	9008330000
	SDS 0.8X4.5X125	

**Ordering data**

Solder pin length						
Colour						Black
Pitch 7.62 mm						
Poles	L1 (inch)	L2 (inch)	Qty.	Order No.		
2 / 4	15.24	0.600	3.81	0.150	36	2549320000
2 / 6	15.24	0.600	7.62	0.300	36	2628330000
2 / 8	15.24	0.600	11.43	0.450	40	2628690000
3 / 4	22.86	0.900	3.81	0.150	40	2628720000
3 / 6	22.86	0.900	7.62	0.300	35	2628730000
3 / 8	22.86	0.900	11.43	0.450	30	2628740000
4 / 4	30.48	1.200	3.81	0.150	30	2628780000
4 / 6	30.48	1.200	7.62	0.300	30	2628790000
4 / 8	30.48	1.200	11.43	0.450	25	2628800000
5 / 4	38.10	1.500	3.81	0.150	25	2628840000
5 / 6	38.10	1.500	7.62	0.300	25	2628850000
5 / 8	38.10	1.500	11.43	0.450	20	2628860000

**Representative deratings curve**

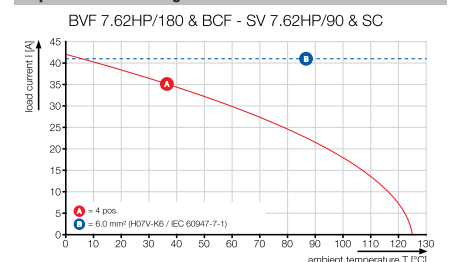

**BVFL 7.62HP../180 BCF 3.81 MF3**



Dimensioned drawing

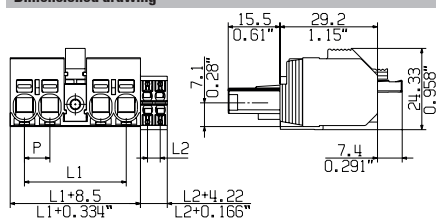

**BVFL 7.62HP../180 BCF 3.81 MF4**



Dimensioned drawing

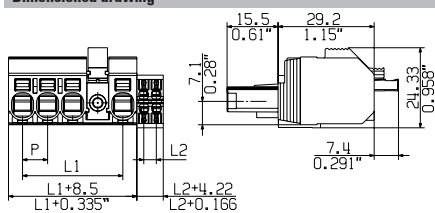

**Ordering data**

Solder pin length						
Colour						Black
Pitch 7.62 mm						
Poles	L1	(inch)	L2	(inch)	Qty.	Order No.
3/4	22.86	0.900	3.81	0.150	28	2549460000
3/6	22.86	0.900	7.62	0.300	28	2549470000
3/8	22.86	0.900	11.43	0.450	24	2549480000
4/4	30.48	1.200	3.81	0.150	30	2628900000
4/6	30.48	1.200	7.62	0.300	30	2628910000
4/8	30.48	1.200	11.43	0.450	25	2628920000
5/4	38.10	1.500	3.81	0.150	30	2628960000
5/6	38.10	1.500	7.62	0.300	25	2628970000
5/8	38.10	1.500	11.43	0.450	25	2628980000

**Ordering data**

Solder pin length						
Colour						Black
Pitch 7.62 mm						
Poles	L1	(inch)	L2	(inch)	Qty.	Order No.
4/4	30.48	1.200	3.81	0.150	24	1547590000
4/6	30.48	1.200	7.62	0.300	24	2549490000
4/8	30.48	1.200	11.43	0.450	20	2549500000
5/4	38.10	1.500	3.81	0.150	20	2549510000
5/6	38.10	1.500	7.62	0.300	20	2549520000
5/8	38.10	1.500	11.43	0.450	20	2549530000

Additional pole combinations on request

**Connectors in 7.62 mm pitch**  
**Series BV/SV 7.62 - connection up to 6 mm<sup>2</sup>**

**BVFL 7.62HP/./180 BCF 3.81 MSF**

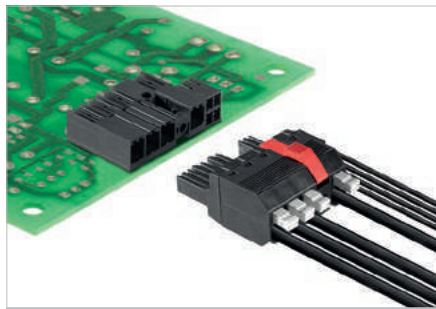

Hybrid female connector with power and signal contacts and adjustable actuator (pusher) featuring PUSH IN spring connection technology. Enables simultaneous connection of power, signals and shielding. Ideal for connecting servo and asynchronous drives. Meets the requirements of UL1059 for 600 V Use Group C. The pin arrangement guarantees more than 3 mm of touch-safety in accordance with IEC 61800-5-1. The snap-on middle flange decreases the space required by one pitch width.

The pluggable shield connection has a wide contact area on the device housing and does not need to be bolted.

**Product data**

IEC: 1000 V / 38 A / 0.5 - 6 mm<sup>2</sup>  
 UL: 600 V / 35 A / AWG 24 - 8



For additional articles and information, refer to [catalog.weidmueller.com](http://catalog.weidmueller.com)

**Note:**

- Technical specifications refer to the power contacts
- Technical data of signal contacts: 50V / 5A, stripping length 8mm
- Additional colours on request
- Rated current related to rated cross-section & min. No. of poles.
- Wire end ferrule with plastic collar to DIN 46228/4
- Wire end ferrule without plastic collar to DIN 46228/1
- Rated data refer only to the component itself. Clearance and creepage distances to other components are to be designed in accordance with the relevant application standards.
- Additional pole combinations on request
- MF2 and MSFX: X= Position of the middle flange e.g. MF2, MSFX3

**BVFL 7.62HP/./180 BCF 3.81 MSF2**



**Dimensioned drawing**

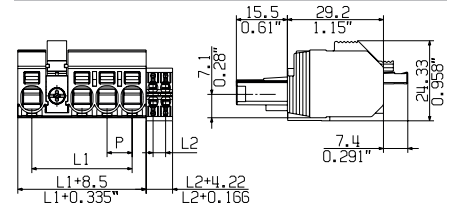

**Technical data**

In compliance with IEC 60664-1 / IEC 61984			
Clamping range, max.	mm <sup>2</sup>	0.5...6	
<b>Solid core H05(07) V-U</b>	<b>mm<sup>2</sup></b>	<b>0.5...6</b>	
Stranded H07 V-R			
Flexible H05(07) V-K	mm <sup>2</sup>	0.5...6	
Flexible with ferrule	mm <sup>2</sup>	0.5...6	
Ferrule with plastic collar	mm <sup>2</sup>	0.5...6	
Stripping length	mm	12	
Screwdriver blade	mm	0.6 x 3.5	
According to norm			
Tightening torque range			
<b>Rated current, max.</b>	<b>A</b>	<b>38</b>	<b>34</b>
At ambient temperature		20°C	40°C
For conductor cross-section	mm <sup>2</sup>	6	
Overvoltage category		III	III II
Pollution severity		3	2 2
<b>Rated voltage</b>	<b>V</b>	<b>800</b>	<b>1000 1000</b>
Rated impulse voltage	kV	8	8 6
<b>UL / CUL (Use Group)</b>		<b>B</b>	<b>C D</b>
<b>Rated voltage</b>	<b>V</b>	<b>600</b>	<b>600 600</b>
<b>Rated current</b>	<b>A</b>	<b>35</b>	<b>35 5</b>
<b>AWG conductor</b>	<b>AWG</b>	<b>24-8</b>	
<b>CSA (Use Group)</b>		<b>B</b>	<b>C D</b>
Rated voltage	V	600	600 600
Rated current	A	33	33 5
AWG conductor	AWG	24-8	
<b>General data</b>			
Type of insulation material		PA GF	
UL 94 flammability rating		V-0	
Contact base material		Copper alloy	
Material of contact surface		tinned	
Pin dimensions = d	mm		
Solder eyelet Ø = D	mm		
Solder eyelet Ø tolerance	mm		

**Accessories**

**Note:** Refer to the Accessories chapter for additional accessories.

Coding	Order No.
BV/SV 7.62HP K0	<b>1937590000</b>
<b>Shielding</b>	
BVF 7.62HP SH150 4-6 KIT	<b>1118480000</b>
BVF 7.62HP SH180 4-6 KIT	<b>1118470000</b>
BVF 7.62HP SH210 4-6 KIT	<b>1118490000</b>
<b>Crimping tool</b>	
PZ 6/5	<b>9011460000</b>
<b>Screwdriver</b>	
SDS 0.6X3.5X100	<b>9008330000</b>
SDS 0.8X4.5X125	

**Ordering data**

Solder pin length						
Colour						Black
Pitch 7.62 mm						
Poles	L1 (inch)	L2 (inch)	Qty.	Order No.		
2 / 4	15.24	0.600	3.81	0.150	36	<b>2549330000</b>
2 / 6	15.24	0.600	7.62	0.300	45	<b>2629020000</b>
2 / 8	15.24	0.600	11.43	0.450	40	<b>2629030000</b>
3 / 4	22.86	0.900	3.81	0.150	35	<b>2629060000</b>
3 / 6	22.86	0.900	7.62	0.300	30	<b>2629070000</b>
3 / 8	22.86	0.900	11.43	0.450	40	<b>2629080000</b>
4 / 4	30.48	1.200	3.81	0.150	30	<b>2629120000</b>
4 / 6	30.48	1.200	7.62	0.300	25	<b>2629130000</b>
4 / 8	30.48	1.200	11.43	0.450	30	<b>2629140000</b>
5 / 4	38.10	1.500	3.81	0.150	25	<b>2629180000</b>
5 / 6	38.10	1.500	7.62	0.300	20	<b>2629190000</b>
5 / 8	38.10	1.500	11.43	0.450	25	<b>2629200000</b>

**Representative deratings curve**

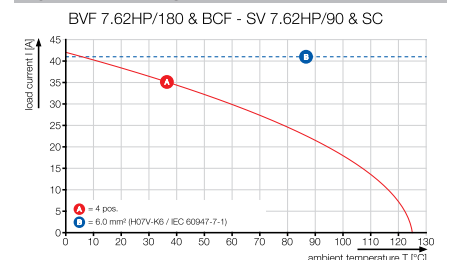

**BVFL 7.62HP../180 BCF 3.81 MSF3**



Dimensioned drawing

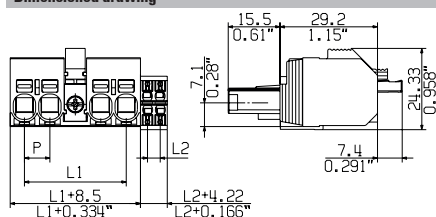

**BVFL 7.62HP../180 BCF 3.81 MSF4**



Dimensioned drawing

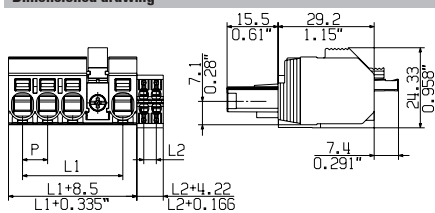

**Ordering data**

Solder pin length						
Colour						Black
Pitch 7.62 mm						
Poles	L1	(inch)	L2	(inch)	Qty.	Order No.
3/4	22.86	0.900	3.81	0.150	28	2549540000
3/6	22.86	0.900	7.62	0.300	28	2549550000
3/8	22.86	0.900	11.43	0.450	24	2549560000
4/4	30.48	1.200	3.81	0.150	30	2629240000
4/6	30.48	1.200	7.62	0.300	30	2629250000
4/8	30.48	1.200	11.43	0.450	25	2629260000
5/4	38.10	1.500	3.81	0.150	25	2629300000
5/6	38.10	1.500	7.62	0.300	25	2629310000
5/8	38.10	1.500	11.43	0.450	25	2629320000

**Ordering data**

Solder pin length						
Colour						Black
Pitch 7.62 mm						
Poles	L1	(inch)	L2	(inch)	Qty.	Order No.
4/4	30.48	1.200	3.81	0.150	42	1547600000
4/6	30.48	1.200	7.62	0.300	24	2549570000
4/8	30.48	1.200	11.43	0.450	20	2549580000
5/4	38.10	1.500	3.81	0.150	20	2549590000
5/6	38.10	1.500	7.62	0.300	20	2549600000
5/8	38.10	1.500	11.43	0.450	20	2549610000

Additional pole combinations on request

# OMNIMATE® Power for IT systems - scalable from 25 A to 76 A

## Custom-fit solutions for special requirements

**Increased compliance with standards and fewer compromises: OMNIMATE® Power for IT systems establishes a new level of excellence with its standard integrated details. These attributes streamline the design-in and approval processes and result in safer operations.**

Results for the application and advantages for the user: unlimited use in 400-V IT systems and touch safety according to IEC 61800-5-1 (+ 5 mm). The self-snapping one-handed safety flange enables intuitive and safe usage. Operational reliability is guaranteed by the automatic interlock feature during the plug-in process. The application-oriented design means that no compromises are necessary during the approval process.

### Uncompromised scalability

As much power as required, as little cost as needed: a device series for every power level and power type: scalable from 25 A/2.5 mm<sup>2</sup> to 41 A/6 mm<sup>2</sup> to 76 A/16 mm<sup>2</sup>.

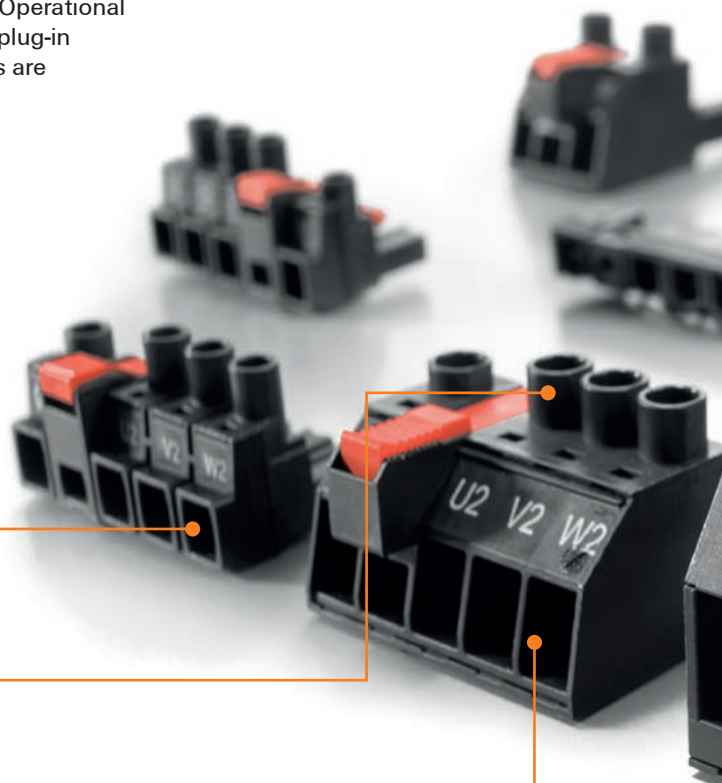

### IEC 61800-5-1 approval

No additional measures or compromises in the system suitable, touch-safe certification according to IEC 61800-5-1:  
+ 3.0 mm for 400 V TN systems,  
+ 5.5 mm for 400 V IT networks.

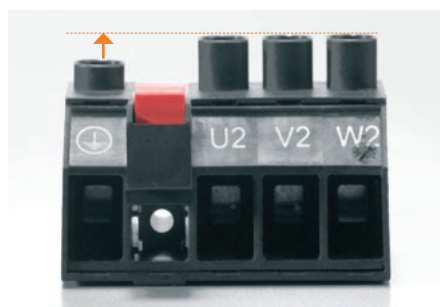

### Uncompromised power capabilities

Uncompromised means high power reserves for superior overload capacity even under the high ambient temperatures of real-world applications.

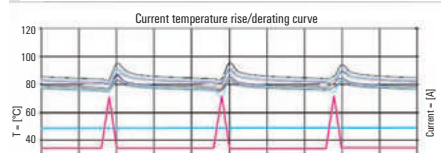
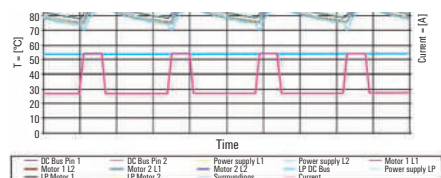

**Uncompromised safety**

Details such as insulated contact tips that ensure the pin header is touch-safe and automatic snap-in for a secure interlocking connection.

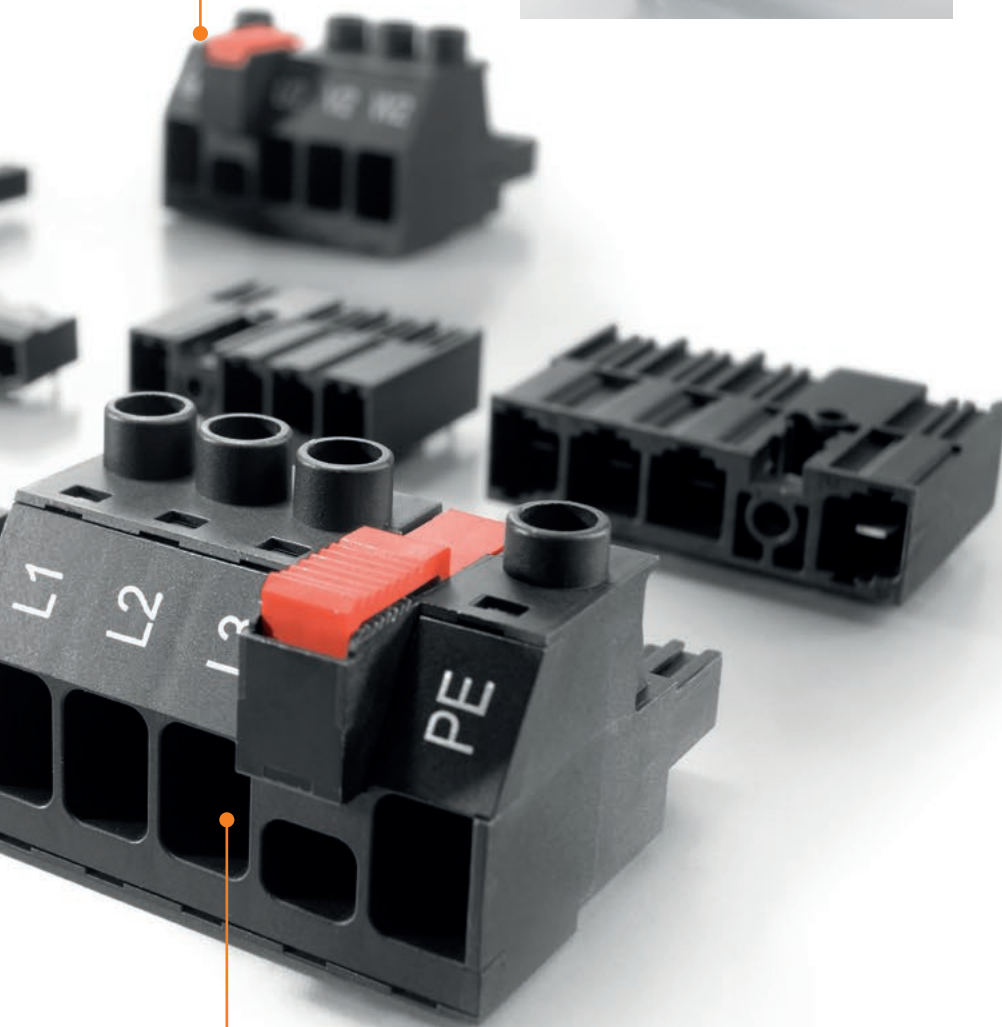
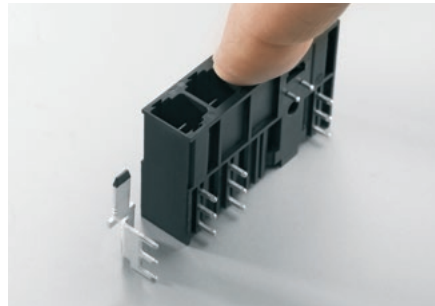
**UL approval without compromise**

No limitation for UL approval with 600-V applications: with optimised creepage and clearance distance even under difficult installation situations.

**600 V**c  US**Finger safety according to DIN EN 61800-5-1**

Since the end of 2007, device approval according to IEC Directive "Adjustable speed electrical power drive systems – Part 5-1: Safety requirements" requires that – regardless of the line-to-earth voltage – an additional finger safety interval exists (for example, + 3 mm for 400 V-TN systems (wire-to-earth voltage = 230 V), or + 5.5 mm for 400-V IT systems (wire-to-earth voltage up to 400 V in event of error)). An additional cover is required if the connection system, as a device section, does not fulfil these requirements. The OMNIMATE® Power HP product line already complies with the stricter IEC requirements for additional touch protection.

**Clearance and creepage distances, acc. to UL**

A 600-V connector must have the approval of the UL 1059 component directive – but the potential installation situations must first be taken into consideration. This allows you to avoid making approval compromises – such as UL 508C or incorporating complex additions such as coatings or protective hoods. The OMNIMATE® Power HP product line already complies with the UL requirements for 600-V creepage and clearance distances.

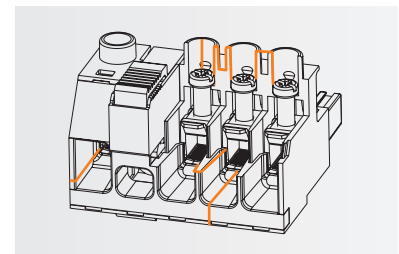

# Secure and efficient connection of power electronics devices

## PUSH IN connector with wire-ready function

High power applications necessitate connection by wires with huge cross sections, which are typically inflexible. Large PUSH IN connections are therefore difficult to plug in. Special tools are often needed for installation in narrow areas or for wiring with flexible wires without ferrules.

BUF 10.16 facilitates and accelerates this process and does not require additional tools. The operating lever which can be locked in the open position (pusher) makes it possible to insert conductors with short cladding or rigid insulation into the open terminal. This means that the proven PUSH IN function remains unrestricted while the terminal point, fixed in an open position, allows a comfortable and easy connection under difficult conditions. The result is a noticeable saving of time.

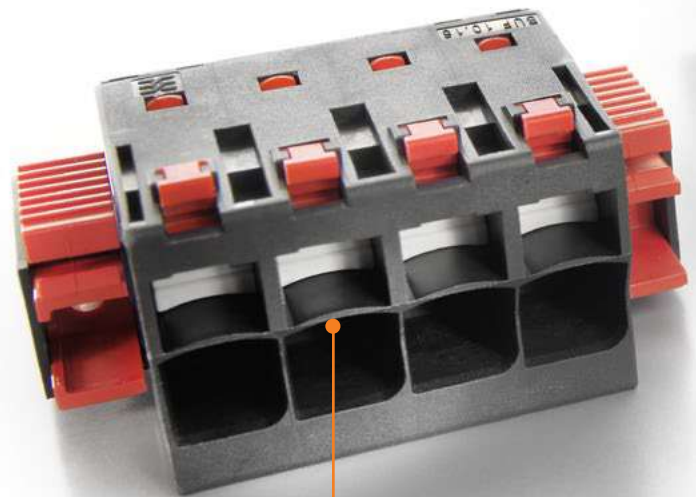
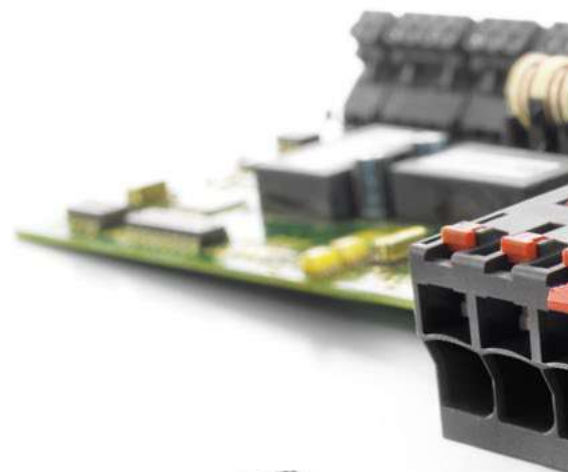

### Easy installation

PUSH IN technology with open position fixed clamping point for easy wiring of flexible wires without ferrules and wires with rigid insulation.





**Easy one hand operation**

Automatic locking by a centre flange with detent fixing and optional screw fixing.

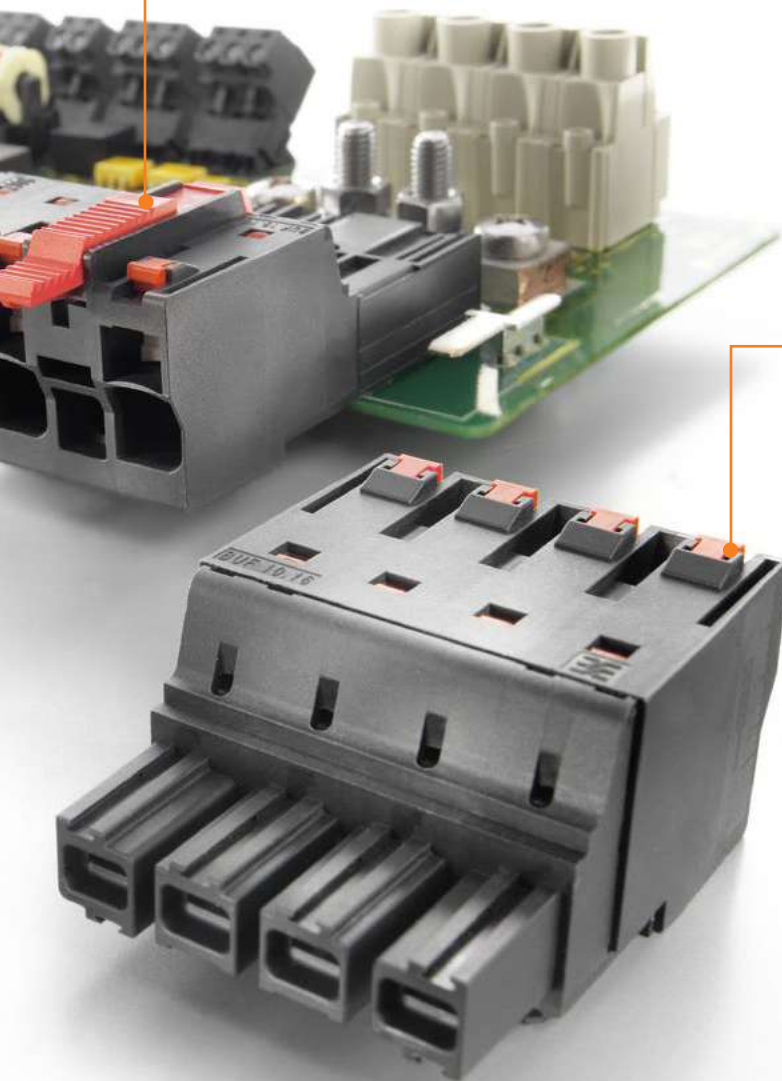
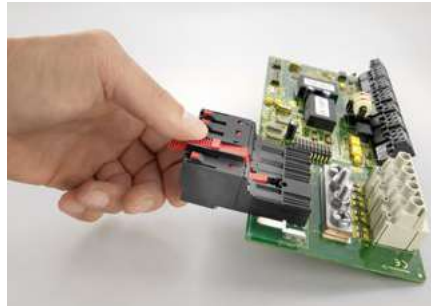
**Fast wiring**

The PUSH IN connection system allows tool-free connection of solid wires or wires with ferrules.



K

**Your special advantages**

- PUSH IN-technology with open position fixed clamping point
- Tool-free wiring of flexible wires without ferrules and wires with rigid insulation
- Easy one-hand operation of the connector
- Automatic locking by a centre flange with detent fixing and optional screw fixing



**Webcode: # 11407**

<http://www.OMNIMATE.net>

- = Wire-to-Board
- = Board-to-Board
- = Wire-to-Wire
- = Board-to-Wire

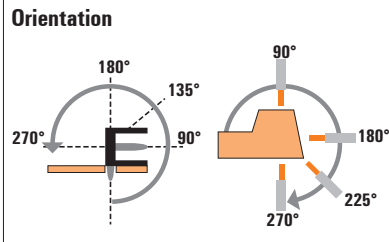
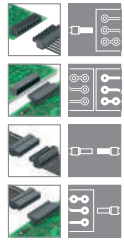

Pitch 7.62 mm



For IT networks



Type	SL	SL
Orientation	90°	90°
Flange options	MF2	MF3
Product code numbers	IEC: 630 V/24 A UL: 300 V/20 A	IEC: 630 V/24 A UL: 300 V/20 A

Type	Orientation	Flange options	Product code numbers		
			SL	SL	
Screw Clamping yoke	180°	MF2	○ ●		
		MF3		○ ●	
		MF4			
	180°	MF2			
		MF3			
		MF4			
	180°	MF2			
		MF3			
		MF4			
	Spring PUSH IN	180°	MF2		
			MF3		
			MF4		

MF2 = Centre snap flange at position 2  
 MF3 = Centre snap flange at position 3  
 MF4 = Centre snap flange at position 4

Male header



Solder connection

Pitch 7.62 mm

Pitch 10.16 mm



	SL	SV	SV	SV	SU	SU	SU
	90°	90° / 270°	90° / 270°	90° / 270°	90° / 270°	90° / 270°	90° / 270°
	MF4	MF2	MF3	MF4	MF2	MF3	MF4
	IEC: 630 V/24 A UL: 300 V/20 A	IEC: 1.000 V/41 A UL: 300 V/35 A	IEC: 1.000 V/41 A UL: 300 V/35 A	IEC: 1.000 V/41 A UL: 300 V/35 A	IEC: 1.000 V/76 A UL: 300 V/54 A	IEC: 1.000 V/76 A UL: 300 V/54 A	IEC: 1.000 V/76 A UL: 300 V/54 A
	○ ●						
		○ ●					
			○ ●				
				○ ●			
					○ ●		
						○ ●	
							○ ●



**Plug-in connector for IT power networks, pitch 7.62 mm**  
**BL/SL 7.62 IT series - connection up to 4 mm<sup>2</sup>**

**SL 7.62IT../90MF**

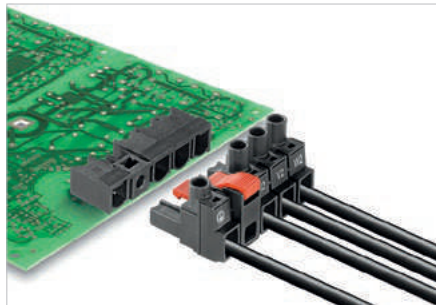

Male header available with 90° outlet direction and an optional solder flange attachment for IT power networks. UL approval in accordance with UL840 for 600 V with leading contact. In conjunction with the female plug BLZ 7.62 IT, meets the enhanced requirements for 5.5 mm touch-safety for IT power networks in acc. with IEC 61800-5-1 for 400 V relative to earth. When no female plug is present, the mating profile ensures that at least >1 mm of finger safety is present with a finger pressure of 20 N.

The middle-flange interlock feature decreases the space required by one pitch width compared to other standard solutions.

Available on request with screw flange mounting block or without flange.

**Product data**

IEC: 630 V / 29 A  
 UL: 300 V / 20 A



For additional articles and information, refer to [catalog.weidmuller.com](http://catalog.weidmuller.com)

**Note:**

- Additional colours on request
- Gold-plated contact surfaces on request
- Rated current related to rated cross-section & min. No. of poles.
- P on drawing = pitch
- Rated data refer only to the component itself. Clearance and creepage distances to other components are to be designed in accordance with the relevant application standards.
- MF2 and MSFX: X= Position of the middle flange e.g. MF2, MSF3

**SL 7.62IT../90MF2**

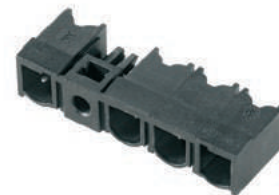

**Dimensioned drawing**

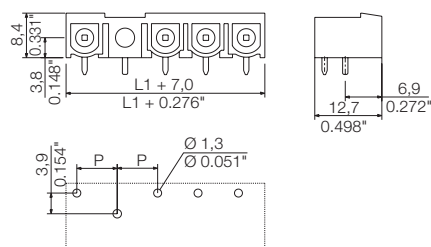

**Technical data**

**In compliance with IEC 60664-1 / IEC 61984**

Clamping range, max.			
<b>Solid core H05(07) V-U</b>			
Stranded H07 V-R			
Flexible H05(07) V-K			
Flexible with ferrule			
Ferrule with plastic collar			
Stripping length			
Screwdriver blade	mm		
According to norm			
Tightening torque range			
<b>Rated current, max.</b>	<b>A</b>	<b>29</b>	<b>25</b>
At ambient temperature		20°C	40°C
For conductor cross-section			
Overtoltage category		III	III
Pollution severity		3	2
<b>Rated voltage</b>	<b>V</b>	<b>400</b>	<b>500</b>
Rated impulse voltage	kV	6	6
<b>UL / CUL (Use Group)</b>		<b>B</b>	<b>C</b>
<b>Rated voltage</b>	<b>V</b>	<b>300</b>	<b>300</b>
<b>Rated current</b>	<b>A</b>	<b>20</b>	<b>20</b>
<b>AWG conductor</b>	<b>AWG</b>	-	-
<b>CSA (Use Group)</b>		<b>B</b>	<b>C</b>
Rated voltage	V	300	300
Rated current	A	20	20
AWG conductor	AWG	-	-
<b>General data</b>			
Type of insulation material		PBT GF	
UL 94 flammability rating		V-0	
Contact base material		Copper alloy	
Material of contact surface		tinned	
Pin dimensions = d	mm	1.0 x 1.0	
Solder eyelet Ø = D	mm	1.3	
Solder eyelet Ø tolerance	mm	+ 0,1	

**Accessories**

**Note:** Refer to the Accessories chapter for additional accessories.

Coding	Order No.
BLZ/SL KO OR BX	1573010000
BLZ/SL KO BK BX	1545710000

**Ordering data**

Solder pin length		3.2 mm		
Colour		Black		
Pitch		7.62 mm		
Pol.	L1	(inch)	Qty.	Order No.
2	15.24	0.600	100	1173610000
3	22.86	0.900	100	1173640000
4	30.48	1.200	100	1173730000
5	38.10	1.500	100	2629360000
6	45.72	1.800	100	2629480000

SL 7.62IT../90MF3



Dimensioned drawing

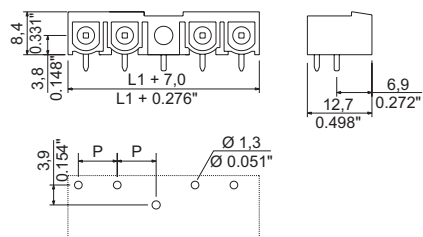

SL 7.62IT../90MF4



Dimensioned drawing

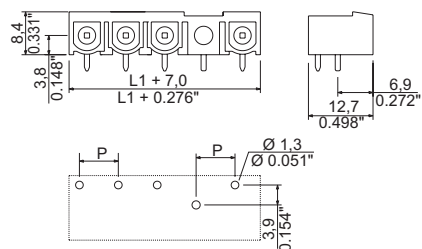

Ordering data

Solder pin length		3.2 mm			
Colour		Black			
Pitch		7.62 mm			
Pol.	L1	(inch)	Qty.	Order No.	
3	22.86	0.900	100	1173690000	
4	30.48	1.200	100	2629490000	
5	38.10	1.500	40	1398820000	
6	45.72	1.800	40	1398840000	

Ordering data

Solder pin length		3.2 mm			
Colour		Black			
Pitch		7.62 mm			
Pol.	L1	(inch)	Qty.	Order No.	
4	30.48	1.200	100	1173770000	
5	38.10	1.500	40	1398830000	
6	45.72	1.800	100	2629500000	



**Plug-in connector for IT power networks, pitch 7.62 mm**  
**BL/SL 7.62 IT series - connection up to 4 mm<sup>2</sup>**

**BLZ 7.62IT../180MF**

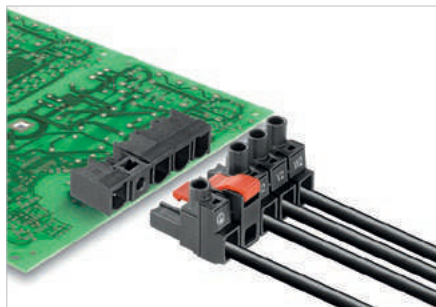

Female plug with 180° outlet direction for IT power networks. Meets the requirements of UL1059 for 600 V Use Group C. Leading contact in conjunction with the male header SL 7.62 IT. Meets the enhanced requirements for 5.5 mm touch-safety for IT power networks in acc. with IEC 61800-5-1 for 400 V relative to earth.

The self-snapping middle flange, which is optionally available with an additional fastening screw, decreases the space required by one pitch width compared to other standard solutions.

Optionally available without middle flange interlock

**Product data**

IEC: 630 V / 29 A / 0.08 - 4 mm<sup>2</sup>  
 UL: 600 V / 20 A / AWG 20 - 12



For additional articles and information, refer to [catalog.weidmuller.com](http://catalog.weidmuller.com)

**Note:**

- Additional colours on request
- Gold-plated contact surfaces on request
- Rated current related to rated cross-section & min. No. of poles.
- Wire end ferrule without plastic collar to DIN 46228/1
- Wire end ferrule with plastic collar to DIN 46228/4
- P on drawing = pitch
- Rated data refer only to the component itself. Clearance and creepage distances to other components are to be designed in accordance with the relevant application standards.
- MFX and MSFX: X= Position of the middle flange e.g. MF2, MSF3

**BLZ 7.62IT../180MF2**



**Dimensioned drawing**

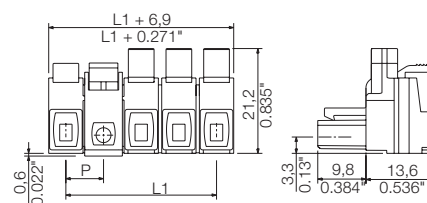

**Technical data**

**In compliance with IEC 60664-1 / IEC 61984**

Clamping range, max.	mm <sup>2</sup>	0.08...4
<b>Solid core H05(07) V-U</b>	<b>mm<sup>2</sup></b>	<b>0.08...4</b>
Stranded H07 V-R		
Flexible H05(07) V-K	mm <sup>2</sup>	0.08...4
Flexible with ferrule	mm <sup>2</sup>	0.2...2.5
Ferrule with plastic collar	mm <sup>2</sup>	0.2...2.5
Stripping length	mm	7
Screwdriver blade	mm	0.6 x 3.5
According to norm		DIN 5264
Tightening torque range	Nm	0.4...0.5

**Rated current, max.** **A** **29** **25**  
 At ambient temperature 20°C 40°C

For conductor cross-section	mm <sup>2</sup>	2.5
Overtoltage category		III III II
Pollution severity		3 2 2

**Rated voltage** **V** **400** **500** **630**  
 Rated impulse voltage kV 6 6 4

**UL / CUL (Use Group)** **B** **C** **D**

**Rated voltage** **V** **600** **600** **600**  
**Rated current** **A** **20** **20** **5**

**AWG conductor** **AWG** **20-12**  
**CSA (Use Group)** **B** **C** **D**

Rated voltage	V	600	600	600
Rated current	A	20	20	5
AWG conductor	AWG	20-12		

**General data**

Type of insulation material		PBT
UL 94 flammability rating		V-0
Contact base material		Copper alloy
Material of contact surface		tinned
Pin dimensions = d	mm	
Solder eyelet Ø = D	mm	
Solder eyelet Ø tolerance	mm	

**Accessories**

**Note:** Refer to the Accessories chapter for additional accessories.

Coding	Order No.
BLZ/SL KO OR BX	<b>1573010000</b>
BLZ/SL KO BK BX	<b>1545710000</b>
Screwdriver	
SDS 0.6X3.5X100	<b>9008330000</b>
SDIS 0.6X3.5X100	<b>9008390000</b>

**Ordering data**

Solder pin length				
Colour	Black			
Pitch	7.62 mm			
Pol.	L1	(inch)	Qty.	Order No.
2	15.24	0.600	70	<b>1173490000</b>
3	22.86	0.900	50	<b>1173500000</b>
4	30.48	1.200	40	<b>1173520000</b>
5	38.10	1.500	50	<b>2629690000</b>
6	45.72	1.800	50	<b>2629740000</b>

**Representative deratings curve**

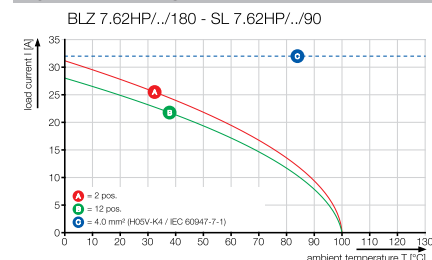

BLZ 7.62IT../180MF3



Dimensioned drawing

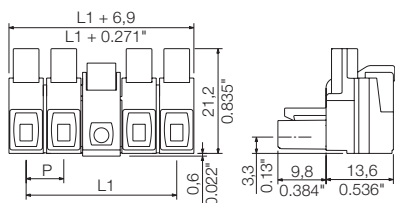

BLZ 7.62IT../180MF4



Dimensioned drawing

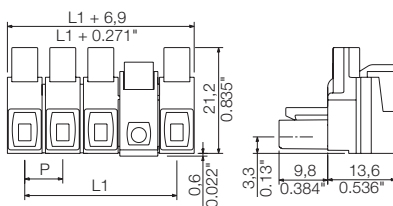

Ordering data

Solder pin length					
Colour					Black
Pitch 7.62 mm					
Pol.	L1	(inch)	Qty.	Order No.	
3	22.86	0.900	50	1173510000	
4	30.48	1.200	50	2629750000	
5	38.10	1.500	30	1398880000	
6	45.72	1.800	25	1398900000	

Ordering data

Solder pin length					
Colour					Black
Pitch 7.62 mm					
Pol.	L1	(inch)	Qty.	Order No.	
4	30.48	1.200	40	1173530000	
5	38.10	1.500	30	1398890000	
6	45.72	1.800	25	1398910000	



Additional deratings curves

BLZ 7.62HP../180 - SL 7.62HP../90

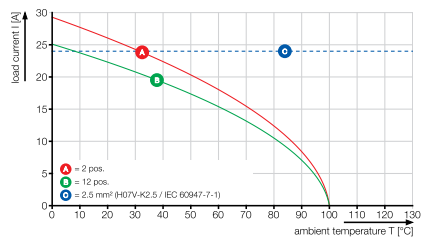

**Plug-in connector for IT power networks, pitch 7.62 mm**  
**BV/SV 7.62 IT series - connection up to 6 mm<sup>2</sup>**

**SV-SMT 7.62IT/./90MF**

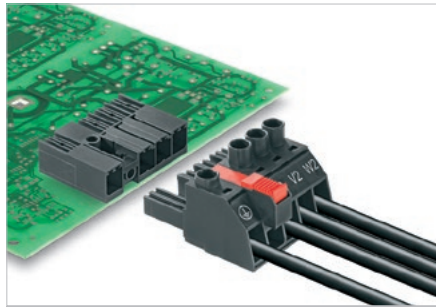

Male header with 90° outlet direction with optional solder flange attachment and leading PE contact for IT networks. UL approval in accordance with UL840 for 600 V. In combination with the female plug BVZ 7.62IT meets the enhanced requirements for 5.5 mm of touch safety for IT networks in acc. with IEC61800-5-1 for 400 V relative to earth. If no female plug is present, the mating profile still ensures that at least > 1 mm of finger safety is present with a finger pressure of 20 N.

Variants: flange, screw flange and middle flange fastening.

The high-temperature-resistant OMNIMATE® Power male header with THR (through-hole reflow) technology, suitable for the SMT process.

**Technical data**

**In compliance with IEC 60664-1 / IEC 61984**

Clamping range, max.			
<b>Solid core H05(07) V-U</b>			
Stranded H07 V-R			
Flexible H05(07) V-K			
Flexible with ferrule			
Ferrule with plastic collar			
Stripping length			
Screwdriver blade	mm		
According to norm			
Tightening torque range			
<b>Rated current, max.</b>	<b>A</b>	<b>41</b>	<b>41</b>
At ambient temperature		20°C	40°C
For conductor cross-section			
Overvoltage category		III	III II
Pollution severity		3	2 2
<b>Rated voltage</b>	<b>V</b>	<b>630</b>	<b>630 1000</b>
Rated impulse voltage	kV	6	6 6
<b>UL / CUL (Use Group)</b>		<b>B</b>	<b>C D</b>

<b>Rated voltage</b>			
<b>Rated current</b>			
<b>AWG conductor</b>	<b>AWG</b>		
<b>CSA (Use Group)</b>		<b>B</b>	<b>C D</b>

Rated voltage		
Rated current		
<b>AWG conductor</b>	<b>AWG</b>	-

<b>General data</b>		
Type of insulation material		PA GF
UL 94 flammability rating		V-0
Contact base material		Copper alloy
Material of contact surface		tinned
Pin dimensions = d	mm	0.8 x 1.0
Solder eyelet Ø = D	mm	1.3
Solder eyelet Ø tolerance	mm	+ 0,1

**Product data**

IEC: 1000 V / 41 A  
 UL:



For additional articles and information, refer to [catalog.weidmueller.com](http://catalog.weidmueller.com)

**Note:**

- Additional colours on request
- Rated current related to rated cross-section & min. No. of poles.
- P on drawing = pitch
- Rated data refer only to the component itself. Clearance and creepage distances to other components are to be designed in accordance with the relevant application standards.

**SV-SMT 7.62IT/./90MF2 Box**



**Dimensioned drawing**

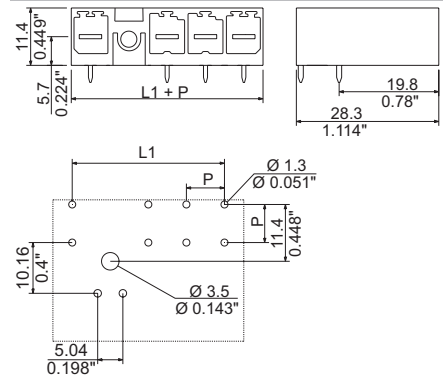

**Ordering data**

<b>Solder pin length</b>	2.6 mm		
<b>Colour</b>	Black		
<b>Pitch</b>	7.62 mm		
<b>Pol.</b>	<b>L1</b>	<b>(inch)</b>	<b>Qty. Order No.</b>
2	15.24	0.600	50 <b>2499530000</b>
3	22.86	0.900	50 <b>2499720000</b>
4	30.48	1.200	48 <b>2499740000</b>
5	38.10	1.800	50 <b>2499760000</b>



SV-SMT 7.62IT../90MF3 Box



Dimensioned drawing

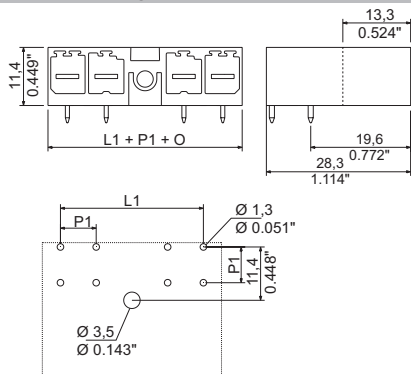

Ordering data

Solder pin length		2.6 mm	
Colour		Black	
Pitch		7.62 mm	
Pol.	L1	(inch)	Qty. Order No.
3	22.86	0.900	50 2499730000
4	30.48	1.200	48 2499750000
5	38.10	1.800	50 2499770000

SV-SMT 7.62IT../90MF4 Box



Dimensioned drawing

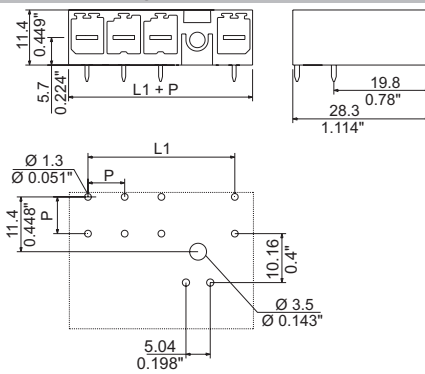

Ordering data

Solder pin length		2.6 mm	
Colour		Black	
Pitch		7.62 mm	
Pol.	L1	(inch)	Qty. Order No.
4	30.48	1.200	48 2454110000
5	38.10	1.800	50 2499780000

**Plug-in connector for IT power networks, pitch 7.62 mm**  
**BV/SV 7.62 IT series - connection up to 6 mm<sup>2</sup>**

**SV-SMT 7.62IT../270MF**

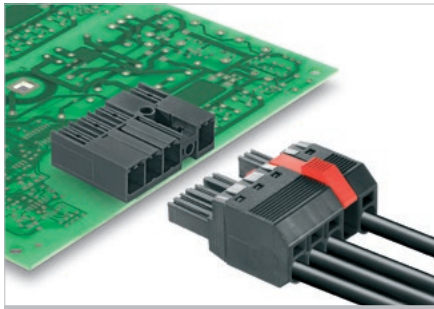

Male header with 270° outlet direction with optional solder flange attachment and leading PE contact for IT networks. UL approval in accordance with UL840 for 600 V. In combination with the female plug BVZ 7.62IT meets the enhanced requirements for 5.5 mm of touch safety for IT networks in acc. with IEC61800-5-1 for 400 V relative to earth. When no female plug is present, the mating profile ensures that at least > 1 mm of finger safety is present with a finger pressure of 20 N.

Variants: flange, screw flange and middle flange fastening.

The high-temperature-resistant OMNIMATE® Power male header with THR (through-hole reflow) technology, suitable for the SMT process.

**Technical data**

<b>In compliance with IEC 60664-1 / IEC 61984</b>			
Clamping range, max.			
<b>Solid core H05(07) V-U</b>			
Stranded H07 V-R			
Flexible H05(07) V-K			
Flexible with ferrule			
Ferrule with plastic collar			
Stripping length			
Screwdriver blade	mm		
According to norm			
Tightening torque range			
<b>Rated current, max.</b>	<b>A</b>	<b>41</b>	<b>41</b>
At ambient temperature		20°C	40°C
For conductor cross-section			
Overvoltage category		III	III II
Pollution severity		3	2 2
<b>Rated voltage</b>	<b>V</b>	<b>630</b>	<b>630 1000</b>
Rated impulse voltage	kV	6	6 6
<b>UL / CUL (Use Group)</b>		<b>B</b>	<b>C D</b>
<b>Rated voltage</b>			
<b>Rated current</b>			
<b>AWG conductor</b>	<b>AWG</b>		
<b>CSA (Use Group)</b>		<b>B</b>	<b>C D</b>
Rated voltage			
Rated current			
<b>AWG conductor</b>	<b>AWG</b>		
<b>General data</b>			
Type of insulation material		PA GF	
UL 94 flammability rating		V-0	
Contact base material		Copper alloy	
Material of contact surface		tinned	
Pin dimensions = d	mm	0.8 x 1.0	
Solder eyelet Ø = D	mm	1.3	
Solder eyelet Ø tolerance	mm	+ 0,1	

**Product data**

IEC: 1000 V / 41 A  
 UL:



For additional articles and information, refer to [catalog.weidmueller.com](http://catalog.weidmueller.com)

**Note:**

- Additional colours on request
- Rated current related to rated cross-section & min. No. of poles.
- P on drawing = pitch
- Rated data refer only to the component itself. Clearance and creepage distances to other components are to be designed in accordance with the relevant application standards.

**SV-SMT 7.62IT../270MF2 Box**



**Dimensioned drawing**

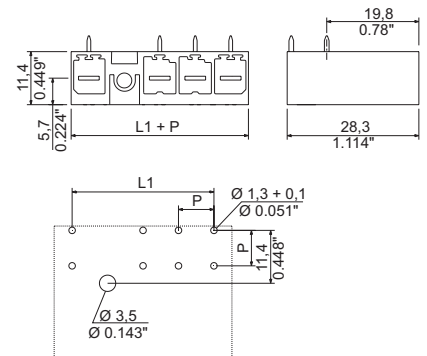

**Ordering data**

<b>Solder pin length</b>	3.5 mm		
<b>Colour</b>	Black		
<b>Pitch</b>	7.62 mm		
<b>Pol.</b>	<b>L1</b>	<b>(inch)</b>	<b>Qty. Order No.</b>
2	15.24	0.600	50 <b>2498800000</b>
3	22.86	0.900	50 <b>2499010000</b>
4	30.48	1.200	50 <b>2499030000</b>

**Accessories**

**Note:** Refer to the Accessories chapter for additional accessories.

Coding	Order No.
BV/SV 7.62HP KO	1937590000



SV-SMT 7.62IT../270MF3 Box



Dimensioned drawing

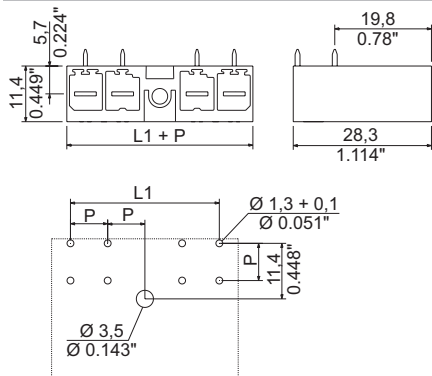

Ordering data

Solder pin length		3.5 mm	
Colour		Black	
Pitch		7.62 mm	
Pol.	L1	(inch)	Qty. Order No.
3	22.86	0.900	50 2499020000
4	30.48	1.200	50 2499040000

SV-SMT 7.62IT../270MF4 Box



Dimensioned drawing

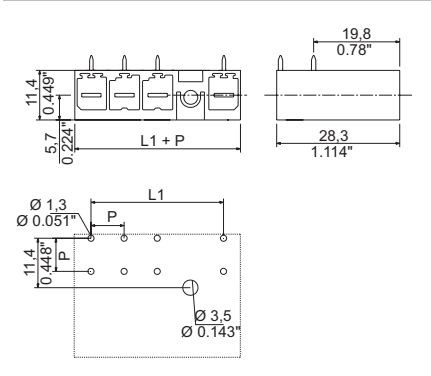

Ordering data

Solder pin length		3.5 mm	
Colour		Black	
Pitch		7.62 mm	
Pol.	L1	(inch)	Qty. Order No.
4	30.48	1.200	50 2499050000



**Plug-in connector for IT power networks, pitch 7.62 mm**  
**BV/SV 7.62 IT series - connection up to 6 mm<sup>2</sup>**

**SV 7.62IT/./90MF**

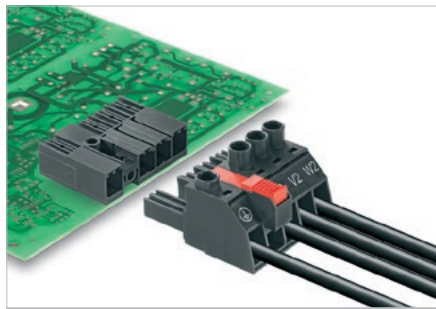

Male header with 90° outlet direction with optional solder flange attachment and leading PE contact for IT power networks. UL approval in accordance with UL840 for 600 V In combination with the female plug BVZ 7.62 IT meets the enhanced requirements for 5.5 mm of touch safety for IT power networks in acc. with IEC 61800-5-1 for 400 V relative to earth. Even when no female plug is present, the mating profile ensures that at least >1 mm of touch safety is present with a finger pressure of 20 N.

The middle-flange interlock feature decreases the space required by one pitch width compared to other standard solutions.

Available on request with screw flange mounting block or without flange.

**Product data**

IEC: 1000 V / 41 A  
 UL: 300 V / 40.5 A



For additional articles and information, refer to [catalog.weidmueller.com](http://catalog.weidmueller.com)

**Note:**

- Additional colours on request
- Rated current related to rated cross-section & min. No. of poles.
- P on drawing = pitch
- Rated data refer only to the component itself. Clearance and creepage distances to other components are to be designed in accordance with the relevant application standards.
- MFX and MSFX: X= Position of the middle flange e.g. MF2, MSF3

**SV 7.62IT/./90MF2**



**Dimensioned drawing**

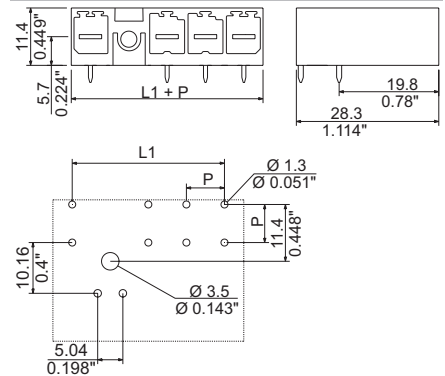

**Technical data**

**In compliance with IEC 60664-1 / IEC 61984**

Clamping range, max.			
<b>Solid core H05(07) V-U</b>			
Stranded H07 V-R			
Flexible H05(07) V-K			
Flexible with ferrule			
Ferrule with plastic collar			
Stripping length			
Screwdriver blade	mm		
According to norm			
Tightening torque range			
<b>Rated current, max.</b>	<b>A</b>	<b>41</b>	<b>41</b>
At ambient temperature		20°C	40°C
For conductor cross-section			
Overvoltage category		III	III II
Pollution severity		3	2 2
<b>Rated voltage</b>	<b>V</b>	<b>630</b>	<b>630 1000</b>
Rated impulse voltage	kV	6	6 6
<b>UL / CUL (Use Group)</b>		<b>B</b>	<b>C D</b>

<b>Rated voltage</b>	<b>V</b>	<b>300</b>	<b>300</b>	<b>600</b>
<b>Rated current</b>	<b>A</b>	<b>40.5</b>	<b>40.5</b>	<b>5</b>
<b>AWG conductor</b>	<b>AWG</b>			
<b>CSA (Use Group)</b>		<b>B</b>	<b>C</b>	<b>D</b>
Rated voltage	V	300	300	600
Rated current	A	35	35	5
AWG conductor	AWG			

<b>General data</b>				
Type of insulation material		PA GF		
UL 94 flammability rating		V-0		
Contact base material		Copper alloy		
Material of contact surface		tinned		
Pin dimensions = d	mm	0.8 x 1.0		
Solder eyelet Ø = D	mm	1.3		
Solder eyelet Ø tolerance	mm	+ 0,1		

**Accessories**

**Note:** Refer to the Accessories chapter for additional accessories.

Coding		Order No.
	BV/SV 7.62HP KO	1937590000
<b>Mounting foot</b>		
	BV/SV7.62HP MOFU GR	1937600000

**Ordering data**

<b>Solder pin length</b>	3.5 mm			
<b>Colour</b>	Black			
<b>Pitch</b>	7.62 mm			
Pol.	L1	(inch)	Qty.	Order No.
2	15.24	0.600	78	1156540000
3	22.86	0.900	60	1156550000
4	30.48	1.200	48	1156580000

SV 7.62IT/./90MF3



Dimensioned drawing

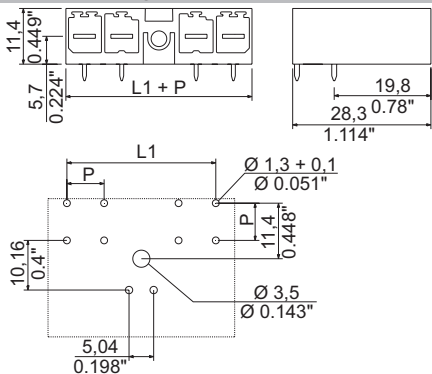

Ordering data

Solder pin length		3.5 mm	
Colour		Black	
Pitch		7.62 mm	
Pol.	L1	(inch)	Order No.
3	22.86	0.900	1156570000
4	30.48	1.200	1519190000

SV 7.62IT/./90MF4



Dimensioned drawing

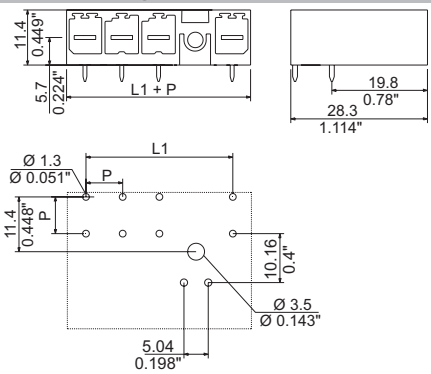

Ordering data

Solder pin length		3.5 mm	
Colour		Black	
Pitch		7.62 mm	
Pol.	L1	(inch)	Order No.
4	30.48	1.200	1156590000

**Plug-in connector for IT power networks, pitch 7.62 mm**  
**BV/SV 7.62 IT series - connection up to 6 mm<sup>2</sup>**

**SV 7.62IT.././270MF**

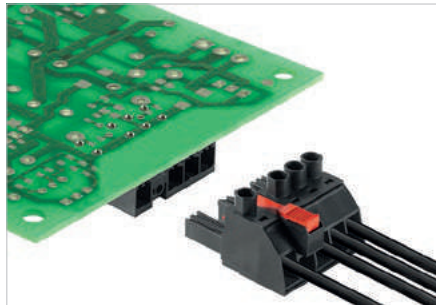

Male header with 270° outlet direction with a leading PE contact for IT power networks. UL approval in accordance with UL840 for 600 V In combination with the female plug BVZ 7.62 IT meets the enhanced requirements for 5.5 mm of touch safety for IT power networks in acc. with IEC 61800-5-1 for 400 V relative to earth. Even when no female plug is present, the mating profile ensures that at least >1 mm of touch safety is present with a finger pressure of 20 N.

The middle-flange interlock feature decreases the space required by one pitch width compared to other standard solutions.

Available on request with screw flange mounting block or without flange.

**Product data**

IEC: 1000 V / 41 A  
 UL: 300 V / 40.5 A



For additional articles and information, refer to [catalog.weidmueller.com](http://catalog.weidmueller.com)

**Note:**

- Additional colours on request
- Rated current related to rated cross-section & min. No. of poles.
- P on drawing = pitch
- Rated data refer only to the component itself. Clearance and creepage distances to other components are to be designed in accordance with the relevant application standards.
- MFX and MSFX: X= Position of the middle flange e.g. MF2, MSF3

**SV 7.62IT.././270MF2**



**Dimensioned drawing**

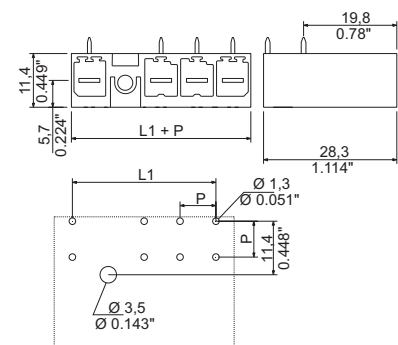

**Technical data**

**In compliance with IEC 60664-1 / IEC 61984**

Clamping range, max.			
<b>Solid core H05(07) V-U</b>			
Stranded H07 V-R			
Flexible H05(07) V-K			
Flexible with ferrule			
Ferrule with plastic collar			
Stripping length			
Screwdriver blade	mm		
According to norm			
Tightening torque range			
<b>Rated current, max.</b>	<b>A</b>	<b>41</b>	<b>41</b>
At ambient temperature		20°C	40°C
For conductor cross-section			
Overvoltage category		III	III II
Pollution severity		3	2 2
<b>Rated voltage</b>	<b>V</b>	<b>630</b>	<b>630 1000</b>
Rated impulse voltage	kV	6	6 6
<b>UL / CUL (Use Group)</b>		<b>B</b>	<b>C D</b>
<b>Rated voltage</b>	<b>V</b>	<b>300</b>	<b>300 600</b>
<b>Rated current</b>	<b>A</b>	<b>40.5</b>	<b>40.5 5</b>
<b>AWG conductor</b>	<b>AWG</b>		<b>-</b>
<b>CSA (Use Group)</b>		<b>B</b>	<b>C D</b>
Rated voltage	V	300	300 600
Rated current	A	35	35 5
AWG conductor	AWG		-
<b>General data</b>			
Type of insulation material		PA GF	
UL 94 flammability rating		V-0	
Contact base material		Copper alloy	
Material of contact surface		tinned	
Pin dimensions = d	mm	0.8 x 1.0	
Solder eyelet Ø = D	mm	1.3	
Solder eyelet Ø tolerance	mm	+ 0,1	

**Accessories**

**Note:** Refer to the Accessories chapter for additional accessories.

Coding	Order No.
BV/SV 7.62HP KO	1937590000
	
<b>Mounting foot</b>	
BV/SV7.62HP MOFU GR	1937600000

**Ordering data**

<b>Solder pin length</b>	3.5 mm			
<b>Colour</b>	Black			
<b>Pitch</b>	7.62 mm			
<b>Pol.</b>	<b>L1</b>	<b>(inch)</b>	<b>Qty.</b>	<b>Order No.</b>
2	15.24	0.600	78	1156490000
3	22.86	0.900	60	1156500000
4	30.48	1.200	48	1156520000

SV 7.62IT../270MF3



Dimensioned drawing

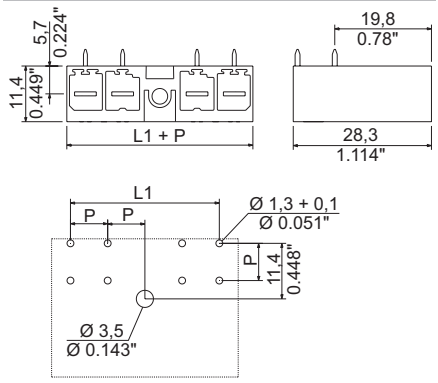

Ordering data

Solder pin length		3.5 mm	
Colour		Black	
Pitch		7.62 mm	
Pol.	L1	(inch)	Qty. Order No.
3	22.86	0.900	60 1156510000
4	30.48	1.200	48 1519200000

SV 7.62IT../270MF4



Dimensioned drawing

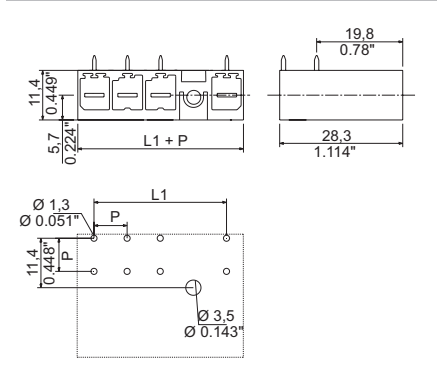

Ordering data

Solder pin length		3.5 mm	
Colour		Black	
Pitch		7.62 mm	
Pol.	L1	(inch)	Qty. Order No.
4	30.48	1.200	48 1156530000

**Plug-in connector for IT power networks, pitch 7.62 mm**  
**BV/SV 7.62 IT series - connection up to 6 mm<sup>2</sup>**

**BVZ 7.62IT../180MF**

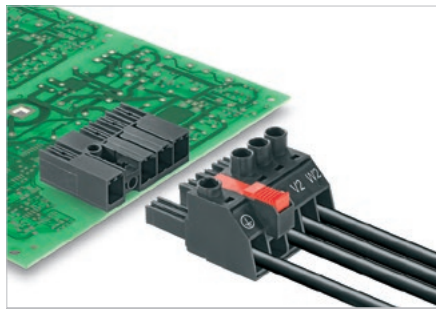

Female plug for IT power networks. Meets the requirements of UL1059 for 600 V Use Group C. Leading PE contact in combination with the male header SV 7.62 IT. Meets the enhanced requirements for 5.5 mm of touch safety for IT power networks in acc. with IEC 61800-5-1 for 400 V relative to earth.

The self-locking middle flange which can also be optionally screwed, reduces the space requirements by one pitch width compared to conventional solutions.

Optionally available without middle flange interlock.

**Product data**

IEC: 1000 V / 41 A / 0.2 - 6 mm<sup>2</sup>  
 UL: 600 V / 40.5 A / AWG 24 - 8



For additional articles and information, refer to [catalog.weidmuller.com](http://catalog.weidmuller.com)

**Note:**

- Additional colours on request
- Rated current related to rated cross-section & min. No. of poles.
- Wire end ferrule with plastic collar to DIN 46228/4
- Wire end ferrule without plastic collar to DIN 46228/1
- P on drawing = pitch
- Rated data refer only to the component itself. Clearance and creepage distances to other components are to be designed in accordance with the relevant application standards.
- MFX and MSFX: X= Position of the middle flange e.g. MF2, MSF3

**BVZ 7.62IT../180MF2**



**Dimensioned drawing**

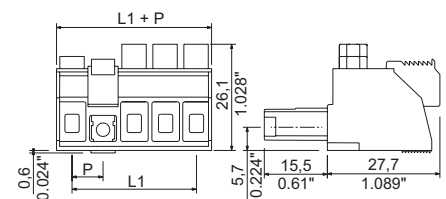

**Technical data**

**In compliance with IEC 60664-1 / IEC 61984**

Clamping range, max.	mm <sup>2</sup>	0.2...10
<b>Solid core H05(07) V-U</b>	<b>mm<sup>2</sup></b>	<b>0.2...6</b>
Stranded H07 V-R		
Flexible H05(07) V-K	mm <sup>2</sup>	0.5...6
Flexible with ferrule	mm <sup>2</sup>	0.25...6
Ferrule with plastic collar	mm <sup>2</sup>	0.25...6
Stripping length	mm	12
Screwdriver blade	mm	0.6 x 3.5

According to norm

Tightening torque range	Nm	0.5...0.6		
<b>Rated current, max.</b>	<b>A</b>	<b>41</b>	<b>41</b>	
At ambient temperature	20°C	40°C		
For conductor cross-section	mm <sup>2</sup>	6		
Overvoltage category		III	III	
Pollution severity		3	2	
<b>Rated voltage</b>	<b>V</b>	<b>800</b>	<b>1000</b>	<b>1000</b>
Rated impulse voltage	kV	8	8	6
<b>UL / CUL (Use Group)</b>		<b>B</b>	<b>C</b>	<b>D</b>

<b>Rated voltage</b>	<b>V</b>	<b>600</b>	<b>600</b>	<b>600</b>
<b>Rated current</b>	<b>A</b>	<b>40.5</b>	<b>40.5</b>	<b>5</b>
<b>AWG conductor</b>	<b>AWG</b>	<b>24-8</b>		
<b>CSA (Use Group)</b>		<b>B</b>	<b>C</b>	<b>D</b>
Rated voltage	V	600	600	600
Rated current	A	40.5	40.5	5
AWG conductor	AWG	24-8		

**General data**

Type of insulation material		PA GF
UL 94 flammability rating		V-0
Contact base material		Copper alloy
Material of contact surface		tinned
Pin dimensions = d	mm	
Solder eyelet Ø = D	mm	
Solder eyelet Ø tolerance	mm	

**Accessories**

**Note:** Refer to the Accessories chapter for additional accessories.

Coding	Order No.
BV/SV 7.62HP K0	1937590000
<b>Strain relief</b>	
BV/SV 7.62HP/02 ZE GR	1937550000
BV/SV 7.62HP/04 ZE GR	1937560000
<b>Screwdriver</b>	
SDS 0.8X4.5X125	9009020000
<b>Crosshead screwdriver</b>	
SDK PH1	9008480000

**Ordering data**

<b>Solder pin length</b>				
<b>Colour</b>	<b>Black</b>			
<b>Pitch</b>	<b>7.62 mm</b>			
Pol.	L1	(inch)	Qty.	Order No.
2	15.24	0.600	52	1156710000
3	22.86	0.900	40	1156720000
4	30.48	1.200	32	1156740000

**Representative deratings curve**

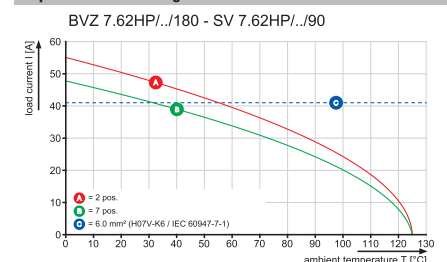



**BVZ 7.62IT../180MF3**



Dimensioned drawing

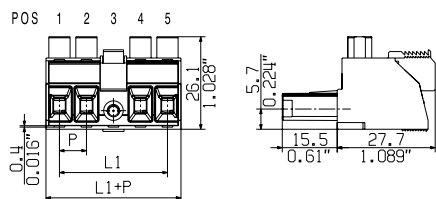

**Ordering data**

Solder pin length					
Colour					Black
Pitch 7.62 mm					
Pol.	L1	(inch)	Qty.	Order No.	
3	22.86	0.900	40	1156730000	
4	30.48	1.200	32	1312730000	

**BVZ 7.62IT../180MF4**



Dimensioned drawing

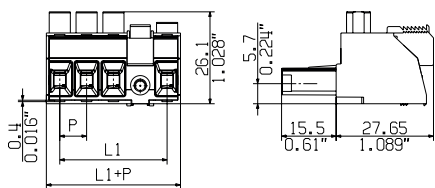

**Ordering data**

Solder pin length					
Colour					Black
Pitch 7.62 mm					
Pol.	L1	(inch)	Qty.	Order No.	
4	30.48	1.200	32	1156750000	

**Additional deratings curves**

BVZ 7.62HP../180 - SV 7.62HP../180

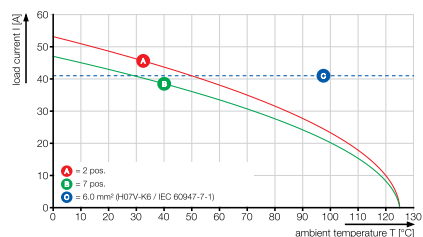

**Plug-in connector for IT power networks, pitch 10.16 mm**  
**BU/SU 10.16 IT series - connection up to 16 mm<sup>2</sup>**

**SU 10.16IT../90MF**

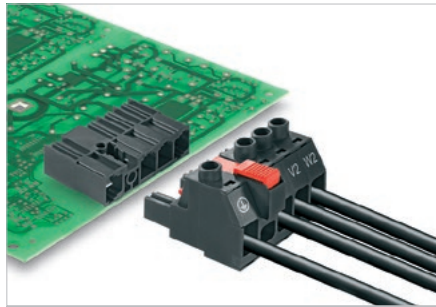

Male header with 90° outlet direction and optional solder flange with leading PE contact. UL approval in accordance with UL840 for 600 V. In combination with the female plug BUZ 10.16 IT meets the enhanced requirements for 5.5 mm of touch safety on IT power networks in acc. with IEC 61800-5-1 for 400 V relative to earth. Even when no female plug is present, the mating profile ensures that at least >1 mm of touch safety is present with a finger pressure of 20 N.

The middle-flange interlock feature decreases the space required by one pitch width compared to other standard solutions.

Available on request with screw flange mounting block or without flange.

**Product data**

IEC: 1000 V / 78.3 A  
 UL: 300 V / 60 A



For additional articles and information, refer to [catalog.weidmueller.com](http://catalog.weidmueller.com)

**Note:**

- Additional colours on request
- Rated current related to rated cross-section & min. No. of poles.
- Wire end ferrule with plastic collar to DIN 46228/4
- Wire end ferrule without plastic collar to DIN 46228/1
- P on drawing = pitch
- Rated data refer only to the component itself. Clearance and creepage distances to other components are to be designed in accordance with the relevant application standards.
- MFX and MSFX: X= Position of the middle flange e.g. MF2, MSF3

**SU 10.16IT../90MF2**



**Dimensioned drawing**

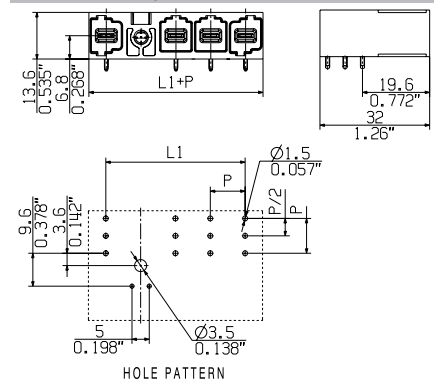

**Ordering data**

<b>Solder pin length</b>		3.5 mm	
<b>Colour</b>		Black	
<b>Pitch</b>		10.16 mm	
Pol.	L1	(inch)	Qty. Order No.
2	20.32	0.800	60 1156650000
3	30.48	1.200	42 1156670000
4	40.64	1.600	36 1156690000

**Technical data**

<b>In compliance with IEC 60664-1 / IEC 61984</b>			
Clamping range, max.			
<b>Solid core H05(07) V-U</b>			
Stranded H07 V-R			
Flexible H05(07) V-K			
Flexible with ferrule			
Ferrule with plastic collar			
Stripping length			
Screwdriver blade	mm		
According to norm			
Tightening torque range			
<b>Rated current, max.</b>	<b>A</b>	<b>78.3</b>	<b>70.6</b>
At ambient temperature		20°C	40°C
For conductor cross-section			
Overtoltage category		III	III II
Pollution severity		3	2 2
<b>Rated voltage</b>	<b>V</b>	<b>690</b>	<b>1000 1000</b>
Rated impulse voltage	kV	8	8 6
<b>UL / CUL (Use Group)</b>		<b>B</b>	<b>C D</b>
<b>Rated voltage</b>	<b>V</b>	<b>300</b>	<b>300 600</b>
<b>Rated current</b>	<b>A</b>	<b>60</b>	<b>60 5</b>
<b>AWG conductor</b>	<b>AWG</b>		<b>-</b>
<b>CSA (Use Group)</b>		<b>B</b>	<b>C D</b>
Rated voltage	V	300	300 600
Rated current	A	60	60 5
AWG conductor	AWG		-
<b>General data</b>			
Type of insulation material		PA GF	
UL 94 flammability rating		V-0	
Contact base material		Copper alloy	
Material of contact surface		silver-plated	
Pin dimensions = d	mm	1.2 x 1.1	
Solder eyelet Ø = D	mm	1.6	
Solder eyelet Ø tolerance	mm	+ 0,1	

**Accessories**

**Note:** Refer to the Accessories chapter for additional accessories.

Coding	Order No.
KO BU/SU10.16HP / BV/SV7.62	1824410000
KO BU/SU10.16HP WT	2592600000

SU 10.16IT../90MF3



Dimensioned drawing

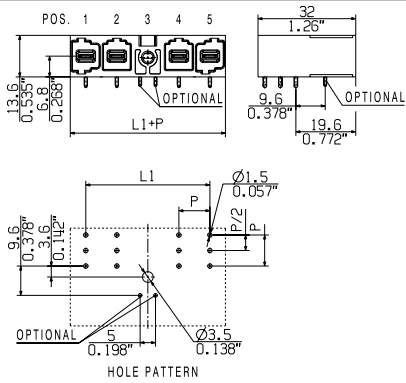

Ordering data

Solder pin length		3.5 mm	
Colour		Black	
Pitch		10.16 mm	
Pol.	L1	(inch)	Qty. Order No.
3	30.48	1.200	42 <b>1156680000</b>
4	20.32	0.800	36 <b>2629730000</b>

SU 10.16IT../90MF4



Dimensioned drawing

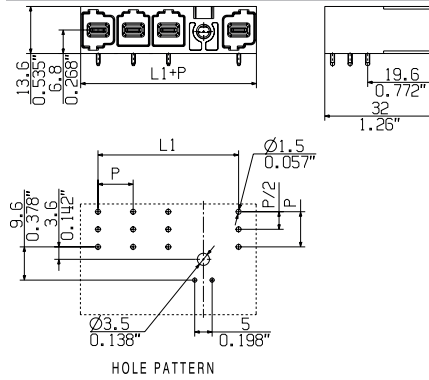

Ordering data

Solder pin length		3.5 mm	
Colour		Black	
Pitch		10.16 mm	
Pol.	L1	(inch)	Qty. Order No.
4	40.64	1.600	36 <b>1156700000</b>

**Plug-in connector for IT power networks, pitch 10.16 mm**  
**BU/SU 10.16 IT series - connection up to 16 mm<sup>2</sup>**

**SU 10.16IT../270MF**

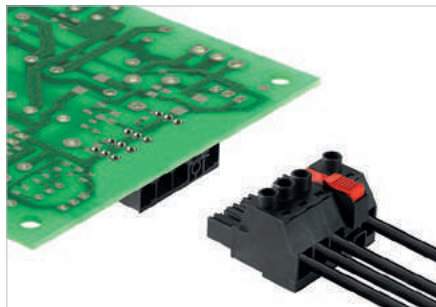

Male header with 270° outlet direction with leading PE contact. UL approval in accordance with UL840 for 600 V. In combination with the female plug BUZ 10.16 IT meets the enhanced requirements for 5.5 mm of touch safety on IT power networks in acc. with IEC 61800-5-1 for 400 V relative to earth. Even when no female plug is present, the mating profile ensures that at least >1 mm of touch safety is present with a finger pressure of 20 N.

The middle-flange interlock feature decreases the space required by one pitch width compared to other standard solutions.

Available on request with screw flange mounting block or without flange.

**Product data**

IEC: 1000 V / 78.3 A  
 UL: 300 V / 60 A



For additional articles and information, refer to [catalog.weidmuller.com](http://catalog.weidmuller.com)

**Note:**

- Additional colours on request
- Rated current related to rated cross-section & min. No. of poles.
- Wire end ferrule with plastic collar to DIN 46228/4
- Wire end ferrule without plastic collar to DIN 46228/1
- P on drawing = pitch
- Rated data refer only to the component itself. Clearance and creepage distances to other components are to be designed in accordance with the relevant application standards.
- MFX and MSFX: X= Position of the middle flange e.g. MF2, MSF3

**SU 10.16IT../270MF2**



**Dimensioned drawing**

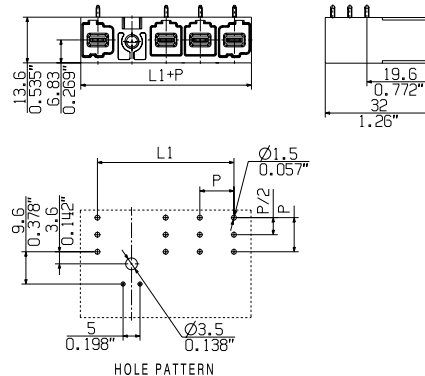

**Technical data**

**In compliance with IEC 60664-1 / IEC 61984**

Clamping range, max.			
<b>Solid core H05(07) V-U</b>			
Stranded H07 V-R			
Flexible H05(07) V-K			
Flexible with ferrule			
Ferrule with plastic collar			
Stripping length			
Screwdriver blade	mm		
According to norm			
Tightening torque range			
<b>Rated current, max.</b>	<b>A</b>	<b>78.3</b>	<b>70.6</b>
At ambient temperature		20°C	40°C
For conductor cross-section			
Overtoltage category		III	III II
Pollution severity		3	2 2
<b>Rated voltage</b>	<b>V</b>	<b>690</b>	<b>1000 1000</b>
Rated impulse voltage	kV	8	8 6
<b>UL / CUL (Use Group)</b>		<b>B</b>	<b>C D</b>
<b>Rated voltage</b>	<b>V</b>	<b>300</b>	<b>300 600</b>
<b>Rated current</b>	<b>A</b>	<b>60</b>	<b>60 5</b>
<b>AWG conductor</b>	<b>AWG</b>		<b>-</b>
<b>CSA (Use Group)</b>		<b>B</b>	<b>C D</b>
Rated voltage	V	300	300 600
Rated current	A	60	60 5
AWG conductor	AWG		-
<b>General data</b>			
Type of insulation material		PA GF	
UL 94 flammability rating		V-0	
Contact base material		Copper alloy	
Material of contact surface		silver-plated	
Pin dimensions = d	mm	1.2 x 1.1	
Solder eyelet Ø = D	mm	1.6	
Solder eyelet Ø tolerance	mm	+ 0,1	

**Accessories**

**Note:** Refer to the Accessories chapter for additional accessories.

Coding	Order No.
 KO BU/SU10.16HP / BV/SV7.62	<b>18244 10000</b>
KO BU/SU10.16HP WT	<b>2592600000</b>

**Ordering data**

<b>Solder pin length</b>	3.5 mm		
<b>Colour</b>	Black		
<b>Pitch</b>	10.16 mm		
<b>Pol.</b>	<b>L1</b>	<b>(inch)</b>	<b>Qty. Order No.</b>
2	20.32	0.800	60 <b>1157310000</b>
3	30.48	1.200	42 <b>1157320000</b>
4	40.64	1.600	36 <b>1157340000</b>

SU 10.16IT../270MF3



Dimensioned drawing

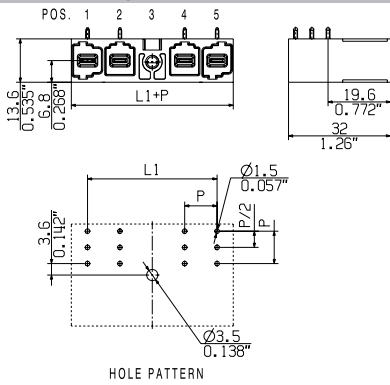

Ordering data

Solder pin length		3.5 mm	
Colour		Black	
Pitch		10.16 mm	
Pol.	L1	(inch)	Qty. Order No.
3	30.48	1.200	42 <b>1157330000</b>
4	20.32	0.800	36 <b>2630190000</b>

SU 10.16IT../270MF4



Dimensioned drawing

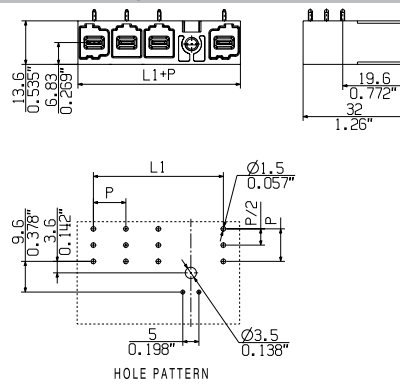

Ordering data

Solder pin length		3.5 mm	
Colour		Black	
Pitch		10.16 mm	
Pol.	L1	(inch)	Qty. Order No.
4	40.64	1.600	36 <b>1157350000</b>

**Plug-in connector for IT power networks, pitch 10.16 mm**  
**BU/SU 10.16 IT series - connection up to 16 mm<sup>2</sup>**

**BUZ 10.16IT../180MF**

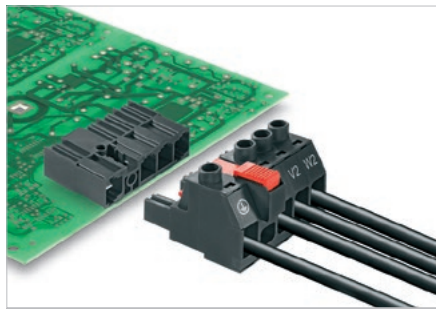

Female plug with 180° outlet direction for IT power networks. Meets the requirements of UL1059 for 600 V Use Group C. Leading PE contact in combination with the male header SU 7.62 IT. Meets the enhanced requirements for 5.5 mm of touch safety on IT power networks in acc. with IEC 61800-5-1 for 400 V relative to earth.

The self-locking middle flange which can also be optionally screwed, reduces the space requirements by one pitch width compared to conventional solutions.

Optionally available without middle flange interlock.

**Product data**

IEC: 1000 V / 78.3 A / 0.2 - 16 mm<sup>2</sup>  
 UL: 600 V / 60 A / AWG 22 - 4



For additional articles and information, refer to [catalog.weidmueller.com](http://catalog.weidmueller.com)

**Note:**

- Additional colours on request
- Rated current related to rated cross-section & min. No. of poles.
- Wire end ferrule with plastic collar to DIN 46228/4
- Wire end ferrule without plastic collar to DIN 46228/1
- P on drawing = pitch
- Rated data refer only to the component itself. Clearance and creepage distances to other components are to be designed in accordance with the relevant application standards.
- MFX and MSFX: X= Position of the middle flange e.g. MF2, MSF3

**BUZ 10.16IT../180MF2**



**Dimensioned drawing**

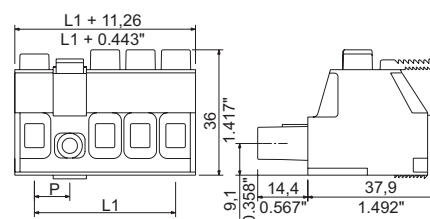

**Technical data**

**In compliance with IEC 60664-1 / IEC 61984**

Clamping range, max.	mm <sup>2</sup>	0.2...16
<b>Solid core H05(07) V-U</b>	<b>mm<sup>2</sup></b>	<b>0.2...16</b>
Stranded H07 V-R		...16
Flexible H05(07) V-K	mm <sup>2</sup>	0.5...16
Flexible with ferrule	mm <sup>2</sup>	0.25...16
Ferrule with plastic collar	mm <sup>2</sup>	0.25...16
Stripping length	mm	12
Screwdriver blade	mm	1.0 x 5.5

According to norm

Tightening torque range	Nm	1.2...1.5
<b>Rated current, max.</b>	<b>A</b>	<b>78.3 70.6</b>
At ambient temperature		20°C 40°C

For conductor cross-section	mm <sup>2</sup>	16
Overvoltage category		III III II
Pollution severity		3 2 2

<b>Rated voltage</b>	<b>V</b>	<b>1000 1000 1000</b>
Rated impulse voltage	kV	8 8 6

**UL / CUL (Use Group)**

<b>Rated voltage</b>	<b>V</b>	<b>600 600 600</b>
<b>Rated current</b>	<b>A</b>	<b>60 60 5</b>

**AWG conductor**

<b>AWG conductor</b>	<b>AWG</b>	<b>22-4</b>
----------------------	------------	-------------

**CSA (Use Group)**

<b>Rated voltage</b>	<b>V</b>	<b>300 600 600</b>
<b>Rated current</b>	<b>A</b>	<b>60 60 5</b>
<b>AWG conductor</b>	<b>AWG</b>	<b>22-4</b>

**General data**

Type of insulation material	PA GF
UL 94 flammability rating	V-0
Contact base material	Copper alloy
Material of contact surface	silver-plated
Pin dimensions = d	mm
Solder eyelet Ø = D	mm
Solder eyelet Ø tolerance	mm

**Accessories**

**Note:** Refer to the Accessories chapter for additional accessories.

Coding	Order No.
KO BU/SU10.16HP / BV/SV7.62	<b>18244 10000</b>
KO BU/SU10.16HP WT	<b>259260000</b>
Screwdriver	
SDIS 1.0X5.5X125	<b>90084 10000</b>
SDK PZ2	<b>9008540000</b>
Crosshead screwdriver	
SDIK PZ2	<b>9008890000</b>

**Ordering data**

<b>Solder pin length</b>				
<b>Colour</b>	<b>Black</b>			
<b>Pitch</b>	<b>10.16 mm</b>			
Pol.	L1	(inch)	Qty.	Order No.
2	20.32	0.800	30	<b>1156600000</b>
3	30.48	1.200	21	<b>1156610000</b>
4	40.64	1.600	18	<b>1156630000</b>

**Representative deratings curve**

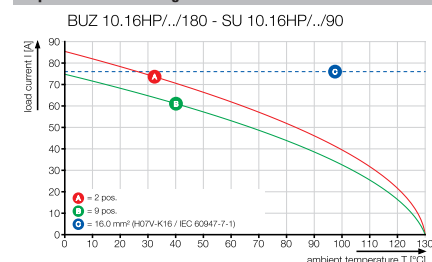

**BUZ 10.16IT../180MF3**



Dimensioned drawing

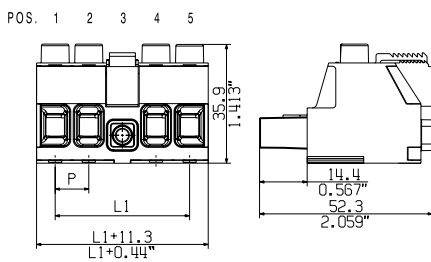

**Ordering data**

Solder pin length				
Colour				Black
Pitch 10.16 mm				
Pol.	L1	(inch)	Qty.	Order No.
3	30.48	1.200	21	1156620000
4	40.64	1.600	18	2000430000

**BUZ 10.16IT../180MF4**



Dimensioned drawing

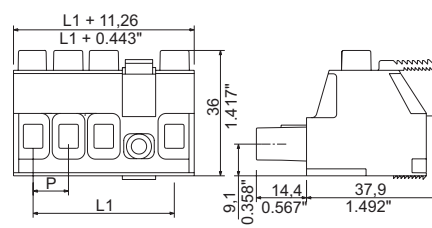

**Ordering data**

Solder pin length				
Colour				Black
Pitch 10.16 mm				
Pol.	L1	(inch)	Qty.	Order No.
4	40.64	1.600	18	1156640000

**Additional deratings curves**

BUZ 10.16HP../180 - SU 10.16HP../180

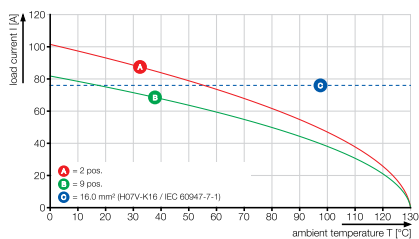

**Plug-in connector for IT power networks, pitch 10.16 mm**  
**BU/SU 10.16 IT series - connection up to 16 mm<sup>2</sup>**

**BUF 10.16IT../180MF**

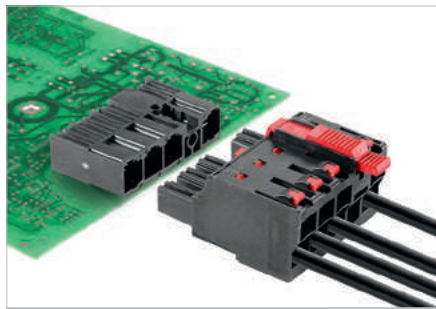

Female plug in 180° outlet direction for IT networks. Fulfills the requirements of UL1059 for 600 V Use Group C with leading PE contact when used with SU 10.16 IT male header. Fulfills the expanded requirements for 5.5 mm of touch protection (400 V relative to earth), according to IEC 61800-5-1.

The middle flange interlocks automatically and is optionally available with screw connection. It decreases the space required by one pole when compared to other solutions.

Available optionally without middle flange interlock.

**Technical data**

In compliance with IEC 60664-1 / IEC 61984			
Clamping range, max.	mm <sup>2</sup>	2.5...16	
<b>Solid core H05(07) V-U</b>	<b>mm<sup>2</sup></b>	<b>2.5...10</b>	
Stranded H07 V-R		...16	
Flexible H05(07) V-K	mm <sup>2</sup>	2.5...16	
Flexible with ferrule	mm <sup>2</sup>	2.5...16	
Ferrule with plastic collar	mm <sup>2</sup>	2.5...16	
Stripping length	mm	18	
Screwdriver blade	mm	0.8 x 4.0	
According to norm		DIN 5264	
Tightening torque range			
<b>Rated current, max.</b>	<b>A</b>	<b>76</b>	<b>70</b>
At ambient temperature		20°C	40°C
For conductor cross-section	mm <sup>2</sup>	16	
Overvoltage category		III	III II
Pollution severity		3	2 2
<b>Rated voltage</b>	<b>V</b>	<b>1000</b>	<b>1000 1000</b>
Rated impulse voltage	kV	8	8 8
<b>UL / CUL (Use Group)</b>	<b>B C D</b>	<b>B C D</b>	
<b>Rated voltage</b>	<b>V</b>	<b>600</b>	<b>600</b>
<b>Rated current</b>	<b>A</b>	<b>55</b>	<b>55</b>
<b>AWG conductor</b>	<b>AWG</b>	<b>12-4</b>	
<b>CSA (Use Group)</b>	<b>B C D</b>	<b>B C D</b>	
Rated voltage	V		
Rated current	A		
AWG conductor	AWG		
General data			
Type of insulation material		PA GF	
UL 94 flammability rating		V-0	
Contact base material		Copper alloy	
Material of contact surface		silver-plated	
Pin dimensions = d	mm		
Solder eyelet Ø = D			
Solder eyelet Ø tolerance	mm		

**Product data**

IEC: 1000 V / 76 A / 2.5 - 16 mm<sup>2</sup>  
 UL: 600 V / 55 A / AWG 12 - 4



For additional articles and information, refer to [catalog.weidmuller.com](http://catalog.weidmuller.com)

**Note:**

- Additional colours on request
- Rated current related to rated cross-section & min. No. of poles.
- Wire end ferrule with plastic collar to DIN 46228/4
- Wire end ferrule without plastic collar to DIN 46228/1
- P on drawing = pitch
- Rated data refer only to the component itself. Clearance and creepage distances to other components are to be designed in accordance with the relevant application standards.

**BUF 10.16IT../180MF2**



**Dimensioned drawing**

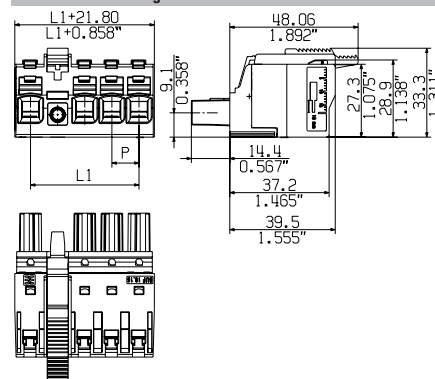

**Accessories**

**Note:** Refer to the Accessories chapter for additional accessories.

Coding	Order No.
KO BU/SU10.16HP / BV/SV7.62	<b>1824410000</b>
KO BU/SU10.16HP WT	<b>2592600000</b>
Screwdriver	
SDS 0.8X4.5X125	<b>9009020000</b>

**Ordering data**

Solder pin length				
Colour	Black			
Pitch	10.16 mm			
Pol.	L1	(inch)	Qty.	Order No.
2	20.32	0.800	36	<b>2493160000</b>
3	30.48	1.200	28	<b>2493180000</b>
4	40.64	1.600	24	<b>2493200000</b>
5	50.80	2.000	36	<b>2586660000</b>
6	60.96	2.400	50	<b>2586770000</b>

**Representative deratings curve**

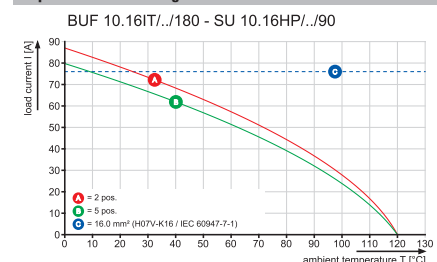



BUF 10.16IT../180MF3



Dimensioned drawing

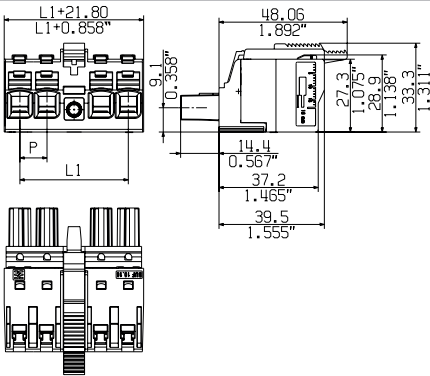

Ordering data

Solder pin length					
Colour					Black
Pitch 10.16 mm					
Pol.	L1	(inch)	Qty.	Order No.	
3	30.48	1.200	28	2493190000	
4	40.64	1.600	24	2493210000	
5	50.80	2.000	50	2586700000	
6	60.96	2.400	50	2586780000	

BUF 10.16IT../180MF4



Dimensioned drawing

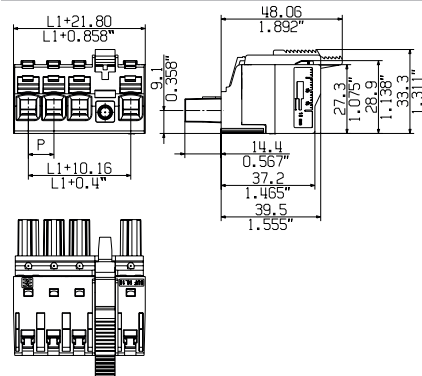

Ordering data

Solder pin length					
Colour					Black
Pitch 10.16 mm					
Pol.	L1	(inch)	Qty.	Order No.	
4	40.64	1.600	24	2544950000	
5	50.80	2.000	50	2586710000	
6	60.96	2.400	50	2586790000	

Additional deratings curves

BUF 10.16IT../180 - SU 10.16HP../90

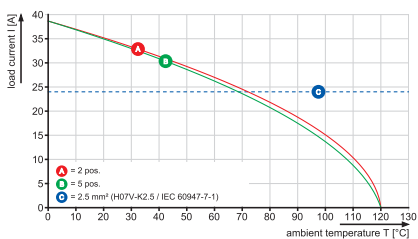

**Plug-in connector for IT power networks, pitch 10.16 mm**  
**BU/SU 10.16 IT series - connection up to 16 mm<sup>2</sup>**

**BUF 10.16IT../180MSF**

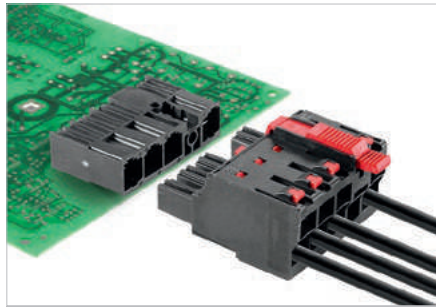

Female plug in 180° outlet direction for IT networks. Fulfills the requirements of UL1059 for 600 V Use Group C with leading PE contact when used with SU 10.16 IT male header. Fulfills the expanded requirements for 5.5 mm of touch protection (400 V relative to earth), according to IEC 61800-5-1.

The middle flange interlocks automatically and is optionally available with screw connection. It decreases the space required by one pole when compared to other solutions.

Available optionally without middle flange interlock.

**Technical data**

In compliance with IEC 60664-1 / IEC 61984			
Clamping range, max.	mm <sup>2</sup>	2.5...16	
<b>Solid core H05(07) V-U</b>	<b>mm<sup>2</sup></b>	<b>2.5...10</b>	
Stranded H07 V-R		...16	
Flexible H05(07) V-K	mm <sup>2</sup>	2.5...16	
Flexible with ferrule	mm <sup>2</sup>	2.5...16	
Ferrule with plastic collar	mm <sup>2</sup>	2.5...16	
Stripping length	mm	18	
Screwdriver blade	mm	0.8 x 4.0	
According to norm		DIN 5264	
Tightening torque range			
<b>Rated current, max.</b>	<b>A</b>	<b>76</b>	<b>70</b>
At ambient temperature		20°C	40°C
For conductor cross-section	mm <sup>2</sup>	16	
Overvoltage category		III	III II
Pollution severity		3	2 2
<b>Rated voltage</b>	<b>V</b>	<b>1000</b>	<b>1000 1000</b>
Rated impulse voltage	kV	8	8 8
<b>UL / CUL (Use Group)</b>		<b>B</b>	<b>C D</b>
<b>Rated voltage</b>	<b>V</b>	<b>600</b>	<b>600</b>
<b>Rated current</b>	<b>A</b>	<b>55</b>	<b>55</b>
<b>AWG conductor</b>	<b>AWG</b>		<b>12-4</b>
<b>CSA (Use Group)</b>		<b>B</b>	<b>C D</b>
Rated voltage	V		
Rated current	A		
AWG conductor	AWG		
General data			
Type of insulation material		PA GF	
UL 94 flammability rating		V-0	
Contact base material		Copper alloy	
Material of contact surface		silver-plated	
Pin dimensions = d	mm		
Solder eyelet Ø = D			
Solder eyelet Ø tolerance	mm		

**Product data**

IEC: 1000 V / 76 A / 2.5 - 16 mm<sup>2</sup>  
 UL: 600 V / 55 A / AWG 12 - 4



For additional articles and information, refer to [catalog.weidmuller.com](http://catalog.weidmuller.com)

**Note:**

- Additional colours on request
- Rated current related to rated cross-section & min. No. of poles.
- Wire end ferrule with plastic collar to DIN 46228/4
- Wire end ferrule without plastic collar to DIN 46228/1
- P on drawing = pitch
- Rated data refer only to the component itself. Clearance and creepage distances to other components are to be designed in accordance with the relevant application standards.

**BUF 10.16IT../180MSF2**



**Dimensioned drawing**

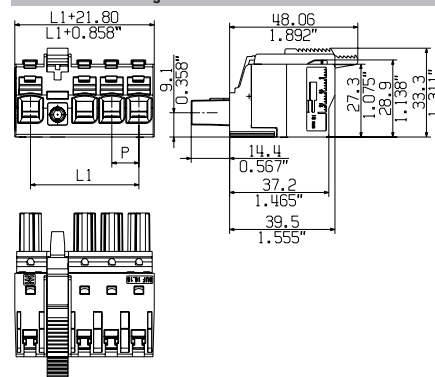

**Accessories**

**Note:** Refer to the Accessories chapter for additional accessories.

Coding	Order No.
KO BU/SU10.16HP / BV/SV7.62	<b>1824410000</b>
KO BU/SU10.16HP WT	<b>2592600000</b>
Screwdriver	
SDS 0.8X4.5X125	<b>9009020000</b>

**Ordering data**

Solder pin length				
Colour	Black			
Pitch	10.16 mm			
Pol.	L1	(inch)	Qty.	Order No.
2	20.32	0.800	36	<b>2493230000</b>
3	30.48	1.200	28	<b>2493240000</b>
4	40.64	1.600	24	<b>2493260000</b>
5	50.80	2.000	50	<b>2586730000</b>
6	60.96	2.400	50	<b>2586820000</b>

**Representative deratings curve**

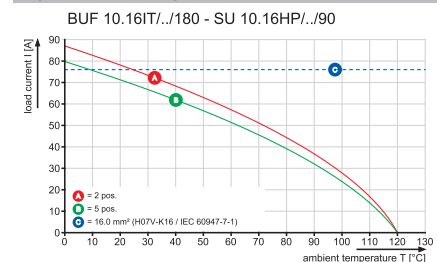

BUF 10.16IT../180MSF3



Dimensioned drawing

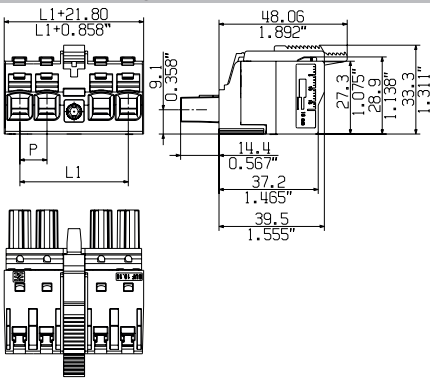

Ordering data

Solder pin length					
Colour					Black
Pitch 10.16 mm					
Pol.	L1	(inch)	Qty.	Order No.	
3	30.48	1.200	28	2493250000	
4	40.64	1.600	24	2493270000	
5	50.80	2.000	50	2586740000	
6	60.96	2.400	50	2586830000	

BUF 10.16IT../180MSF4



Dimensioned drawing

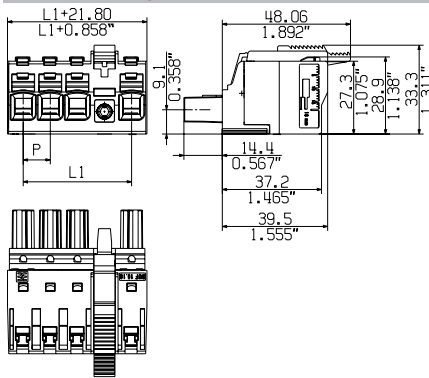

Ordering data

Solder pin length					
Colour					Black
Pitch 10.16 mm					
Pol.	L1	(inch)	Qty.	Order No.	
4	40.64	1.600	24	2493280000	
5	50.80	2.000	50	2586750000	
6	60.96	2.400	50	2586840000	

Additional deratings curves

BUF 10.16IT../180 - SU 10.16HP../90

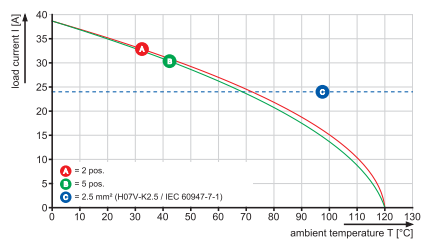

## OMNIMATE® Power BL/SL 7.62HP – power class up to 2.55 mm<sup>2</sup> and 24 A

### Custom-fit solutions for compact devices

**Compact power for more safety and efficiency: The compact class in the OMNIMATE® Power BL/SL 7.62HP power connector series integrates previously-conflicting market requirements to provide a custom-fit solution for drive applications.**

This closes the gap between increasing miniaturisation and unlimited 600 V UL approval. The system extension to the 12 kVA power class enables a touch-safe, inverted motor connection with one-handed safety interlock. The "PUSH IN" connection system also provides a quick and reliable wire connection. Doublesided touch protection guarantees full protection even with inverse voltages. Thus even OMNIMATE® Power's compact class is qualified for use with the DC link bus.

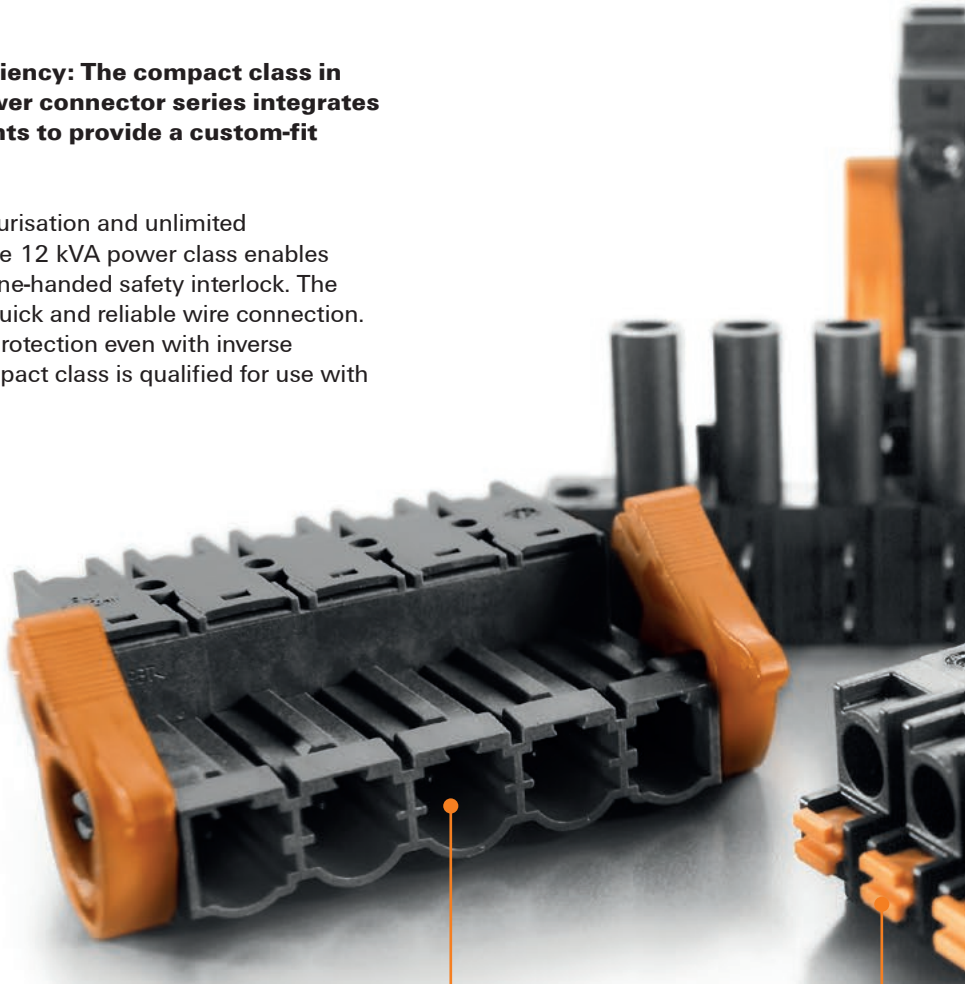

#### Compact safety

No additional measures required for DC links or inverse voltage: the inverted versions have finger-safe male header and female header even when not plugged in.

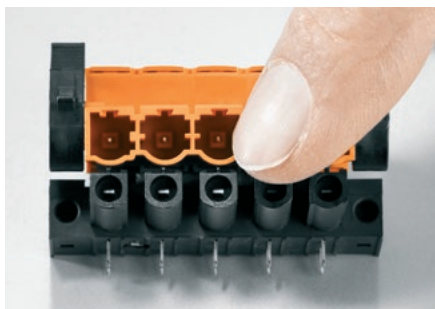

#### Compact reliability

Maintenance-free and vibration-proof connections: quick and simple "PUSH IN" connections, or the self-fastening Weidmüller steel clamp with plus/minus screw and "Wire Guard".



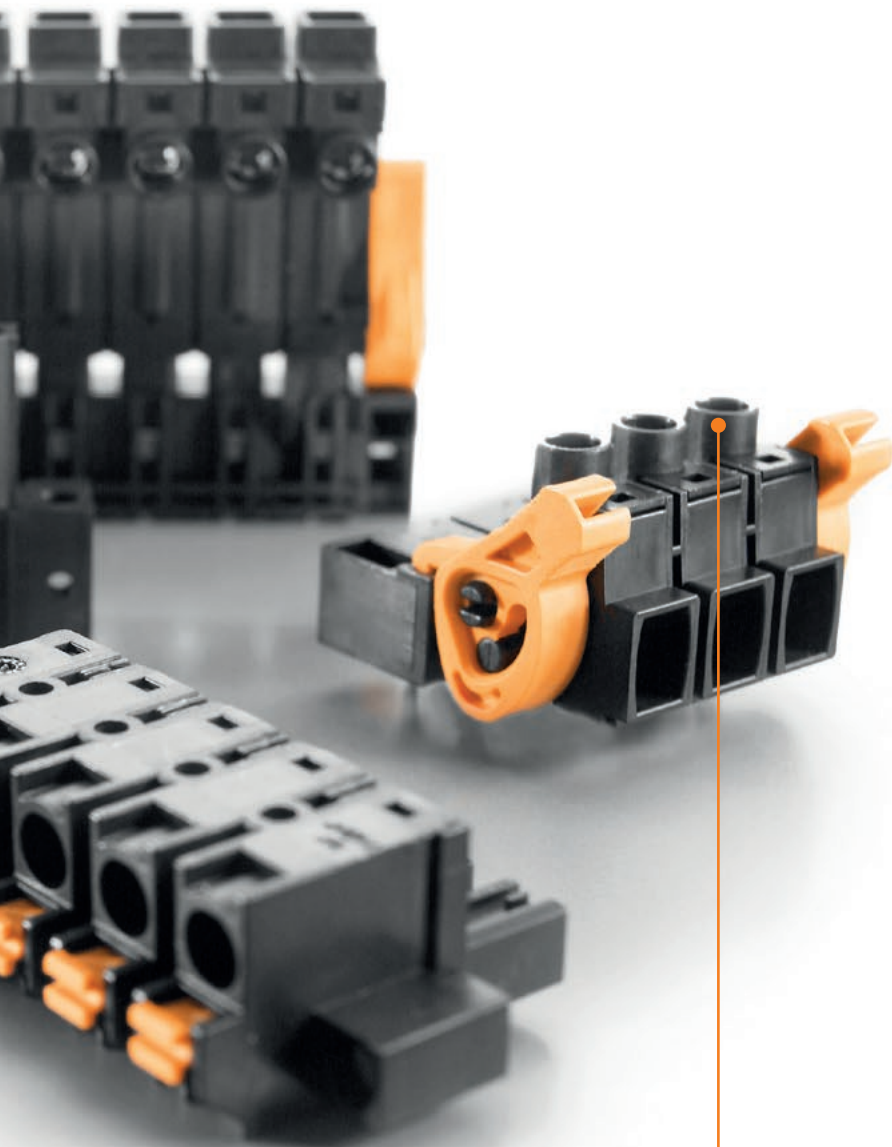

**Compact integration**

No compromises during design and approval: compact and standard-compliant with additional +3.0 mm finger safety, according to IEC 61800-5-1, and increased creepage and clearance distances according to UL.

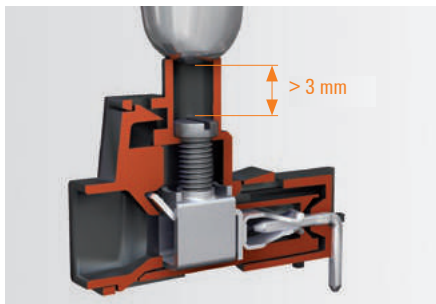

**Compact system power**

An overview of OMNIMATE® Power's 12 kVA class: The compact system with either standard or inverted mating profile, with screw or "PUSH IN" wire connection; optionally with lock & release lever, screw flange or one-handed safety interlock.

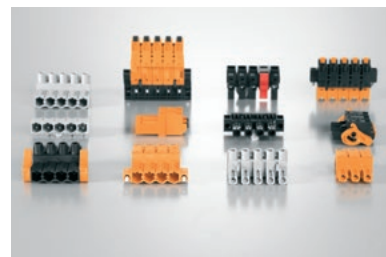

**Unrivalled current-carrying capacity**

The highest load capacity in the 12 kVA compact class: with up to 29 A current-carrying capacity at 1.000 V (IEC) with a 4 mm<sup>2</sup> wire cross-section or 18.5 A at 600 V according to UL.



**Individualised configuration**

Standard + Services = custom design with simple configuration across the entire range of services: features include colour coding, application-oriented labelling and custom modifications or design. More information can be found at <http://galaxy.weidmueller.com>



## Ergonomic operation and simple front design

### OMNIMATE® Power opens up new 270° perspectives

With modular devices, the PCBs are often perpendicular, i.e. located on the right and left, close to the housing wall. Hence the need to arrange the male header in the device so that it points to the middle.

To avoid the need to change the direction of access during installation, we have developed a 270° male header. The combination of two opposing PCBs inside the housing, one with a 90° and the other with a 270° pin header. This allows you to keep the screwdriver comfortably in your right hand when wiring.

In addition to the ergonomic operation without the need to change hands, the consistent alignment of the connections also means that the layout of the front panel is particularly simple and clear.

#### Your special advantages:

##### Compact and powerful

We offer you the smallest plug-in "PUSH IN" connection solution for field wiring up to 600 V UL with a connection cross-section of AWG 12 (2.5 mm<sup>2</sup>).



The solder flange solution for the pin connector on the PCB and the possible flange fixing of the plug section simplify the use of complex device applications with high mechanical demands

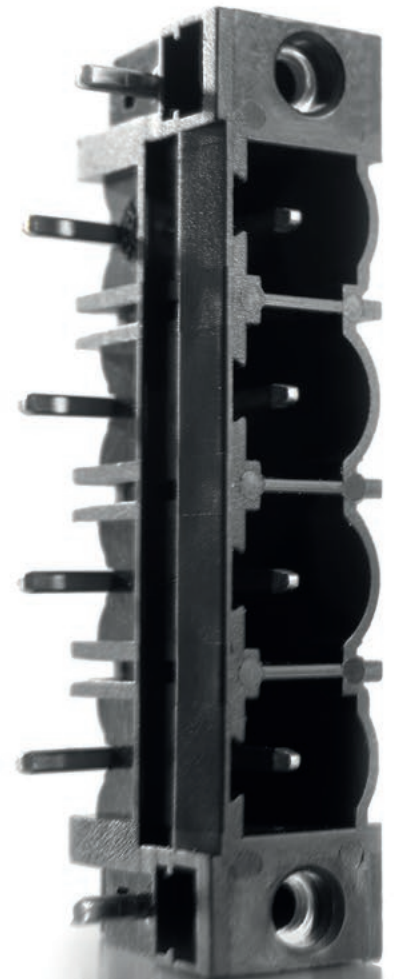

**Simple design, standard operation**

All "PUSH IN" connection components on the front panel are aligned in the same direction thanks to the 270° male header. This allows a continuous operation with the right hand.



**A strong team**

Especially in industrial applications in a vibration environment, the combination of female header BLF7.62HP for 600 V UL and male header SL7.62HP are convincing as a strong "PUSH IN" solution.



<http://www.OMNIMATE.net>

○ = Wire-to-Board  
 ● = Board-to-Board  
 ○ = Wire-to-Wire  
 ● = Board-to-Wire

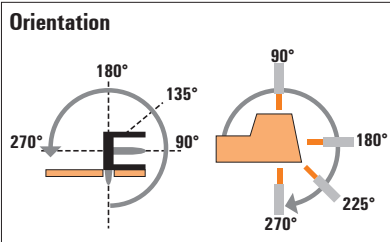

**Male header**

**Solder connection**



**BL/SL 7.62 series**





Type	SL	SL
Orientation	90°/270°	180°
Flange options	G/F/LF	G/F/LF
<b>Product code numbers</b>	IEC: 800 V/24 A UL: 300 V/20 A	IEC: 800 V/24 A UL: 300 V/20 A

Female plug	Female header	Product code numbers
 <b>Screw Clamping yoke</b>	 <b>Spring PUSH IN</b>	 <b>Solder connection</b>
 <b>BLZ</b> 180° (G)/LR IEC: 630 V/24 A/0.08 - 2.5 mm <sup>2</sup> UL: 600 V/20 A/AWG 20 - 12	 <b>BLF</b> 180° (G)/F/LR IEC: 1.000 V/24 A/0.08 - 2.5 mm <sup>2</sup> UL: 300 V/20 A/AWG 20	 <b>BLL</b> 90° (G)/F/LF IEC: 630 V/24 A UL: 300 V/20 A
	 <b>BLL</b> 180° (G)/F/LF IEC: 630 V/24 A UL: 300 V/20 A	

**Female plug and header:**  
 (G) = Closed (without flange)  
 F = Screw flange with screw  
 LR = Lock & Release lever

**Male header and plug:**  
 G = Closed (without flange)  
 F = Screw flange with nut  
 LF = Solder flange with nut  
 LR = Lock & Release lever



Male plug	
	
<b>Screw Clamping yoke</b>	<b>Spring PUSH IN</b>



	<b>SLZ</b>	<b>SLF</b>
	180°	180°
	G/F/LR	G/F/LR
	IEC: 1.000 V/24 A/ 0.08 - 2.5 mm <sup>2</sup> UL: 600 V/17 A/ AWG 20 - 12	IEC: 1.000 V/24 A/ 0.08 - 2.5 mm <sup>2</sup> UL: 600 V/20 A/ AWG 20 - 12
	●	●
	●	●



**Plug-in connector, pitch 7.62 mm**  
**BL/SL 7.62 series - connection up to 4 mm<sup>2</sup>**

**SL 7.62HP/./90**

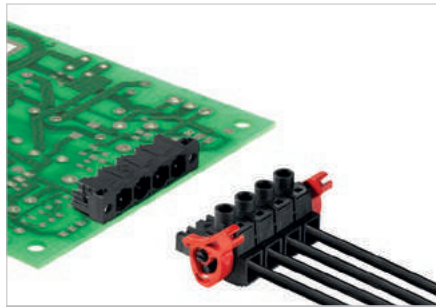

Male header with 90° outlet direction. The compact and efficient solution for UL-600 V applications in the lower power range in combination with a female plug fulfils the requirements for 600 V acc. to UL508 / UL840 and the enhanced electric shock protection requirements acc. to IEC 68100-5-1.

Variants: flange and solder flanges versions.

**Product data**

IEC: 630 V / 29 A  
 UL: 300 V / 20 A



For additional articles and information, refer to [catalog.weidmuller.com](http://catalog.weidmuller.com)

**Note:**

- Additional colours on request
- Gold-plated contact surfaces on request
- Rated current related to rated cross-section & min. No. of poles.
- P on drawing = pitch
- Rated data refer only to the component itself. Clearance and creepage distances to other components are to be designed in accordance with the relevant application standards.

**SL 7.62HP/./90G**



**Dimensioned drawing**

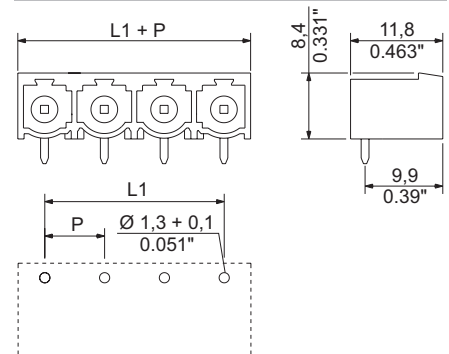

**Technical data**

**In compliance with IEC 60664-1 / IEC 61984**

Clamping range, max.			
<b>Solid core H05(07) V-U</b>			
Stranded H07 V-R			
Flexible H05(07) V-K			
Flexible with ferrule			
Ferrule with plastic collar			
Stripping length			
Screwdriver blade	mm		
According to norm			
Tightening torque range			
<b>Rated current, max.</b>	<b>A</b>	<b>29</b>	<b>25</b>
At ambient temperature		20°C	40°C
For conductor cross-section			
Overtoltage category		III	III II
Pollution severity		3	2 2
<b>Rated voltage</b>	<b>V</b>	<b>400</b>	<b>500 630</b>
Rated impulse voltage	kV	6	6 6
<b>UL / CUL (Use Group)</b>		<b>B</b>	<b>C D</b>
<b>Rated voltage</b>	<b>V</b>	<b>300</b>	<b>300 600</b>
<b>Rated current</b>	<b>A</b>	<b>20</b>	<b>20 5</b>
<b>AWG conductor</b>	<b>AWG</b>		<b>-</b>
<b>CSA (Use Group)</b>		<b>B</b>	<b>C D</b>
Rated voltage	V	300	300 600
Rated current	A	20	20 5
AWG conductor	AWG		-
<b>General data</b>			
Type of insulation material		PBT	
UL 94 flammability rating		V-0	
Contact base material		Copper alloy	
Material of contact surface		tinned	
Pin dimensions = d	mm	1.0 x 1.0	
Solder eyelet Ø = D	mm	1.3	
Solder eyelet Ø tolerance	mm	+ 0,1	

**Accessories**

**Note:** Refer to the Accessories chapter for additional accessories.

Coding	Order No.
BLZ/SL KO OR BX	1573010000
BLZ/SL KO BK BX	1545710000

**Ordering data**

Solder pin length		3.2 mm		
Colour		Black		
Pitch		7.62 mm		
Pol.	L1	(inch)	Qty.	Order No.
2	7.62	0.300	100	1026760000
3	15.24	0.600	100	1026770000
4	22.86	0.900	100	1026780000
5	30.48	1.200	50	1026790000
6	38.10	1.500	50	1059490000
7	45.72	1.800	50	1059500000
8	53.34	2.100	50	1059510000
9	60.96	2.400	50	1059520000
10	68.58	2.700	50	1059530000
11	76.20	3.000	50	1059550000
12	83.82	3.300	50	1059570000

SL 7.62HP/./90F



Dimensioned drawing

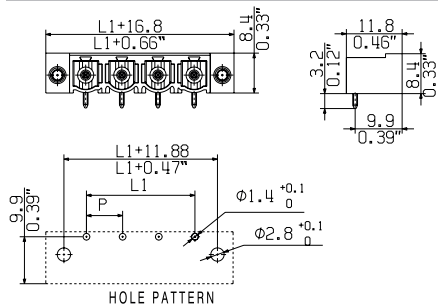

SL 7.62HP/./90LF



Dimensioned drawing

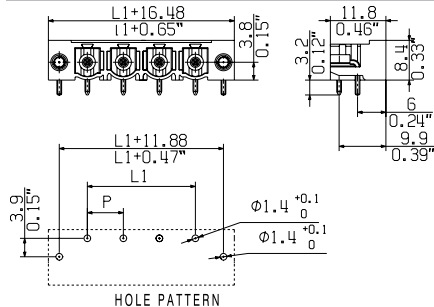

Ordering data

Solder pin length		3.2 mm	
Colour		Black	
Pitch		7.62 mm	
Pol.	L1	(inch)	Order No.
2	7.62	0.300	1026850000
3	15.24	0.600	1026860000
4	22.86	0.900	1026870000
5	30.48	1.200	1026880000
6	38.10	1.500	1124250000
7	45.72	1.800	1124270000
8	53.34	2.100	1124280000
9	60.96	2.400	1124290000
10	68.58	2.700	1124300000
11	76.20	3.000	1124310000
12	83.82	3.300	1124320000

Ordering data

Solder pin length		3.2 mm	
Colour		Black	
Pitch		7.62 mm	
Pol.	L1	(inch)	Order No.
2	7.62	0.300	1095920000
3	15.24	0.600	1095930000
4	22.86	0.900	1095940000
5	30.48	1.200	1095950000
6	38.10	1.500	1095960000
7	45.72	1.800	1095970000
8	53.34	2.100	1095980000
9	60.96	2.400	1095990000
10	68.58	2.700	1096000000
11	76.20	3.000	1096010000
12	83.82	3.300	1096020000

**Plug-in connector, pitch 7.62 mm**  
**BL/SL 7.62 series - connection up to 4 mm<sup>2</sup>**

**SL 7.62HP/./180**

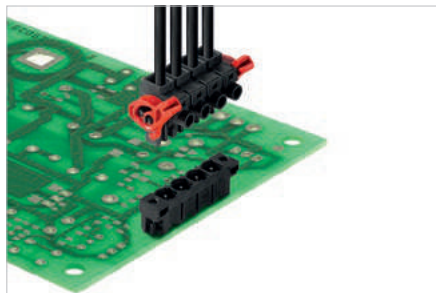

Male header with 180° outlet direction. The compact and efficient solution for UL-600 V applications in the lower power range fulfils, in combination with a female plug, the requirements for 600 V in acc. with UL508-5-1 / UL840 and the enhanced electric shock protection requirements in acc. with IEC 68100-5-1.

Variants: flanges and solder flange versions.

**Product data**

IEC: 630 V / 29 A  
 UL: 300 V / 20 A



For additional articles and information, refer to [catalog.weidmuller.com](http://catalog.weidmuller.com)

**Note:**

- Additional colours on request
- Gold-plated contact surfaces on request
- Rated current related to rated cross-section & min. No. of poles.
- P on drawing = pitch
- Rated data refer only to the component itself. Clearance and creepage distances to other components are to be designed in accordance with the relevant application standards.

**SL 7.62HP/./180G**



**Dimensioned drawing**

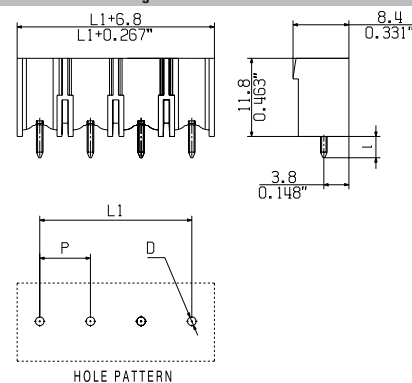

**Technical data**

**In compliance with IEC 60664-1 / IEC 61984**

Clamping range, max.			
<b>Solid core H05(07) V-U</b>			
Stranded H07 V-R			
Flexible H05(07) V-K			
Flexible with ferrule			
Ferrule with plastic collar			
Stripping length			
Screwdriver blade	mm		
According to norm			
Tightening torque range			
<b>Rated current, max.</b>	<b>A</b>	<b>29</b>	<b>25</b>
At ambient temperature		20°C	40°C
For conductor cross-section			
Overtoltage category		III	III II
Pollution severity		3	2 2
<b>Rated voltage</b>	<b>V</b>	<b>400</b>	<b>500 630</b>
Rated impulse voltage	kV	6	6 6
<b>UL / CUL (Use Group)</b>	<b>B C D</b>		
<b>Rated voltage</b>	<b>V</b>	<b>300</b>	<b>300 600</b>
<b>Rated current</b>	<b>A</b>	<b>20</b>	<b>20 5</b>
<b>AWG conductor</b>	<b>AWG</b>	-	
<b>CSA (Use Group)</b>	<b>B C D</b>		
Rated voltage	V	300	300 600
Rated current	A	20	20 5
AWG conductor	AWG	-	
<b>General data</b>			
Type of insulation material		PBT	
UL 94 flammability rating		V-0	
Contact base material		Copper alloy	
Material of contact surface		tinned	
Pin dimensions = d	mm	1.0 x 1.0	
Solder eyelet Ø = D	mm	1.3	
Solder eyelet Ø tolerance	mm	+ 0,1	

**Accessories**

**Note:** Refer to the Accessories chapter for additional accessories.

Coding	Order No.
BLZ/SL KO OR BX	1573010000
BLZ/SL KO BK BX	1545710000

**Ordering data**

Solder pin length		3.2 mm		
Colour		Black		
Pitch		7.62 mm		
Pol.	L1	(inch)	Qty.	Order No.
2	7.62	0.300	100	1122550000
3	15.24	0.600	100	1122570000
4	22.86	0.900	100	1122580000
5	30.48	1.200	50	1048980000
6	38.10	1.500	50	1048990000
7	45.72	1.800	50	1122590000
8	53.34	2.100	50	1049000000
9	60.96	2.400	50	1122600000
10	68.58	2.700	50	1122610000
11	76.20	3.000	50	1122640000
12	83.82	3.300	50	1122650000

SL 7.62HP../180F



Dimensioned drawing

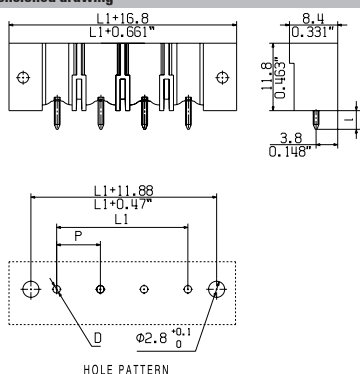

Ordering data

Solder pin length		3.2 mm			
Colour		Black			
Pitch		7.62 mm			
Pol.	L1	(inch)	Qty.	Order No.	
2	7.62	0.300	100	1140870000	
3	15.24	0.600	100	1140880000	
4	22.86	0.900	100	1140890000	
5	30.48	1.200	50	1140900000	
6	38.10	1.500	50	1140910000	
7	45.72	1.800	50	1140920000	
8	53.34	2.100	50	1140930000	
9	60.96	2.400	50	1140940000	
10	68.58	2.700	50	1140950000	
11	76.20	3.000	50	1140960000	
12	83.82	3.300	50	1140970000	

SL 7.62HP../180LF



Dimensioned drawing

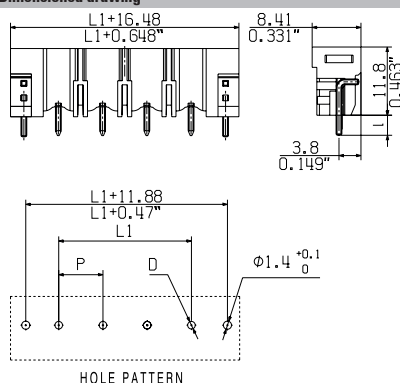

Ordering data

Solder pin length		3.2 mm			
Colour		Black			
Pitch		7.62 mm			
Pol.	L1	(inch)	Qty.	Order No.	
2	7.62	0.300	100	1141090000	
3	15.24	0.600	100	1141100000	
4	22.86	0.900	100	1141110000	
5	30.48	1.200	50	1141120000	
6	38.10	1.500	50	1141130000	
7	45.72	1.800	50	1141140000	
8	53.34	2.100	50	1141150000	
9	60.96	2.400	50	1141160000	
10	68.58	2.700	50	1141170000	
11	76.20	3.000	50	1141180000	
12	83.82	3.300	50	1141190000	



Plug-in connector, pitch 7.62 mm  
BL/SL 7.62 series - connection up to 4 mm<sup>2</sup>

SL 7.62HP/././270

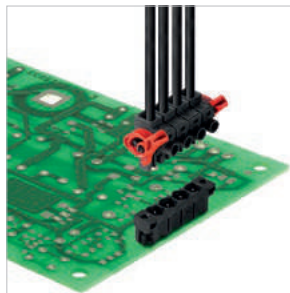

Pin header with 270° outlet direction. This compact solution for UL-600 V applications in the lower performance range meets the requirements for 600 V in accordance with UL 508 / UL 840 as well as the more stringent touch-safety requirements of IEC 68100-5-1 for electrical drive systems when combined with a female plug.

Variants: solder flange versions.

Product data

IEC: 630 V / 27.5 A  
UL: 300 V / 20 A



For additional articles and information, refer to [catalog.weidmueller.com](http://catalog.weidmueller.com)

Note:

- Additional colours on request
- Gold-plated contact surfaces on request
- Rated current related to rated cross-section & min. No. of poles.
- P on drawing = pitch
- Rated data refer only to the component itself. Clearance and creepage distances to other components are to be designed in accordance with the relevant application standards.

SL 7.62HP/270G



Dimensioned drawing

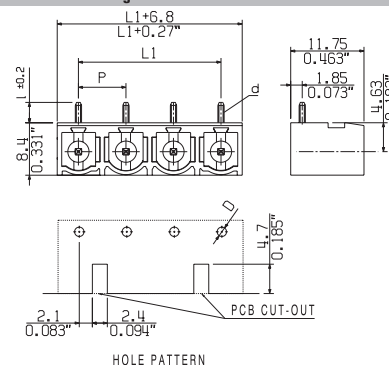

Technical data

In compliance with IEC 60664-1 / IEC 61984

Clamping range, max.			
<b>Solid core H05(07) V-U</b>			
Stranded H07 V-R			
Flexible H05(07) V-K			
Flexible with ferrule			
Ferrule with plastic collar			
Stripping length			
Screwdriver blade	mm		
According to norm			
Tightening torque range			
<b>Rated current, max.</b>	<b>A</b>	<b>27.5</b>	<b>25</b>
At ambient temperature		20°C	40°C
For conductor cross-section			
Overtolerance category		III	III
Pollution severity		3	2
<b>Rated voltage</b>	<b>V</b>	<b>400</b>	<b>500</b>
Rated impulse voltage	kV	4	6
<b>UL / CUL (Use Group)</b>	<b>B</b>	<b>C</b>	<b>D</b>
<b>Rated voltage</b>	<b>V</b>	<b>300</b>	<b>300</b>
<b>Rated current</b>	<b>A</b>	<b>20</b>	<b>20</b>
<b>AWG conductor</b>	<b>AWG</b>	-	-
<b>CSA (Use Group)</b>	<b>B</b>	<b>C</b>	<b>D</b>
Rated voltage	V	300	300
Rated current	A	20	20
AWG conductor	AWG	-	-
<b>General data</b>			
Type of insulation material		PA GF	
UL 94 flammability rating		V-0	
Contact base material		Copper alloy	
Material of contact surface			
Pin dimensions = d	mm	1.0 x 1.0	
Solder eyelet Ø = D	mm	1.3	
Solder eyelet Ø tolerance	mm	+ 0,1	

Accessories

Note: Refer to the Accessories chapter for additional accessories.

Coding	Order No.
BLZ/SL KO OR BX	1573010000
BLZ/SL KO BK BX	1545710000

Ordering data

Solder pin length		3.2 mm		
Colour		Black		
Pitch		7.62 mm		
Pol.	L1	(inch)	Qty.	Order No.
2	7.62	0.300	100	1472240000
3	15.24	0.600	100	1472250000
4	22.86	0.900	100	1472260000
5	30.48	1.200	50	1472270000
6	38.10	1.500	50	1472280000
7	45.72	1.800	50	1472290000
8	53.34	2.100	50	1472310000
9	60.96	2.400	50	1472320000
10	68.58	2.700	50	1472330000
11	76.20	3.000	50	1472340000
12	83.82	3.300	50	1472350000

K

7.62

270°

SL 7.62HP/270LF



Dimensioned drawing

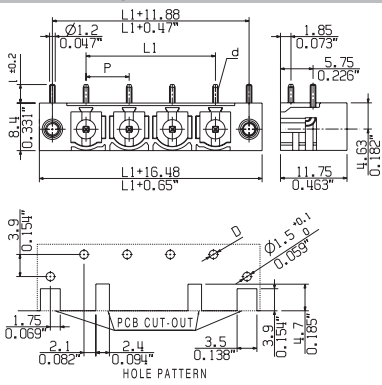

Ordering data

Solder pin length		3.2 mm		
Colour		Black		
Pitch		7.62 mm		
Pol.	L1	(inch)	Qty.	Order No.
2	7.62	0.300	100	1472360000
3	15.24	0.600	100	1472370000
4	22.86	0.900	100	1472380000
5	30.48	1.200	50	1472390000
6	38.10	1.500	50	1472410000
7	45.72	1.800	50	1472420000
8	53.34	2.100	50	1472430000
9	60.96	2.400	50	1472440000
10	68.58	2.700	50	1472450000
11	76.20	3.000	50	1472460000
12	83.82	3.300	50	1472470000



**Plug-in connector, pitch 7.62 mm**  
**BL/SL 7.62 series - connection up to 4 mm<sup>2</sup>**

**SLZ 7.62HP../180**

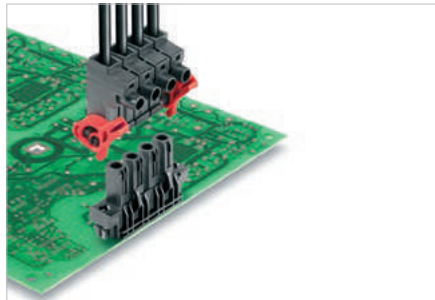

Male plug with clamping yoke screw connection in 180° outlet direction. Also perfect for finger-safe solutions involving inverse voltages. Complies with UL1059 600 V Use Group C and IEC 61800-5-1 requirements for 3 mm of finger safety on 400 V TNC(S) systems.

- Available with screw flange (F) and lock and release-levers (LR).

**Technical data**

In compliance with IEC 60664-1 / IEC 61984			
Clamping range, max.	mm <sup>2</sup>	0.08...2.5	
<b>Solid core H05(07) V-U</b>	<b>mm<sup>2</sup></b>	<b>0.5...2.5</b>	
Stranded H07 V-R			
Flexible H05(07) V-K	mm <sup>2</sup>	0.5...2.5	
Flexible with ferrule	mm <sup>2</sup>	0.5...2.5	
Ferrule with plastic collar	mm <sup>2</sup>	0.5...1.5	
Stripping length	mm	8	
Screwdriver blade	mm	0.6 x 3.5	
According to norm		DIN 5264	
Tightening torque range	Nm	0.4...0.5	
<b>Rated current, max.</b>	<b>A</b>	<b>20</b>	<b>17.5</b>
At ambient temperature		20°C	40°C
For conductor cross-section	mm <sup>2</sup>	2.5	
Overvoltage category		III	III II
Pollution severity		3	2 2
<b>Rated voltage</b>	<b>V</b>	<b>630</b>	<b>1000 1000</b>
Rated impulse voltage	kV	6	8 6
<b>UL / CUL (Use Group)</b>		<b>B</b>	<b>C D</b>
<b>Rated voltage</b>	<b>V</b>	<b>600</b>	<b>600 600</b>
<b>Rated current</b>	<b>A</b>	<b>17</b>	<b>17 5</b>
<b>AWG conductor</b>	<b>AWG</b>	<b>20-12</b>	
<b>CSA (Use Group)</b>		<b>B</b>	<b>C D</b>
Rated voltage	V	600	600 600
Rated current	A	17	17 5
AWG conductor	AWG	20-12	
General data			
Type of insulation material		PBT	
UL 94 flammability rating		V-0	
Contact base material		Copper alloy	
Material of contact surface		tinned	
Pin dimensions = d	mm		
Solder eyelet Ø = D	mm		
Solder eyelet Ø tolerance	mm		

**Product data**

IEC: 1000 V / 20 A / 0.5 - 2.5 mm<sup>2</sup>  
 UL: 600 V / 17 A / AWG 20 - 12



For additional articles and information, refer to [catalog.weidmuller.com](http://catalog.weidmuller.com)

**Note:**

- Additional colours on request
- Gold-plated contact surfaces on request
- Rated current related to rated cross-section & min. No. of poles.
- Wire end ferrule without plastic collar to DIN 46228/1
- Wire end ferrule with plastic collar to DIN 46228/4
- P on drawing = pitch
- Rated data refer only to the component itself. Clearance and creepage distances to other components are to be designed in accordance with the relevant application standards.

**SLZ 7.62HP../180G**



**Dimensioned drawing**

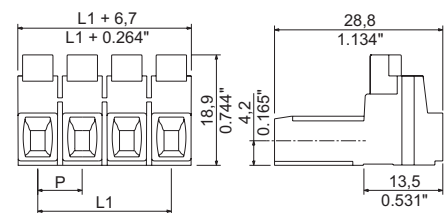

**Accessories**

**Note:** Refer to the Accessories chapter for additional accessories.

Screwdriver		Order No.
	SDS 0.6X3.5X100	<b>9008330000</b>
	SDIS 0.6X3.5X100	<b>9008390000</b>

**Ordering data**

Solder pin length					
Colour					Black
Pitch		7.62 mm			
Pol.	L1	(inch)	Qty.	Order No.	
2	7.62	0.300	126	<b>1043350000</b>	
3	15.24	0.600	84	<b>1043360000</b>	
4	22.86	0.900	60	<b>1043370000</b>	
5	30.48	1.200	48	<b>1043380000</b>	

**Representative deratings curve**

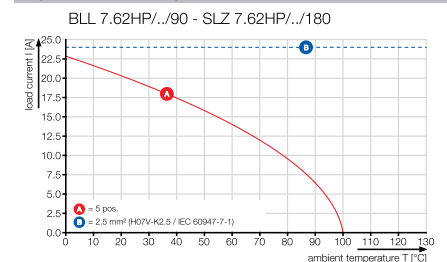



SLZ 7.62HP../180F



Dimensioned drawing

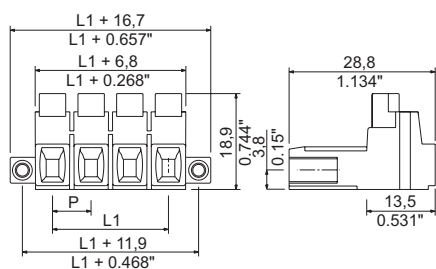

SLZ 7.62HP../180LR



Dimensioned drawing

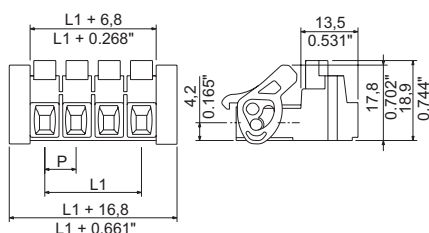

Ordering data

Solder pin length					
Colour					Black
Pitch 7.62 mm					
Pol.	L1	(inch)	Qty.	Order No.	
2	7.62	0.300	72	1043430000	
3	15.24	0.600	54	1043440000	
4	22.86	0.900	42	1043450000	
5	30.48	1.200	36	1043460000	

Ordering data

Solder pin length					
Colour					Black
Pitch 7.62 mm					
Pol.	L1	(inch)	Qty.	Order No.	
2	7.62	0.300	72	1043510000	
3	15.24	0.600	54	1043520000	
4	22.86	0.900	42	1043530000	
5	30.48	1.200	36	1043540000	

Additional deratings curves

BLL 7.62HP../90 - SLZ 7.62HP../180

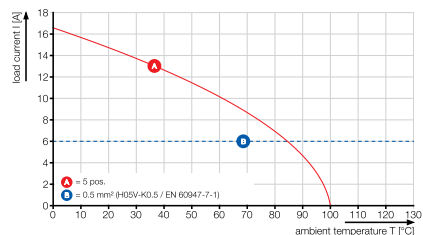

**Plug-in connector, pitch 7.62 mm**  
**BL/SL 7.62 series - connection up to 4 mm<sup>2</sup>**

**SLF 7.62HP../180**

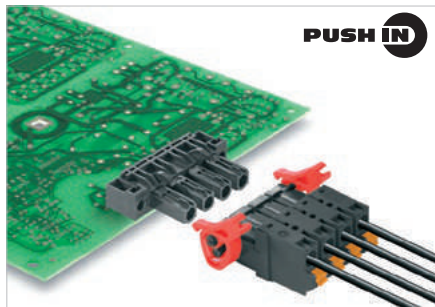

Male plug with "PUSH IN" spring connection in 180° outlet direction. Also perfect for finger-safe solutions involving inverse voltages. Complies with UL1059 600 V Use Group C and IEC 61800-5-1 requirements for 3 mm of finger safety on 400 V TNC systems.

- Available with screw flange (F) and lock and release-levers (LR).

**Technical data**

In compliance with IEC 60664-1 / IEC 61984			
Clamping range, max.	mm <sup>2</sup>	0.08...2.5	
<b>Solid core H05(07) V-U</b>	mm <sup>2</sup>	<b>0.5...2.5</b>	
Stranded H07 V-R			
Flexible H05(07) V-K	mm <sup>2</sup>	0.5...2.5	
Flexible with ferrule	mm <sup>2</sup>	0.5...1.5	
Ferrule with plastic collar	mm <sup>2</sup>	0.5...1.5	
Stripping length	mm	10	
Screwdriver blade	mm	0.6 x 3.5	
According to norm		DIN 5264	
Tightening torque range			
<b>Rated current, max.</b>	<b>A</b>	<b>24</b>	<b>23.8</b>
At ambient temperature		20°C	40°C
For conductor cross-section	mm <sup>2</sup>	2.5	
Overtoltage category		III	III II
Pollution severity		3	2 2
<b>Rated voltage</b>	<b>V</b>	<b>630</b>	<b>1000 1000</b>
Rated impulse voltage	kV	6	8 6
<b>UL / CUL (Use Group)</b>		<b>B</b>	<b>C D</b>
<b>Rated voltage</b>	<b>V</b>	<b>600</b>	<b>600 600</b>
<b>Rated current</b>	<b>A</b>	<b>20</b>	<b>20 5</b>
<b>AWG conductor</b>	<b>AWG</b>	<b>20-12</b>	
<b>CSA (Use Group)</b>		<b>B</b>	<b>C D</b>
Rated voltage	V	600	600 600
Rated current	A	20	20 5
AWG conductor	AWG	20-12	
<b>General data</b>			
Type of insulation material		PBT	
UL 94 flammability rating		V-0	
Contact base material		Copper alloy	
Material of contact surface		tinned	
Pin dimensions = d	mm		
Solder eyelet Ø = D	mm		
Solder eyelet Ø tolerance	mm		

**Product data**

IEC: 1000 V / 24 A / 0.5 - 2.5 mm<sup>2</sup>  
 UL: 600 V / 20 A / AWG 20 - 12



For additional articles and information, refer to [catalog.weidmuller.com](http://catalog.weidmuller.com)

**Note:**

- Additional colours on request
- Gold-plated contact surfaces on request
- Rated current related to rated cross-section & min. No. of poles.
- Wire end ferrule without plastic collar to DIN 46228/1
- Wire end ferrule with plastic collar to DIN 46228/4
- P on drawing = pitch
- Rated data refer only to the component itself. Clearance and creepage distances to other components are to be designed in accordance with the relevant application standards.

**SLF 7.62HP../180G**



**Dimensioned drawing**

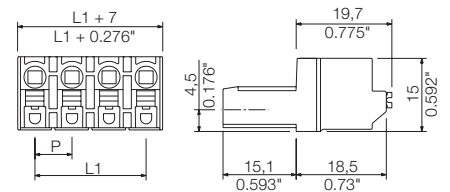

**Accessories**

**Note:** Refer to the Accessories chapter for additional accessories.

Screwdriver		Order No.
	SDS 0.6X3.5X100	<b>9008330000</b>
	SDIS 0.6X3.5X100	<b>9008390000</b>

**Ordering data**

Solder pin length					
Colour					Black
Pitch 7.62 mm					
Pol.	L1	(inch)	Qty.	Order No.	
2	7.62	0.300	126	<b>1043590000</b>	
3	15.24	0.600	84	<b>1043600000</b>	
4	22.86	0.900	60	<b>1043610000</b>	
5	30.48	1.200	48	<b>1043620000</b>	

**Representative deratings curve**

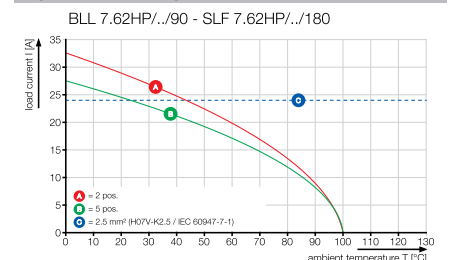

SLF 7.62HP../180F



Dimensioned drawing

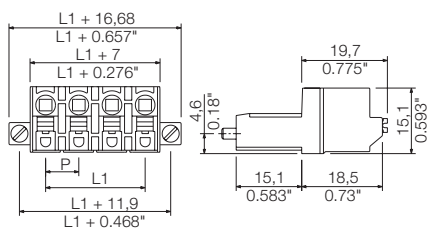

SLF 7.62HP../180LR



Dimensioned drawing

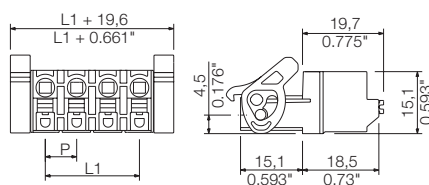

Ordering data

Solder pin length					
Colour					Black
Pitch 7.62 mm					
Pol.	L1	(inch)	Qty.	Order No.	
2	7.62	0.300	72	1043670000	
3	15.24	0.600	54	1043680000	
4	22.86	0.900	42	1043690000	
5	30.48	1.200	36	1043700000	

Ordering data

Solder pin length					
Colour					Black
Pitch 7.62 mm					
Pol.	L1	(inch)	Qty.	Order No.	
2	7.62	0.300	72	1043750000	
3	15.24	0.600	54	1043760000	
4	22.86	0.900	42	1043770000	
5	30.48	1.200	36	1043780000	



Additional deratings curves

BLL 7.62HP../90 - SLF 7.62HP../180

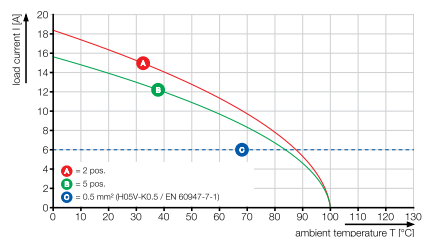

**Plug-in connector, pitch 7.62 mm**  
**BL/SL 7.62 series - connection up to 4 mm<sup>2</sup>**

**BLZ 7.62HP../180**

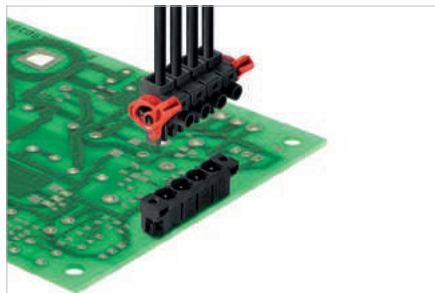

Female plug with clamping yoke screw connection in 180° outlet direction. Complies with UL1059 600 V Use Group C and IEC 61800-5-1 requirements for 3 mm of finger safety on 400 V TNC(S) systems.

- Available with lock and release-levers (LR) and screw flange on request.

**Technical data**

In compliance with IEC 60664-1 / IEC 61984			
Clamping range, max.	mm <sup>2</sup>	0.08...4	
<b>Solid core H05(07) V-U</b>	<b>mm<sup>2</sup></b>	<b>0.2...4</b>	
Stranded H07 V-R			
Flexible H05(07) V-K	mm <sup>2</sup>	0.2...4	
Flexible with ferrule	mm <sup>2</sup>	0.2...2.5	
Ferrule with plastic collar	mm <sup>2</sup>	0.2...2.5	
Stripping length	mm	7	
Screwdriver blade	mm	0.6 x 3.5	
According to norm		DIN 5264	
Tightening torque range	Nm	0.4...0.5	
<b>Rated current, max.</b>	<b>A</b>	<b>29</b>	<b>25</b>
At ambient temperature	20°C	40°C	
For conductor cross-section	mm <sup>2</sup>	2.5	
Overtoltage category		III	III II
Pollution severity		3	2 2
<b>Rated voltage</b>	<b>V</b>	<b>400</b>	<b>500 630</b>
Rated impulse voltage	kV	6	6 4
<b>UL / CUL (Use Group)</b>	<b>B C D</b>	<b>B</b>	<b>C D</b>
<b>Rated voltage</b>	<b>V</b>	<b>600</b>	<b>600 600</b>
<b>Rated current</b>	<b>A</b>	<b>20</b>	<b>20 5</b>
<b>AWG conductor</b>	<b>AWG</b>	<b>20-12</b>	
<b>CSA (Use Group)</b>	<b>B C D</b>	<b>B</b>	<b>C D</b>
Rated voltage	V	600	600 600
Rated current	A	20	20 5
AWG conductor	AWG	20-12	
General data			
Type of insulation material		PBT	
UL 94 flammability rating		V-0	
Contact base material		Copper alloy	
Material of contact surface		tinned	
Pin dimensions = d	mm		
Solder eyelet Ø = D	mm		
Solder eyelet Ø tolerance	mm		

**Product data**

IEC: 630 V / 29 A / 0.2 - 4 mm<sup>2</sup>  
 UL: 600 V / 20 A / AWG 20 - 12



For additional articles and information, refer to [catalog.weidmuller.com](http://catalog.weidmuller.com)

**Note:**

- Additional colours on request
- Gold-plated contact surfaces on request
- Rated current related to rated cross-section & min. No. of poles.
- Wire end ferrule without plastic collar to DIN 46228/1
- Wire end ferrule with plastic collar to DIN 46228/4
- P on drawing = pitch
- Rated data refer only to the component itself. Clearance and creepage distances to other components are to be designed in accordance with the relevant application standards.

**BLZ 7.62HP../180**



**Dimensioned drawing**

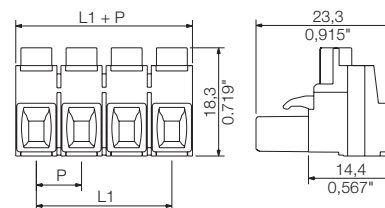

**Ordering data**

Solder pin length				
Colour				Black
Pitch 7.62 mm				
Pol.	L1	(inch)	Qty.	Order No.
2	7.62	0.300	100	1059580000
3	15.24	0.600	100	1059590000
4	22.86	0.900	100	1059600000
5	30.48	1.200	50	1049010000
6	38.10	1.500	50	1049020000
7	45.72	1.800	50	1059610000
8	53.34	2.100	50	1049030000
9	60.96	2.400	50	1059620000
10	68.58	2.700	50	1059630000
11	76.20	3.000	50	1059640000
12	83.82	3.300	50	1059670000

**Accessories**

**Note:** Refer to the Accessories chapter for additional accessories.

Coding	Order No.
BLZ/SL KO OR BX	1573010000
BLZ/SL KO BK BX	1545710000
Screwdriver	
SDS 0.6X3.5X100	9008330000
SDIS 0.6X3.5X100	9008390000

**Representative deratings curve**

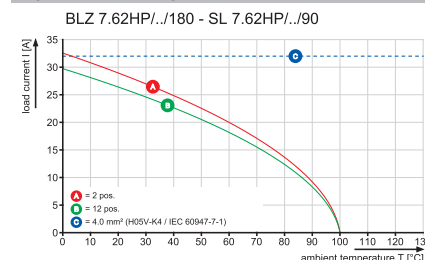

BLZ 7.62HP../180LR



Dimensioned drawing

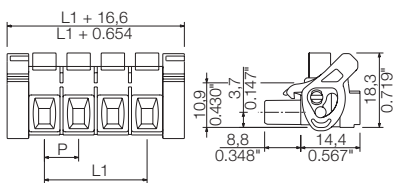

Ordering data

Solder pin length		Black		
Colour	Black			
Pitch	7.62 mm			
Pol.	L1	(inch)	Qty.	Order No.
2	7.62	0.300	60	1093430000
3	15.24	0.600	45	1093440000
4	22.86	0.900	35	1093450000
5	30.48	1.200	30	1093460000
6	38.10	1.500	25	1164960000
7	45.72	1.800	20	1164970000
8	53.34	2.100	20	1164980000
9	60.96	2.400	15	1164990000
10	68.58	2.700	15	1165000000
11	76.20	3.000	15	1165010000
12	83.82	3.300	15	1165020000



Additional deratings curves

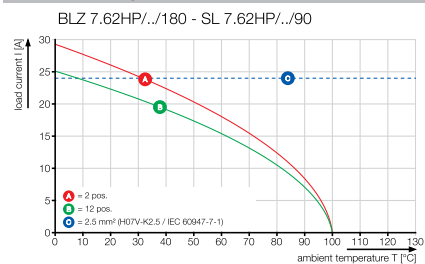

**Plug-in connector, pitch 7.62 mm**  
**BL/SL 7.62 series - connection up to 4 mm<sup>2</sup>**

**BLF 7.62HP../180**

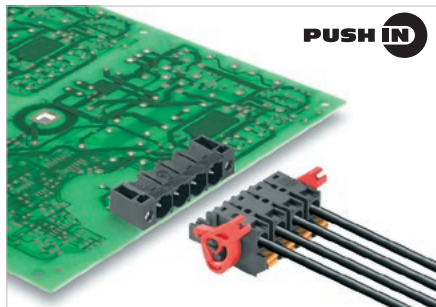

**PUSH IN**

Female plug with "PUSH IN" spring connection in 180 ° outlet direction. Complies with UL1059 600 V Use Group C and IEC 61800-5-1 requirements for 3 mm of finger safety on 400 V TNC(S) systems.

- Available with screw flange (F) and lock and release-levers (LR).

**Technical data**

In compliance with IEC 60664-1 / IEC 61984			
Clamping range, max.	mm <sup>2</sup>	0.08...2.5	
<b>Solid core H05(07) V-U</b>	mm <sup>2</sup>	<b>0.5...1.5</b>	
Stranded H07 V-R			
Flexible H05(07) V-K	mm <sup>2</sup>	0.5...2.5	
Flexible with ferrule	mm <sup>2</sup>	0.5...2.5	
Ferrule with plastic collar	mm <sup>2</sup>	0.5...2.5	
Stripping length	mm	10	
Screwdriver blade	mm	0.6 x 3.5	
According to norm			
Tightening torque range			
<b>Rated current, max.</b>	<b>A</b>	<b>24</b>	<b>23.8</b>
At ambient temperature		20°C	40°C
For conductor cross-section	mm <sup>2</sup>	2.5	
Overtoltage category		III	III II
Pollution severity		3	2 2
<b>Rated voltage</b>	<b>V</b>	<b>630</b>	<b>1000 1000</b>
Rated impulse voltage	kV	6	8 6
<b>UL / CUL (Use Group)</b>		<b>B</b>	<b>C D</b>
<b>Rated voltage</b>	<b>V</b>	<b>600</b>	<b>600 600</b>
<b>Rated current</b>	<b>A</b>	<b>20</b>	<b>20 5</b>
<b>AWG conductor</b>	<b>AWG</b>	<b>20-12</b>	
<b>CSA (Use Group)</b>		<b>B</b>	<b>C D</b>
Rated voltage	V	600	600 600
Rated current	A	21	21 5
AWG conductor	AWG	20-12	
General data			
Type of insulation material		PBT	
UL 94 flammability rating		V-0	
Contact base material		Copper alloy	
Material of contact surface		tinned	
Pin dimensions = d	mm		
Solder eyelet Ø = D	mm		
Solder eyelet Ø tolerance	mm		

**Product data**

IEC: 1000 V / 24 A / 0.5 - 2.5 mm<sup>2</sup>  
 UL: 600 V / 20 A / AWG 20 - 12



For additional articles and information, refer to [catalog.weidmuller.com](http://catalog.weidmuller.com)

**Note:**

- Additional colours on request
- Gold-plated contact surfaces on request
- Rated current related to rated cross-section & min. No. of poles.
- Wire end ferrule without plastic collar to DIN 46228/1
- Wire end ferrule with plastic collar to DIN 46228/4
- P on drawing = pitch
- Rated data refer only to the component itself. Clearance and creepage distances to other components are to be designed in accordance with the relevant application standards.

**BLF 7.62HP../180**

with test point



Dimensioned drawing

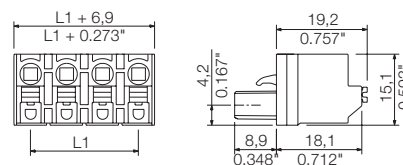

**Accessories**

**Note:** Refer to the Accessories chapter for additional accessories.

Screwdriver		Order No.
	SDS 0.5X3.0X80	<b>9008320000</b>
	SDIS 0.5X3.0X100	<b>9008380000</b>
Crimping tool		
	PZ 6/5	<b>9011460000</b>

**Ordering data**

Solder pin length				
Colour	Black			
Pitch	7.62 mm			
Pol.	L1	(inch)	Qty.	Order No.
2	7.62	0.300	120	<b>1043830000</b>
3	15.24	0.600	78	<b>1043840000</b>
4	22.86	0.900	60	<b>1043850000</b>
5	30.48	1.200	48	<b>1043860000</b>
6	38.10	1.500	36	<b>1227340000</b>
7	45.72	1.800	30	<b>1227350000</b>
8	53.34	2.100	30	<b>1227360000</b>
9	60.96	2.400	24	<b>1227370000</b>
10	68.58	2.700	24	<b>1227380000</b>
11	76.20	3.000	18	<b>1227390000</b>
12	83.82	3.300	18	<b>1227410000</b>

**Representative deratings curve**

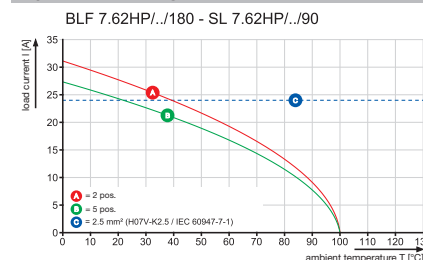

### BLF 7.62HP../180F

with test point



Dimensioned drawing

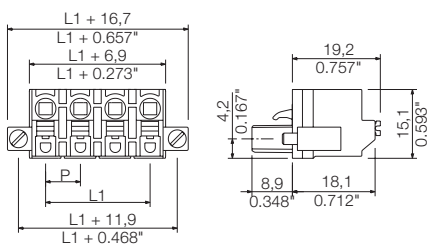

### BLF 7.62HP../180LR

with test point



Dimensioned drawing

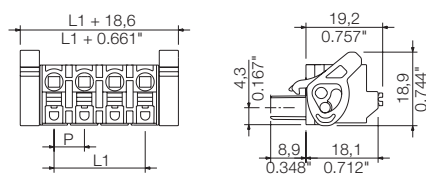

#### Ordering data

Solder pin length					
Colour					Black
Pitch 7.62 mm					
Pol.	L1	(inch)	Qty.	Order No.	
2	7.62	0.300	72	1043910000	
3	15.24	0.600	54	1043920000	
4	22.86	0.900	42	1043930000	
5	30.48	1.200	36	1043940000	
6	38.10	1.500	30	1227490000	
7	45.72	1.800	24	1227510000	
8	53.34	2.100	24	1227520000	
9	60.96	2.400	18	1227530000	
10	68.58	2.700	18	1227540000	

#### Ordering data

Solder pin length					
Colour					Black
Pitch 7.62 mm					
Pol.	L1	(inch)	Qty.	Order No.	
2	7.62	0.300	72	1043990000	
3	15.24	0.600	54	1044000000	
4	22.86	0.900	42	1044010000	
5	30.48	1.200	36	1044020000	
6	38.10	1.500	30	1227420000	
7	45.72	1.800	24	1227430000	
8	53.34	2.100	24	1227440000	
9	60.96	2.400	18	1227450000	
10	68.58	2.700	18	1227460000	



#### Additional deratings curves

BLF 7.62HP../180 - SL 7.62HP../90

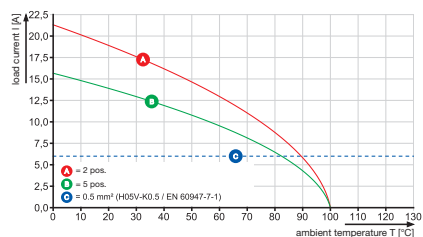

**Plug-in connector, pitch 7.62 mm**  
**BL/SL 7.62 series - connection up to 4 mm<sup>2</sup>**

**BLL 7.62HP../90**

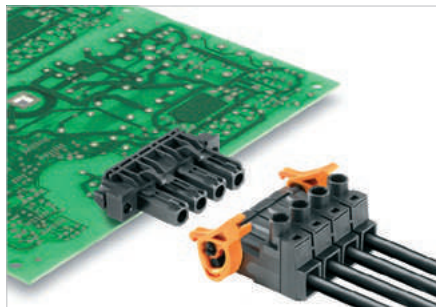

Touch-safe female header with 90° outlet direction for PCBs. Meets the requirements of IEC 61800-5-1 and comes with UL approval in accordance with UL508-5-1 / UL840 for 600 V. An ideal touch-safe solution for power output and DC-link applications. The pin arrangement ensures more than 3 mm of touch-safety in accordance with IEC 61800-5-1.

Variants: flange and solder flange fastening.

**Product data**

IEC: 630 V / 24 A  
 UL: 300 V / 20 A



For additional articles and information, refer to [catalog.weidmuller.com](http://catalog.weidmuller.com)

**Note:**

- Additional colours on request
- Gold-plated contact surfaces on request
- Spacing between rows: see hole layout
- Rated current related to rated cross-section & min. No. of poles.
- P on drawing = pitch
- Rated data refer only to the component itself. Clearance and creepage distances to other components are to be designed in accordance with the relevant application standards.

**BLL 7.62HP../90G**



**Dimensioned drawing**

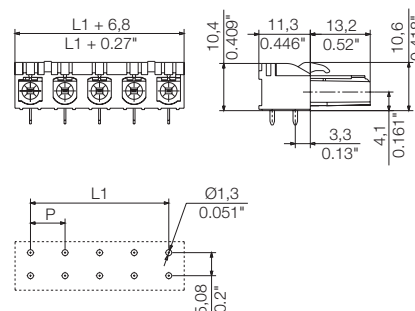

**Technical data**

**In compliance with IEC 60664-1 / IEC 61984**

Clamping range, max.			
<b>Solid core H05(07) V-U</b>			
Stranded H07 V-R			
Flexible H05(07) V-K			
Flexible with ferrule			
Ferrule with ferrule collar			
Stripping length			
Screwdriver blade	mm		
According to norm			
Tightening torque range			
<b>Rated current, max.</b>	<b>A</b>	<b>24</b>	<b>24</b>
At ambient temperature		20°C	40°C
For conductor cross-section			
Overvoltage category		III	III
Pollution severity		3	2
<b>Rated voltage</b>	<b>V</b>	<b>400</b>	<b>630</b>
Rated impulse voltage	kV	6	6
<b>UL / CUL (Use Group)</b>		<b>B</b>	<b>C</b>
<b>Rated voltage</b>	<b>V</b>	<b>300</b>	<b>150</b>
<b>Rated current</b>	<b>A</b>	<b>20</b>	<b>20</b>
<b>AWG conductor</b>	<b>AWG</b>	-	-
<b>CSA (Use Group)</b>		<b>B</b>	<b>C</b>
Rated voltage	V	300	150
Rated current	A	20	20
AWG conductor	AWG	-	-
<b>General data</b>			
Type of insulation material		PA GF	
UL 94 flammability rating		V-0	
Contact base material		Copper alloy	
Material of contact surface		tinned	
Pin dimensions = d	mm	0.4 x 1.00	
Solder eyelet Ø = D	mm	1.3	
Solder eyelet Ø tolerance	mm	+ 0,1	

**Accessories**

**Note:** Refer to the Accessories chapter for additional accessories.

**Ordering data**

<b>Solder pin length</b>	<b>3.2 mm</b>			
<b>Colour</b>	<b>Black</b>			
<b>Pitch</b>	<b>7.62 mm</b>			
<b>Pol.</b>	<b>L1</b>	<b>(inch)</b>	<b>Qty.</b>	<b>Order No.</b>
2	7.62	0.300	126	<b>1043230000</b>
3	15.24	0.600	84	<b>1043240000</b>
4	22.86	0.900	60	<b>1043250000</b>
5	30.48	1.200	48	<b>1043260000</b>

**Representative deratings curve**

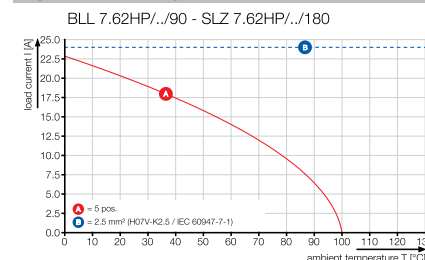



BLL 7.62HP../90F



Dimensioned drawing

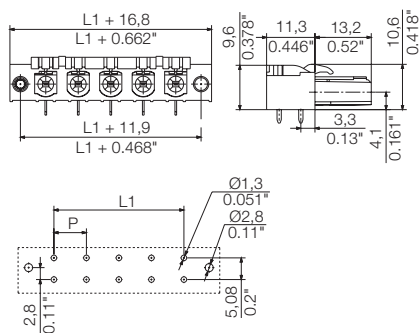

BLL 7.62HP../90LF



Dimensioned drawing

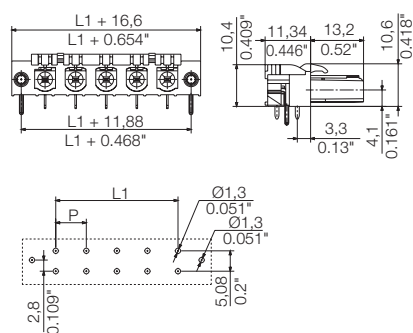

Ordering data

Solder pin length		3.2 mm		
Colour		Black		
Pitch		7.62 mm		
Pol.	L1	(inch)	Qty.	Order No.
2	7.62	0.300	72	1043270000
3	15.24	0.600	54	1043280000
4	22.86	0.900	42	1043290000
5	30.48	1.200	36	1043300000

Ordering data

Solder pin length		3.2 mm		
Colour		Black		
Pitch		7.62 mm		
Pol.	L1	(inch)	Qty.	Order No.
2	7.62	0.300	72	1095640000
3	15.24	0.600	54	1095650000
4	22.86	0.900	42	1095660000
5	30.48	1.200	36	1095670000



Additional deratings curves

BLL 7.62HP../90 - SLF 7.62HP../180

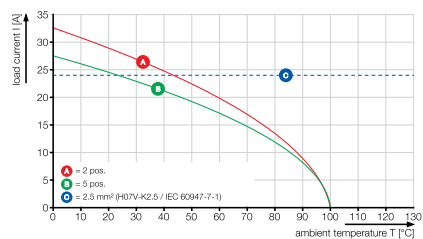

BLL 7.62HP../90 - SLZ 7.62HP../180

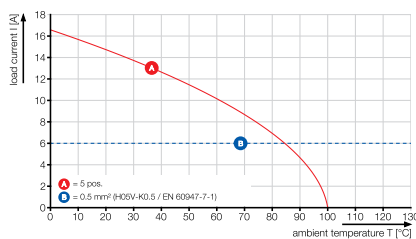

**Plug-in connector, pitch 7.62 mm**  
**BL/SL 7.62 series - connection up to 4 mm<sup>2</sup>**

**BLL 7.62HP../180**

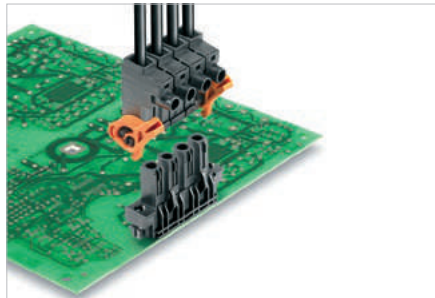

Touch-safe female header with 180° outlet direction for PCBs. Meets the requirements of IEC 61800-5-1 and comes with UL approval in accordance with UL508-5-1 / UL840 for 600 V. An ideal touch-safe solution for power output and DC-link applications. The pin arrangement ensures more than 3 mm of touch-safety in accordance with IEC 61800-5-1.

Variants: flange and solder flange fastening.

**Product data**

IEC: 630 V / 24 A  
 UL: 300 V / 20 A



For additional articles and information, refer to [catalog.weidmueller.com](http://catalog.weidmueller.com)

**Note:**

- Additional colours on request
- Gold-plated contact surfaces on request
- Spacing between rows: see hole layout
- Rated current related to rated cross-section & min. No. of poles.
- P on drawing = pitch
- Rated data refer only to the component itself. Clearance and creepage distances to other components are to be designed in accordance with the relevant application standards.

**BLL 7.62HP../180G**



**Dimensioned drawing**

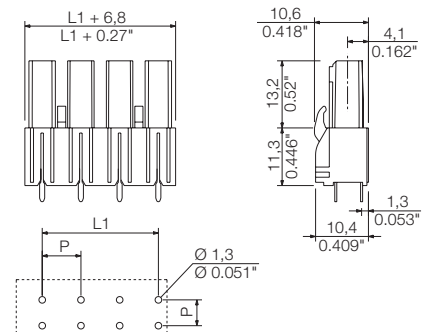

**Technical data**

**In compliance with IEC 60664-1 / IEC 61984**

Clamping range, max.			
<b>Solid core H05(07) V-U</b>			
Stranded H07 V-R			
Flexible H05(07) V-K			
Flexible with ferrule			
Ferrule with plastic collar			
Stripping length			
Screwdriver blade		mm	
According to norm			
Tightening torque range			
<b>Rated current, max.</b>	<b>A</b>	<b>24</b>	<b>24</b>
At ambient temperature		20°C	40°C
For conductor cross-section			
Overtoltage category		III	III II
Pollution severity		3	2 2
<b>Rated voltage</b>	<b>V</b>	<b>400</b>	<b>630 630</b>
Rated impulse voltage	kV	6	6 4
<b>UL / CUL (Use Group)</b>		<b>B</b>	<b>C D</b>
<b>Rated voltage</b>	<b>V</b>	<b>300</b>	<b>150 300</b>
<b>Rated current</b>	<b>A</b>	<b>20</b>	<b>20 10</b>
<b>AWG conductor</b>	<b>AWG</b>		<b>-</b>
<b>CSA (Use Group)</b>		<b>B</b>	<b>C D</b>
Rated voltage	V	300	150 300
Rated current	A	20	20 10
AWG conductor	AWG		-
<b>General data</b>			
Type of insulation material		PA GF	
UL 94 flammability rating		V-0	
Contact base material		Copper alloy	
Material of contact surface		tinned	
Pin dimensions = d	mm	0.4 x 1.00	
Solder eyelet Ø = D	mm	1.3	
Solder eyelet Ø tolerance	mm	+ 0,1	

**Accessories**

**Note:** Refer to the Accessories chapter for additional accessories.

**Ordering data**

<b>Solder pin length</b>	<b>3.2 mm</b>		
<b>Colour</b>	<b>Black</b>		
<b>Pitch</b>	<b>7.62 mm</b>		
<b>Pol.</b>	<b>L1</b>	<b>(inch)</b>	<b>Qty. Order No.</b>
2	7.62	0.300	126 <b>1122070000</b>
3	15.24	0.600	84 <b>1122080000</b>
4	22.86	0.900	60 <b>1122090000</b>
5	30.48	1.200	48 <b>1122100000</b>

**Representative deratings curve**

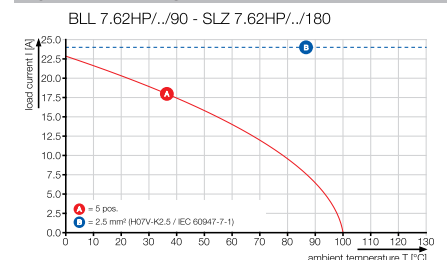

BLL 7.62HP../180F



Dimensioned drawing

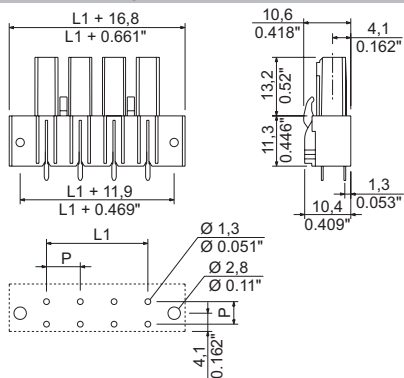

Ordering data

Solder pin length		3.2 mm		
Colour		Black		
Pitch		7.62 mm		
Pol.	L1	(inch)	Qty.	Order No.
2	7.62	0.300	72	1122110000
3	15.24	0.600	54	1122120000
4	22.86	0.900	42	1122130000
5	30.48	1.200	36	1122140000

BLL 7.62HP../180LF



Dimensioned drawing

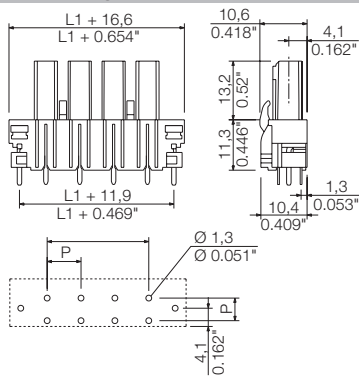

Ordering data

Solder pin length		3.2 mm		
Colour		Black		
Pitch		7.62 mm		
Pol.	L1	(inch)	Qty.	Order No.
2	7.62	0.300	72	1134080000
3	15.24	0.600	54	1134090000
4	22.86	0.900	42	1134110000
5	30.48	1.200	36	1134120000



Additional deratings curves

BLL 7.62HP../90 - SLF 7.62HP../180

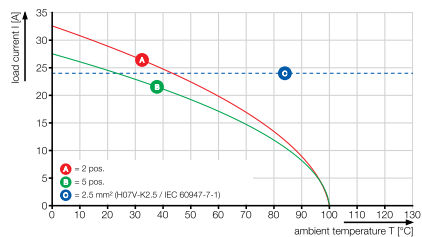

BLL 7.62HP../90 - SLZ 7.62HP../180

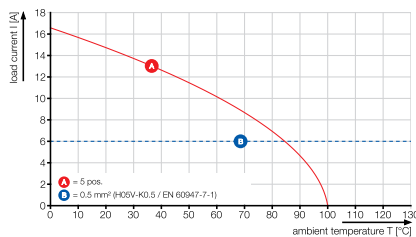

# OMNIMATE® Power BV/SV 7.62HP – power class from 6 mm<sup>2</sup> and 41 A

## Custom-fit high-powered solutions

**More power reserves for more load capacity: The OMNIMATE® Power SV / BV 7.62HP mid-level class of power connection systems is the top performer of the HP series. It features a large clamping range, increased overload capacity and the widest selection of variants and accessories.**

HP means High Performance – this performance covers a great deal: the full rated current up to 50 °C without derating, unlimited 600 V approval according to UL, and the additional finger safety for 400 V-TN systems (+ 3.0 mm) in compliance with the application directive IEC 61800-5-1.

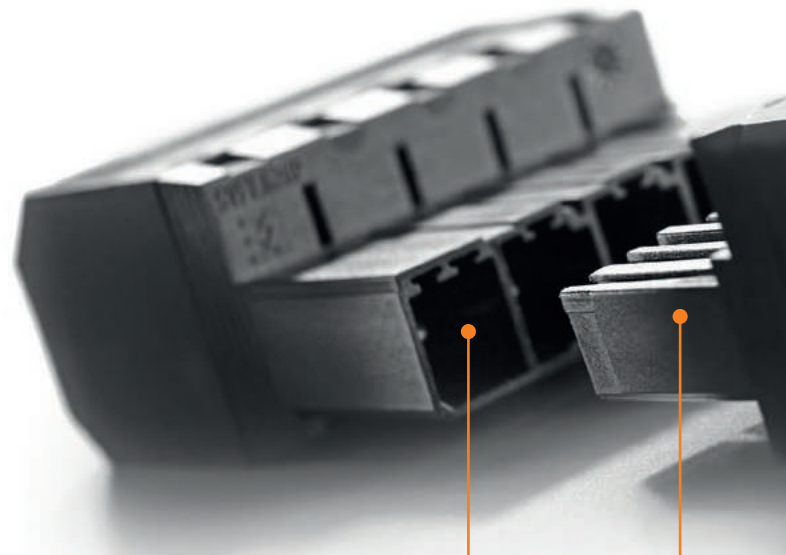

### Maximum safety

Safe for both man and machine with bi-directional finger safety: also when not plugged in and covering inverse voltages from power electronics.



### Maximum performance

Full current rating at 40 °C ambient temperature is a mandatory requirement in drive applications. What really makes the difference here is real-world, application-based overload and overheating capacities.

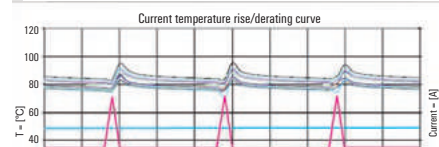
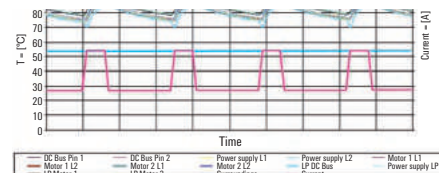

**Maximum user-friendliness**

Quick, simple plug and release: with the one-handed safety flange – convenient for the user and safe for the application.

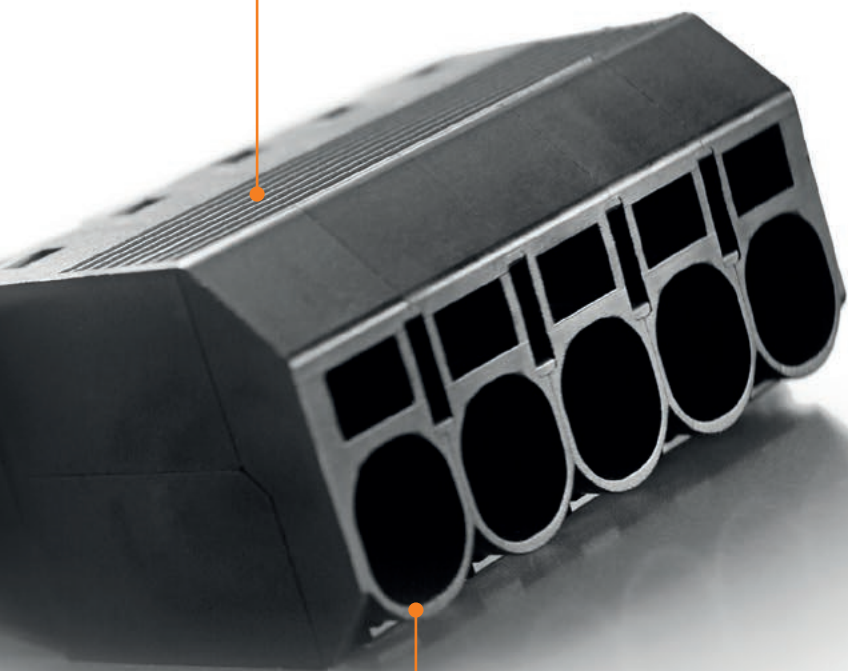
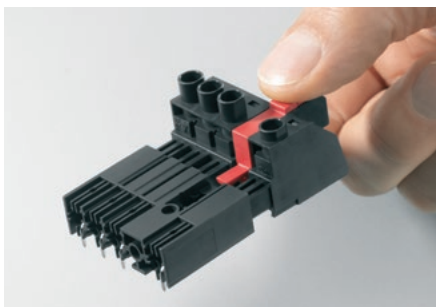

**Maximum efficiency**

Tool-free simplicity: quick PUSH IN connection mechanism and automatic, convenient snap-in with one-handed safety interlock.



**High system performance**

An overview of the 28-kVA class of OMNIMATE® Power: The HP system has been leading the way with its tool-free rapid interlock, installation-safe creepage and clearance distances, and application-based versioning scheme. This integrated strategy of system expansion includes a one-handed safety flange and wide range of innovative extras.

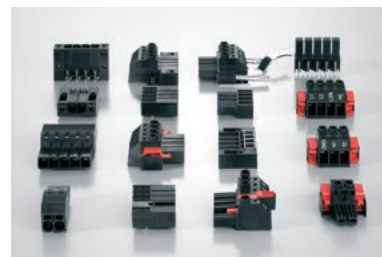

**Individualised configuration**

Standard + Services = custom design with simple configuration across the entire range of services: features include colour coding, application-oriented labelling and custom modifications or design.



## Convenient connection of stripped short wires OMNIMATE® Power with openable PUSH IN connection

Shielded cables for power electronics are stripped as short as possible for reasons of electromagnetic compatibility (EMC). Connection with large PUSH IN connectors is correspondingly complex. The same applies to cables with small cross-sections where often a “third hand” is missing or the use of special tools gets necessary.

Our BVFL 7.62HP simplifies and accelerates this process without the need of special tools. The combination of “PUSH IN” connection technology and a Pusher which can be locked in the open position allows an easy insertion of short stripped cables or of thin wires into the open terminal point. Subsequently, by pushing the pusher sideways with the hand, you can simply unlock the pusher.

The proven PUSH IN function remains unrestricted, while the in open position fixed terminal point allows a comfortable and easy connection under difficult conditions. Make use of the significant time savings to reduce your installation costs.

### Large PUSH IN connector, small wire cross-section

Even with ferrules, because of the high flexibility it is difficult to insert conductors with a low cross section into these connector. Our simple solution in three steps:

- 1) Open the terminal point
- 2) Insert conductors
- 3) Close the terminal point using sideways pressure

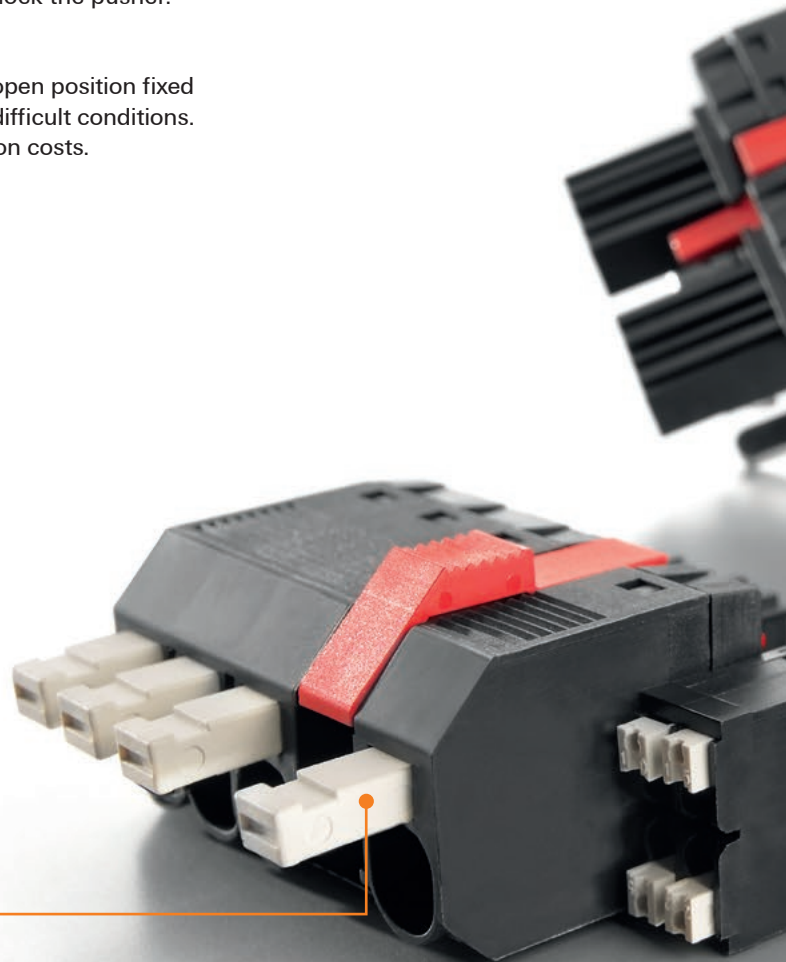

**Short-stripped wires**

The PUSH IN connector with a pusher in an open fixed position allows a quick and easy wiring without special tools. It also avoids the risk of a not fully inserted conductor.

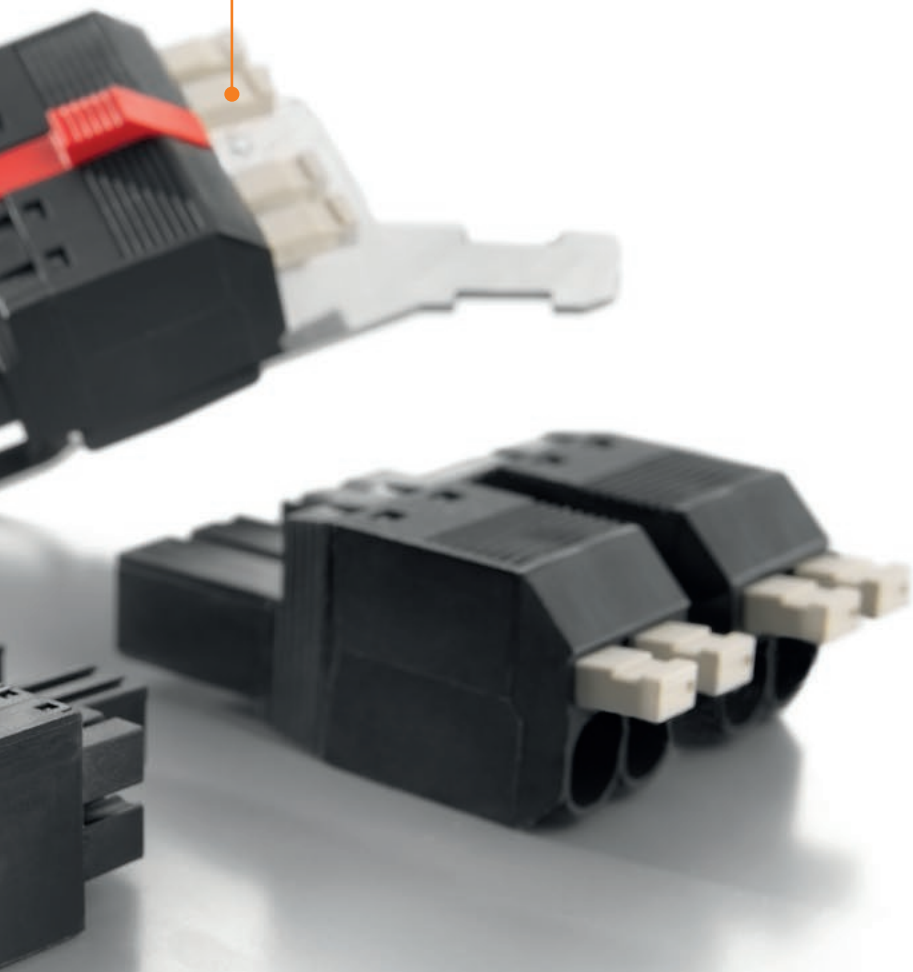
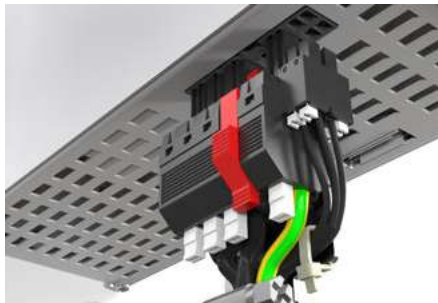

**Your special advantages:**

**More advantages in handling,  
reduced installation costs**

As the only PUSH IN connector so far available on the market, our BVFL 7.62HP has a special clamping point that can be locked in the open position.

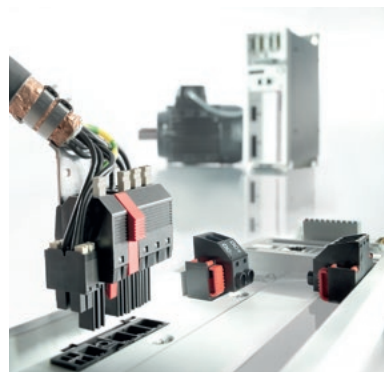

Work quickly while avoiding errors - convenient connectivity solutions with latchable open terminal point reduces the installation time in the field significantly for example in frequency inverters



## Implement complex supply solutions in the smallest of spaces OMNIMATE® Power – the compact, two-row connection solution

The demand for ever-smaller drive regulators with increasingly high performance ratings requires complex solutions in terms of the connection systems. The major challenge here is ensuring compliance with the existing standards.

The new double-level OMNIMATE® Power SVD 7.62HP male header minimises the amount of space required on the PCB, thereby creating space for other components. This extra space can be used for the integration of additional functions on the front of the device.

The two connection levels mean that the SVD 7.62HP can be used to implement complex solutions in extremely small spaces. Device widths of just 50 mm are sufficient to supply 2 motors, while still meeting the approval criteria in accordance with UL 600 V.



### Optional cable shielding

The combination with the BVF 7.62HP ensures a reliable connection between the cable shielding and the device housing, thereby guaranteeing high EMC safety. The screw mount is easy to operate, and meets all requirements in the field.





**The OMNIMATE® Power series for versatile combination options**

The new SVD 7.62HP can be combined with all BVZ 7.62HP and BVF 7.62HP female plugs in the OMNIMATE® Power series.



**Solutions with PUSH IN connection**

Can be implemented in combination with female plug BVF (BVFL) 7.62HP. For especially quick and easy installation without the need for tools. Available with or without flange fastening – optional with screw flange.

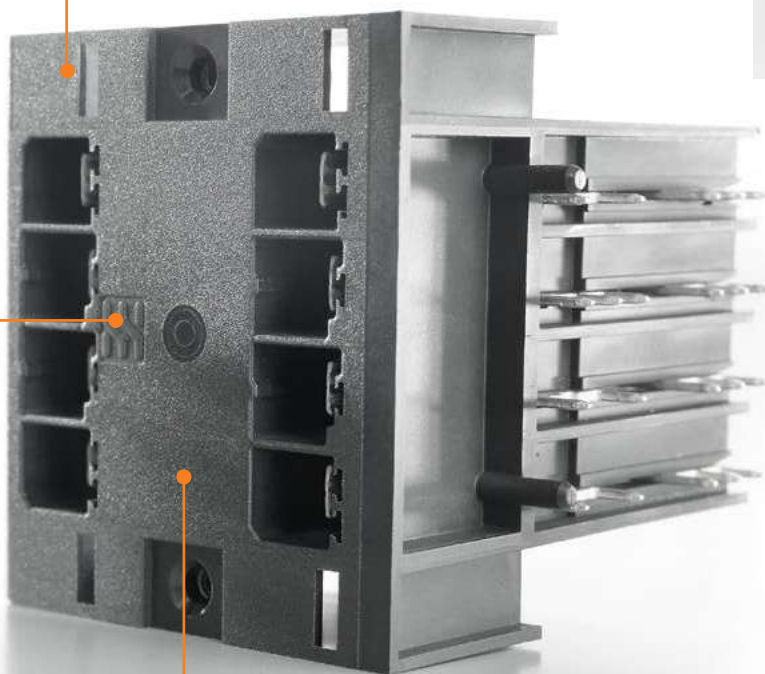

**Solutions with screw connections**

Can be implemented in combination with female plug BVZ 7.62HP. Available without extra fastening or, optionally, as a flange design – e. g. for applications in medium-voltage systems.



**Your special advantages:**

**More design flexibility for the front of the device and the PCB**

The superior solution for when multiple axes need to be plugged into the device in a very small space. Despite the very compact dimensions, the cable shielding can be connected to the front of the device.



With servo regulators in particular, the SVD 7.62HP allows for more complexity than ever before, thanks to the two connection levels for female plugs with conventional screw connection or PUSH IN connection technology. With additional flange fastening on request, and with the option of connecting the cable shielding to the device housing.



## Safe-to-touch, solid and pluggable

### Our feed-through terminals also support thick housing walls

A cable feed-through connection for housing or cabinet walls should be robust and easy to handle. This claim gets fast to a challenge when we talk about the thickness of die-cast aluminium housings.

Our pluggable panel feed-through connection SVF 7.62HP SFMF (SFBMF) in IP 20 copes this job perfectly. Thanks to the two-sided finger safety clearance of 3 mm, this solution can be used safely even in applications with backwards voltages and is therefore suitable for use in an industrial environment without an inverted mating profile. One hand is enough to plug the counterpart BVF 7.62HP 180 MF and to latch them.

Feel free to use this universal plug device at control cabinets. Or use it for the power-input and power-output connection of electronic housings.

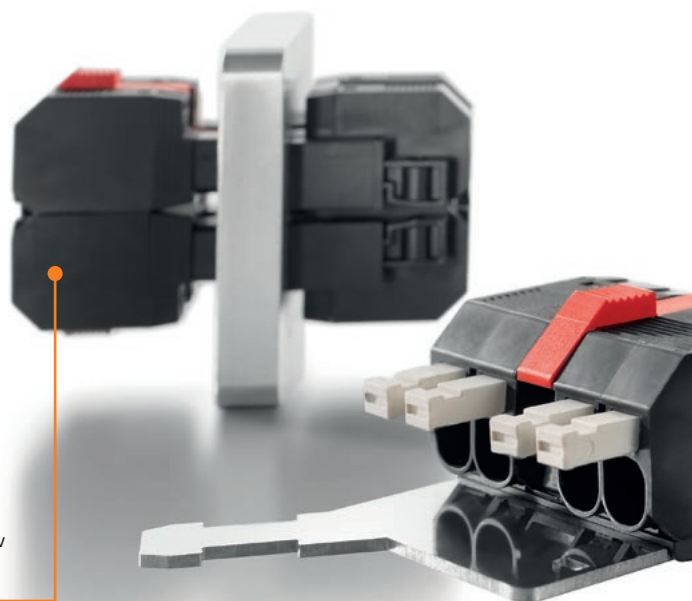

#### Pin number extension to > 4 pins

Use our SVF/BVF 7.62HP COUPLE SET for extensions. Each of the two mating partners can thus be connected back-to-back to a 2-row connector with a maximum of 2 x 4 poles.



**One-handed operation with locking**

The mating partner BVF 7.62HP impresses with its one-hand operation and automatic snap-in. If required by a directive, it can be optionally secured with an additional screw.



**Panel feed-through up to 16 mm as per UL**

Without additional measures for maintaining the clearance and creepage distances as per UL, two versions for walls up to 2 mm or up to 16 mm are available. The maximum wire cross section is AWG 8 or 10 mm<sup>2</sup>.

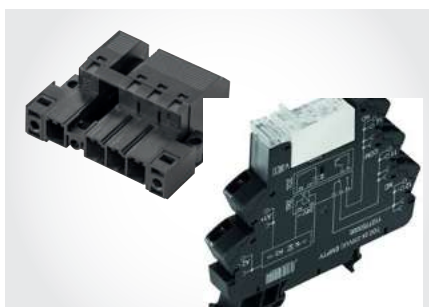

**Your special advantages:**

**Back-to-back**



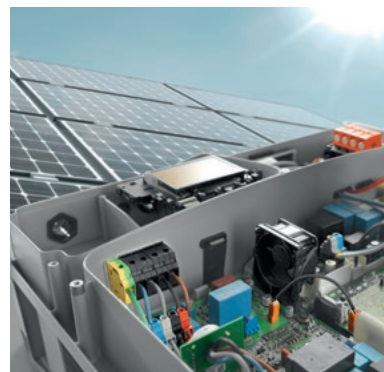

Our plug-in panel feed-through is particularly impressive with automatic locking and the ability to couple two plug-in mating partners.



Our flexible, plug-in supply connections reduce installation and service costs in the signal range up to 41 A. They thus address the much increased demands in the field of signal processing devices, such as photovoltaic inverters.



<http://www.OMNIMATE.net>

-  = Wire-to-Board
-  = Board-to-Board
-  = Wire-to-Wire
-  = Board-to-Wire

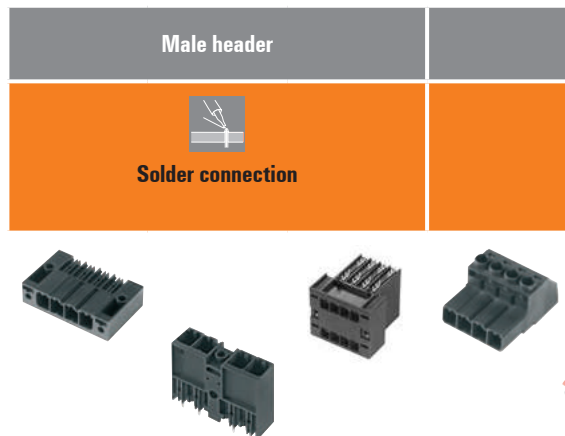
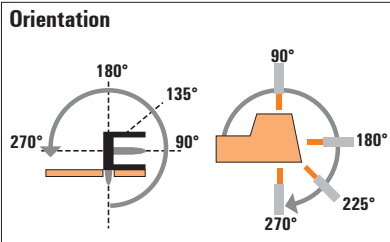
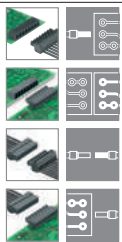

**BV/SV 7.62 series**



Type	SV- SMT	SV	SVD	SVZ
Orientation	90° /180°/270°	90° /180°/270°	270°	180°
Flange options	G/F/SF/MF/MSF	G/F/SF/MF/MSF	G/F	G/F/SF
Product code numbers	IEC: 1.000 V/41 A UL: 300 V/40.5 A	IEC: 1.000 V/41 A UL: 300 V/40.5 A	IEC: 1.000 V/47 A UL: 300 V/30 A	IEC: 1.000 V/41 A 0.2 - 6 mm <sup>2</sup> UL: 600 V/42 A/ AWG 24 - 8

Female plug	Screw Clamping yoke	BVZ		IEC: 1.000 V/57 A/0.2 - 10 mm <sup>2</sup> UL: 600 V/40.5 A/AWG 24 - 8	○	○	○	●
		180°	(G)/F/SF					
Female plug	Spring PUSH IN	BVZ		IEC: 1.000 V/57 A/0.2 - 10 mm <sup>2</sup> UL: 600 V/40.5 A/AWG 24 - 8	○	○	○	●
		180°	FC/SFC					
Female plug	Solder connection	BVZ		IEC: 1.000 V/57 A/0.2 - 10 mm <sup>2</sup> UL: 600 V/40.5 A/AWG 24 - 8	○	○	○	●
		180°	SH...					
Female plug	Solder connection	BVZ		IEC: 1.000 V/57 A/0.2 - 10 mm <sup>2</sup> UL: 600 V/40.5 A/AWG 24 - 8	○	○	○	●
		180°	SH... C					
Female plug	Solder connection	BVF		IEC: 1.000 V/57 A/0.2 - 10 mm <sup>2</sup> UL: 600 V/39 A/AWG 24 - 8	○	○	○	●
		180°	(G)/F/SF/MF/MSF					
Female plug	Solder connection	BVFL		IEC: 1.000 V/57 A/0.2 - 10 mm <sup>2</sup> UL: 600 V/39 A/AWG 24 - 8	○	○	○	●
		180°	(G)/F/SF/MF/MSF					
Female header	Solder connection	BVL		IEC: 1.000 V/41 A UL: 300 V/35 A	●	●	●	●
		90°	(G)/FI/SFI					
		BVL		IEC: 1.000 V/41 A UL: 300 V/35 A				
		180°	(G)/FI/SFI					
		BVL		IEC: 1.000 V/41 A UL: 300 V/35 A				
		270°	(G)/FI/SFI					

**Female plug and header:**

- (G) = Closed (without flange)
- F = Flange with clasp
- SF = Flange with clasp and additional screw
- SFC = Flange with clasp and additional screw
- FI = Inverted flange with clasp
- SFI = Inverted flange with clasp and additional screw

- FC = Flange with clasp
- SH... = Shielded flange with additional nut
- SH... C = Shielded flange with additional screw
- MF = Centre flange for clasp
- MSF = Centre flange for clasp with additional nut

Male plug



Screw  
Clamping yoke



Spring  
PUSH IN

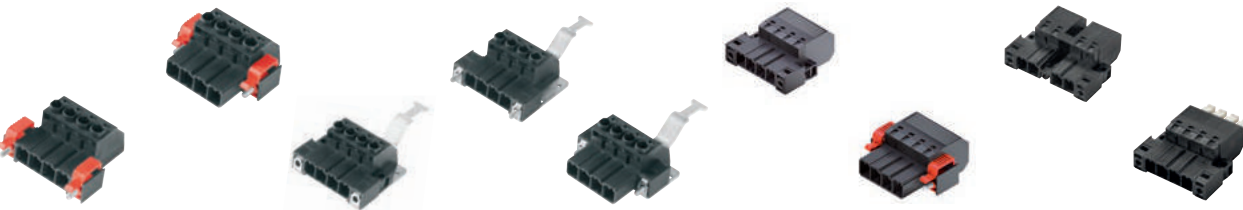

SVZ	SVZ	SVZ	SVZ	SVZ	SVF	SVF	SVF	SVFL
180°	180°	180°	180°	180°	180°	180°	180°	180°
G/FC/SFC	G/FI/SFI	SH	SHC	SHI	G/F/SF	G/FI/SFI	MF/MSF/SFMF/SFBMF	G/F/MF
IEC: 1.000 V/41 A/ 0.2 - 6 mm <sup>2</sup> UL: 600 V/42 A/ AWG 24 - 8	IEC: 1.000 V/41 A/ 0.2 - 6 mm <sup>2</sup> UL: 600 V/42 A/ AWG 24 - 8	IEC: 1.000 V/41 A/ 0.2 - 6 mm <sup>2</sup> UL: 600 V/42 A/ AWG 24 - 8	IEC: 1.000 V/41 A/ 0.2 - 6 mm <sup>2</sup> UL: 600 V/42 A/ AWG 24 - 8	IEC: 1.000 V/41 A/ 0.2 - 6 mm <sup>2</sup> UL: 600 V/42 A/ AWG 24 - 8	IEC: 1.000 V/41 A/ 0.5 - 10 mm <sup>2</sup> UL: 600 V/36 A/ AWG 24 - 10	IEC: 1.000 V/41 A/ 0.5 - 10 mm <sup>2</sup> UL: 600 V/36 A/ AWG 24 - 10	IEC: 1.000 V/41 A/ 0.5 - 10 mm <sup>2</sup> UL: 600 V/36 A/ AWG 24 - 10	IEC: 1.000 V/41 A/ 0.5 - 10 mm <sup>2</sup> UL: 600 V/36 A/ AWG 24 - 10
		●	●		●			●
●			●					
		●			●			●
●								
		●	●		●		●	●
		●	●		●		●	●
	●			●		●		
	●			●		●		
	●			●		●		

Male header and plug:

- G = Closed (without flange)
- F = Flange with clasp
- SF = Flange with clasp and additional screw
- FI = Inverted flange with clasp
- SFI = Inverted flange with clasp and additional screw
- FC = Flange with clasp

- SFC = Flange with clasp and additional screw
- SH... = Shielded flange with additional nut
- MF = Centre flange for clasp
- MSF = Centre flange for clasp with additional nut

Plug-in connector, pitch 7.62 mm  
BV/SV 7.62 series - connection up to 6 mm<sup>2</sup>

SV-SMT 7.62HP../90

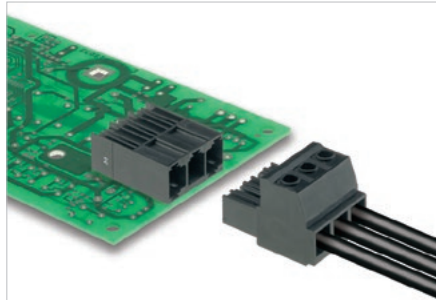

Male header with 90° outlet direction for 400 V TNC(S) systems. UL approval for 600 V in accordance with UL61800-5-1/UL840. The pin arrangement ensures more than 3 mm of finger safety in accordance with IEC 61800-5-1.

Maximum operational reliability thanks to derating up to 125°C, a 100% failsafe pin arrangement, unique coding diversity and additional fastening.

Variants: flange, screw flange and middle flange fastening.

The high-temperature-resistant OMNIMATE® Power male header with THR (through-hole reflow) technology, suitable for the SMT process.

Technical data

In compliance with IEC 60664-1 / IEC 61984

Clamping range, max.			
<b>Solid core H05(07) V-U</b>			
Stranded H07 V-R			
Flexible H05(07) V-K			
Flexible with ferrule			
Ferrule with plastic collar			
Stripping length			
Screwdriver blade	mm		
According to norm			
Tightening torque range			
<b>Rated current, max.</b>	<b>A</b>	<b>41</b>	<b>41</b>
At ambient temperature		20°C	40°C
For conductor cross-section			
Overvoltage category		III	III II
Pollution severity		3	2 2
<b>Rated voltage</b>	<b>V</b>	<b>630</b>	<b>630 1000</b>
Rated impulse voltage	kV	6	6 6
<b>UL / CUL (Use Group)</b>		<b>B</b>	<b>C D</b>

<b>Rated voltage</b>			
<b>Rated current</b>			
<b>AWG conductor</b>	<b>AWG</b>		
<b>CSA (Use Group)</b>		<b>B</b>	<b>C D</b>

Rated voltage			
Rated current			
AWG conductor	AWG		
<b>General data</b>			
Type of insulation material		PA GF	
UL 94 flammability rating		V-0	
Contact base material		Copper alloy	
Material of contact surface		tinned	
Pin dimensions = d	mm	0.8 x 1.0	
Solder eyelet Ø = D	mm	1.3	
Solder eyelet Ø tolerance	mm	+ 0,1	

Product data

IEC: 1000 V / 41 A  
UL:



For additional articles and information, refer to [catalog.weidmueller.com](http://catalog.weidmueller.com)

Note:

- Additional colours on request
- Rated current related to rated cross-section & min. No. of poles.
- P on drawing = pitch
- Rated data refer only to the component itself. Clearance and creepage distances to other components are to be designed in accordance with the relevant application standards.

SV-SMT 7.62HP../90G Box



Dimensioned drawing

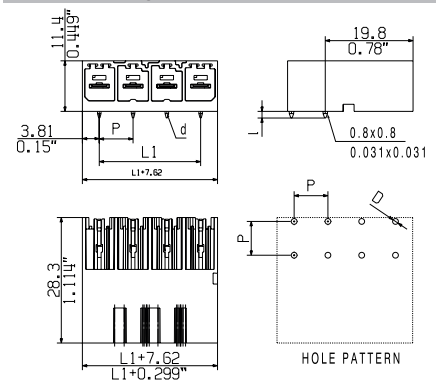

Accessories

Note: Refer to the Accessories chapter for additional accessories.

Coding		Order No.
	BV/SV 7.62HP KO	1937590000

Ordering data

Solder pin length	2.6 mm			
Colour	Black			
<b>Pitch</b>	<b>7.62 mm</b>			
Pol.	L1	(inch)	Qty.	Order No.
2	7.62	0.300	120	2499320000
3	15.24	0.600	50	2499500000
4	22.86	0.900	50	2499550000
5	30.48	1.200	48	2499560000

SV-SMT 7.62HP../90G Tape



Dimensioned drawing

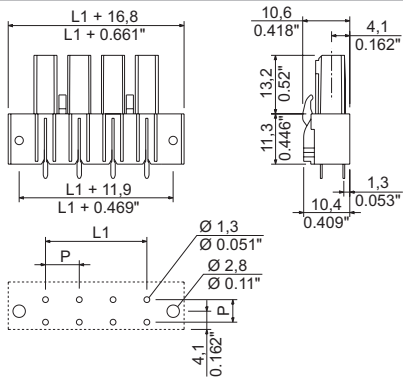

Ordering data

Solder pin length		2.6 mm		
Colour		Black		
Pitch		7.62 mm		
Pol.	L1	(inch)	Qty.	Order No.
2	7.62	0.300	110	2545800000
3	15.24	0.600	110	2546110000
4	22.86	0.900	110	2546120000
5	30.48	1.200	110	2546130000

SV-SMT 7.62HP../90F Box



Dimensioned drawing

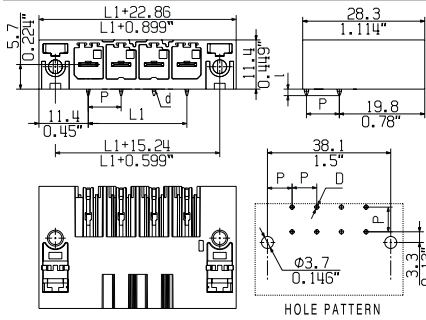

Ordering data

Solder pin length		2.6 mm		
Colour		Black		
Pitch		7.62 mm		
Pol.	L1	(inch)	Qty.	Order No.
2	7.62	0.300	50	2499520000
3	15.24	0.600	50	2499570000
4	22.86	0.900	50	2499580000
5	30.48	1.200	50	2499590000

SV-SMT 7.62HP../90SF Box



Dimensioned drawing

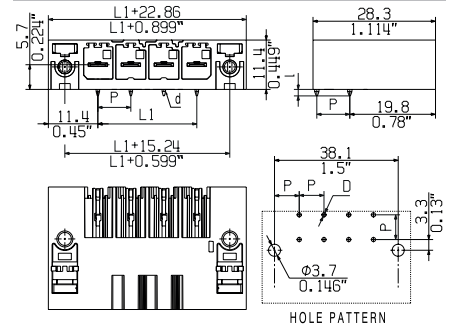

Ordering data

Solder pin length		2.6 mm		
Colour		Black		
Pitch		7.62 mm		
Pol.	L1	(inch)	Qty.	Order No.
2	22.86	0.900	50	2499600000
3	15.24	0.600	50	2499610000
4	22.86	0.900	36	2499620000
5	30.48	1.200	50	2499630000

Plug-in connector, pitch 7.62 mm  
BV/SV 7.62 series - connection up to 6 mm<sup>2</sup>

SV-SMT 7.62HP/./90

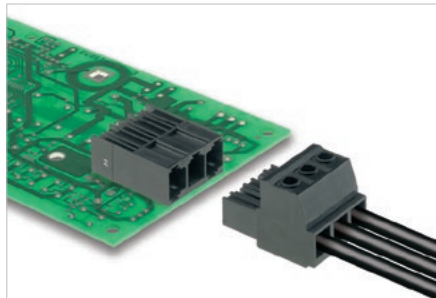

Male header with 90° outlet direction for 400 V TNC(S) systems. UL approval for 600 V in accordance with UL61800-5-1/UL840. The pin arrangement ensures more than 3 mm of finger safety in accordance with IEC 61800-5-1.

Maximum operational reliability thanks to derating up to 125°C, a 100% failsafe pin arrangement, unique coding diversity and additional fastening.

Variants: flange, screw flange and middle flange fastening.

The high-temperature-resistant OMNIMATE® Power male header with THR (through-hole reflow) technology, suitable for the SMT process.

Technical data

In compliance with IEC 60664-1 / IEC 61984

Clamping range, max.			
<b>Solid core H05(07) V-U</b>			
Stranded H07 V-R			
Flexible H05(07) V-K			
Flexible with ferrule			
Ferrule with plastic collar			
Stripping length			
Screwdriver blade	mm		
According to norm			
Tightening torque range			
<b>Rated current, max.</b>	<b>A</b>	<b>41</b>	<b>41</b>
At ambient temperature		20°C	40°C
For conductor cross-section			
Overvoltage category		III	III
Pollution severity		3	2
<b>Rated voltage</b>	<b>V</b>	<b>630</b>	<b>630</b>
Rated impulse voltage	kV	6	6
<b>UL / CUL (Use Group)</b>		<b>B</b>	<b>C</b>

<b>Rated voltage</b>			
<b>Rated current</b>			
<b>AWG conductor</b>	<b>AWG</b>		
<b>CSA (Use Group)</b>		<b>B</b>	<b>C</b>

Rated voltage			
Rated current			
AWG conductor	AWG		

<b>General data</b>			
Type of insulation material		PA GF	
UL 94 flammability rating		V-0	
Contact base material		Copper alloy	
Material of contact surface		tinned	
Pin dimensions = d	mm	0.8 x 1.0	
Solder eyelet Ø = D	mm	1.3	
Solder eyelet Ø tolerance	mm	+ 0,1	

Product data

IEC: 1000 V / 41 A

UL:



For additional articles and information, refer to [catalog.weidmuller.com](http://catalog.weidmuller.com)

Note:

- Additional colours on request
- Rated current related to rated cross-section & min. No. of poles.
- P on drawing = pitch
- Rated data refer only to the component itself. Clearance and creepage distances to other components are to be designed in accordance with the relevant application standards.

SV-SMT 7.62HP/./90SF Tape



Dimensioned drawing

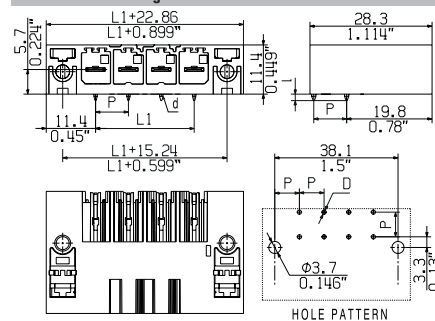

Accessories

Note: Refer to the Accessories chapter for additional accessories.

Coding	Order No.
BV/SV 7.62HP KO	1937590000

Ordering data

Solder pin length	2.6 mm			
Colour	Black			
<b>Pitch</b>	<b>7.62 mm</b>			
Pol.	L1	(inch)	Qty.	Order No.
2	7.62	0.300	110	2545810000
3	15.24	0.600	110	2545950000
4	22.86	0.900	95	2545960000
5	15.24	0.600	95	2545970000



SV-SMT 7.62HP/./90LF Box



SV-SMT 7.62HP/./90LSF Box



Dimensioned drawing

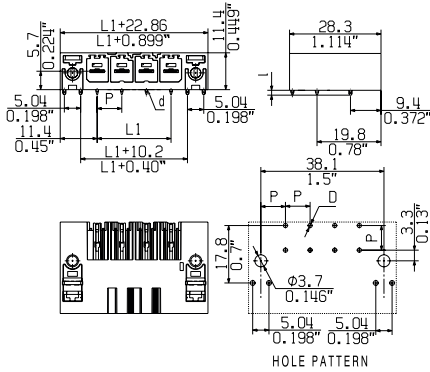

Dimensioned drawing

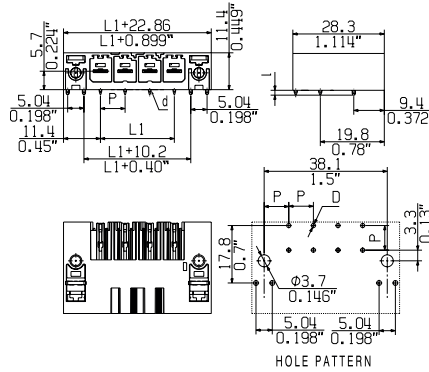

Ordering data

Solder pin length		2.6 mm		
Colour		Black		
Pitch		7.62 mm		
Pol.	L1	(inch)	Qty.	Order No.
2	7.62	0.300	50	2499640000
3	15.24	0.600	50	2499650000
4	22.86	0.900	50	2499660000
5	30.48	1.200	50	2499670000

Ordering data

Solder pin length		2.6 mm		
Colour		Black		
Pitch		7.62 mm		
Pol.	L1	(inch)	Qty.	Order No.
2	7.62	0.300	50	2499680000
3	15.24	0.600	50	2499690000
4	22.86	0.900	50	2499700000
5	30.48	1.200	50	2499710000

**Plug-in connector, pitch 7.62 mm**  
**BV/SV 7.62 series - connection up to 6 mm<sup>2</sup>**

**SV-SMT 7.62HP../270**

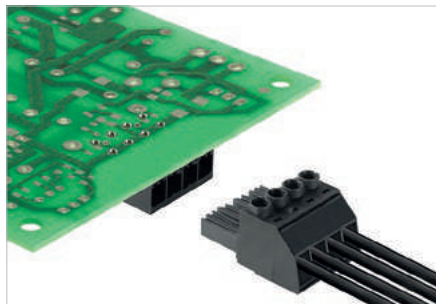

Male header with 270° outlet direction for 400 V TNC(S) systems. UL approval for 600 V in accordance with UL61800-5-1/UL840. The pin arrangement ensures finger safety of >3 mm in accordance with IEC 61800-5-1. Maximum operational reliability thanks to derating up to 125°C, a 100% failsafe pin arrangement, unique coding diversity and additional fastening.

Variants: flange, screw flange and middle flange fastening.

The high-temperature-resistant OMNIMATE® Power male header with THR (through-hole reflow) technology, suitable for the SMT process.

**Product data**

IEC: 1000 V / 41 A  
 UL:



For additional articles and information, refer to [catalog.weidmueller.com](http://catalog.weidmueller.com)

**Note:**

- Additional colours on request
- Rated current related to rated cross-section & min. No. of poles.
- P on drawing = pitch
- Rated data refer only to the component itself. Clearance and creepage distances to other components are to be designed in accordance with the relevant application standards.

**SV-SMT 7.62HP../270G Box**



**Dimensioned drawing**

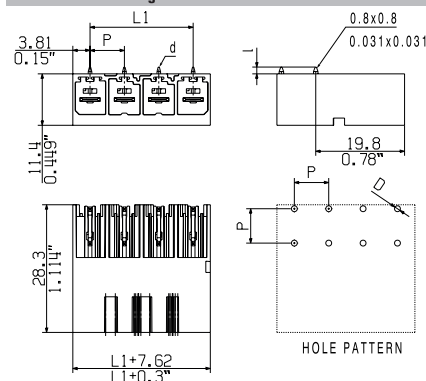

**Technical data**

**In compliance with IEC 60664-1 / IEC 61984**

Clamping range, max.			
<b>Solid core H05(07) V-U</b>			
Stranded H07 V-R			
Flexible H05(07) V-K			
Flexible with ferrule			
Ferrule with plastic collar			
Stripping length			
Screwdriver blade	mm		
According to norm			
Tightening torque range			
<b>Rated current, max.</b>	<b>A</b>	<b>41</b>	<b>41</b>
At ambient temperature		20°C	40°C
For conductor cross-section			
Overvoltage category		III	III II
Pollution severity		3	2 2
<b>Rated voltage</b>	<b>V</b>	<b>630</b>	<b>630 1000</b>
Rated impulse voltage	kV	6	6 6
<b>UL / CUL (Use Group)</b>		<b>B</b>	<b>C D</b>

<b>Rated voltage</b>			
<b>Rated current</b>			
<b>AWG conductor</b>	<b>AWG</b>		
<b>CSA (Use Group)</b>		<b>B</b>	<b>C D</b>

Rated voltage		
Rated current		
<b>AWG conductor</b>	<b>AWG</b>	

<b>General data</b>		
Type of insulation material		PA GF
UL 94 flammability rating		V-0
Contact base material		Copper alloy
Material of contact surface		tinned
Pin dimensions = d	mm	0.8 x 1.0
Solder eyelet Ø = D	mm	1.3
Solder eyelet Ø tolerance	mm	+ 0,1

**Accessories**

**Note:** Refer to the Accessories chapter for additional accessories.

Coding		Order No.
	BV/SV 7.62HP KO	1937590000



**Ordering data**

<b>Solder pin length</b>	<b>2.6 mm</b>			
<b>Colour</b>	<b>Black</b>			
<b>Pitch</b>	<b>7.62 mm</b>			
Pol.	L1	(inch)	Qty.	Order No.
2	7.62	0.300	120	2499330000
3	15.24	0.600	50	2499340000
4	22.86	0.900	50	2499350000
5	30.48	1.200	50	2499360000



**Plug-in connector, pitch 7.62 mm**  
**BV/SV 7.62 series - connection up to 6 mm<sup>2</sup>**

**SV-SMT 7.62HP../270**

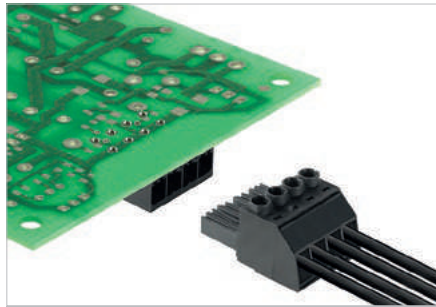

Male header with 270° outlet direction for 400 V TNC(S) systems. UL approval for 600 V in accordance with UL61800-5-1/UL840. The pin arrangement ensures finger safety of >3 mm in accordance with IEC 61800-5-1. Maximum operational reliability thanks to derating up to 125°C, a 100% failsafe pin arrangement, unique coding diversity and additional fastening.

Variants: flange, screw flange and middle flange fastening.

The high-temperature-resistant OMNIMATE® Power male header with THR (through-hole reflow) technology, suitable for the SMT process.

**Product data**

IEC: 1000 V / 41 A  
 UL:



For additional articles and information, refer to [catalog.weidmueller.com](http://catalog.weidmueller.com)

**Note:**

- Additional colours on request
- Rated current related to rated cross-section & min. No. of poles.
- P on drawing = pitch
- Rated data refer only to the component itself. Clearance and creepage distances to other components are to be designed in accordance with the relevant application standards.

**SV-SMT 7.62HP../270SF Tape**



**Dimensioned drawing**

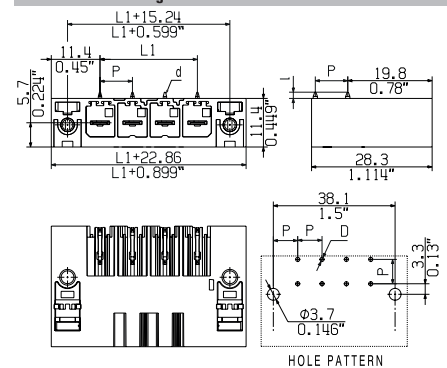

**Technical data**

**In compliance with IEC 60664-1 / IEC 61984**

Clamping range, max.			
<b>Solid core H05(07) V-U</b>			
Stranded H07 V-R			
Flexible H05(07) V-K			
Flexible with ferrule			
Ferrule with plastic collar			
Stripping length			
Screwdriver blade	mm		
According to norm			
Tightening torque range			
<b>Rated current, max.</b>	<b>A</b>	<b>41</b>	<b>41</b>
At ambient temperature		20°C	40°C
For conductor cross-section			
Overtoltage category		III	III
Pollution severity		3	2
<b>Rated voltage</b>	<b>V</b>	<b>630</b>	<b>630</b>
Rated impulse voltage	kV	6	6
<b>UL / CUL (Use Group)</b>		<b>B</b>	<b>C</b>

<b>Rated voltage</b>			
<b>Rated current</b>			
<b>AWG conductor</b>	<b>AWG</b>		
<b>CSA (Use Group)</b>		<b>B</b>	<b>C</b>

Rated voltage		
Rated current		
AWG conductor	AWG	-

<b>General data</b>		
Type of insulation material		PA GF
UL 94 flammability rating		V-0
Contact base material		Copper alloy
Material of contact surface		tinned
Pin dimensions = d	mm	0.8 x 1.0
Solder eyelet Ø = D	mm	1.3
Solder eyelet Ø tolerance	mm	+ 0,1

**Accessories**

**Note:** Refer to the Accessories chapter for additional accessories.

Coding	Order No.
BV/SV 7.62HP KO	1937590000



**Ordering data**

<b>Solder pin length</b>	<b>2.6 mm</b>			
<b>Colour</b>	<b>Black</b>			
<b>Pitch</b>	<b>7.62 mm</b>			
Pol.	L1	(inch)	Qty.	Order No.
2	7.62	0.300	110	2546020000
3	15.24	0.600	110	2546030000
4	22.86	0.900	95	2546040000
5	30.48	1.200	95	2546050000



**Plug-in connector, pitch 7.62 mm**  
**BV/SV 7.62 series - connection up to 6 mm<sup>2</sup>**

**SV 7.62HP../90**

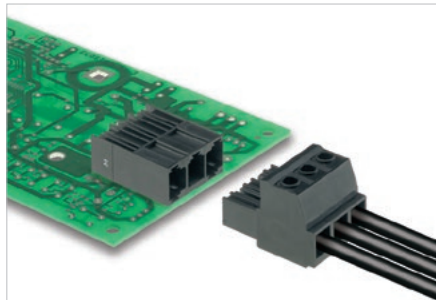

Male header with 90° outlet direction for 400 V TNC(S) systems. UL approval for 600 V in acc. with UL61800-5-1 / UL840. The pin arrangement ensures more than 3 mm of touch-safety in acc. with IEC 61800-5-1.

Maximum connection and operating reliability thanks to: derating up to 125°C, pin arrangement that prevents wrong connections or incorrect wiring, unique coding diversity, additional fastening.

Variants: flange, screw flange and middle flange fastening.

**Product data**

IEC: 1000 V / 57 A  
 UL: 300 V / 40.5 A



For additional articles and information, refer to [catalog.weidmuller.com](http://catalog.weidmuller.com)

**Note:**

- Additional colours on request
- Rated current related to rated cross-section & min. No. of poles.
- P on drawing = pitch
- Rated data refer only to the component itself. Clearance and creepage distances to other components are to be designed in accordance with the relevant application standards.
- Diameter of solder eyelet D = 1.4+0.1 mm starting with 8-pole

**SV 7.62HP../90G**



**Dimensioned drawing**

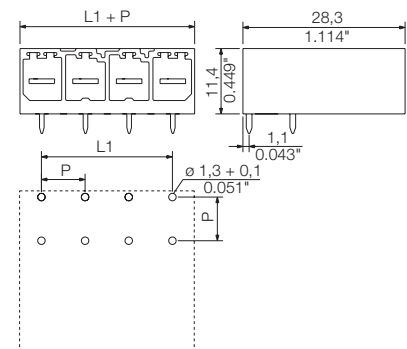

**Technical data**

**In compliance with IEC 60664-1 / IEC 61984**

Clamping range, max.			
<b>Solid core H05(07) V-U</b>			
Stranded H07 V-R			
Flexible H05(07) V-K			
Flexible with ferrule			
Ferrule with plastic collar			
Stripping length			
Screwdriver blade	mm		
According to norm			
Tightening torque range			
<b>Rated current, max.</b>	<b>A</b>	<b>57</b>	<b>41</b>
At ambient temperature		20°C	40°C
For conductor cross-section			
Overtoltage category		III	III II
Pollution severity		3	2 2
<b>Rated voltage</b>	<b>V</b>	<b>630</b>	<b>630 1000</b>
Rated impulse voltage	kV	6	6 6
<b>UL / CUL (Use Group)</b>		<b>B</b>	<b>C D</b>
<b>Rated voltage</b>	<b>V</b>	<b>300</b>	<b>300 600</b>
<b>Rated current</b>	<b>A</b>	<b>40.5</b>	<b>40.5 5</b>
<b>AWG conductor</b>	<b>AWG</b>		<b>-</b>
<b>CSA (Use Group)</b>		<b>B</b>	<b>C D</b>
Rated voltage	V	300	300 600
Rated current	A	35	35 5
AWG conductor	AWG		-
<b>General data</b>			
Type of insulation material		PA GF	
UL 94 flammability rating		V-0	
Contact base material		Copper alloy	
Material of contact surface		tinned	
Pin dimensions = d	mm	0.8 x 1.0	
Solder eyelet Ø = D	mm	1.3	
Solder eyelet Ø tolerance	mm	+ 0,1	

**Accessories**

**Note:** Refer to the Accessories chapter for additional accessories.

Coding	Order No.
BV/SV 7.62HP K0	1937590000



**Ordering data**

Solder pin length		3.5 mm		
Colour		Black		
Pitch		7.62 mm		
Pol.	L1 (inch)	Qty.	Order No.	
2	7.62	120	1930270000	
3	15.24	78	1930280000	
4	22.86	60	1930290000	
5	30.48	48	1930300000	
6	38.10	36	1930310000	
7	45.72	30	1930320000	
8	53.34	30	1930330000	
9	60.96	24	1930340000	
10	68.58	24	1930350000	
11	76.20	18	1930360000	
12	83.82	18	1930370000	

SV 7.62HP../90F



SV 7.62HP../90SF



Dimensioned drawing

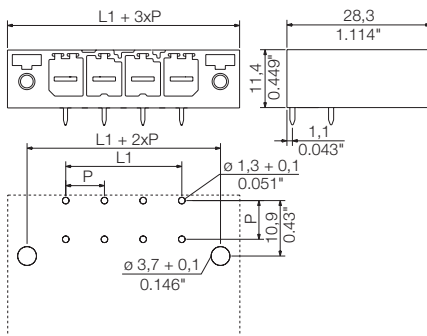

Dimensioned drawing

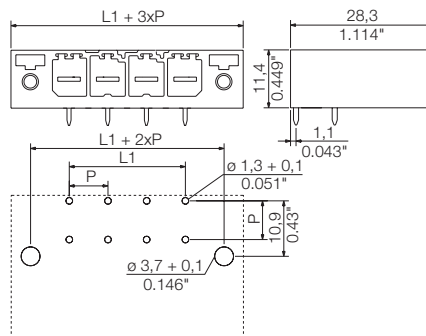

Ordering data

Solder pin length		3.5 mm	
Colour		Black	
Pitch		7.62 mm	
Pol.	L1	(inch)	Qty. Order No.
2	7.62	0.300	60 1930380000
3	15.24	0.600	48 1930390000
4	22.86	0.900	36 1930400000
5	30.48	1.200	30 1930410000
6	38.10	1.500	30 1930420000
7	45.72	1.800	24 1930430000
8	53.34	2.100	24 1930440000
9	60.96	2.400	18 1930450000
10	68.58	2.700	18 1930460000
11	76.20	3.000	18 1930470000
12	83.82	3.300	12 1930480000

Ordering data

Solder pin length		3.5 mm	
Colour		Black	
Pitch		7.62 mm	
Pol.	L1	(inch)	Qty. Order No.
2	7.62	0.300	60 1930490000
3	15.24	0.600	48 1930500000
4	22.86	0.900	36 1930510000
5	30.48	1.200	30 1930520000
6	38.10	1.500	30 1930530000
7	45.72	1.800	24 1930540000
8	53.34	2.100	24 1930550000
9	60.96	2.400	18 1930560000
10	68.58	2.700	18 1930570000
11	76.20	3.000	18 1930580000
12	83.82	3.300	12 1930590000

**Plug-in connector, pitch 7.62 mm**  
**BV/SV 7.62 series - connection up to 6 mm<sup>2</sup>**

**SV 7.62HP/./90MF**

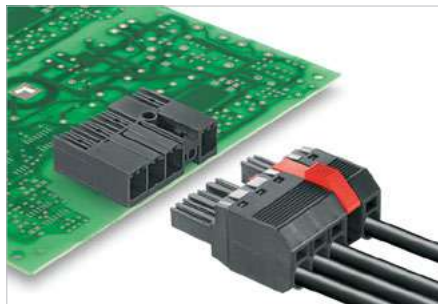

Male header with 90° outlet direction for 400 V TNC(S) systems. UL approval for 600 V in acc. with UL61800-5-1 / UL840. The pin arrangement ensures more than 3 mm of touch-safety in acc. with IEC 61800-5-1.

Maximum connection and operating reliability thanks to: derating up to 125°C, pin arrangement that prevents wrong connections or incorrect wiring, unique coding diversity, additional fastening.

Variants: flange, screw flange and middle flange fastening.

**Technical data**

**In compliance with IEC 60664-1 / IEC 61984**

Clamping range, max.			
<b>Solid core H05(07) V-U</b>			
Stranded H07 V-R			
Flexible H05(07) V-K			
Flexible with ferrule			
Ferrule with plastic collar			
Stripping length			
Screwdriver blade	mm		
According to norm			
Tightening torque range			
<b>Rated current, max.</b>	<b>A</b>	<b>57</b>	<b>41</b>
At ambient temperature		20°C	40°C
For conductor cross-section			
Overvoltage category		III	III II
Pollution severity		3	2 2
<b>Rated voltage</b>	<b>V</b>	<b>630</b>	<b>630 1000</b>
Rated impulse voltage	kV	6	6 6
<b>UL / CUL (Use Group)</b>		<b>B</b>	<b>C D</b>
<b>Rated voltage</b>	<b>V</b>	<b>300</b>	<b>300 600</b>
<b>Rated current</b>	<b>A</b>	<b>40.5</b>	<b>40.5 5</b>
<b>AWG conductor</b>	<b>AWG</b>		<b>-</b>
<b>CSA (Use Group)</b>		<b>B</b>	<b>C D</b>
Rated voltage	V	300	300 600
Rated current	A	35	35 5
AWG conductor	AWG		-
<b>General data</b>			
Type of insulation material		PA GF	
UL 94 flammability rating		V-0	
Contact base material		Copper alloy	
Material of contact surface		tinned	
Pin dimensions = d	mm	0.8 x 1.0	
Solder eyelet Ø = D	mm	1.3	
Solder eyelet Ø tolerance	mm	+ 0,1	

**Product data**

IEC: 1000 V / 57 A  
 UL: 300 V / 40.5 A



For additional articles and information, refer to [catalog.weidmueller.com](http://catalog.weidmueller.com)

**Note:**

- Additional colours on request
- Rated current related to rated cross-section & min. No. of poles.
- P on drawing = pitch
- Rated data refer only to the component itself. Clearance and creepage distances to other components are to be designed in accordance with the relevant application standards.
- MFX and MSFX: X= Position of the middle flange e.g. MF2, MSF3

**SV 7.62HP/./90MF2**



**Dimensioned drawing**

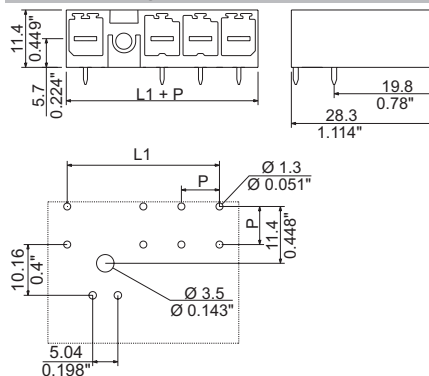

**Accessories**

**Note:** Refer to the Accessories chapter for additional accessories.

Coding	Order No.
BV/SV 7.62HP K0	1937590000

**Ordering data**

Solder pin length		3.5 mm		
Colour		Black		
Pitch		7.62 mm		
Pol.	L1	(inch)	Qty.	Order No.
2	15.24	0.600	78	1048390000
3	22.86	0.900	60	1048500000
4	30.48	1.200	48	1464270000
5	38.10	1.500	36	1464280000
6	45.72	1.800	30	1543090000



SV 7.62HP../90MF3



Dimensioned drawing

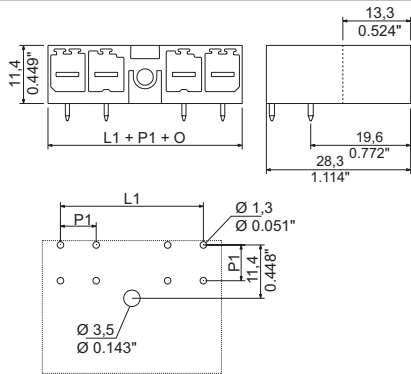

Ordering data

Solder pin length		3.5 mm		
Colour		Black		
Pitch		7.62 mm		
Pol.	L1	(inch)	Qty.	Order No.
3	22.86	0.900	60	1048490000
4	30.48	1.200	48	1048570000
5	38.10	1.500	36	1048690000
6	45.72	1.800	30	1543120000

SV 7.62HP../90MF4



Dimensioned drawing

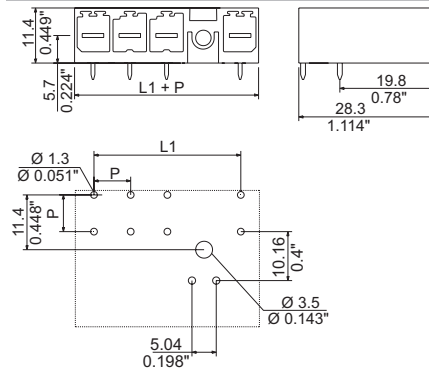

Ordering data

Solder pin length		3.5 mm		
Colour		Black		
Pitch		7.62 mm		
Pol.	L1	(inch)	Qty.	Order No.
4	30.48	1.200	48	1464290000
5	38.10	1.500	36	1048690000
6	45.72	1.800	30	1048760000

**Plug-in connector, pitch 7.62 mm**  
**BV/SV 7.62 series - connection up to 6 mm<sup>2</sup>**

**SV 7.62HP../180**

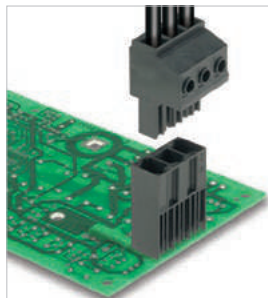

Male header with 180° outlet direction for 400 V TNC(S) systems. UL approval for 600 V in acc. with UL61800-5-1 / UL840. The pin arrangement ensures more than 3 mm of touch-safety in acc. with IEC 61800-5-1.

Maximum connection and operating reliability thanks to: derating up to 125°C, pin arrangement that prevents wrong connections or incorrect wiring, unique coding diversity, additional fastening and integrated positioning aid.

Variants: flange, screw flange and middle flange fastening.

**Product data**

IEC: 1000 V / 57 A  
UL: 300 V / 40.5 A



For additional articles and information, refer to [catalog.weidmueller.com](http://catalog.weidmueller.com)

**Note:**

- Additional colours on request
- Rated current related to rated cross-section & min. No. of poles.
- P on drawing = pitch
- Rated data refer only to the component itself. Clearance and creepage distances to other components are to be designed in accordance with the relevant application standards.
- Diameter of solder eyelet D = 1.4+0.1 mm starting with 8-pole

**SV 7.62HP../180G**



**Dimensioned drawing**

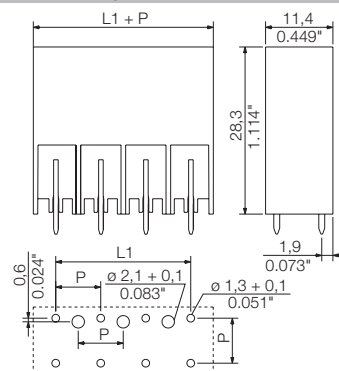

**Technical data**

**In compliance with IEC 60664-1 / IEC 61984**

Clamping range, max.			
<b>Solid core H05(07) V-U</b>			
Stranded H07 V-R			
Flexible H05(07) V-K			
Flexible with ferrule			
Ferrule with plastic collar			
Stripping length			
Screwdriver blade	mm		
According to norm			
Tightening torque range			
<b>Rated current, max.</b>	<b>A</b>	<b>57</b>	<b>41</b>
At ambient temperature		20°C	40°C
For conductor cross-section			
Overvoltage category		III	III II
Pollution severity		3	2 2
<b>Rated voltage</b>	<b>V</b>	<b>630</b>	<b>630 1000</b>
Rated impulse voltage	kV	6	6 6
<b>UL / CUL (Use Group)</b>		<b>B</b>	<b>C D</b>
<b>Rated voltage</b>	<b>V</b>	<b>300</b>	<b>300 600</b>
<b>Rated current</b>	<b>A</b>	<b>40.5</b>	<b>40.5 5</b>
<b>AWG conductor</b>	<b>AWG</b>		<b>-</b>
<b>CSA (Use Group)</b>		<b>B</b>	<b>C D</b>
Rated voltage	V	300	300 600
Rated current	A	35	35 5
AWG conductor	AWG		-
<b>General data</b>			
Type of insulation material		PA GF	
UL 94 flammability rating		V-0	
Contact base material		Copper alloy	
Material of contact surface		tinned	
Pin dimensions = d	mm	0.8 x 1.0	
Solder eyelet Ø = D	mm	1.3	
Solder eyelet Ø tolerance	mm	+ 0,1	

**Accessories**

**Note:** Refer to the Accessories chapter for additional accessories.

Coding	Order No.
BV/SV 7.62HP K0	<b>1937590000</b>
<b>Protection against twisting</b>	
VDS180 SV7.62	<b>1853940000</b>

**Ordering data**

Solder pin length		3.5 mm		
Colour		Black		
Pitch		7.62 mm		
Pol.	L1	(inch)	Qty.	Order No.
2	7.62	0.300	120	<b>1930600000</b>
3	15.24	0.600	78	<b>1930610000</b>
4	22.86	0.900	60	<b>1930620000</b>
5	30.48	1.200	48	<b>1930630000</b>
6	38.10	1.500	36	<b>1930640000</b>
7	45.72	1.800	30	<b>1930650000</b>
8	53.34	2.100	30	<b>1930660000</b>
9	60.96	2.400	24	<b>1930670000</b>
10	68.58	2.700	24	<b>1930680000</b>
11	76.20	3.000	18	<b>1930690000</b>
12	83.82	3.300	18	<b>1930700000</b>

SV 7.62HP../180F



Dimensioned drawing

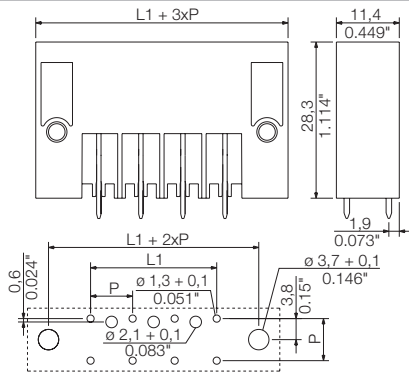

Ordering data

Solder pin length		3.5 mm			
Colour		Black			
Pitch		7.62 mm			
Pol.	L1	(inch)	Qty.	Order No.	
2	7.62	0.300	60	1930710000	
3	15.24	0.600	48	1930720000	
4	22.86	0.900	36	1930730000	
5	30.48	1.200	30	1930740000	
6	38.10	1.500	30	1930750000	
7	45.72	1.800	24	1930760000	
8	53.34	2.100	24	1930770000	
9	60.96	2.400	18	1930780000	
10	68.58	2.700	18	1930790000	
11	76.20	3.000	18	1930800000	
12	83.82	3.300	12	1930810000	

SV 7.62HP../180SF



Dimensioned drawing

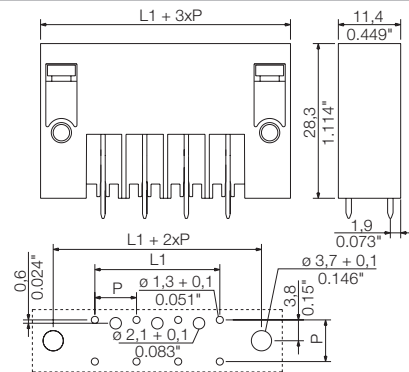

Ordering data

Solder pin length		3.5 mm			
Colour		Black			
Pitch		7.62 mm			
Pol.	L1	(inch)	Qty.	Order No.	
2	7.62	0.300	60	1930820000	
3	15.24	0.600	48	1930830000	
4	22.86	0.900	36	1930840000	
5	30.48	1.200	30	1930850000	
6	38.10	1.500	30	1930860000	
7	45.72	1.800	24	1930870000	
8	53.34	2.100	24	1930880000	
9	60.96	2.400	18	1930890000	
10	68.58	2.700	18	1930900000	
11	76.20	3.000	18	1930910000	
12	83.82	3.300	12	1930920000	

**Plug-in connector, pitch 7.62 mm**  
**BV/SV 7.62 series - connection up to 6 mm<sup>2</sup>**

**SV 7.62HP../180MF**

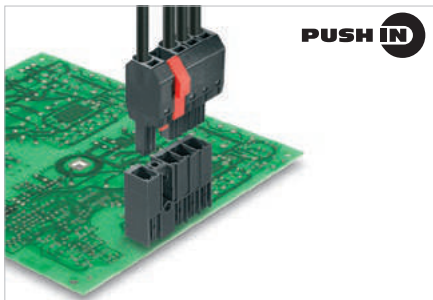

Male header with 180° outlet direction for 400 V TNC(S) systems. UL approval for 600 V in acc. with UL61800-5-1 / UL840. The pin arrangement ensures more than 3 mm of touch-safety in acc. with IEC 61800-5-1.

Maximum connection and operating reliability thanks to: derating up to 125°C, pin arrangement that prevents wrong connections or incorrect wiring, unique coding diversity, additional fastening and integrated positioning aid.

Variants: flange, screw flange and middle flange fastening.

**Product data**

IEC: 1000 V / 57 A  
 UL: 300 V / 40.5 A



For additional articles and information, refer to [catalog.weidmuller.com](http://catalog.weidmuller.com)

**Note:**

- Additional colours on request
- Rated current related to rated cross-section & min. No. of poles.
- P on drawing = pitch
- Rated data refer only to the component itself. Clearance and creepage distances to other components are to be designed in accordance with the relevant application standards.
- MFX and MSFX: X= Position of the middle flange e.g. MF2, MSF3

**SV 7.62HP../180MF2**



**Dimensioned drawing**

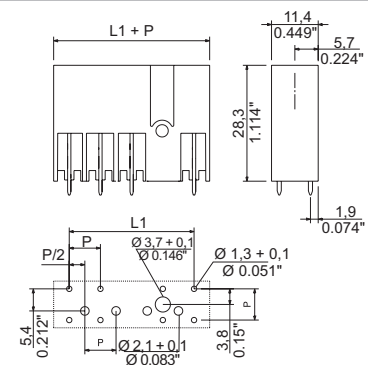

**Technical data**

**In compliance with IEC 60664-1 / IEC 61984**

Clamping range, max.			
<b>Solid core H05(07) V-U</b>			
Stranded H07 V-R			
Flexible H05(07) V-K			
Flexible with ferrule			
Ferrule with plastic collar			
Stripping length			
Screwdriver blade	mm		
According to norm			
Tightening torque range			
<b>Rated current, max.</b>	<b>A</b>	<b>57</b>	<b>41</b>
At ambient temperature		20°C	40°C
For conductor cross-section			
Overvoltage category		III	III II
Pollution severity		3	2 2
<b>Rated voltage</b>	<b>V</b>	<b>630</b>	<b>630 1000</b>
Rated impulse voltage	kV	6	6 6
<b>UL / CUL (Use Group)</b>		<b>B</b>	<b>C D</b>
<b>Rated voltage</b>	<b>V</b>	<b>300</b>	<b>300 600</b>
<b>Rated current</b>	<b>A</b>	<b>40.5</b>	<b>40.5 5</b>
<b>AWG conductor</b>	<b>AWG</b>		<b>-</b>
<b>CSA (Use Group)</b>		<b>B</b>	<b>C D</b>
Rated voltage	V	300	300 600
Rated current	A	35	35 5
AWG conductor	AWG		-
<b>General data</b>			
Type of insulation material		PA GF	
UL 94 flammability rating		V-0	
Contact base material		Copper alloy	
Material of contact surface		tinned	
Pin dimensions = d	mm	0.8 x 1.0	
Solder eyelet Ø = D	mm	1.3	
Solder eyelet Ø tolerance	mm	+ 0,1	

**Accessories**

**Note:** Refer to the Accessories chapter for additional accessories.

Coding		Order No.
	BV/SV 7.62HP KO	1937590000
<b>Protection against twisting</b>		
	VDS180 SV7.62	1853940000

**Ordering data**

<b>Solder pin length</b>		3.5 mm	
<b>Colour</b>		Black	
<b>Pitch</b>		7.62 mm	
Pol.	L1	(inch)	Qty. Order No.
2	15.24	0.600	78 1048350000
3	22.86	0.900	60 1048410000
4	30.48	1.200	48 1464310000
5	38.10	1.500	36 1464320000
6	45.72	1.800	30 1543190000

SV 7.62HP../180MF3



Dimensioned drawing

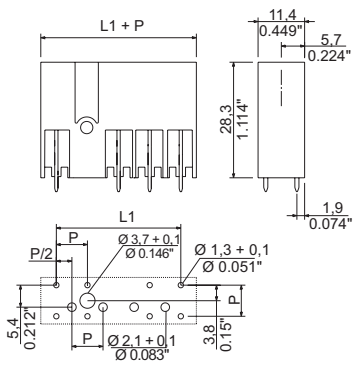

Ordering data

Solder pin length		3.5 mm		
Colour		Black		
Pitch		7.62 mm		
Pol.	L1	(inch)	Qty.	Order No.
3	22.86	0.900	60	1048420000
4	30.48	1.200	48	1048530000
5	38.10	1.500	36	1048590000
6	45.72	1.800	30	1543210000

SV 7.62HP../180MF4



Dimensioned drawing

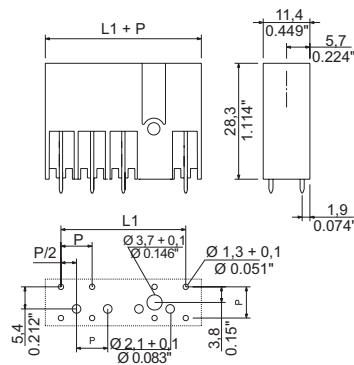

Ordering data

Solder pin length		3.5 mm		
Colour		Black		
Pitch		7.62 mm		
Pol.	L1	(inch)	Qty.	Order No.
4	30.48	1.200	48	1464330000
5	38.10	1.500	36	1048600000
6	45.72	1.800	30	1048720000

**Plug-in connector, pitch 7.62 mm**  
**BV/SV 7.62 series - connection up to 6 mm<sup>2</sup>**

**SV 7.62HP/./270**

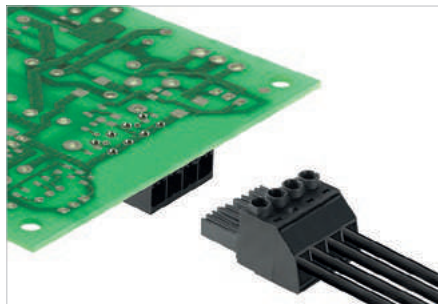

Male header with 270° outlet direction for 400 V TNC(S) systems. UL approval for 600 V in acc. with UL61800-5-1 / UL840. The pin arrangement ensures more than 3 mm of touch-safety in acc. with IEC 61800-5-1.

Maximum connection and operating reliability thanks to: derating up to 125°C, pin arrangement that prevents wrong connections or incorrect wiring, unique coding diversity, additional fastening.

Variants: flange, screw flange and middle flange fastening.

**Product data**

IEC: 1000 V / 57 A  
 UL: 300 V / 40.5 A



For additional articles and information, refer to [catalog.weidmueller.com](http://catalog.weidmueller.com)

**Note:**

- Additional colours on request
- Rated current related to rated cross-section & min. No. of poles.
- P on drawing = pitch
- Rated data refer only to the component itself. Clearance and creepage distances to other components are to be designed in accordance with the relevant application standards.
- Diameter of solder eyelet D = 1.4+0.1 mm starting with 8-pole

**SV 7.62HP/./270G**



**Dimensioned drawing**

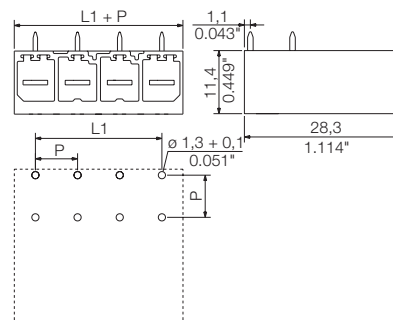

**Technical data**

**In compliance with IEC 60664-1 / IEC 61984**

Clamping range, max.			
<b>Solid core H05(07) V-U</b>			
Stranded H07 V-R			
Flexible H05(07) V-K			
Flexible with ferrule			
Ferrule with plastic collar			
Stripping length			
Screwdriver blade	mm		
According to norm			
Tightening torque range			
<b>Rated current, max.</b>	<b>A</b>	<b>57</b>	<b>41</b>
At ambient temperature		20°C	40°C
For conductor cross-section			
Overtoltage category		III	III II
Pollution severity		3	2 2
<b>Rated voltage</b>	<b>V</b>	<b>630</b>	<b>630 1000</b>
Rated impulse voltage	kV	6	6 6
<b>UL / CUL (Use Group)</b>		<b>B</b>	<b>C D</b>
<b>Rated voltage</b>	<b>V</b>	<b>300</b>	<b>300 600</b>
<b>Rated current</b>	<b>A</b>	<b>40.5</b>	<b>40.5 5</b>
<b>AWG conductor</b>	<b>AWG</b>		<b>-</b>
<b>CSA (Use Group)</b>		<b>B</b>	<b>C D</b>
Rated voltage	V	300	300 600
Rated current	A	35	35 5
AWG conductor	AWG		-
<b>General data</b>			
Type of insulation material		PA GF	
UL 94 flammability rating		V-0	
Contact base material		Copper alloy	
Material of contact surface		tinned	
Pin dimensions = d	mm	0.8 x 1.0	
Solder eyelet Ø = D	mm	1.3	
Solder eyelet Ø tolerance	mm	+ 0,1	

**Accessories**

**Note:** Refer to the Accessories chapter for additional accessories.

Coding		Order No.
	BV/SV 7.62HP KO	1937590000

**Ordering data**

Solder pin length		3.5 mm		
Colour		Black		
Pitch		7.62 mm		
Pol.	L1	(inch)	Qty.	Order No.
2	7.62	0.300	120	1931260000
3	15.24	0.600	78	1931270000
4	22.86	0.900	60	1931280000
5	30.48	1.200	48	1931290000
6	38.10	1.500	36	1931300000
7	45.72	1.800	30	1931310000
8	53.34	2.100	30	1931320000
9	60.96	2.400	24	1931330000
10	68.58	2.700	24	1931340000
11	76.20	3.000	18	1931350000
12	83.82	3.300	18	1931360000

SV 7.62HP../270F



Dimensioned drawing

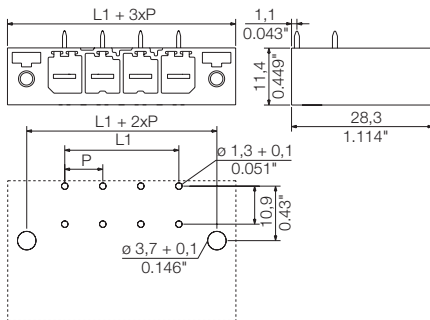

Ordering data

Solder pin length		3.5 mm	
Colour		Black	
Pitch		7.62 mm	
Pol.	L1 (inch)	Qty.	Order No.
2	7.62	0.300	60 1931370000
3	15.24	0.600	48 1931380000
4	22.86	0.900	36 1931390000
5	30.48	1.200	30 1931400000
6	38.10	1.500	30 1931410000
7	45.72	1.800	24 1931420000
8	53.34	2.100	24 1931430000
9	60.96	2.400	18 1931440000
10	68.58	2.700	18 1931450000
11	76.20	3.000	18 1931460000
12	83.82	3.300	12 1931470000

SV 7.62HP../270SF



Dimensioned drawing

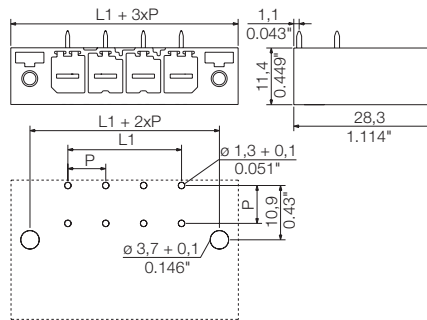

Ordering data

Solder pin length		3.5 mm	
Colour		Black	
Pitch		7.62 mm	
Pol.	L1 (inch)	Qty.	Order No.
2	7.62	0.300	60 1931480000
3	15.24	0.600	48 1931490000
4	22.86	0.900	36 1931500000
5	30.48	1.200	30 1931510000
6	38.10	1.500	30 1931520000
7	45.72	1.800	24 1931530000
8	53.34	2.100	24 1931540000
9	60.96	2.400	18 1931550000
10	68.58	2.700	18 1931570000
11	76.20	3.000	18 1931580000
12	83.82	3.300	12 1931590000

**Plug-in connector, pitch 7.62 mm**  
**BV/SV 7.62 series - connection up to 6 mm<sup>2</sup>**

**SV 7.62HP/./270MF**

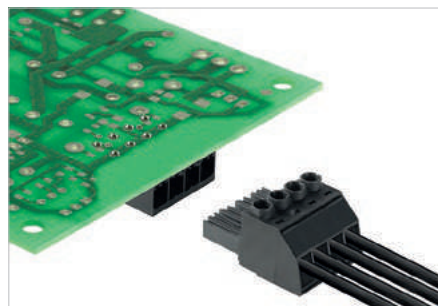

Male header with 180° outlet direction for 400 V TNC(S) systems. UL approval for 600 V in acc. with UL61800-5-1 / UL840. The pin arrangement ensures more than 3 mm of touch-safety in acc. with IEC 61800-5-1.

Maximum connection and operating reliability thanks to: derating up to 125°C, pin arrangement that prevents wrong connections or incorrect wiring, unique coding diversity, additional fastening.

Variants: flange, screw flange and middle flange fastening.

**Product data**

IEC: 1000 V / 57 A  
 UL: 300 V / 40.5 A



For additional articles and information, refer to [catalog.weidmueller.com](http://catalog.weidmueller.com)

**Note:**

- Additional colours on request
- Rated current related to rated cross-section & min. No. of poles.
- P on drawing = pitch
- Rated data refer only to the component itself. Clearance and creepage distances to other components are to be designed in accordance with the relevant application standards.
- MFX and MSFX: X= Position of the middle flange e.g. MF2, MSF3

**SV 7.62HP/./270MF2**



**Dimensioned drawing**

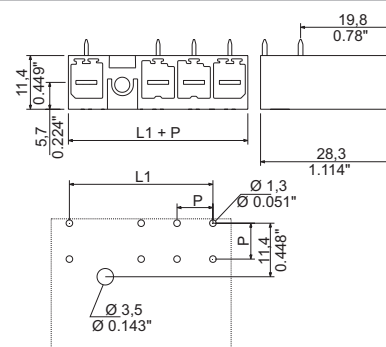

**Technical data**

**In compliance with IEC 60664-1 / IEC 61984**

Clamping range, max.			
<b>Solid core H05(07) V-U</b>			
Stranded H07 V-R			
Flexible H05(07) V-K			
Flexible with ferrule			
Ferrule with plastic collar			
Stripping length			
Screwdriver blade	mm		
According to norm			
Tightening torque range			
<b>Rated current, max.</b>	<b>A</b>	<b>57</b>	<b>41</b>
At ambient temperature		20°C	40°C
For conductor cross-section			
Overtoltage category		III	III II
Pollution severity		3	2 2
<b>Rated voltage</b>	<b>V</b>	<b>630</b>	<b>630 1000</b>
Rated impulse voltage	kV	6	6 6
<b>UL / CUL (Use Group)</b>		<b>B</b>	<b>C D</b>
<b>Rated voltage</b>	<b>V</b>	<b>300</b>	<b>300 600</b>
<b>Rated current</b>	<b>A</b>	<b>40.5</b>	<b>40.5 5</b>
<b>AWG conductor</b>	<b>AWG</b>		<b>-</b>
<b>CSA (Use Group)</b>		<b>B</b>	<b>C D</b>
Rated voltage	V	300	300 600
Rated current	A	35	35 5
AWG conductor	AWG		-
<b>General data</b>			
Type of insulation material		PA GF	
UL 94 flammability rating		V-0	
Contact base material		Copper alloy	
Material of contact surface		tinned	
Pin dimensions = d	mm	0.8 x 1.0	
Solder eyelet Ø = D	mm	1.3	
Solder eyelet Ø tolerance	mm	+ 0,1	

**Accessories**

**Note:** Refer to the Accessories chapter for additional accessories.

Coding	Order No.
BV/SV 7.62HP KO	1937590000

**Ordering data**

<b>Solder pin length</b>		3.5 mm		
<b>Colour</b>		Black		
<b>Pitch</b>		7.62 mm		
Pol.	L1	(inch)	Qty.	Order No.
2	15.24	0.600	78	1048370000
3	22.86	0.900	60	1048450000
4	30.48	1.200	48	1464340000
5	38.10	1.500	36	1464350000
6	45.72	1.800	30	1543250000



SV 7.62HP/./270MF3



Dimensioned drawing

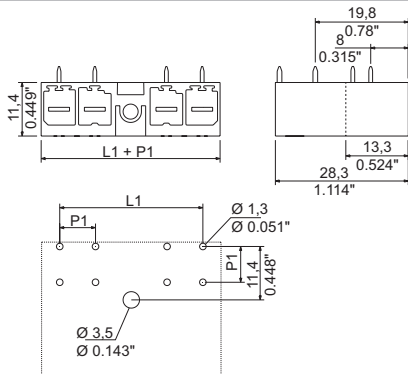

Ordering data

Solder pin length		3.5 mm		
Colour		Black		
Pitch		7.62 mm		
Pol.	L1	(inch)	Qty.	Order No.
3	22.86	0.900	60	1048460000
4	30.48	1.200	48	1048550000
5	38.10	1.500	36	1048640000
6	45.72	1.800	30	1543260000

SV 7.62HP/./270MF4



Dimensioned drawing

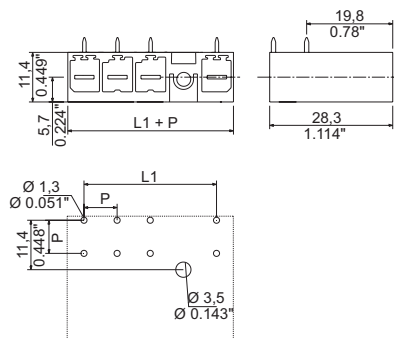

Ordering data

Solder pin length		3.5 mm		
Colour		Black		
Pitch		7.62 mm		
Pol.	L1	(inch)	Qty.	Order No.
4	30.48	1.200	48	1464360000
5	38.10	1.500	36	1048650000
6	45.72	1.800	30	1048740000

**Plug-in connector, pitch 7.62 mm**  
**BV/SV 7.62 series - connection up to 6 mm<sup>2</sup>**

**SVD 7.62HP../270**

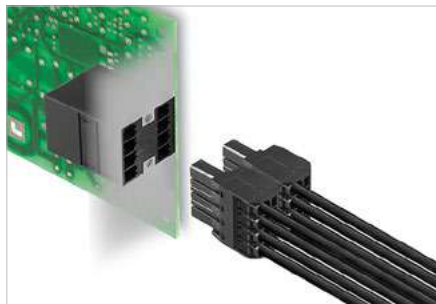

Double-row high-current, high-performance pin headers, with or without flange, for fast, tool-free locking. Optimised for "book-size modules" measuring 50 mm wide and above. With integrated mounting option for mounting to the housing wall. Exceptional reliability and operational safety thanks to 100% failsafe mating profile, unique coding and optional additional screw mounting in the flange.

**Technical data**

**In compliance with IEC 60664-1 / IEC 61984**

Clamping range, max.			
<b>Solid core H05(07) V-U</b>			
Stranded H07 V-R			
Flexible H05(07) V-K			
Flexible with ferrule			
Ferrule with plastic collar			
Stripping length			
Screwdriver blade	mm		
According to norm			
Tightening torque range			
<b>Rated current, max.</b>	<b>A</b>	<b>47</b>	<b>42</b>
At ambient temperature		20°C	40°C
For conductor cross-section			
Overtoltage category		III	III II
Pollution severity		3	2 2
<b>Rated voltage</b>	<b>V</b>	<b>630</b>	<b>630 1000</b>
Rated impulse voltage	kV	6	6 6
<b>UL / CUL (Use Group)</b>	<b>B C D</b>		
<b>Rated voltage</b>	<b>V</b>	<b>300</b>	<b>300 600</b>
<b>Rated current</b>	<b>A</b>	<b>30</b>	<b>30 5</b>
<b>AWG conductor</b>	<b>AWG</b>	-	
<b>CSA (Use Group)</b>	<b>B C D</b>		
Rated voltage	V	300	300 300
Rated current	A		5
AWG conductor	AWG	-	
<b>General data</b>			
Type of insulation material		PA GF	
UL 94 flammability rating		V-0	
Contact base material		Copper alloy	
Material of contact surface		tinned	
Pin dimensions = d	mm	0.8 x 1.0	
Solder eyelet Ø = D	mm	1.4	
Solder eyelet Ø tolerance	mm	+ 0,1	

**Product data**

IEC: 1000 V / 47 A  
 UL: 300 V / 30 A



For additional articles and information, refer to [catalog.weidmueller.com](http://catalog.weidmueller.com)

**Note:**

- Additional colours on request
- Rated current related to rated cross-section & min. No. of poles.
- P on drawing = pitch
- Rated data refer only to the component itself. Clearance and creepage distances to other components are to be designed in accordance with the relevant application standards.

**SVD 7.62HP../270G**



**Dimensioned drawing**

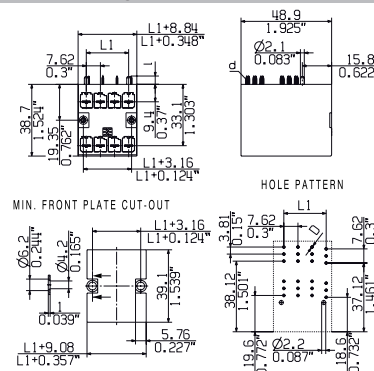

**Accessories**

**Note:** Refer to the Accessories chapter for additional accessories.

Coding	Order No.
BV/SV 7.62HP KO	1937590000



**Ordering data**

<b>Solder pin length</b>		3.2 mm		
<b>Colour</b>		Black		
<b>Pitch</b>		7.62 mm		
Pol.	L1	(inch)	Qty.	Order No.
4	7.62	0.300	60	1543290000
6	15.24	0.600	42	1543310000
8	22.86	0.900	30	1543320000
10	30.48	1.200	24	1543330000
12	38.10	1.500	21	1543340000

SVD 7.62HP/./270F



Dimensioned drawing

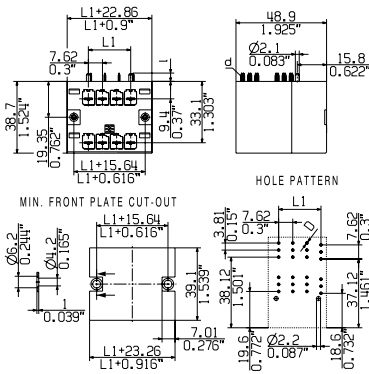

Ordering data

Solder pin length	3.2 mm			
Colour	Black			
Pitch	7.62 mm			
Pol.	L1	(inch)	Qty.	Order No.
4	7.62	0.300	33	1523940000
6	15.24	0.600	24	1523950000
8	22.86	0.900	21	1523970000
10	30.48	1.200	18	1523980000
12	38.10	1.500	15	1523990000

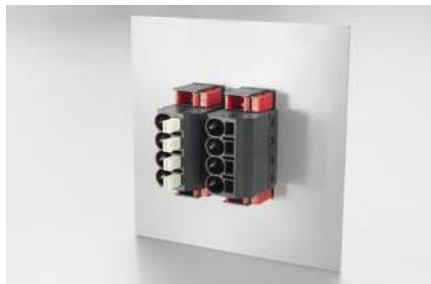
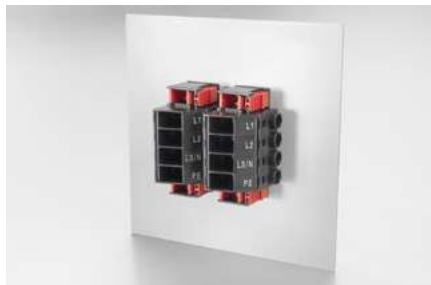
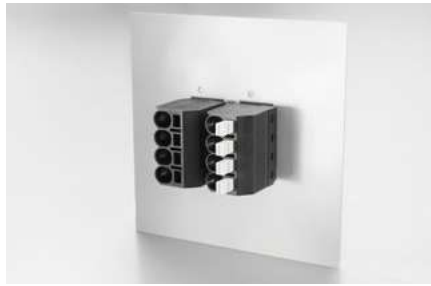

**Plug-in connector, pitch 7.62 mm**  
**BV/SV 7.62 series - connection up to 6 mm<sup>2</sup>**

**SVZ 7.62HP/./180**

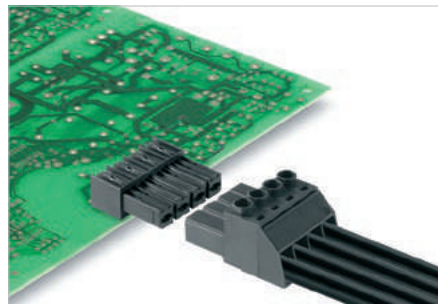

Male plug in 180° outlet direction with clamping yoke screw connection for TNC (S) systems. Also perfect for finger-safe solutions involving inverse voltages. Meets the requirements of UL1059 for 600 V Use Group C. The mating profile ensures touch-safety of > 3 mm in accordance with IEC 61800-5-1.

Maximum operational reliability: with a derating up to 125°C, a mating profile that can only be plugged in correct, and unique coding capability.

- Available with a flange (F) and screw flange (SF).

**Technical data**

In compliance with IEC 60664-1 / IEC 61984			
Clamping range, max.	mm <sup>2</sup>	0.2...6	
<b>Solid core H05(07) V-U</b>	<b>mm<sup>2</sup></b>	<b>0.2...6</b>	
Stranded H07 V-R			
Flexible H05(07) V-K	mm <sup>2</sup>	0.5...10	
Flexible with ferrule	mm <sup>2</sup>	0.25...6	
Ferrule with plastic collar	mm <sup>2</sup>	0.25...6	
Stripping length	mm	12	
Screwdriver blade	mm	0.6 x 3.5	
According to norm			
Tightening torque range	Nm	0.5...0.6	
<b>Rated current, max.</b>	<b>A</b>	<b>57</b>	<b>41</b>
At ambient temperature		20°C	40°C
For conductor cross-section	mm <sup>2</sup>	6	
Overvoltage category		III	II
Pollution severity		3	2
<b>Rated voltage</b>	<b>V</b>	<b>800</b>	<b>1000</b>
Rated impulse voltage	kV	8	6
<b>UL / CUL (Use Group)</b>		<b>B</b>	<b>C</b>
<b>Rated voltage</b>	<b>V</b>	<b>600</b>	<b>600</b>
<b>Rated current</b>	<b>A</b>	<b>42</b>	<b>5</b>
<b>AWG conductor</b>	<b>AWG</b>	<b>24-8</b>	
<b>CSA (Use Group)</b>		<b>B</b>	<b>C</b>
Rated voltage	V	600	600
Rated current	A	35	5
AWG conductor	AWG	24-10	
General data			
Type of insulation material		PA GF	
UL 94 flammability rating		V-0	
Contact base material		Copper alloy	
Material of contact surface		tinned	
Pin dimensions = d	mm		
Solder eyelet Ø = D	mm		
Solder eyelet Ø tolerance	mm		

**Product data**

IEC: 1000 V / 57 A / 0.2 - 10 mm<sup>2</sup>  
 UL: 600 V / 42 A / AWG 24 - 8



For additional articles and information, refer to [catalog.weidmuller.com](http://catalog.weidmuller.com)

**Note:**

- Additional colours on request
- Rated current related to rated cross-section & min. No. of poles.
- Wire end ferrule without plastic collar to DIN 46228/1
- Wire end ferrule with plastic collar to DIN 46228/4
- P on drawing = pitch
- Rated data refer only to the component itself. Clearance and creepage distances to other components are to be designed in accordance with the relevant application standards.

**SVZ 7.62HP/./180**



**Dimensioned drawing**

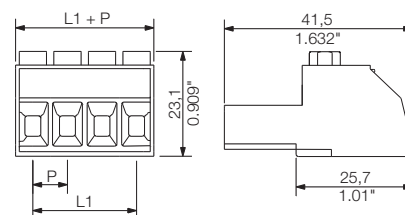

**Ordering data**

Solder pin length				
Colour				Black
Pitch 7.62 mm				
Pol.	L1	(inch)	Qty.	Order No.
2	7.62	0.300	100	1931620000
3	15.24	0.600	100	1931630000
4	22.86	0.900	100	1931640000
5	30.48	1.200	50	1931660000
6	38.10	1.500	50	1931670000
7	45.72	1.800	50	1931680000

**Accessories**

**Note:** Refer to the Accessories chapter for additional accessories.

Coding	Order No.
BV/SV 7.62HP K0	1937590000
Strain relief	
BV/SV 7.62HP/02 ZE GR	1937550000
BV/SV 7.62HP/04 ZE GR	1937560000
Screwdriver	
SDS 0.8X4.5X125	9009020000
Crosshead screwdriver	
SDK PH1	9008480000

**Representative deratings curve**

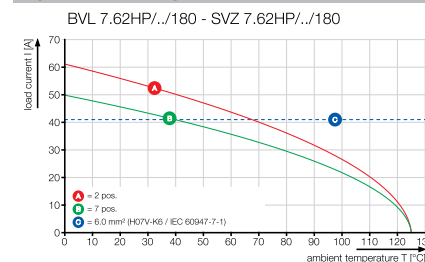

SVZ 7.62HP../180F



Dimensioned drawing

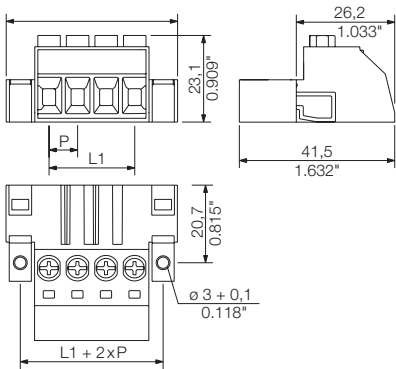

Ordering data

Solder pin length					
Colour					Black
Pitch 7.62 mm					
Pol.	L1	(inch)	Qty.	Order No.	
2	7.62	0.300	100	1931740000	
3	15.24	0.600	100	1931760000	
4	22.86	0.900	100	1931820000	
5	30.48	1.200	50	1931840000	
6	38.10	1.500	50	1931850000	
7	45.72	1.800	50	1931860000	

SVZ 7.62HP../180SF



Dimensioned drawing

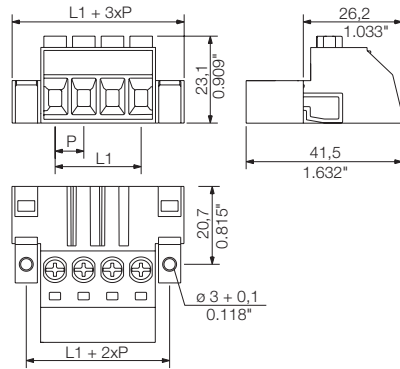

Ordering data

Solder pin length					
Colour					Black
Pitch 7.62 mm					
Pol.	L1	(inch)	Qty.	Order No.	
2	7.62	0.300	100	1931960000	
3	15.24	0.600	100	1931970000	
4	22.86	0.900	100	1931980000	
5	30.48	1.200	50	1931990000	
6	38.10	1.500	50	1932000000	
7	45.72	1.800	50	1932010000	



Additional deratings curves

BVZ 7.62HP../180 - SVZ 7.62HP../180

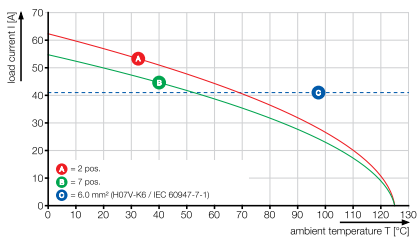

**Plug-in connector, pitch 7.62 mm**  
**BV/SV 7.62 series - connection up to 6 mm<sup>2</sup>**

**SVZ 7.62HP../180FC**

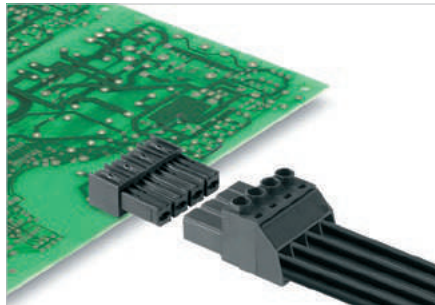

Male plug in 180° outlet direction with clamping yoke screw connection for TNC (S) systems. Also perfect for finger-safe solutions involving inverse voltages. Meets the requirements of UL1059 for 600 V Use Group C. The mating profile ensures touch-safety of > 3 mm in accordance with IEC 61800-5-1.

Maximum operational reliability: with a derating up to 125°C, a mating profile that can only be plugged in correct, and unique coding capability.

- Available with a flange (FL) and a screw flange (SFC).

**Product data**

IEC: 1000 V / 57 A / 0.2 - 10 mm<sup>2</sup>  
 UL: 600 V / 42 A / AWG 24 - 8



For additional articles and information, refer to [catalog.weidmuller.com](http://catalog.weidmuller.com)

**Note:**

- Additional colours on request
- Rated current related to rated cross-section & min. No. of poles.
- Wire end ferrule without plastic collar to DIN 46228/1
- Wire end ferrule with plastic collar to DIN 46228/4
- P on drawing = pitch
- Rated data refer only to the component itself. Clearance and creepage distances to other components are to be designed in accordance with the relevant application standards.

**SVZ 7.62HP../180FC**



**Dimensioned drawing**

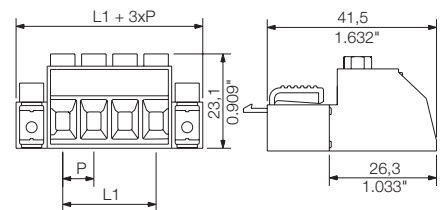

**Technical data**

In compliance with IEC 60664-1 / IEC 61984			
Clamping range, max.	mm <sup>2</sup>	0.2...6	
<b>Solid core H05(07) V-U</b>	<b>mm<sup>2</sup></b>	<b>0.2...6</b>	
Stranded H07 V-R			
Flexible H05(07) V-K	mm <sup>2</sup>	0.5...10	
Flexible with ferrule	mm <sup>2</sup>	0.25...6	
Ferrule with plastic collar	mm <sup>2</sup>	0.25...6	
Stripping length	mm	12	
Screwdriver blade	mm	0.6 x 3.5	
According to norm			
Tightening torque range	Nm	0.5...0.6	
<b>Rated current, max.</b>	<b>A</b>	<b>57</b>	<b>41</b>
At ambient temperature		20°C	40°C
For conductor cross-section	mm <sup>2</sup>	6	
Overvoltage category		III	III II
Pollution severity		3	2 2
<b>Rated voltage</b>	<b>V</b>	<b>800</b>	<b>1000 1000</b>
Rated impulse voltage	kV	8	8 6
<b>UL / CUL (Use Group)</b>		<b>B</b>	<b>C D</b>
<b>Rated voltage</b>	<b>V</b>	<b>600</b>	<b>600 600</b>
<b>Rated current</b>	<b>A</b>	<b>42</b>	<b>42 5</b>
<b>AWG conductor</b>	<b>AWG</b>	<b>24-8</b>	
<b>CSA (Use Group)</b>		<b>B</b>	<b>C D</b>
Rated voltage	V	600	600 600
Rated current	A	35	35 5
AWG conductor	AWG	24-10	
General data			
Type of insulation material		PA GF	
UL 94 flammability rating		V-0	
Contact base material		Copper alloy	
Material of contact surface		tinned	
Pin dimensions = d	mm		
Solder eyelet Ø = D	mm		
Solder eyelet Ø tolerance	mm		

**Accessories**

**Note:** Refer to the Accessories chapter for additional accessories.

Coding	Order No.
BV/SV 7.62HP K0	1937590000
<b>Strain relief</b>	
BV/SV 7.62HP/02 ZE GR	1937550000
BV/SV 7.62HP/04 ZE GR	1937560000
<b>Screwdriver</b>	
SDS 0.8X4.5X125	9009020000
<b>Crosshead screwdriver</b>	
SDK PH1	9008480000

**Ordering data**

Solder pin length				
Colour	Black			
Pitch	7.62 mm			
Pol.	L1	(inch)	Qty.	Order No.
2	7.62	0.300	100	1950880000
3	15.24	0.600	100	1950890000
4	22.86	0.900	100	1950900000
5	30.48	1.200	50	1950910000
6	38.10	1.500	50	1950920000
7	45.72	1.800	50	1950930000

**Representative deratings curve**

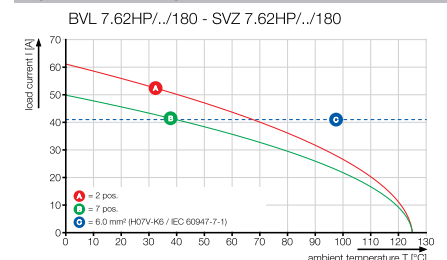

SVZ 7.62HP../180SFC



Dimensioned drawing

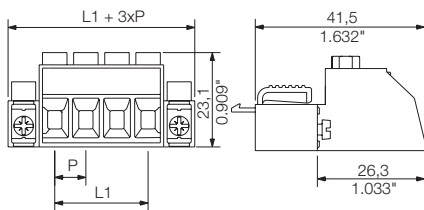

Ordering data

Solder pin length				
Colour		Black		
Pitch		7.62 mm		
Pol.	L1	(inch)	Qty.	Order No.
2	7.62	0.300	100	1950990000
3	15.24	0.600	100	1951000000
4	22.86	0.900	100	1951010000
5	30.48	1.200	50	1951020000
6	38.10	1.500	50	1951030000
7	45.72	1.800	50	1951050000



Additional deratings curves

BVZ 7.62HP../180 - SVZ 7.62HP../180

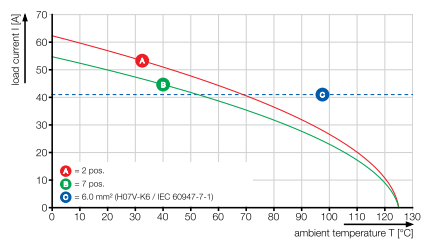

**Plug-in connector, pitch 7.62 mm**  
**BV/SV 7.62 series - connection up to 6 mm<sup>2</sup>**

**SVZ 7.62HP../180FI**

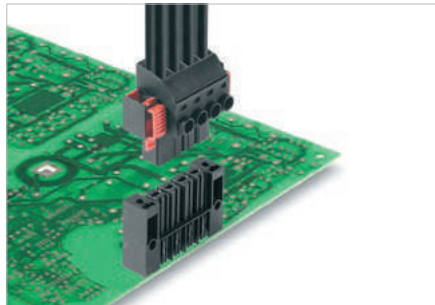

Male plug in 180° outlet direction with clamping yoke screw connection for TNC (S) systems. Also perfect for finger-safe solutions involving inverse voltages for board-to-wire connections. Meets the requirements of UL1059 for 600 V Use Group C. The mating profile ensures touch-safety of > 3 mm in accordance with IEC 61800-5-1.

Maximum operational reliability: with a derating up to 125°C, a mating profile that can only be plugged in correct, and unique coding capability.

Variants: flange and screw flange mountings.

- Available with a flange (F) and a screw flange (SFI).

**Product data**

IEC: 1000 V / 57 A / 0.2 - 10 mm<sup>2</sup>  
 UL: 600 V / 42 A / AWG 24 - 8



For additional articles and information, refer to [catalog.weidmuller.com](http://catalog.weidmuller.com)

**Note:**

- Additional colours on request
- Rated current related to rated cross-section & min. No. of poles.
- Wire end ferrule without plastic collar to DIN 46228/1
- Wire end ferrule with plastic collar to DIN 46228/4
- P on drawing = pitch
- Rated data refer only to the component itself. Clearance and creepage distances to other components are to be designed in accordance with the relevant application standards.

**SVZ 7.62HP../180FI**



**Dimensioned drawing**

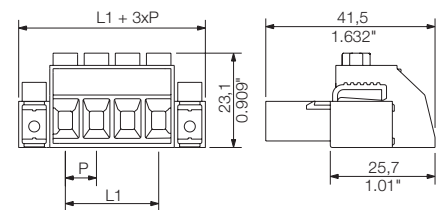

**Technical data**

In compliance with IEC 60664-1 / IEC 61984			
Clamping range, max.	mm <sup>2</sup>	0.2...6	
<b>Solid core H05(07) V-U</b>	<b>mm<sup>2</sup></b>	<b>0.2...6</b>	
Stranded H07 V-R			
Flexible H05(07) V-K	mm <sup>2</sup>	0.5...10	
Flexible with ferrule	mm <sup>2</sup>	0.25...6	
Ferrule with plastic collar	mm <sup>2</sup>	0.25...6	
Stripping length	mm	12	
Screwdriver blade	mm	0.6 x 3.5	
According to norm			
Tightening torque range	Nm	0.5...0.6	
<b>Rated current, max.</b>	<b>A</b>	<b>57</b>	<b>41</b>
At ambient temperature		20°C	40°C
For conductor cross-section	mm <sup>2</sup>	6	
Overvoltage category		III	III II
Pollution severity		3	2 2
<b>Rated voltage</b>	<b>V</b>	<b>800</b>	<b>1000 1000</b>
Rated impulse voltage	kV	8	8 6
<b>UL / CUL (Use Group)</b>		<b>B</b>	<b>C D</b>
<b>Rated voltage</b>	<b>V</b>	<b>600</b>	<b>600 600</b>
<b>Rated current</b>	<b>A</b>	<b>42</b>	<b>42 5</b>
<b>AWG conductor</b>	<b>AWG</b>	<b>24-8</b>	
<b>CSA (Use Group)</b>		<b>B</b>	<b>C D</b>
Rated voltage	V	600	600 600
Rated current	A	35	35 5
AWG conductor	AWG	24-10	
General data			
Type of insulation material		PA GF	
UL 94 flammability rating		V-0	
Contact base material		Copper alloy	
Material of contact surface		tinned	
Pin dimensions = d	mm		
Solder eyelet Ø = D	mm		
Solder eyelet Ø tolerance	mm		

**Accessories**

**Note:** Refer to the Accessories chapter for additional accessories.

Coding		Order No.
	BV/SV 7.62HP K0	1937590000
<b>Strain relief</b>		
	BV/SV 7.62HP/02 ZE GR	1937550000
	BV/SV 7.62HP/04 ZE GR	1937560000
<b>Screwdriver</b>		
	SDS 0.8X4.5X125	9009020000
<b>Crosshead screwdriver</b>		
	SDK PH1	9008480000

**Ordering data**

Solder pin length					
Colour					Black
Pitch 7.62 mm					
Pol.	L1	(inch)	Qty.	Order No.	
2	7.62	0.300	100	1932070000	
3	15.24	0.600	100	1932080000	
4	22.86	0.900	100	1932090000	
5	30.48	1.200	50	1932100000	
6	38.10	1.500	50	1932110000	
7	45.72	1.800	50	1932120000	

**Representative deratings curve**

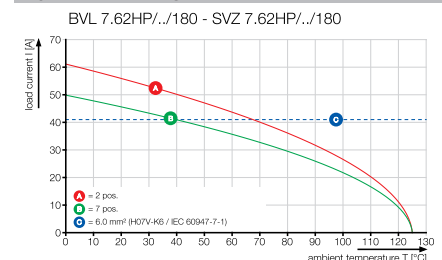



SVZ 7.62HP../180SFI



Dimensioned drawing

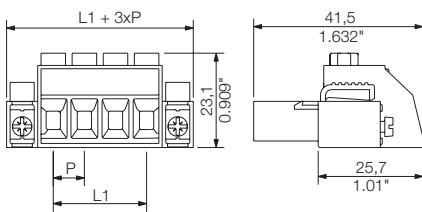

Ordering data

Solder pin length				
Colour		Black		
Pitch		7.62 mm		
Pol.	L1	(inch)	Qty.	Order No.
2	7.62	0.300	100	1932180000
3	15.24	0.600	100	1932190000
4	22.86	0.900	100	1932200000
5	30.48	1.200	50	1932210000
6	38.10	1.500	50	1932220000
7	45.72	1.800	50	1932230000



Additional deratings curves

BVZ 7.62HP../180 - SVZ 7.62HP../180

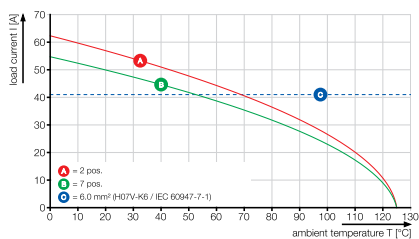

**Plug-in connector, pitch 7.62 mm**  
**BV/SV 7.62 series - connection up to 6 mm<sup>2</sup>**

**SVZ 7.62HP../180SH**

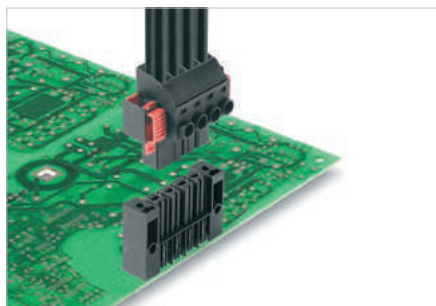

Male plug in 180° outlet direction with clamping yoke screw connection and additional shield connection for TNC (S) systems. Also perfect for finger-safe solutions involving inverse voltages. Meets the requirements of UL1059 for 600 V Use Group C. The mating profile ensures touch-safety of > 3 mm in accordance with IEC 61800-5-1.

Maximum operational reliability with a derating up to 125°C, a mating profile that can only be plugged in correct, and unique coding capability.

- Available with shield in three different orientations.

**Technical data**

In compliance with IEC 60664-1 / IEC 61984			
Clamping range, max.	mm <sup>2</sup>	0.2...6	
<b>Solid core H05(07) V-U</b>	<b>mm<sup>2</sup></b>	<b>0.2...6</b>	
Stranded H07 V-R			
Flexible H05(07) V-K	mm <sup>2</sup>	0.5...10	
Flexible with ferrule	mm <sup>2</sup>	0.25...6	
Ferrule with plastic collar	mm <sup>2</sup>	0.25...6	
Stripping length	mm	12	
Screwdriver blade	mm	0.6 x 3.5	
According to norm			
Tightening torque range	Nm	0.5...0.6	
<b>Rated current, max.</b>	<b>A</b>	<b>57</b>	<b>41</b>
At ambient temperature		20°C	40°C
For conductor cross-section	mm <sup>2</sup>	6	
Overvoltage category		III	III II
Pollution severity		3	2 2
<b>Rated voltage</b>	<b>V</b>	<b>800</b>	<b>1000 1000</b>
Rated impulse voltage	kV	8	8 6
<b>UL / CUL (Use Group)</b>		<b>B</b>	<b>C D</b>
<b>Rated voltage</b>	<b>V</b>	<b>600</b>	<b>600 600</b>
<b>Rated current</b>	<b>A</b>	<b>42</b>	<b>42 5</b>
<b>AWG conductor</b>	<b>AWG</b>	<b>24-8</b>	
<b>CSA (Use Group)</b>		<b>B</b>	<b>C D</b>
Rated voltage	V	600	600 600
Rated current	A	35	35 5
AWG conductor	AWG	24-10	
General data			
Type of insulation material		PA GF	
UL 94 flammability rating		V-0	
Contact base material		Copper alloy	
Material of contact surface		tinned	
Pin dimensions = d	mm		
Solder eyelet Ø = D	mm		
Solder eyelet Ø tolerance	mm		

**Product data**

IEC: 1000 V / 57 A / 0.2 - 10 mm<sup>2</sup>  
 UL: 600 V / 42 A / AWG 24 - 8



For additional articles and information, refer to [catalog.weidmuller.com](http://catalog.weidmuller.com)

**Note:**

- Additional colours on request
- Rated current related to rated cross-section & min. No. of poles.
- Wire end ferrule without plastic collar to DIN 46228/1
- Wire end ferrule with plastic collar to DIN 46228/4
- P on drawing = pitch
- Rated data refer only to the component itself. Clearance and creepage distances to other components are to be designed in accordance with the relevant application standards.

**SVZ 7.62HP../180SH180**



**Dimensioned drawing**

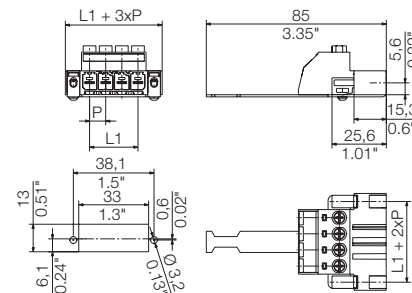

FRONT PLATE CUT-OUT

**Ordering data**

Solder pin length				
Colour	Black			
Pitch	7.62 mm			
Pol.	L1	(inch)	Qty.	Order No.
3	15.24	0.600	50	1932460000
4	22.86	0.900	25	1932470000
5	30.48	1.200	25	1932480000
6	38.10	1.500	25	1932490000

**Accessories**

**Note:** Refer to the Accessories chapter for additional accessories.

Coding	Order No.
BV/SV 7.62HP K0	1937590000
Screwdriver	
SDS 0.8X4.5X125	9009020000
Crosshead screwdriver	
SDK PH1	9008480000

**Representative deratings curve**

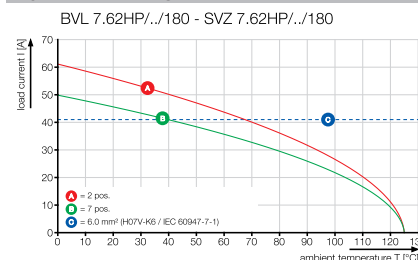

## SVZ 7.62HP../180SH C

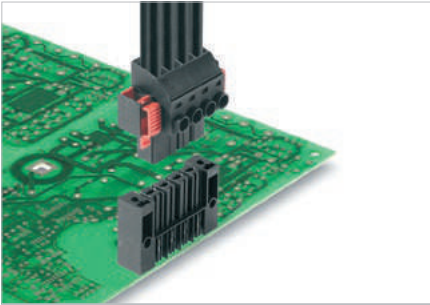

Male plug in 180° outlet direction with clamping yoke screw connection and additional shield connection for TNC (S) systems. Also perfect for finger-safe solutions involving inverse voltages. Meets the requirements of UL1059 for 600 V Use Group C. The mating profile ensures touch-safety of > 3 mm in accordance with IEC 61800-5-1.

Maximum operational reliability with a derating up to 125°C, a mating profile that can only be plugged in correct, and unique coding capability.

- Available with shield in three different orientations.

## Product data

IEC: 1000 V / 57 A / 0.2 - 10 mm<sup>2</sup>  
UL: 600 V / 42 A / AWG 24 - 8



For additional articles and information, refer to [catalog.weidmuller.com](http://catalog.weidmuller.com)

### Note:

- Additional colours on request
- Rated current related to rated cross-section & min. No. of poles.
- Wire end ferrule without plastic collar to DIN 46228/1
- Wire end ferrule with plastic collar to DIN 46228/4
- P on drawing = pitch
- Rated data refer only to the component itself. Clearance and creepage distances to other components are to be designed in accordance with the relevant application standards.

## SVZ 7.62HP../180SH180C



### Dimensioned drawing

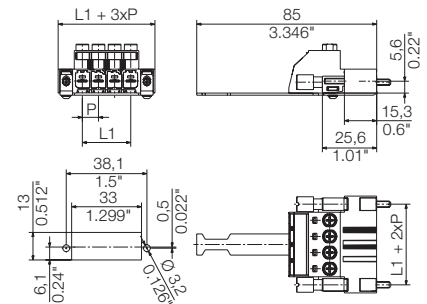

FRONT PLATE CUT-OUT

## Technical data

### In compliance with IEC 60664-1 / IEC 61984

Clamping range, max.	mm <sup>2</sup>	0.2...6
<b>Solid core H05(07) V-U</b>	<b>mm<sup>2</sup></b>	<b>0.2...6</b>
Stranded H07 V-R		
Flexible H05(07) V-K	mm <sup>2</sup>	0.5...10
Flexible with ferrule	mm <sup>2</sup>	0.25...6
Ferrule with plastic collar	mm <sup>2</sup>	0.25...6
Stripping length	mm	12
Screwdriver blade	mm	0.6 x 3.5

According to norm

Tightening torque range	Nm	0.5...0.6
<b>Rated current, max.</b>	<b>A</b>	<b>57 41</b>
At ambient temperature	20°C	40°C
For conductor cross-section	mm <sup>2</sup>	6
Overvoltage category		III III II
Pollution severity		3 2 2

<b>Rated voltage</b>	<b>V</b>	<b>800 1000 1000</b>
Rated impulse voltage	kV	8 8 6

### UL / CUL (Use Group)

<b>Rated voltage</b>	<b>V</b>	<b>600 600 600</b>
<b>Rated current</b>	<b>A</b>	<b>42 42 5</b>
<b>AWG conductor</b>	<b>AWG</b>	<b>24-8</b>

### CSA (Use Group)

Rated voltage	V	600 600 600
Rated current	A	35 35 5
AWG conductor	AWG	24-10

### General data

Type of insulation material	PA GF
UL 94 flammability rating	V-0
Contact base material	Copper alloy
Material of contact surface	tinned
Pin dimensions = d	mm
Solder eyelet Ø = D	mm
Solder eyelet Ø tolerance	mm

## Accessories

Note: Refer to the Accessories chapter for additional accessories.

Coding	Order No.
BV/SV 7.62HP K0	<b>1937590000</b>
<b>Screwdriver</b>	
SDS 0.8X4.5X125	<b>9009020000</b>
<b>Crosshead screwdriver</b>	
SDK PH1	<b>9008480000</b>

## Ordering data

### Solder pin length

Colour	Black			
<b>Pitch</b>	<b>7.62 mm</b>			
Pol.	L1	(inch)	Qty.	Order No.
3	15.24	0.600	50	<b>1951150000</b>
4	22.86	0.900	25	<b>1951160000</b>
5	30.48	1.200	25	<b>1951170000</b>
6	38.10	1.500	25	<b>1951180000</b>

### Representative deratings curve

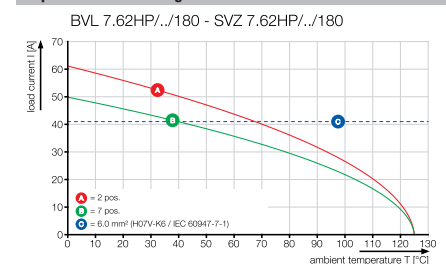

**Plug-in connector, pitch 7.62 mm**  
**BV/SV 7.62 series - connection up to 6 mm<sup>2</sup>**

**SVZ 7.62HP../180SH I**

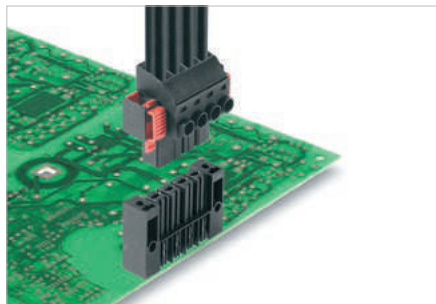

Male plug in 180° outlet direction with clamping yoke screw connection and additional shield connection for TNC (S) systems. Also perfect for finger-safe solutions involving inverse voltages for board-to-wire connections. Meets the requirements of UL1059 for 600 V Use Group C. The mating profile ensures touch-safety of > 3 mm in accordance with IEC 61800-5-1.

Maximum operational reliability with a derating up to 125°C, a mating profile that can only be plugged in correct, and unique coding capability.

- Available with shield in three different orientations.

**Technical data**

In compliance with IEC 60664-1 / IEC 61984			
Clamping range, max.	mm <sup>2</sup>	0.2...6	
<b>Solid core H05(07) V-U</b>	<b>mm<sup>2</sup></b>	<b>0.2...6</b>	
Stranded H07 V-R			
Flexible H05(07) V-K	mm <sup>2</sup>	0.5...10	
Flexible with ferrule	mm <sup>2</sup>	0.25...6	
Ferrule with plastic collar	mm <sup>2</sup>	0.25...6	
Stripping length	mm	12	
Screwdriver blade	mm	0.6 x 3.5	
According to norm			
Tightening torque range	Nm	0.5...0.6	
<b>Rated current, max.</b>	<b>A</b>	<b>57</b>	<b>41</b>
At ambient temperature	20°C	40°C	
For conductor cross-section	mm <sup>2</sup>	6	
Overvoltage category		III	II
Pollution severity		3	2
<b>Rated voltage</b>	<b>V</b>	<b>800</b>	<b>1000</b>
Rated impulse voltage	kV	8	6
<b>UL / CUL (Use Group)</b>		<b>B</b>	<b>C</b>
<b>Rated voltage</b>	<b>V</b>	<b>600</b>	<b>600</b>
<b>Rated current</b>	<b>A</b>	<b>42</b>	<b>5</b>
<b>AWG conductor</b>	<b>AWG</b>	<b>24-8</b>	
<b>CSA (Use Group)</b>		<b>B</b>	<b>C</b>
Rated voltage	V	600	600
Rated current	A	35	5
AWG conductor	AWG	24-10	
<b>General data</b>			
Type of insulation material		PA GF	
UL 94 flammability rating		V-0	
Contact base material		Copper alloy	
Material of contact surface		tinned	
Pin dimensions = d	mm		
Solder eyelet Ø = D	mm		
Solder eyelet Ø tolerance	mm		

**Product data**

IEC: 1000 V / 57 A / 0.2 - 10 mm<sup>2</sup>  
 UL: 600 V / 42 A / AWG 24 - 8



For additional articles and information, refer to [catalog.weidmueller.com](http://catalog.weidmueller.com)

**Note:**

- Additional colours on request
- Rated current related to rated cross-section & min. No. of poles.
- Wire end ferrule without plastic collar to DIN 46228/1
- Wire end ferrule with plastic collar to DIN 46228/4
- P on drawing = pitch
- Rated data refer only to the component itself. Clearance and creepage distances to other components are to be designed in accordance with the relevant application standards.

**SVZ 7.62HP../180SH180I**



**Dimensioned drawing**

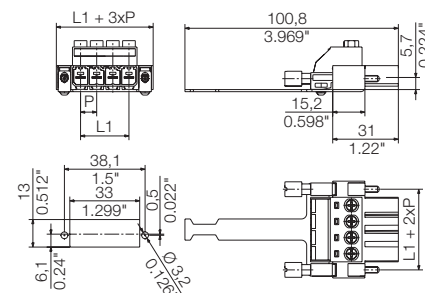

FRONT PLATE CUT-OUT

**Ordering data**

Solder pin length				
Colour	Black			
Pitch	7.62 mm			
Pol.	L1	(inch)	Qty.	Order No.
3	15.24	0.600	50	1932500000
4	22.86	0.900	25	1932510000
5	30.48	1.200	25	1932520000
6	38.10	1.500	25	1932530000

**Accessories**

**Note:** Refer to the Accessories chapter for additional accessories.

Coding	Order No.
BV/SV 7.62HP K0	1937590000
<b>Screwdriver</b>	
SDS 0.8X4.5X125	9009020000
<b>Crosshead screwdriver</b>	
SDK PH1	9008480000

**Representative deratings curve**

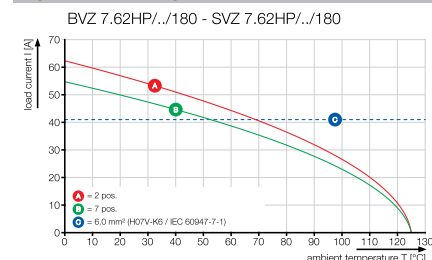



**Plug-in connector, pitch 7.62 mm**  
**BV/SV 7.62 series - connection up to 6 mm<sup>2</sup>**

**SVF 7.62HP../180**

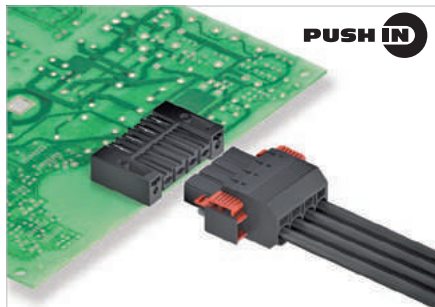

Male plug in 180° outlet direction and "PUSH IN" spring connection for TNC(S) networks. Also perfect for finger-safe solutions involving inverse voltages. Meets the requirements of UL1059 for 600 V Use Group C. The mating profile ensures touch-safety of > 3 mm in accordance with IEC 61800-5-1.

Maximum operational reliability: with a derating up to 125°C, a mating profile that can only be plugged in correct, and unique coding capability.

- Available with a flange (F) and a screw flange (SF).

**Product data**

IEC: 1000 V / 57 A / 0.5 - 10 mm<sup>2</sup>  
 UL: 600 V / 39 A / AWG 24 - 10



For additional articles and information, refer to [catalog.weidmueller.com](http://catalog.weidmueller.com)

**Note:**

- Additional colours on request
- Rated current related to rated cross-section & min. No. of poles.
- Wire end ferrule without plastic collar to DIN 46228/1
- Wire end ferrule with plastic collar to DIN 46228/4
- P on drawing = pitch
- Rated data refer only to the component itself. Clearance and creepage distances to other components are to be designed in accordance with the relevant application standards.

**SVF 7.62HP../180G**



**Dimensioned drawing**

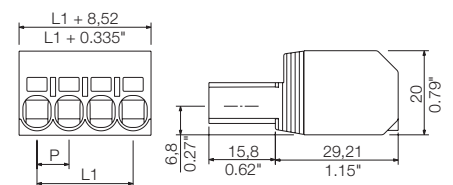

**Technical data**

**In compliance with IEC 60664-1 / IEC 61984**

Clamping range, max.	mm <sup>2</sup>	0.5...10
<b>Solid core H05(07) V-U</b>	<b>mm<sup>2</sup></b>	<b>0.5...6</b>
Stranded H07 V-R		...10
Flexible H05(07) V-K	mm <sup>2</sup>	0.5...10
Flexible with ferrule	mm <sup>2</sup>	1.5...6
Ferrule with plastic collar	mm <sup>2</sup>	1.5...6
Stripping length	mm	12
Screwdriver blade	mm	0.6 x 3.5

According to norm

Tightening torque range			
<b>Rated current, max.</b>	<b>A</b>	<b>57</b>	<b>57</b>
At ambient temperature		20°C	40°C
For conductor cross-section	mm <sup>2</sup>	6	
Overvoltage category		III	III II
Pollution severity		3	2 2
<b>Rated voltage</b>	<b>V</b>	<b>800</b>	<b>800 1000</b>
Rated impulse voltage	kV	8	8 6

**UL / CUL (Use Group)**

<b>Rated voltage</b>	<b>V</b>	<b>600</b>	<b>600</b>	<b>600</b>
<b>Rated current</b>	<b>A</b>	<b>39</b>	<b>39</b>	<b>5</b>
<b>AWG conductor</b>	<b>AWG</b>	<b>24-10</b>		
<b>CSA (Use Group)</b>		<b>B</b>	<b>C</b>	<b>D</b>
Rated voltage	V	600	600	600
Rated current	A	36	36	5
AWG conductor	AWG	24-10		

**General data**

Type of insulation material		PA GF
UL 94 flammability rating		V-0
Contact base material		Copper alloy
Material of contact surface		tinned
Pin dimensions = d	mm	
Solder eyelet Ø = D	mm	
Solder eyelet Ø tolerance	mm	

**Accessories**

**Note:** Refer to the Accessories chapter for additional accessories.

Coding		Order No.
	BV/SV 7.62HP K0	1937590000
<b>Screwdriver</b>		
	SDS 0.8X4.5X125	9009020000
<b>Crimping tool</b>		
	PZ 6/5	9011460000

**Ordering data**

Solder pin length				
Colour	Black			
Pitch	7.62 mm			
Pol.	L1	(inch)	Qty.	Order No.
2	7.62	0.300	95	1060830000
3	15.24	0.600	65	1060840000
4	22.86	0.900	45	1060850000
5	30.48	1.200	40	1060870000
6	38.10	1.500	30	1060880000

**Representative deratings curve**

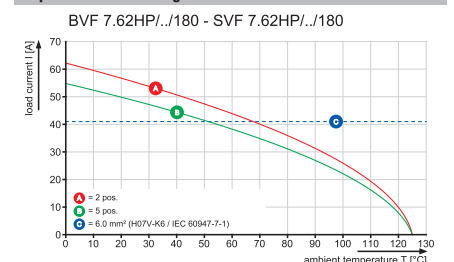

SVF 7.62HP../180F



Dimensioned drawing

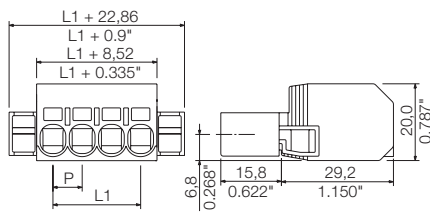

SVF 7.62HP../180SF



Dimensioned drawing

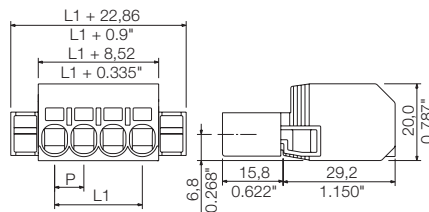

Ordering data

Solder pin length					
Colour					Black
Pitch 7.62 mm					
Pol.	L1	(inch)	Qty.	Order No.	
2	7.62	0.300	50	1060900000	
3	15.24	0.600	40	1060910000	
4	22.86	0.900	30	1060920000	
5	30.48	1.200	25	1060930000	

Ordering data

Solder pin length					
Colour					Black
Pitch 7.62 mm					
Pol.	L1	(inch)	Qty.	Order No.	
2	7.62	0.300	50	1060950000	
3	15.24	0.600	40	1060970000	
4	22.86	0.900	30	1060980000	
5	30.48	1.200	25	1061000000	

**Plug-in connector, pitch 7.62 mm**  
**BV/SV 7.62 series - connection up to 6 mm<sup>2</sup>**

**SVF 7.62HP../180 I**

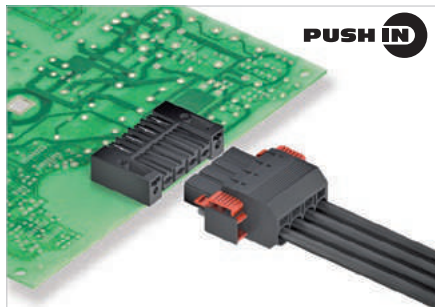

Male plug in 180° outlet direction and "PUSH IN" spring connection for TNC(S) networks. Also perfect for finger-safe solutions involving inverse voltages for board-to-wire connections. Meets the requirements of UL1059 for 600 V Use Group C. The mating profile ensures touch-safety of > 3 mm in accordance with IEC 61800-5-1.

Maximum operational reliability with a derating up to 125°C, a mating profile that can only be plugged in correct, and unique coding capability.

- Available with a flange (FI) and a screw flange (SFI).

**Technical data**

In compliance with IEC 60664-1 / IEC 61984			
Clamping range, max.	mm <sup>2</sup>	0.5...10	
<b>Solid core H05(07) V-U</b>	<b>mm<sup>2</sup></b>	<b>0.5...6</b>	
Stranded H07 V-R		...10	
Flexible H05(07) V-K	mm <sup>2</sup>	0.5...10	
Flexible with ferrule	mm <sup>2</sup>	1.5...6	
Ferrule with plastic collar	mm <sup>2</sup>	1.5...6	
Stripping length	mm	12	
Screwdriver blade	mm	0.6 x 3.5	
According to norm			
Tightening torque range			
<b>Rated current, max.</b>	<b>A</b>	<b>57</b>	<b>57</b>
At ambient temperature		20°C	40°C
For conductor cross-section	mm <sup>2</sup>	6	
Overvoltage category		III	III II
Pollution severity		3	2 2
<b>Rated voltage</b>	<b>V</b>	<b>800</b>	<b>800 1000</b>
Rated impulse voltage	kV	8	8 6
<b>UL / CUL (Use Group)</b>		<b>B</b>	<b>C D</b>
<b>Rated voltage</b>	<b>V</b>	<b>600</b>	<b>600 600</b>
<b>Rated current</b>	<b>A</b>	<b>39</b>	<b>39 5</b>
<b>AWG conductor</b>	<b>AWG</b>	<b>24-10</b>	
<b>CSA (Use Group)</b>		<b>B</b>	<b>C D</b>
Rated voltage	V	600	600 600
Rated current	A	36	36 5
AWG conductor	AWG	24-10	
<b>General data</b>			
Type of insulation material		PA GF	
UL 94 flammability rating		V-0	
Contact base material		Copper alloy	
Material of contact surface		tinned	
Pin dimensions = d	mm		
Solder eyelet Ø = D	mm		
Solder eyelet Ø tolerance	mm		

**Product data**

IEC: 1000 V / 57 A / 0.5 - 10 mm<sup>2</sup>  
 UL: 600 V / 39 A / AWG 24 - 10



For additional articles and information, refer to [catalog.weidmuller.com](http://catalog.weidmuller.com)

**Note:**

- Additional colours on request
- Rated current related to rated cross-section & min. No. of poles.
- Wire end ferrule without plastic collar to DIN 46228/1
- Wire end ferrule with plastic collar to DIN 46228/4
- P on drawing = pitch
- Rated data refer only to the component itself. Clearance and creepage distances to other components are to be designed in accordance with the relevant application standards.

**SVF 7.62HP../180FI**



**Dimensioned drawing**

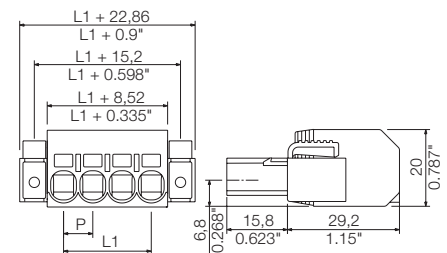

**Accessories**

**Note:** Refer to the Accessories chapter for additional accessories.

Coding	Order No.
BV/SV 7.62HP K0	<b>1937590000</b>
<b>Screwdriver</b>	
SDS 0.8X4.5X125	<b>9009020000</b>
<b>Crimping tool</b>	
PZ 6/5	<b>9011460000</b>

**Ordering data**

Solder pin length				
Colour	Black			
Pitch	7.62 mm			
Pol.	L1	(inch)	Qty.	Order No.
2	7.62	0.300	50	<b>1124750000</b>
3	15.24	0.600	40	<b>1124760000</b>
4	22.86	0.900	30	<b>1124770000</b>
5	30.48	1.200	25	<b>1124780000</b>

**Representative deratings curve**

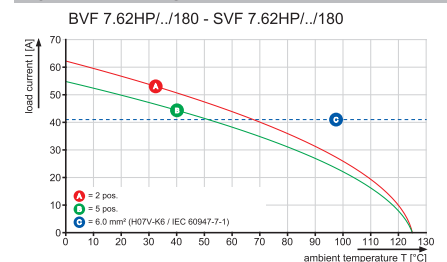



SVF 7.62HP/./180SFI



Dimensioned drawing

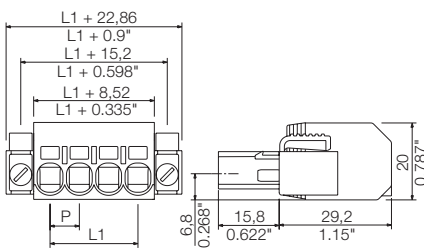

Ordering data

Solder pin length					
Colour					Black
Pitch		7.62 mm			
Pol.	L1	(inch)	Qty.	Order No.	
2	7.62	0.300	50	1124810000	
3	15.24	0.600	40	1124820000	
4	22.86	0.900	30	1124830000	
5	30.48	1.200	25	1124840000	

**Plug-in connector, pitch 7.62 mm**  
**BV/SV 7.62 series - connection up to 6 mm<sup>2</sup>**

**SVF 7.62HP../180MF**

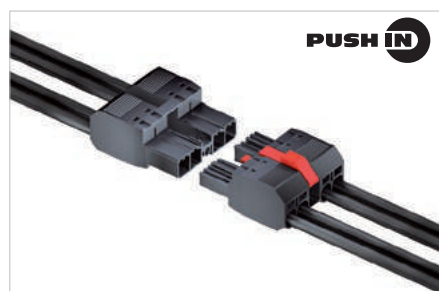

**PUSH IN**

Male plug in 180° outlet direction with "PUSH IN" spring connection for TNC(S) networks. Also perfect for finger-safe solutions involving inverse voltages. Meets the requirements of UL1059 for 600 V Use Group C. The mating profile ensures touch-safety of > 3 mm in accordance with IEC 61800-5-1.

Maximum operational reliability with a derating up to 125°C, a mating profile that can only be plugged in correct, and unique coding capability.

- Middle flange is available in positions 2, 3 and 4.

**Technical data**

In compliance with IEC 60664-1 / IEC 61984			
Clamping range, max.	mm <sup>2</sup>	0.5...10	
<b>Solid core H05(07) V-U</b>	<b>mm<sup>2</sup></b>	<b>0.5...6</b>	
Stranded H07 V-R		...10	
Flexible H05(07) V-K	mm <sup>2</sup>	0.5...10	
Flexible with ferrule	mm <sup>2</sup>	1.5...6	
Ferrule with plastic collar	mm <sup>2</sup>	1.5...6	
Stripping length	mm	12	
Screwdriver blade	mm	0.6 x 3.5	
According to norm			
Tightening torque range			
<b>Rated current, max.</b>	<b>A</b>	<b>57</b>	<b>57</b>
At ambient temperature		20°C	40°C
For conductor cross-section	mm <sup>2</sup>	6	
Overvoltage category		III	III II
Pollution severity		3	2 2
<b>Rated voltage</b>	<b>V</b>	<b>800</b>	<b>800 1000</b>
Rated impulse voltage	kV	8	8 6
<b>UL / CUL (Use Group)</b>		<b>B</b>	<b>C D</b>
<b>Rated voltage</b>	<b>V</b>	<b>600</b>	<b>600 600</b>
<b>Rated current</b>	<b>A</b>	<b>39</b>	<b>39 5</b>
<b>AWG conductor</b>	<b>AWG</b>	<b>24-10</b>	
<b>CSA (Use Group)</b>		<b>B</b>	<b>C D</b>
Rated voltage	V	600	600 600
Rated current	A	36	36 5
AWG conductor	AWG	24-10	
<b>General data</b>			
Type of insulation material		PA GF	
UL 94 flammability rating		V-0	
Contact base material		Copper alloy	
Material of contact surface		tinned	
Pin dimensions = d	mm		
Solder eyelet Ø = D	mm		
Solder eyelet Ø tolerance	mm		

**Product data**

IEC: 1000 V / 57 A / 0.5 - 10 mm<sup>2</sup>  
 UL: 600 V / 39 A / AWG 24 - 10



For additional articles and information, refer to [catalog.weidmuller.com](http://catalog.weidmuller.com)

**Note:**

- Additional colours on request
- Rated current related to rated cross-section & min. No. of poles.
- Wire end ferrule without plastic collar to DIN 46228/1
- Wire end ferrule with plastic collar to DIN 46228/4
- P on drawing = pitch
- Rated data refer only to the component itself. Clearance and creepage distances to other components are to be designed in accordance with the relevant application standards.
- MFX and MSFX: X= Position of the middle flange e.g. MF2, MSF3

**SVF 7.62HP../180MF2**



**Dimensioned drawing**

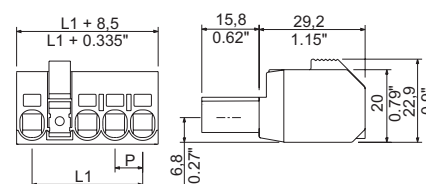

**Accessories**

**Note:** Refer to the Accessories chapter for additional accessories.

Coding	Order No.
BV/SV 7.62HP KO	1937590000
<b>Screwdriver</b>	
SDS 0.8X4.5X125	9009020000
<b>Crimping tool</b>	
PZ 6/5	9011460000

**Ordering data**

Solder pin length				
Colour	Black			
Pitch	7.62 mm			
Pol.	L1	(inch)	Qty.	Order No.
2	15.24	0.600	65	1061020000
3	22.86	0.900	50	1061030000
4	30.48	1.200	40	1430010000
5	38.10	1.500	30	1430020000

**Representative deratings curve**

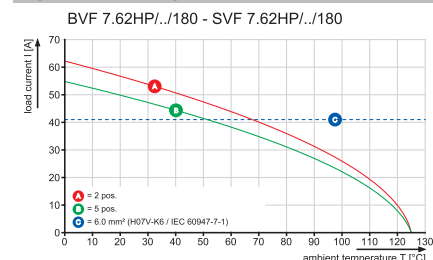

SVF 7.62HP../180MF3



Dimensioned drawing

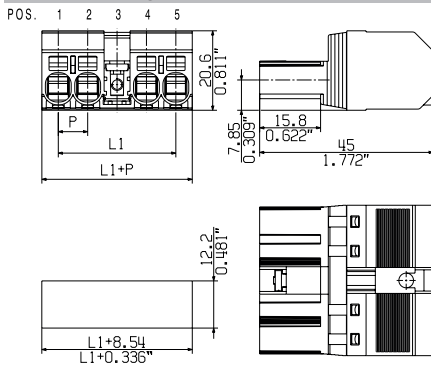

Ordering data

Solder pin length					
Colour					Black
Pitch 7.62 mm					
Pol.	L1	(inch)	Qty.	Order No.	
3	22.86	0.900	50	1061040000	
4	30.48	1.200	40	1061050000	
5	38.10	1.500	30	1061070000	

SVF 7.62HP../180MF4



Dimensioned drawing

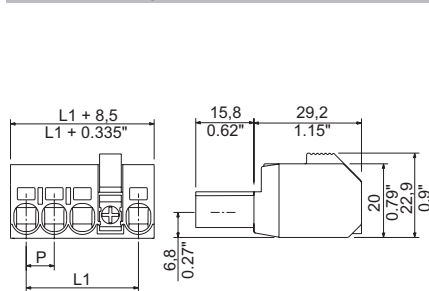

Ordering data

Solder pin length					
Colour					Black
Pitch 7.62 mm					
Pol.	L1	(inch)	Qty.	Order No.	
4	30.48	1.200	10	1430030000	
5	38.10	1.500	30	1061080000	
6	45.72	1.800	25	1061100000	

**Plug-in connector, pitch 7.62 mm**  
**BV/SV 7.62 series - connection up to 6 mm<sup>2</sup>**

**SVF 7.62HP../180MSF**

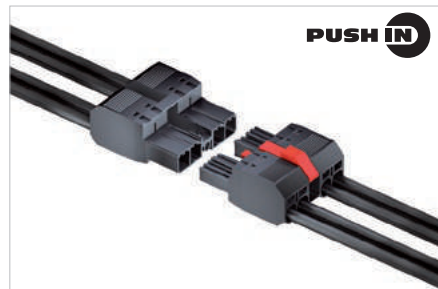

**PUSH IN**

Male plug in 180° outlet direction with "PUSH IN" spring connection for TNC(S) networks. Also perfect for finger-safe solutions involving inverse voltages. Meets the requirements of UL1059 for 600 V Use Group C. The mating profile ensures touch-safety of > 3 mm in accordance with IEC 61800-5-1.

Maximum operational reliability: with a derating up to 125°C, a mating profile that can only be plugged in correct, and unique coding capability.

- Middle flange is available in positions 2, 3 and 4.

**Technical data**

**In compliance with IEC 60664-1 / IEC 61984**

Clamping range, max.	mm <sup>2</sup>	0.5...10
<b>Solid core H05(07) V-U</b>	<b>mm<sup>2</sup></b>	<b>0.5...6</b>
Stranded H07 V-R		...10
Flexible H05(07) V-K	mm <sup>2</sup>	0.5...10
Flexible with ferrule	mm <sup>2</sup>	1.5...6
Ferrule with plastic collar	mm <sup>2</sup>	1.5...6
Stripping length	mm	12
Screwdriver blade	mm	0.6 x 3.5

According to norm

Tightening torque range			
<b>Rated current, max.</b>	<b>A</b>	<b>57</b>	<b>57</b>
At ambient temperature		20°C	40°C
For conductor cross-section	mm <sup>2</sup>	6	
Overvoltage category		III	III II
Pollution severity		3	2 2
<b>Rated voltage</b>	<b>V</b>	<b>800</b>	<b>800 1000</b>
Rated impulse voltage	kV	8	8 6
<b>UL / CUL (Use Group)</b>		<b>B</b>	<b>C D</b>

<b>Rated voltage</b>	<b>V</b>	<b>600</b>	<b>600</b>	<b>600</b>
<b>Rated current</b>	<b>A</b>	<b>39</b>	<b>39</b>	<b>5</b>
<b>AWG conductor</b>	<b>AWG</b>	<b>24-10</b>		
<b>CSA (Use Group)</b>		<b>B</b>	<b>C</b>	<b>D</b>
Rated voltage	V	600	600	600
Rated current	A	36	36	5
AWG conductor	AWG	24-10		

**General data**

Type of insulation material		PA GF
UL 94 flammability rating		V-0
Contact base material		Copper alloy
Material of contact surface		tinned
Pin dimensions = d	mm	
Solder eyelet Ø = D	mm	
Solder eyelet Ø tolerance	mm	

**Product data**

IEC: 1000 V / 57 A / 0.5 - 10 mm<sup>2</sup>  
 UL: 600 V / 39 A / AWG 24 - 10



For additional articles and information, refer to [catalog.weidmuller.com](http://catalog.weidmuller.com)

**Note:**

- Additional colours on request
- Rated current related to rated cross-section & min. No. of poles.
- Wire end ferrule without plastic collar to DIN 46228/1
- Wire end ferrule with plastic collar to DIN 46228/4
- P on drawing = pitch
- Rated data refer only to the component itself. Clearance and creepage distances to other components are to be designed in accordance with the relevant application standards.
- MFX and MSFX: X= Position of the middle flange e.g. MF2, MSF3

**SVF 7.62HP../180MSF2**



**Dimensioned drawing**

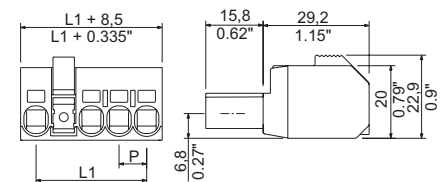

**Accessories**

**Note:** Refer to the Accessories chapter for additional accessories.

Coding		Order No.
	BV/SV 7.62HP KO	1937590000
<b>Screwdriver</b>		
	SDS 0.6X3.5X100	9008330000
	SDIS 0.6X3.5X100	9008390000
<b>Crimping tool</b>		
	PZ 6/5	9011460000

**Ordering data**

<b>Solder pin length</b>				
<b>Colour</b>	<b>Black</b>			
<b>Pitch</b>	<b>7.62 mm</b>			
Pol.	L1	(inch)	Qty.	Order No.
2	15.24	0.600	65	1061110000
3	22.86	0.900	50	1061120000
4	30.48	1.200	40	1430060000
5	38.10	1.500	30	1430070000

**Representative deratings curve**

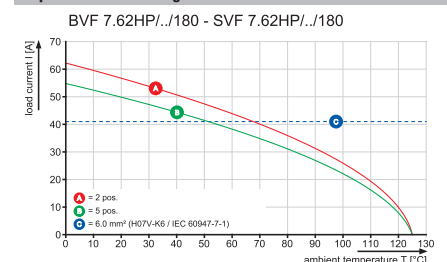

SVF 7.62HP../180MSF3



Dimensioned drawing

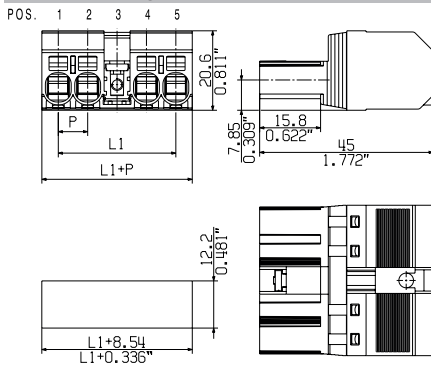

Ordering data

Solder pin length					
Colour					Black
Pitch 7.62 mm					
Pol.	L1	(inch)	Qty.	Order No.	
3	22.86	0.900	50	1061130000	
4	30.48	1.200	40	1061140000	
5	38.10	1.500	30	1061150000	

SVF 7.62HP../180MSF4



Dimensioned drawing

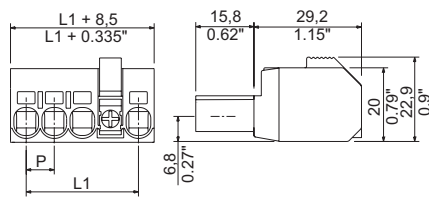

Ordering data

Solder pin length					
Colour					Black
Pitch 7.62 mm					
Pol.	L1	(inch)	Qty.	Order No.	
4	30.48	1.200	40	1430080000	
5	38.10	1.500	30	1061170000	
6	45.72	1.800	25	1061180000	

**Plug-in connector, pitch 7.62 mm**  
**BV/SV 7.62 series - connection up to 6 mm<sup>2</sup>**

**SVF 7.62HP../180**

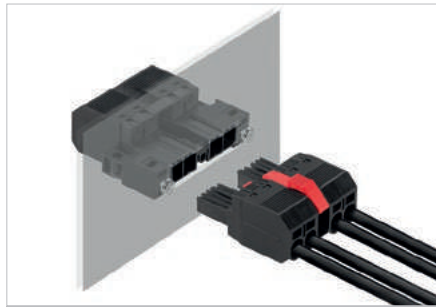

180° inverted male header featuring PUSH IN connection technology for field wiring in 6 mm<sup>2</sup> with a 7.62 pitch as a "three-flange variant" for enclosure feed-throughs. Suitable for enclosures with a max. wall thickness of 2 mm. Also a perfect finger-safe solution for reverse voltages. Meets the requirements of UL1059 600 V Class C and IEC 61800-5-1.

**Technical data**

**In compliance with IEC 60664-1 / IEC 61984**

Clamping range, max.	mm <sup>2</sup>	0.5...10
<b>Solid core H05(07) V-U</b>	<b>mm<sup>2</sup></b>	<b>0.5...6</b>
Stranded H07 V-R		...10
Flexible H05(07) V-K	mm <sup>2</sup>	0.5...10
Flexible with ferrule	mm <sup>2</sup>	1.5...6
Ferrule with plastic collar	mm <sup>2</sup>	1.5...6
Stripping length	mm	12
Screwdriver blade	mm	0.6 x 3.5

According to norm

Tightening torque range			
<b>Rated current, max.</b>	<b>A</b>	<b>57</b>	<b>57</b>
At ambient temperature		20°C	40°C

For conductor cross-section			
Overvoltage category		III	III
Pollution severity		3	2
		2	2

<b>Rated voltage</b>	<b>V</b>	<b>800</b>	<b>800</b>	<b>1000</b>
Rated impulse voltage	kV	8	8	6

<b>UL / CUL (Use Group)</b>	<b>B</b>	<b>C</b>	<b>D</b>
-----------------------------	----------	----------	----------

<b>Rated voltage</b>	<b>V</b>	<b>600</b>	<b>600</b>	<b>600</b>
----------------------	----------	------------	------------	------------

<b>Rated current</b>	<b>A</b>	<b>39</b>	<b>39</b>	<b>5</b>
----------------------	----------	-----------	-----------	----------

<b>AWG conductor</b>	<b>AWG</b>	<b>24-10</b>
----------------------	------------	--------------

<b>CSA (Use Group)</b>	<b>B</b>	<b>C</b>	<b>D</b>
------------------------	----------	----------	----------

Rated voltage	V	600	600	600
---------------	---	-----	-----	-----

Rated current	A	36	36	5
---------------	---	----	----	---

AWG conductor	AWG	24-10
---------------	-----	-------

**General data**

Type of insulation material		PA GF
UL 94 flammability rating		V-0
Contact base material		Copper alloy
Material of contact surface		tinned
Pin dimensions = d	mm	
Solder eyelet Ø = D	mm	
Solder eyelet Ø tolerance	mm	

**Product data**

IEC: 1000 V / 57 A / 0.5 - 10 mm<sup>2</sup>  
 UL: 600 V / 39 A / AWG 24 - 10



For additional articles and information, refer to [catalog.weidmueller.com](http://catalog.weidmueller.com)

**Note:**

- Additional colours on request
- Rated current related to rated cross-section & min. No. of poles.
- Wire end ferrule without plastic collar to DIN 46228/1
- Wire end ferrule with plastic collar to DIN 46228/4
- P on drawing = pitch
- Rated data refer only to the component itself. Clearance and creepage distances to other components are to be designed in accordance with the relevant application standards.
- MFX and MSFX: X= Position of the middle flange e.g. MF2, MSF3

**SVF 7.62HP../180SFMF2**



**Dimensioned drawing**

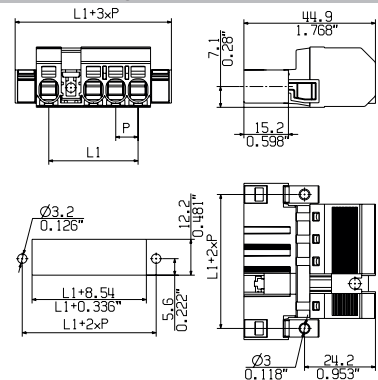

**Ordering data**

<b>Solder pin length</b>			
<b>Colour</b>	<b>Black</b>		
<b>Pitch</b>	<b>7.62 mm</b>		
<b>Pol.</b>	<b>L1</b>	<b>(inch)</b>	<b>Qty.</b>
2	15.24	0.600	40
3	22.86	0.900	30
4	30.48	1.200	25

**Accessories**

**Note:** Refer to the Accessories chapter for additional accessories.

<b>Coding</b>	<b>Order No.</b>
BV/SV 7.62HP K0	1937590000
<b>Screwdriver</b>	
SDS 0.8X4.5X125	9009020000
<b>Crimping tool</b>	
PZ 6/5	9011460000
<b>Coupling set</b>	
SVF/BVF 7.62HP COUPLE SET	1440850000

**Representative deratings curve**

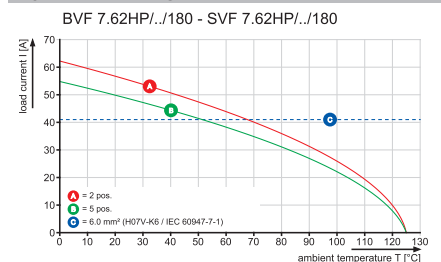

SVF 7.62HP../180SFMF3



Dimensioned drawing

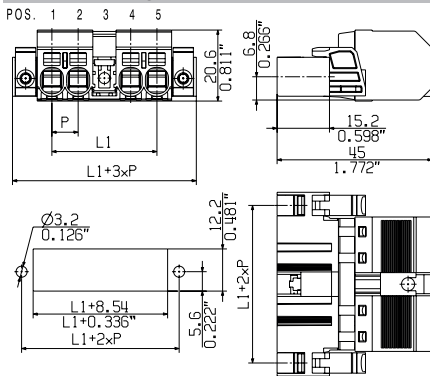

Ordering data

Solder pin length					
Colour					Black
Pitch 7.62 mm					
Pol.	L1	(inch)	Qty.	Order No.	
3	22.86	0.900	30	1427240000	
4	30.48	1.200	25	1427260000	

SVF 7.62HP../180SFMF4



Dimensioned drawing

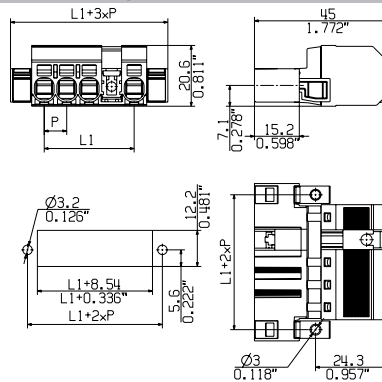

Ordering data

Solder pin length					
Colour					Black
Pitch 7.62 mm					
Pol.	L1	(inch)	Qty.	Order No.	
4	30.48	1.200	25	1427270000	

SVF/BCF 7.62HP COUPLE SET

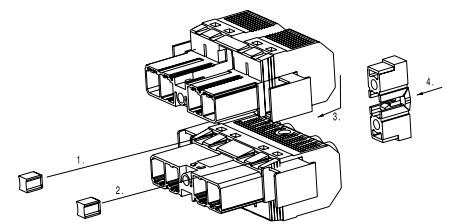

With the aid of the SVF/BVF 7.62HP COUPLE SET the two plug-in elements can be connected back-to-back to form a 2-row connector with a maximum of 2 x 4 poles.

**Plug-in connector, pitch 7.62 mm**  
**BV/SV 7.62 series - connection up to 6 mm<sup>2</sup>**

**SVF 7.62HP../180**

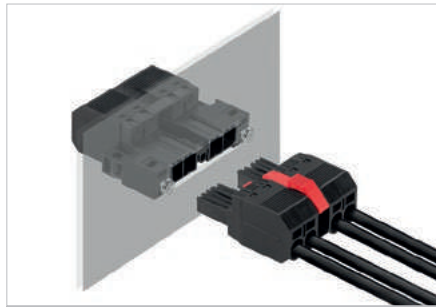

180° inverted male header featuring PUSH IN connection technology for field wiring in 6 mm<sup>2</sup> with a 7.62 pitch as a "three-flange variant" for enclosure feed-throughs. Suitable for enclosures with a max. wall thickness of 16 mm. Also a perfect finger-safe solution for reverse voltages. Meets the requirements of UL1059 600 V Class C and IEC 61800-5-1.

**Technical data**

<b>In compliance with IEC 60664-1 / IEC 61984</b>			
Clamping range, max.	mm <sup>2</sup>	0.5...10	
<b>Solid core H05(07) V-U</b>	<b>mm<sup>2</sup></b>	<b>0.5...6</b>	
Stranded H07 V-R		...10	
Flexible H05(07) V-K	mm <sup>2</sup>	0.5...10	
Flexible with ferrule	mm <sup>2</sup>	1.5...6	
Ferrule with plastic collar	mm <sup>2</sup>	1.5...6	
Stripping length	mm	12	
Screwdriver blade	mm	0.6 x 3.5	
According to norm			
Tightening torque range			
<b>Rated current, max.</b>	<b>A</b>	<b>57</b>	<b>57</b>
At ambient temperature		20°C	40°C
For conductor cross-section			
Overvoltage category		III	III II
Pollution severity		3	2 2
<b>Rated voltage</b>	<b>V</b>	<b>800</b>	<b>800 1000</b>
Rated impulse voltage	kV	8	8 6
<b>UL / CUL (Use Group)</b>		<b>B</b>	<b>C D</b>
<b>Rated voltage</b>	<b>V</b>	<b>600</b>	<b>600 600</b>
<b>Rated current</b>	<b>A</b>	<b>39</b>	<b>39 5</b>
<b>AWG conductor</b>	<b>AWG</b>	<b>24-10</b>	
<b>CSA (Use Group)</b>		<b>B</b>	<b>C D</b>
Rated voltage	V	600	600 600
Rated current	A	36	36 5
AWG conductor	AWG	24-10	
<b>General data</b>			
Type of insulation material		PA GF	
UL 94 flammability rating		V-0	
Contact base material		Copper alloy	
Material of contact surface		tinned	
Pin dimensions = d	mm		
Solder eyelet Ø = D	mm		
Solder eyelet Ø tolerance	mm		

**Product data**

IEC: 1000 V / 57 A / 0.5 - 10 mm<sup>2</sup>  
 UL: 600 V / 39 A / AWG 24 - 10



For additional articles and information, refer to [catalog.weidmuller.com](http://catalog.weidmuller.com)

**Note:**

- Additional colours on request
- Rated current related to rated cross-section & min. No. of poles.
- Wire end ferrule without plastic collar to DIN 46228/1
- Wire end ferrule with plastic collar to DIN 46228/4
- P on drawing = pitch
- Rated data refer only to the component itself. Clearance and creepage distances to other components are to be designed in accordance with the relevant application standards.
- MFX and MSFX: X= Position of the middle flange e.g. MF2, MSF3

**SVF 7.62HP../180SFBMF2**



**Dimensioned drawing**

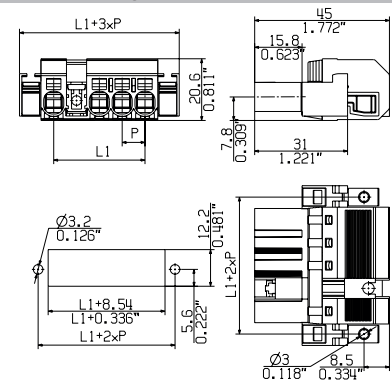

**Ordering data**

<b>Solder pin length</b>				
<b>Colour</b>	<b>Black</b>			
<b>Pitch</b>	<b>7.62 mm</b>			
<b>Pol.</b>	<b>L1</b>	<b>(inch)</b>	<b>Qty.</b>	<b>Order No.</b>
2	15.24	0.600	40	1429920000
3	22.86	0.900	30	1429930000
4	30.48	1.200	25	1429950000

**Accessories**

**Note:** Refer to the Accessories chapter for additional accessories.

<b>Coding</b>	<b>Order No.</b>
BV/SV 7.62HP K0	1937590000
<b>Screwdriver</b>	
SDS 0.8X4.5X125	9009020000
<b>Crimping tool</b>	
PZ 6/5	9011460000
<b>Coupling set</b>	
SVF/BVF 7.62HP COUPLE SET	1440850000

**Representative deratings curve**

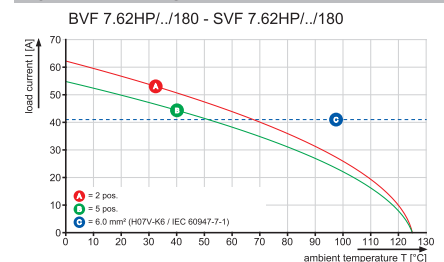



SVF 7.62HP../180SFBMF3



Dimensioned drawing

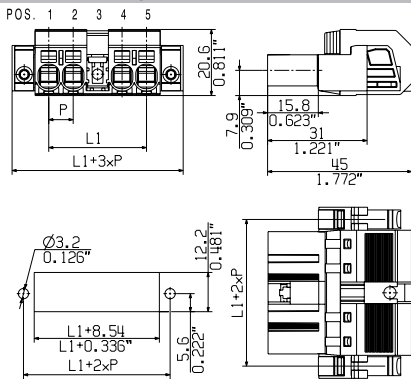

Ordering data

Solder pin length					
Colour					Black
Pitch 7.62 mm					
Pol.	L1	(inch)	Qty.	Order No.	
3	22.86	0.900	30	1429940000	
4	30.48	1.200	25	1429960000	

SVF 7.62HP../180SFBMF4



Dimensioned drawing

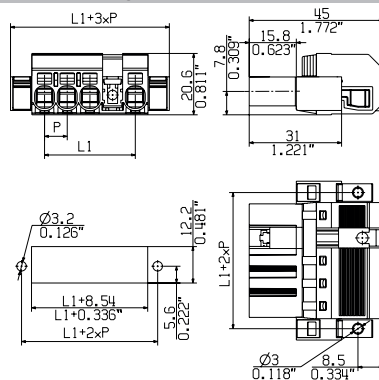

Ordering data

Solder pin length					
Colour					Black
Pitch 7.62 mm					
Pol.	L1	(inch)	Qty.	Order No.	
4	30.48	1.200	25	1429970000	

SVF/BCF 7.62HP COUPLE SET

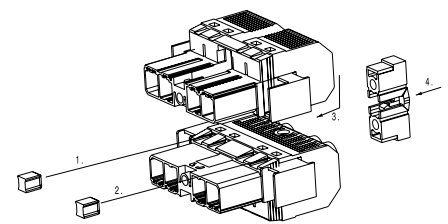

With the aid of the SVF/BVF 7.62HP COUPLE SET the two plug-in elements can be connected back-to-back to form a 2-row connector with a maximum of 2 x 4 poles.

**Plug-in connector, pitch 7.62 mm**  
**BV/SV 7.62 series - connection up to 6 mm<sup>2</sup>**

**SVFL 7.62HP../180**

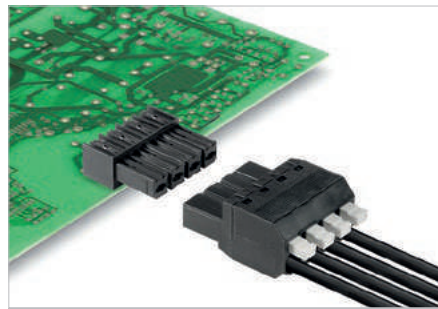

Male plug with 180° outlet direction and adjustable actuator (PUSHER) featuring PUSH IN spring connection technology for TNC(S) networks. Also perfect as a touch-safe solution for reverse voltages. Meets the requirements of UL1059 for 600 V Use Group C. The pin arrangement ensures finger-safety of >3 mm in accordance with IEC 61800-5-1.

Maximum connection and operating reliability due to: derating up to 125°C, a 100 % pin arrangement that prevents wrong connections or wrong wiring, and unique coding diversity.

Variants: middle flange and middle screw flange mountings.

**Product data**

IEC: 1000 V / 41 A / 0.5 - 6 mm<sup>2</sup>  
 UL: 600 V / 36 A / AWG 24 - 10



For additional articles and information, refer to [catalog.weidmueller.com](http://catalog.weidmueller.com)

**Note:**

- Additional colours on request
- Rated current related to rated cross-section & min. No. of poles.
- Wire end ferrule with plastic collar to DIN 46228/4
- Wire end ferrule without plastic collar to DIN 46228/1
- P on drawing = pitch
- Rated data refer only to the component itself. Clearance and creepage distances to other components are to be designed in accordance with the relevant application standards.
- Additional pole combinations on request
- MFX and MSFX: X= Position of the middle flange e.g. MF2, MSF3

**SVFL 7.62HP../180G**



**Dimensioned drawing**

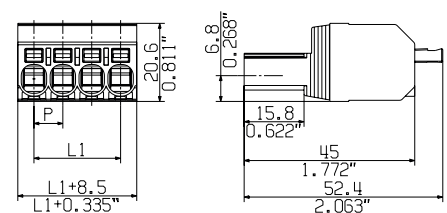

**Technical data**

In compliance with IEC 60664-1 / IEC 61984			
Clamping range, max.	mm <sup>2</sup>	0.5...6	
<b>Solid core H05(07) V-U</b>	mm <sup>2</sup>	<b>0.5...6</b>	
Stranded H07 V-R			
Flexible H05(07) V-K	mm <sup>2</sup>	0.5...6	
Flexible with ferrule	mm <sup>2</sup>	1.5...6	
Ferrule with plastic collar	mm <sup>2</sup>	1.5...6	
Stripping length	mm	12	
Screwdriver blade	mm	0.6 x 3.5	
According to norm			
Tightening torque range			
<b>Rated current, max.</b>	<b>A</b>	<b>41</b>	<b>41</b>
At ambient temperature		20°C	40°C
For conductor cross-section			
Overvoltage category		III	III II
Pollution severity		3	2 2
<b>Rated voltage</b>	<b>V</b>	<b>800</b>	<b>800 1000</b>
Rated impulse voltage	kV	8	8 6
<b>UL / CUL (Use Group)</b>		<b>B</b>	<b>C D</b>
<b>Rated voltage</b>	<b>V</b>	<b>600</b>	<b>600 600</b>
<b>Rated current</b>	<b>A</b>	<b>36</b>	<b>36 5</b>
<b>AWG conductor</b>	<b>AWG</b>	<b>24-10</b>	
<b>CSA (Use Group)</b>		<b>B</b>	<b>C D</b>
Rated voltage	V	600	600 600
Rated current	A	35	35 5
AWG conductor	AWG	24-10	
<b>General data</b>			
Type of insulation material		PA GF	
UL 94 flammability rating		V-0	
Contact base material		Copper alloy	
Material of contact surface		tinned	
Pin dimensions = d	mm		
Solder eyelet Ø = D	mm		
Solder eyelet Ø tolerance	mm		

**Accessories**

**Note:** Refer to the Accessories chapter for additional accessories.

Coding		Order No.
	BV/SV 7.62HP K0	1937590000
<b>Screwdriver</b>		
	SDS 0.8X4.5X125	9009020000
<b>Crimping tool</b>		
	PZ 6/5	9011460000

**Ordering data**

Solder pin length				
Colour	Black			
Pitch	7.62 mm			
Pol.	L1	(inch)	Qty.	Order No.
4	22.86	0.900	36	1547550000

Additional pole combinations on request

**Representative deratings curve**

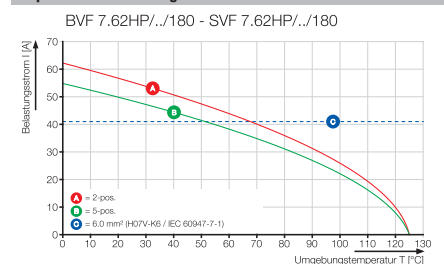

Additional pole combinations on request

SVFL 7.62HP/./180F



Dimensioned drawing

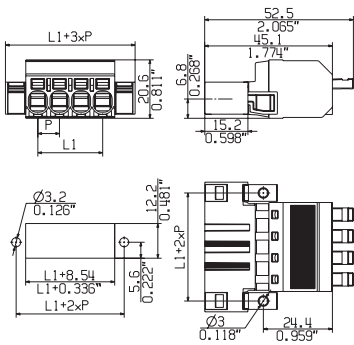

Ordering data

Solder pin length				
Colour				Black
Pitch		7.62 mm		
Pol.	L1	(inch)	Qty.	Order No.
4	22.86	0.900	24	1547570000

Additional pole combinations on request

**Plug-in connector, pitch 7.62 mm**  
**BV/SV 7.62 series - connection up to 6 mm<sup>2</sup>**

**SVFL 7.62HP../180MF**

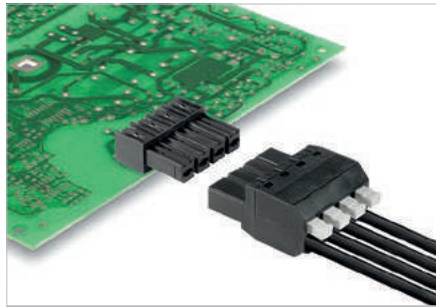

Male plug with 180° outlet direction and adjustable actuator (PUSHER) featuring PUSH IN spring connection technology for TNC(S) networks. Also perfect as a touch-safe solution for reverse voltages. Meets the requirements of UL1059 for 600 V Use Group C. The pin arrangement ensures finger-safety of >3 mm in accordance with IEC 61800-5-1.

Maximum connection and operating reliability due to: derating up to 125°C, a 100 % pin arrangement that prevents wrong connections or wrong wiring, and unique coding diversity.

Variants: middle flange and middle screw flange mountings.

**Product data**

IEC: 1000 V / 41 A / 0.5 - 6 mm<sup>2</sup>  
 UL: 600 V / 36 A / AWG 24 - 10



For additional articles and information, refer to [catalog.weidmuller.com](http://catalog.weidmuller.com)

**Note:**

- Additional colours on request
- Rated current related to rated cross-section & min. No. of poles.
- Wire end ferrule with plastic collar to DIN 46228/4
- Wire end ferrule without plastic collar to DIN 46228/1
- P on drawing = pitch
- Rated data refer only to the component itself. Clearance and creepage distances to other components are to be designed in accordance with the relevant application standards.
- Additional pole combinations on request
- MFX and MSFX: X= Position of the middle flange e.g. MF2, MSF3

**SVFL 7.62HP../180MF2**



**Dimensioned drawing**

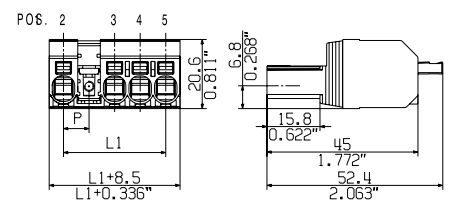

**Technical data**

**In compliance with IEC 60664-1 / IEC 61984**

Clamping range, max.	mm <sup>2</sup>	0.5...6
<b>Solid core H05(07) V-U</b>	<b>mm<sup>2</sup></b>	<b>0.5...6</b>
Stranded H07 V-R		
Flexible H05(07) V-K	mm <sup>2</sup>	0.5...6
Flexible with ferrule	mm <sup>2</sup>	1.5...6
Ferrule with plastic collar	mm <sup>2</sup>	1.5...6
Stripping length	mm	12
Screwdriver blade	mm	0.6 x 3.5

According to norm

Tightening torque range

**Rated current, max.**      **A**    **41**      **41**

At ambient temperature      20°C      40°C

For conductor cross-section

Overtoltage category      III    III    II

Pollution severity      3    2    2

**Rated voltage**      **V**    **800**    **800**    **1000**

Rated impulse voltage      kV    8    8    6

**UL / CUL (Use Group)**      **B**    **C**    **D**

**Rated voltage**      **V**    **600**    **600**    **600**

**Rated current**      **A**    **36**    **36**    **5**

**AWG conductor**      **AWG**    **24-10**

**CSA (Use Group)**      **B**    **C**    **D**

Rated voltage      V    600    600    600

Rated current      A    35    35    5

AWG conductor      AWG    24-10

**General data**

Type of insulation material      PA GF

UL 94 flammability rating      V-0

Contact base material      Copper alloy

Material of contact surface      tinned

Pin dimensions = d      mm

Solder eyelet Ø = D      mm

Solder eyelet Ø tolerance      mm

**Accessories**

**Note:** Refer to the Accessories chapter for additional accessories.

**Ordering data**

<b>Solder pin length</b>				
<b>Colour</b>	<b>Black</b>			
<b>Pitch</b>	<b>7.62 mm</b>			
<b>Pol.</b>	<b>L1</b>	<b>(inch)</b>	<b>Qty.</b>	<b>Order No.</b>
2	15.24	0.600	65	2630260000
3	22.86	0.900	50	2630420000
4	30.48	1.200	40	2630430000
5	38.10	1.500	30	2630440000

**Representative deratings curve**

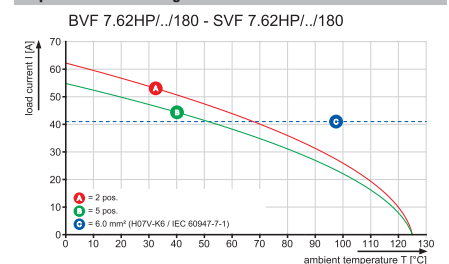

SVFL 7.62HP../180MF3



Dimensioned drawing

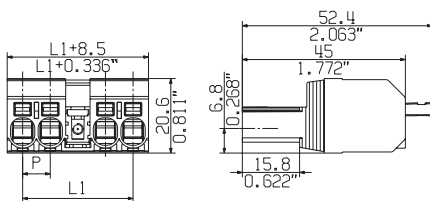

SVFL 7.62HP../180MF4



Dimensioned drawing

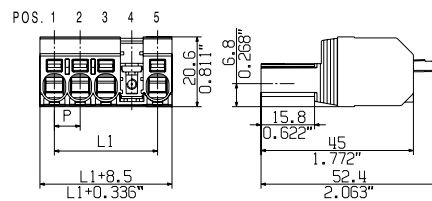

Ordering data

Solder pin length					
Colour					Black
Pitch 7.62 mm					
Pol.	L1	(inch)	Qty.	Order No.	
3	22.86	0.900	50	2630450000	
4	30.48	1.200	32	1547580000	
5	38.10	1.500	30	2630460000	

Ordering data

Solder pin length					
Colour					Black
Pitch 7.62 mm					
Pol.	L1	(inch)	Qty.	Order No.	
4	30.48	1.200	40	2630470000	
5	38.10	1.500	30	2630480000	

**Plug-in connector, pitch 7.62 mm**  
**BV/SV 7.62 series - connection up to 6 mm<sup>2</sup>**

**BVZ 7.62HP/./180**

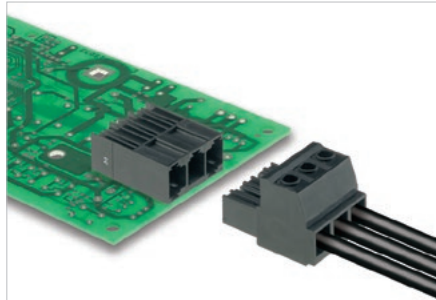

Female plug in 180° outlet direction with clamping yoke screw connection for TNC (S) systems. Meets the requirements of UL1059 for 600 V Use Group C. The mating profile ensures touch-safety of > 3 mm in accordance with IEC 61800-5-1.

Maximum operational reliability: with a derating up to 125°C, a mating profile that can only be plugged in correct, and unique coding capability.

- Available with a flange (F), screw flange (SF) and clip on screw flange (SFC)

**Product data**

IEC: 1000 V / 57 A / 0.2 - 10 mm<sup>2</sup>  
 UL: 600 V / 40.5 A / AWG 24 - 8



For additional articles and information, refer to [catalog.weidmueller.com](http://catalog.weidmueller.com)

**Note:**

- Additional colours on request
- Rated current related to rated cross-section & min. No. of poles.
- Wire end ferrule with plastic collar to DIN 46228/4
- Wire end ferrule without plastic collar to DIN 46228/1
- P on drawing = pitch
- Rated data refer only to the component itself. Clearance and creepage distances to other components are to be designed in accordance with the relevant application standards.

**BVZ 7.62HP/./180**



**Dimensioned drawing**

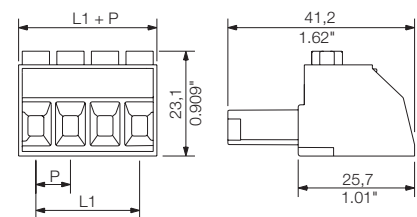

**Technical data**

**In compliance with IEC 60664-1 / IEC 61984**

Clamping range, max.	mm <sup>2</sup>	0.2...10
<b>Solid core H05(07) V-U</b>	<b>mm<sup>2</sup></b>	<b>0.2...6</b>
Stranded H07 V-R		
Flexible H05(07) V-K	mm <sup>2</sup>	0.5...10
Flexible with ferrule	mm <sup>2</sup>	0.25...6
Ferrule with plastic collar	mm <sup>2</sup>	0.25...6
Stripping length	mm	12
Screwdriver blade	mm	0.6 x 3.5

According to norm

Tightening torque range	Nm	0.5...0.6
<b>Rated current, max.</b>		<b>57 41</b>
At ambient temperature	20°C 40°C	
For conductor cross-section	mm <sup>2</sup>	6
Overvoltage category		III III II
Pollution severity		3 2 2

<b>Rated voltage</b>	<b>V</b>	<b>800 1000 1000</b>
Rated impulse voltage	kV	8 8 6

<b>UL / CUL (Use Group)</b>	<b>B C D</b>
-----------------------------	--------------

<b>Rated voltage</b>	<b>V</b>	<b>600 600 600</b>
<b>Rated current</b>	<b>A</b>	<b>40.5 40.5 5</b>
<b>AWG conductor</b>	<b>AWG</b>	<b>24-8</b>

<b>CSA (Use Group)</b>	<b>B C D</b>
------------------------	--------------

Rated voltage	V	600 600 600
Rated current	A	40.5 40.5 5
AWG conductor	AWG	24-8

**General data**

Type of insulation material	PA GF
UL 94 flammability rating	V-0
Contact base material	Copper alloy
Material of contact surface	tinned
Pin dimensions = d	mm
Solder eyelet Ø = D	mm
Solder eyelet Ø tolerance	mm

**Accessories**

**Note:** Refer to the Accessories chapter for additional accessories.

Coding	Order No.
BV/SV 7.62HP K0	1937590000
<b>Strain relief</b>	
BV/SV 7.62HP/02 ZE GR	1937550000
BV/SV 7.62HP/04 ZE GR	1937560000
<b>Screwdriver</b>	
SDS 0.8X4.5X125	9009020000
<b>Crosshead screwdriver</b>	
SDK PH1	9008480000

**Ordering data**

Solder pin length				
Colour	Black			
Pitch	7.62 mm			
Pol.	L1	(inch)	Qty.	Order No.
2	7.62	0.300	100	1929930000
3	15.24	0.600	100	1929940000
4	22.86	0.900	100	1929950000
5	30.48	1.200	50	1929960000
6	38.10	1.500	50	1929970000
7	45.72	1.800	50	1929980000
8	53.34	2.100	50	1929990000
9	60.96	2.400	50	1930000000
10	68.58	2.700	50	1930020000
11	76.20	3.000	50	1930030000
12	83.82	3.300	50	1930040000

**Representative deratings curve**

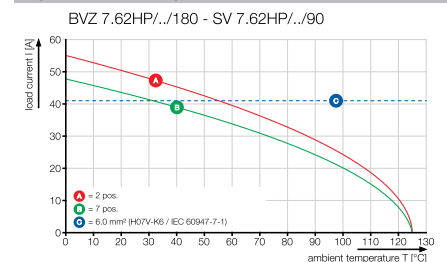

**BVZ 7.62HP../180F**



Dimensioned drawing

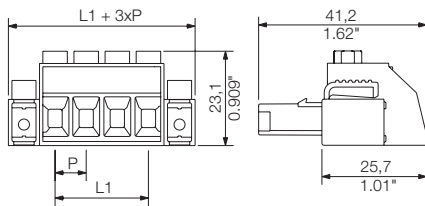

**Ordering data**

Solder pin length					
Colour					Black
Pitch	7.62 mm		Qty.	Order No.	
Pol. 2	L1 7.62	(inch) 0.300	100	1930050000	
3	15.24	0.600	100	1930060000	
4	22.86	0.900	100	1930070000	
5	30.48	1.200	50	1930080000	
6	38.10	1.500	50	1930090000	
7	45.72	1.800	50	1930100000	
8	53.34	2.100	50	1930110000	
9	60.96	2.400	50	1930120000	
10	68.58	2.700	50	1930130000	
11	76.20	3.000	50	1930140000	
12	83.82	3.300	50	1930150000	

**BVZ 7.62HP../180SF**



Dimensioned drawing

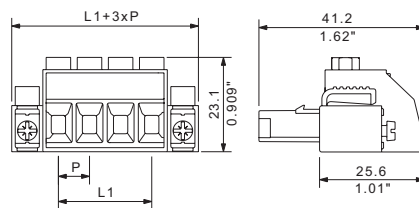

**Ordering data**

Solder pin length					
Colour					Black
Pitch	7.62 mm		Qty.	Order No.	
Pol. 2	L1 7.62	(inch) 0.300	100	1930160000	
3	15.24	0.600	100	1930170000	
4	22.86	0.900	100	1930180000	
5	30.48	1.200	50	1930190000	
6	38.10	1.500	50	1930200000	
7	45.72	1.800	50	1930210000	
8	53.34	2.100	50	1930220000	
9	60.96	2.400	50	1930230000	
10	68.58	2.700	50	1930240000	
11	76.20	3.000	50	1930250000	
12	83.82	3.300	50	1930260000	

**BVZ 7.62HP../180SFC**



Dimensioned drawing

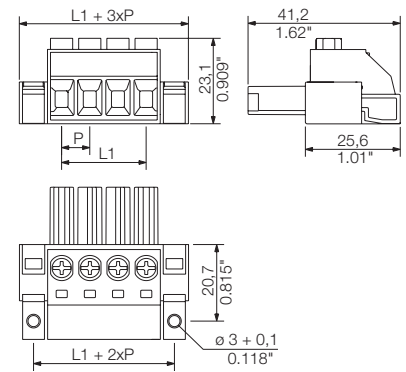

**Ordering data**

Solder pin length					
Colour					Black
Pitch	7.62 mm		Qty.	Order No.	
Pol. 2	L1 7.62	(inch) 0.300	100	1929740000	
3	15.24	0.600	100	1929750000	
4	22.86	0.900	100	1929760000	
5	30.48	1.200	50	1929770000	
6	38.10	1.500	50	1929780000	
7	45.72	1.800	50	1929790000	

Also available with a clip-on flange (-180FC).

**Additional deratings curves**

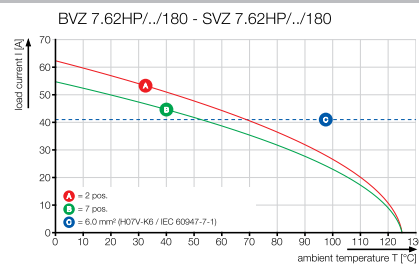
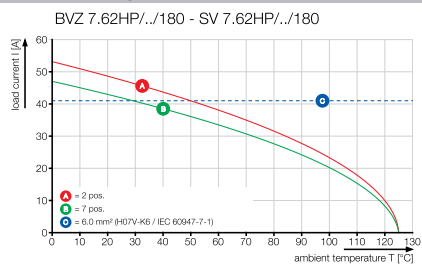

**Plug-in connector, pitch 7.62 mm**  
**BV/SV 7.62 series - connection up to 6 mm<sup>2</sup>**

**BVZ 7.62HP../180SH**

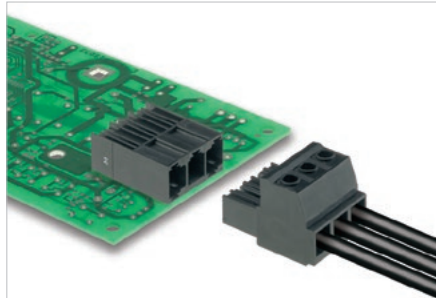

Female plug in 180° outlet direction with clamping yoke screw connection and additional shield connection for TNC (S) systems. Meets the requirements of UL1059 for 600 V Use Group C. The mating profile ensures touch-safety of > 3 mm in accordance with IEC 61800-5-1.

Maximum operational reliability with a derating up to 125°C, a mating profile that can only be plugged in correct, and unique coding capability.

- Available with shield in three different orientations.

**Technical data**

**In compliance with IEC 60664-1 / IEC 61984**

Clamping range, max.	mm <sup>2</sup>	0.2...10
<b>Solid core H05(07) V-U</b>	<b>mm<sup>2</sup></b>	<b>0.2...6</b>
Stranded H07 V-R		
Flexible H05(07) V-K	mm <sup>2</sup>	0.5...10
Flexible with ferrule	mm <sup>2</sup>	0.25...6
Ferrule with plastic collar	mm <sup>2</sup>	0.25...6
Stripping length	mm	12
Screwdriver blade	mm	0.6 x 3.5

According to norm

Tightening torque range	Nm	0.5...0.6
<b>Rated current, max.</b>		<b>57 41</b>
At ambient temperature	20°C 40°C	
For conductor cross-section	mm <sup>2</sup>	6
Overvoltage category		III III II
Pollution severity		3 2 2

<b>Rated voltage</b>	<b>V</b>	<b>800 1000 1000</b>
Rated impulse voltage	kV	8 8 6
<b>UL / CUL (Use Group)</b>		<b>B C D</b>

<b>Rated voltage</b>	<b>V</b>	<b>600 600 600</b>
<b>Rated current</b>	<b>A</b>	<b>40.5 40.5 5</b>
<b>AWG conductor</b>	<b>AWG</b>	<b>24-8</b>
<b>CSA (Use Group)</b>		<b>B C D</b>
Rated voltage	V	600 600 600
Rated current	A	40.5 40.5 5
AWG conductor	AWG	24-8

**General data**

Type of insulation material		PA GF
UL 94 flammability rating		V-0
Contact base material		Copper alloy
Material of contact surface		tinned
Pin dimensions = d	mm	
Solder eyelet Ø = D	mm	
Solder eyelet Ø tolerance	mm	

**Product data**

IEC: 1000 V / 57 A / 0.2 - 10 mm<sup>2</sup>  
 UL: 600 V / 40.5 A / AWG 24 - 8



For additional articles and information, refer to [catalog.weidmueller.com](http://catalog.weidmueller.com)

**Note:**

- Additional colours on request
- Rated current related to rated cross-section & min. No. of poles.
- Wire end ferrule with plastic collar to DIN 46228/4
- Wire end ferrule without plastic collar to DIN 46228/1
- P on drawing = pitch
- Rated data refer only to the component itself. Clearance and creepage distances to other components are to be designed in accordance with the relevant application standards.

**BVZ 7.62HP../180SH160**



**Dimensioned drawing**

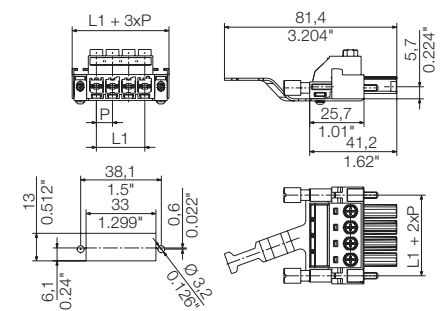

**Ordering data**

<b>Solder pin length</b>				
<b>Colour</b>	<b>Black</b>			
<b>Pitch</b>	<b>7.62 mm</b>			
<b>Pol.</b>	<b>L1</b>	<b>(inch)</b>	<b>Qty.</b>	<b>Order No.</b>
3	15.24	0.600	50	1929850000
4	22.86	0.900	25	1929860000
5	30.48	1.200	25	1929870000
6	38.10	1.500	25	1929880000

**Accessories**

**Note:** Refer to the Accessories chapter for additional accessories.

<b>Coding</b>	<b>Order No.</b>
BV/SV 7.62HP K0	1937590000
<b>Strain relief</b>	
BV/SV 7.62HP/02 ZE GR	1937550000
BV/SV 7.62HP/04 ZE GR	1937560000
<b>Screwdriver</b>	
SDS 0.8X4.5X125	9009020000
<b>Crosshead screwdriver</b>	
SDK PH1	9008480000

**Representative deratings curve**

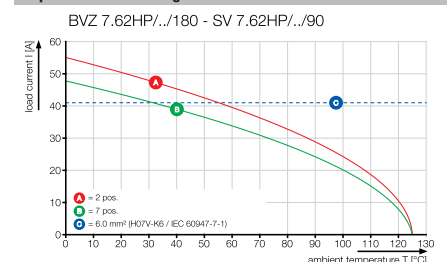



**BVZ 7.62HP../180SH180**



Dimensioned drawing

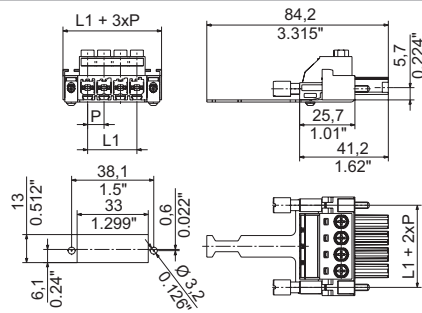

FRONT PLATE CUT-OUT

**Ordering data**

Solder pin length					
Colour					Black
Pitch 7.62 mm					
Pol.	L1	(inch)	Qty.	Order No.	
3	15.24	0.600	50	1933340000	
4	22.86	0.900	25	1933350000	
5	30.48	1.200	25	1933360000	
6	38.10	1.500	25	1933370000	

**BVZ 7.62HP../180SH200**



Dimensioned drawing

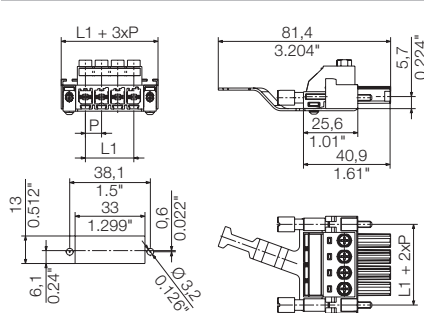

FRONT PLATE CUT-OUT

**Ordering data**

Solder pin length					
Colour					Black
Pitch 7.62 mm					
Pol.	L1	(inch)	Qty.	Order No.	
3	15.24	0.600	50	1933430000	
4	22.86	0.900	25	1933440000	
5	30.48	1.200	25	1933450000	
6	38.10	1.500	25	1933460000	



**Additional deratings curves**

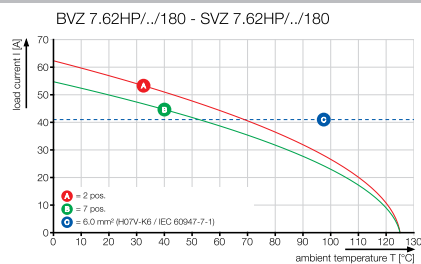
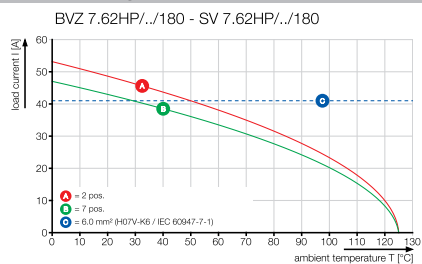

Plug-in connector, pitch 7.62 mm  
BV/SV 7.62 series - connection up to 6 mm<sup>2</sup>

BVZ 7.62HP../180SH C

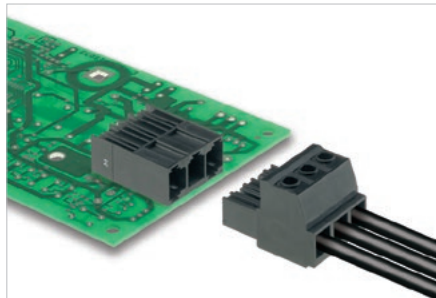

Female plug in 180° outlet direction with clamping yoke screw connection and additional shield connection for TNC (S) systems. Meets the requirements of UL1059 for 600 V Use Group C. The mating profile ensures touch-safety of > 3 mm in accordance with IEC 61800-5-1.

Maximum operational reliability with a derating up to 125°C, a mating profile that can only be plugged in correct, and unique coding capability.

- Available with shield in three different orientations.

Technical data

In compliance with IEC 60664-1 / IEC 61984

Clamping range, max.	mm <sup>2</sup>	0.2...10
<b>Solid core H05(07) V-U</b>	<b>mm<sup>2</sup></b>	<b>0.2...6</b>
Stranded H07 V-R		
Flexible H05(07) V-K	mm <sup>2</sup>	0.5...10
Flexible with ferrule	mm <sup>2</sup>	0.25...6
Ferrule with plastic collar	mm <sup>2</sup>	0.25...6
Stripping length	mm	12
Screwdriver blade	mm	0.6 x 3.5

According to norm

Tightening torque range	Nm	0.5...0.6
<b>Rated current, max.</b>		<b>57      41</b>
At ambient temperature	20°C      40°C	
For conductor cross-section	mm <sup>2</sup>	6
Overvoltage category	III      III      II	
Pollution severity	3      2      2	
<b>Rated voltage</b>	<b>V</b>	<b>800   1000   1000</b>
Rated impulse voltage	kV	8      8      6
<b>UL / CUL (Use Group)</b>		<b>B      C      D</b>

<b>Rated voltage</b>	<b>V</b>	<b>600   600   600</b>
<b>Rated current</b>	<b>A</b>	<b>40.5   40.5   5</b>
<b>AWG conductor</b>	<b>AWG</b>	<b>24-8</b>
<b>CSA (Use Group)</b>		<b>B      C      D</b>
Rated voltage	V	600   600   600
Rated current	A	40.5   40.5   5
AWG conductor	AWG	24-8

General data

Type of insulation material	PA GF
UL 94 flammability rating	V-0
Contact base material	Copper alloy
Material of contact surface	tinned
Pin dimensions = d	mm
Solder eyelet Ø = D	mm
Solder eyelet Ø tolerance	mm

Product data

IEC: 1000 V / 57 A / 0.2 - 10 mm<sup>2</sup>  
UL: 600 V / 40.5 A / AWG 24 - 8



For additional articles and information, refer to [catalog.weidmueller.com](http://catalog.weidmueller.com)

Note:

- Additional colours on request
- Rated current related to rated cross-section & min. No. of poles.
- Wire end ferrule with plastic collar to DIN 46228/4
- Wire end ferrule without plastic collar to DIN 46228/1
- P on drawing = pitch
- Rated data refer only to the component itself. Clearance and creepage distances to other components are to be designed in accordance with the relevant application standards.

BVZ 7.62HP../180SH160C



Dimensioned drawing

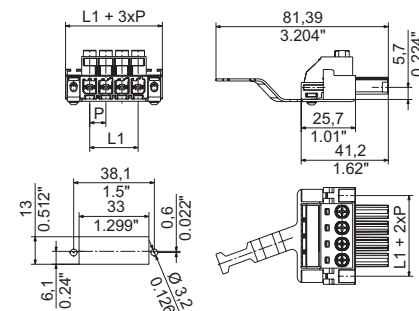

FRONT PLATE CUT-OUT

Ordering data

<b>Solder pin length</b>				
<b>Colour</b>	<b>Black</b>			
<b>Pitch</b>	<b>7.62 mm</b>			
<b>Pol.</b>	<b>L1</b>	<b>(inch)</b>	<b>Qty.</b>	<b>Order No.</b>
3	15.24	0.600	50	1929890000
4	22.86	0.900	25	1929900000
5	30.48	1.200	25	1929910000
6	38.10	1.500	25	1929920000

Accessories

Note: Refer to the Accessories chapter for additional accessories.

<b>Coding</b>	<b>Order No.</b>
BV/SV 7.62HP K0	1937590000
<b>Strain relief</b>	
BV/SV 7.62HP/02 ZE GR	1937550000
BV/SV 7.62HP/04 ZE GR	1937560000
<b>Screwdriver</b>	
SDS 0.8x4.5x125	9009020000
<b>Crosshead screwdriver</b>	
SDK PH1	9008480000

K

7.62

180°

6 mm<sup>2</sup>

Representative deratings curve

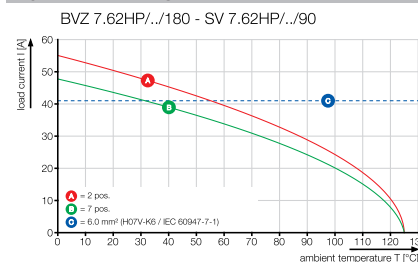

**BVZ 7.62HP../180SH180C**



Dimensioned drawing

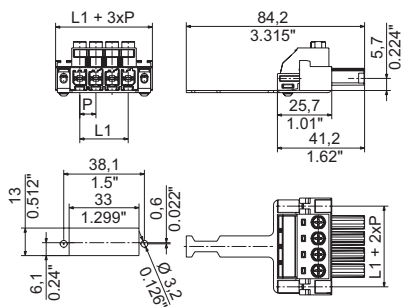

FRONT PLATE CUT-OUT

**Ordering data**

Solder pin length					
Colour					Black
Pitch 7.62 mm					
Pol.	L1	(inch)	Qty.	Order No.	
3	15.24	0.600	50	1933380000	
4	22.86	0.900	25	1933390000	
5	30.48	1.200	25	1933400000	
6	38.10	1.500	25	1933410000	

**BVZ 7.62HP../180SH200C**



Dimensioned drawing

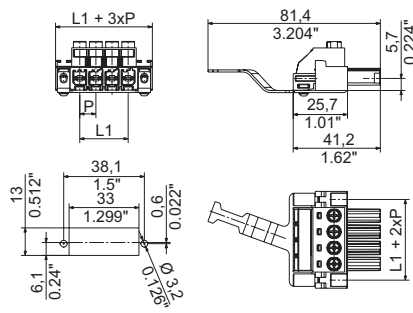

FRONT PLATE CUT-OUT

**Ordering data**

Solder pin length					
Colour					Black
Pitch 7.62 mm					
Pol.	L1	(inch)	Qty.	Order No.	
3	15.24	0.600	50	1933470000	
4	22.86	0.900	25	1933480000	
5	30.48	1.200	25	1933490000	
6	38.10	1.500	25	1933500000	



**Additional deratings curves**

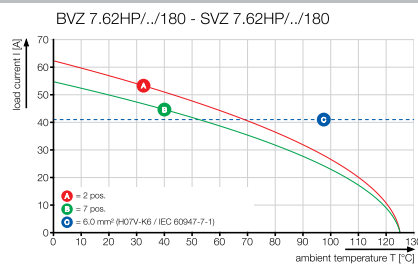
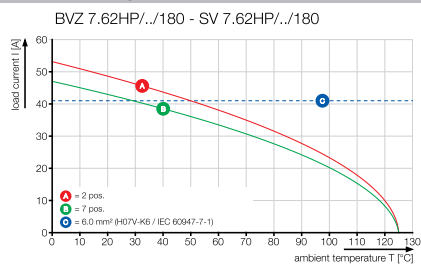

**Plug-in connector, pitch 7.62 mm**  
**BV/SV 7.62 series - connection up to 6 mm<sup>2</sup>**

**BVF 7.62HP../180**

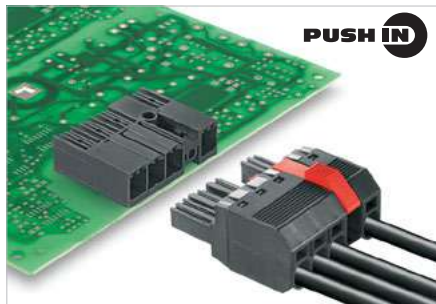

Female plug in 180° outlet direction with "PUSH IN" spring connection for TNC (S) systems. Meets the requirements of UL1059 for 600 V Use Group C. The mating profile ensures touch-safety of > 3 mm in accordance with IEC 61800-5-1.

Maximum operational reliability with a derating up to 125°C, a mating profile that can only be plugged in correct, and unique coding capability.

- Available with a flange (F), screw flange (SF) and middle flange (MF).

**Technical data**

In compliance with IEC 60664-1 / IEC 61984			
Clamping range, max.	mm <sup>2</sup>	0.5...10	
<b>Solid core H05(07) V-U</b>	<b>mm<sup>2</sup></b>	<b>0.5...10</b>	
Stranded H07 V-R		...10	
Flexible H05(07) V-K	mm <sup>2</sup>	0.5...10	
Flexible with ferrule	mm <sup>2</sup>	1.5...10	
Ferrule with plastic collar	mm <sup>2</sup>	1.5...6	
Stripping length	mm	12	
Screwdriver blade	mm	0.6 x 3.5	
According to norm			
Tightening torque range			
<b>Rated current, max.</b>	<b>A</b>	<b>57</b>	<b>57</b>
At ambient temperature		20°C	40°C
For conductor cross-section	mm <sup>2</sup>	6	
Overvoltage category		III	III II
Pollution severity		3	2 2
<b>Rated voltage</b>	<b>V</b>	<b>800</b>	<b>1000 1000</b>
Rated impulse voltage	kV	8	8 6
<b>UL / CUL (Use Group)</b>		<b>B</b>	<b>C D</b>
<b>Rated voltage</b>	<b>V</b>	<b>600</b>	<b>600 600</b>
<b>Rated current</b>	<b>A</b>	<b>39</b>	<b>39 5</b>
<b>AWG conductor</b>	<b>AWG</b>	<b>24-8</b>	
<b>CSA (Use Group)</b>		<b>B</b>	<b>C D</b>
Rated voltage	V	600	600 600
Rated current	A	33	33 5
AWG conductor	AWG	24-8	
<b>General data</b>			
Type of insulation material		PA GF	
UL 94 flammability rating		V-0	
Contact base material		Copper alloy	
Material of contact surface		tinned	
Pin dimensions = d	mm		
Solder eyelet Ø = D			
Solder eyelet Ø tolerance	mm		

**Product data**

IEC: 1000 V / 57 A / 0.5 - 10 mm<sup>2</sup>  
 UL: 600 V / 39 A / AWG 24 - 8



For additional articles and information, refer to [catalog.weidmueller.com](http://catalog.weidmueller.com)

**Note:**

- Additional colours on request
- Wire end ferrule with plastic collar to DIN 46228/4
- Wire end ferrule without plastic collar to DIN 46228/1
- P on drawing = pitch
- Rated data refer only to the component itself. Clearance and creepage distances to other components are to be designed in accordance with the relevant application standards.
- Versions with pusher, see BVFL

**BVF 7.62HP../180**



**Dimensioned drawing**

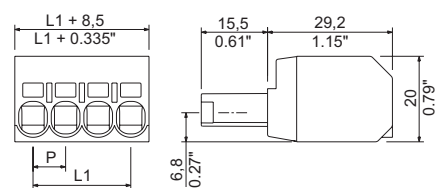

**Accessories**

**Note:** Refer to the Accessories chapter for additional accessories.

Coding		Order No.
	BV/SV 7.62HP K0	1937590000
<b>Screwdriver</b>		
	SDS 0.8X4.5X125	9009020000
<b>Crimping tool</b>		
	PZ 6/5	9011460000

**Ordering data**

Solder pin length				
Colour	Black			
Pitch	7.62 mm			
Pol.	L1	(inch)	Qty.	Order No.
2	7.62	0.300	95	1060390000
3	15.24	0.600	65	1060400000
4	22.86	0.900	45	1060410000
5	30.48	1.200	40	1060420000

**Representative deratings curve**

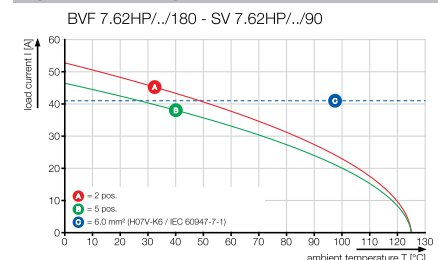

BVF 7.62HP../180F



Dimensioned drawing

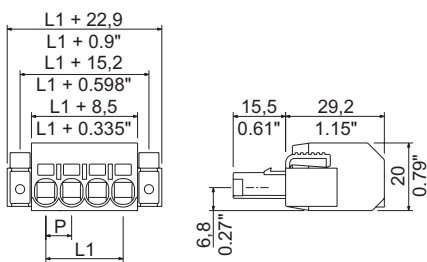

BVF 7.62HP../180SF



Dimensioned drawing

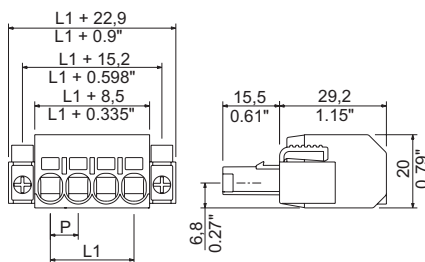

Ordering data

Solder pin length					
Colour					Black
Pitch 7.62 mm					
Pol.	L1	(inch)	Qty.	Order No.	
2	7.62	0.300	50	1060440000	
3	15.24	0.600	40	1060450000	
4	22.86	0.900	30	1060470000	
5	30.48	1.200	25	1060480000	
6	38.10	1.500	25	1060490000	

Ordering data

Solder pin length					
Colour					Black
Pitch 7.62 mm					
Pol.	L1	(inch)	Qty.	Order No.	
2	7.62	0.300	50	1060500000	
3	15.24	0.600	40	1060510000	
4	22.86	0.900	30	1060520000	
5	30.48	1.200	25	1060530000	
6	38.10	1.500	25	1060540000	



Additional deratings curves

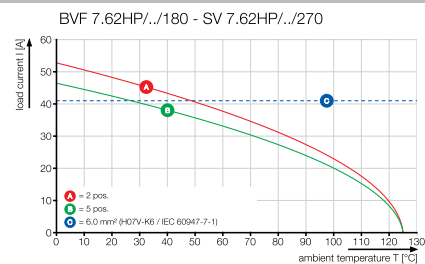
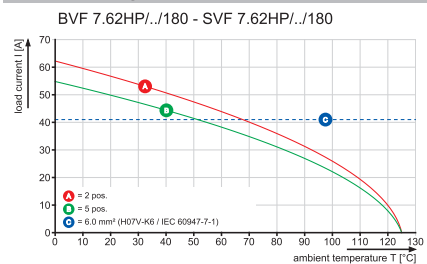

**Plug-in connector, pitch 7.62 mm**  
**BV/SV 7.62 series - connection up to 6 mm<sup>2</sup>**

**BVF 7.62HP../180MF**

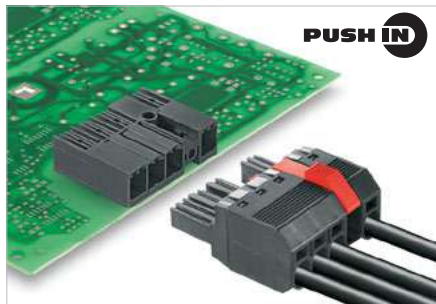

Female plug in 180° outlet direction with "PUSH IN" spring connection for TNC (S) systems. Meets the requirements of UL1059 for 600 V Use Group C. The mating profile ensures touch-safety of > 3 mm in accordance with IEC 61800-5-1.

Maximum operational reliability with a derating up to 125°C, a mating profile that can only be plugged in correct, and unique coding capability.

- Middle flange available in positions 2, 3 and 4.

**Technical data**

In compliance with IEC 60664-1 / IEC 61984			
Clamping range, max.	mm <sup>2</sup>	0.5...10	
<b>Solid core H05(07) V-U</b>	<b>mm<sup>2</sup></b>	<b>0.5...10</b>	
Stranded H07 V-R		...10	
Flexible H05(07) V-K	mm <sup>2</sup>	0.5...10	
Flexible with ferrule	mm <sup>2</sup>	1.5...10	
Ferrule with plastic collar	mm <sup>2</sup>	1.5...6	
Stripping length	mm	12	
Screwdriver blade	mm	0.6 x 3.5	
According to norm			
Tightening torque range			
<b>Rated current, max.</b>	<b>A</b>	<b>57</b>	<b>57</b>
At ambient temperature		20°C	40°C
For conductor cross-section	mm <sup>2</sup>	6	
Overvoltage category		III	III II
Pollution severity		3	2 2
<b>Rated voltage</b>	<b>V</b>	<b>800</b>	<b>1000 1000</b>
Rated impulse voltage	kV	8	8 6
<b>UL / CUL (Use Group)</b>		<b>B</b>	<b>C D</b>
<b>Rated voltage</b>	<b>V</b>	<b>600</b>	<b>600 600</b>
<b>Rated current</b>	<b>A</b>	<b>39</b>	<b>39 5</b>
<b>AWG conductor</b>	<b>AWG</b>		<b>24-8</b>
<b>CSA (Use Group)</b>		<b>B</b>	<b>C D</b>
Rated voltage	V	600	600 600
Rated current	A	33	33 5
AWG conductor	AWG		24-8
<b>General data</b>			
Type of insulation material		PA GF	
UL 94 flammability rating		V-0	
Contact base material		Copper alloy	
Material of contact surface		tinned	
Pin dimensions = d	mm		
Solder eyelet Ø = D	mm		
Solder eyelet Ø tolerance	mm		

**Product data**

IEC: 1000 V / 57 A / 0.5 - 10 mm<sup>2</sup>  
 UL: 600 V / 39 A / AWG 24 - 8



For additional articles and information, refer to [catalog.weidmuller.com](http://catalog.weidmuller.com)

**Note:**

- Additional colours on request
- Wire end ferrule with plastic collar to DIN 46228/4
- Wire end ferrule without plastic collar to DIN 46228/1
- P on drawing = pitch
- Rated data refer only to the component itself. Clearance and creepage distances to other components are to be designed in accordance with the relevant application standards.
- MFX and MSFX: X= Position of the middle flange e.g. MF2, MSF3
- Versions with pusher, see BVFL

**BVF 7.62HP../180MF2**



**Dimensioned drawing**

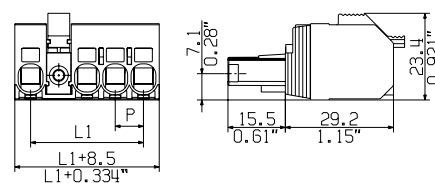

**K**

**7.62**

**180°**

**6 mm<sup>2</sup>**

**Accessories**

**Note:** Refer to the Accessories chapter for additional accessories.

Coding	Order No.
BV/SV 7.62HP K0	1937590000
<b>Strain relief</b>	
BV/SV 7.62HP/02 ZE GR	1937550000
BV/SV 7.62HP/04 ZE GR	1937560000
<b>Screwdriver</b>	
SDS 0.8X4.5X125	9009020000
<b>Crimping tool</b>	
PZ 6/5	9011460000

**Ordering data**

Solder pin length				
Colour	Black			
Pitch	7.62 mm			
Pol.	L1	(inch)	Qty.	Order No.
2	15.24	0.600	65	1060550000
3	22.86	0.900	50	1060570000
4	30.48	1.200	40	1430120000
5	38.10	1.500	30	1430130000
6	45.72	1.800	25	2629920000

**Representative deratings curve**

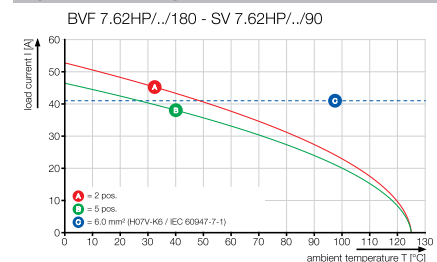

BVF 7.62HP/./180MF3



Dimensioned drawing

BVF 7.62HP/./180MF4



Dimensioned drawing

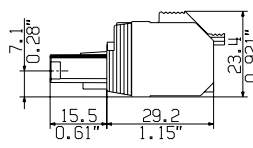
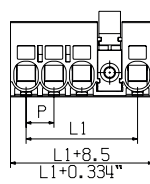
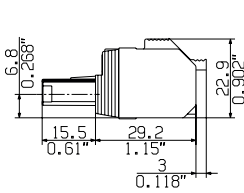
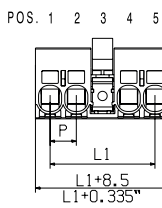

Ordering data

Solder pin length					
Colour					Black
Pitch 7.62 mm					
Pol.	L1	(inch)	Qty.	Order No.	
3	22.86	0.900	50	1060580000	
4	30.48	1.200	40	1060590000	
5	38.10	1.500	30	1060600000	
6	45.72	1.800	25	2630270000	

Ordering data

Solder pin length					
Colour					Black
Pitch 7.62 mm					
Pol.	L1	(inch)	Qty.	Order No.	
4	30.48	1.200	40	1430140000	
5	38.10	1.500	30	1060610000	
6	45.72	1.800	25	1060620000	



Additional deratings curves

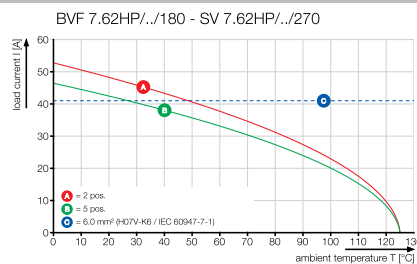
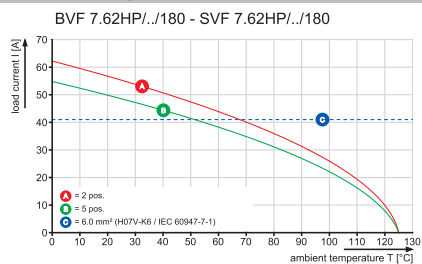

**Plug-in connector, pitch 7.62 mm**  
**BV/SV 7.62 series - connection up to 6 mm<sup>2</sup>**

**BVF 7.62HP../180MSF**

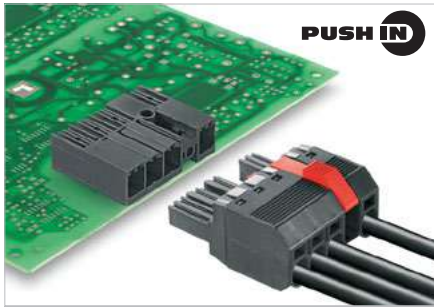

Female plug in 180° outlet direction with "PUSH IN" spring connection for TNC (S) systems. Meets the requirements of UL1059 for 600 V Use Group C. The mating profile ensures touch-safety of > 3 mm in accordance with IEC 61800-5-1.

Maximum operational reliability with a derating up to 125°C, a mating profile that can only be plugged in correct, and unique coding capability.

- Middle flange available in positions 2, 3 and 4.

**Technical data**

**In compliance with IEC 60664-1 / IEC 61984**

Clamping range, max.	mm <sup>2</sup>	0.5...10
<b>Solid core H05(07) V-U</b>	<b>mm<sup>2</sup></b>	<b>0.5...10</b>
Stranded H07 V-R		...10
Flexible H05(07) V-K	mm <sup>2</sup>	0.5...10
Flexible with ferrule	mm <sup>2</sup>	1.5...10
Ferrule with plastic collar	mm <sup>2</sup>	1.5...6
Stripping length	mm	12
Screwdriver blade	mm	0.6 x 3.5

According to norm

Tightening torque range			
<b>Rated current, max.</b>	<b>A</b>	<b>57</b>	<b>57</b>
At ambient temperature		20°C	40°C
For conductor cross-section	mm <sup>2</sup>	6	
Overvoltage category		III	III II
Pollution severity		3	2 2

<b>Rated voltage</b>	<b>V</b>	<b>800</b>	<b>1000</b>	<b>1000</b>
Rated impulse voltage	kV	8	8	6

**UL / CUL (Use Group)**

<b>Rated voltage</b>	<b>V</b>	<b>600</b>	<b>600</b>	<b>600</b>
----------------------	----------	------------	------------	------------

<b>Rated current</b>	<b>A</b>	<b>39</b>	<b>39</b>	<b>5</b>
----------------------	----------	-----------	-----------	----------

<b>AWG conductor</b>	<b>AWG</b>	<b>24-8</b>
----------------------	------------	-------------

**CSA (Use Group)**

<b>Rated voltage</b>	<b>V</b>	<b>600</b>	<b>600</b>	<b>600</b>
----------------------	----------	------------	------------	------------

<b>Rated current</b>	<b>A</b>	<b>33</b>	<b>33</b>	<b>5</b>
----------------------	----------	-----------	-----------	----------

<b>AWG conductor</b>	<b>AWG</b>	<b>24-8</b>
----------------------	------------	-------------

**General data**

Type of insulation material		PA GF
UL 94 flammability rating		V-0
Contact base material		Copper alloy
Material of contact surface		tinned
Pin dimensions = d	mm	
Solder eyelet Ø = D	mm	
Solder eyelet Ø tolerance	mm	

**Product data**

IEC: 1000 V / 57 A / 0.5 - 10 mm<sup>2</sup>  
 UL: 600 V / 39 A / AWG 24 - 8



For additional articles and information, refer to [catalog.weidmuller.com](http://catalog.weidmuller.com)

**Note:**

- Additional colours on request
- Wire end ferrule with plastic collar to DIN 46228/4
- Wire end ferrule without plastic collar to DIN 46228/1
- P on drawing = pitch
- Rated data refer only to the component itself. Clearance and creepage distances to other components are to be designed in accordance with the relevant application standards.
- MFX and MSFX: X= Position of the middle flange e.g. MF2, MSF3
- Versions with pusher, see BVFL

**BVF 7.62HP../180MSF2**



**Dimensioned drawing**

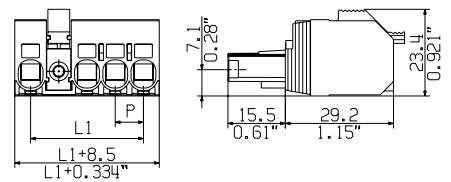

**Accessories**

**Note:** Refer to the Accessories chapter for additional accessories.

Coding		Order No.
	BV/SV 7.62HP K0	1937590000
<b>Screwdriver</b>		
	SDS 0.8X4.5X125	9009020000
<b>Crimping tool</b>		
	PZ 6/5	9011460000

**Ordering data**

**Solder pin length**

<b>Colour</b>	<b>Black</b>
---------------	--------------

**Pitch 7.62 mm**

Pol.	L1	(inch)	Qty.	Order No.
2	15.24	0.600	65	1060630000
3	22.86	0.900	50	1060640000
4	30.48	1.200	40	1430090000
5	38.10	1.500	30	1430100000

**Representative deratings curve**

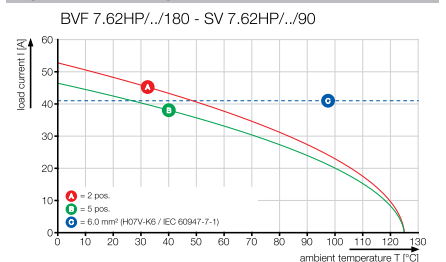



BVF 7.62HP../180MSF3



Dimensioned drawing

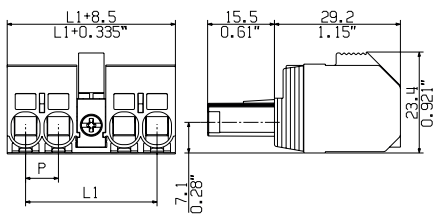

BVF 7.62HP../180MSF4



Dimensioned drawing

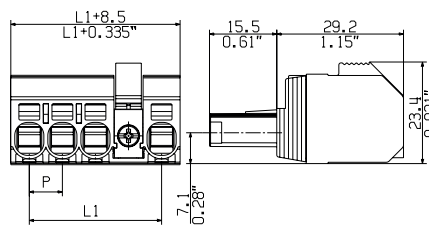

Ordering data

Solder pin length					
Colour					Black
Pitch 7.62 mm					
Pol.	L1	(inch)	Qty.	Order No.	
3	22.86	0.900	50	1060650000	
4	30.48	1.200	40	1060670000	
5	38.10	1.500	30	1060680000	
6	45.72	1.800	25	2630320000	

Ordering data

Solder pin length					
Colour					Black
Pitch 7.62 mm					
Pol.	L1	(inch)	Qty.	Order No.	
4	30.48	1.200	40	1430110000	
5	38.10	1.500	30	1060690000	
6	45.72	1.800	25	1060700000	



Additional deratings curves

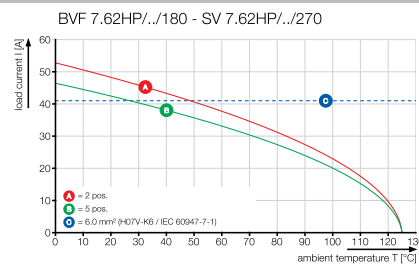
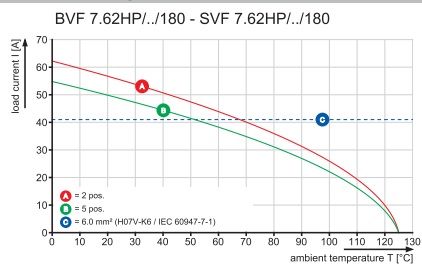

**Plug-in connector, pitch 7.62 mm**  
**BV/SV 7.62 series - connection up to 6 mm<sup>2</sup>**

**BVFL 7.62HP../180**

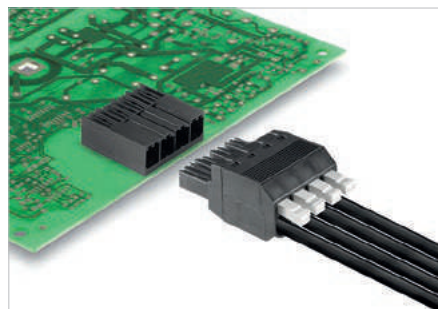

Female plug with 180° outlet direction, adjustable actuator (pusher) and PUSH IN spring connection technology for TNC(S) networks.  
 Meets the requirements of UL1059 for 600 V Use Group C. The pin arrangement ensures finger-safety of >3 mm in accordance with IEC 61800-5-1.

Maximum connection and operating reliability thanks to derating up to 125°C, unique coding diversity and a pin arrangement that ensures failsafe insertion.

Variants: flange, screw flange, middle flange and middle screw flange mounting.

**Product data**

IEC: 1000 V / 41 A / 0.5 - 6 mm<sup>2</sup>  
 UL: 600 V / 39 A / AWG 24 - 8



For additional articles and information, refer to [catalog.weidmueller.com](http://catalog.weidmueller.com)

**Note:**

- Additional colours on request
- Wire end ferrule with plastic collar to DIN 46228/4
- Wire end ferrule without plastic collar to DIN 46228/1
- P on drawing = pitch
- Rated data refer only to the component itself. Clearance and creepage distances to other components are to be designed in accordance with the relevant application standards.
- Additional pole combinations on request

**BVFL 7.62HP../180**



**Dimensioned drawing**

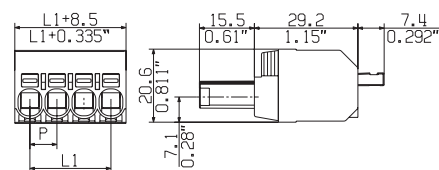

**Technical data**

In compliance with IEC 60664-1 / IEC 61984			
Clamping range, max.	mm <sup>2</sup>	0.5...6	
<b>Solid core H05(07) V-U</b>	<b>mm<sup>2</sup></b>	<b>0.5...6</b>	
Stranded H07 V-R			
Flexible H05(07) V-K	mm <sup>2</sup>	0.5...6	
Flexible with ferrule	mm <sup>2</sup>	1.5...6	
Ferrule with plastic collar	mm <sup>2</sup>	1.5...6	
Stripping length	mm	12	
Screwdriver blade	mm	0.6 x 3.5	
According to norm			
Tightening torque range			
<b>Rated current, max.</b>	<b>A</b>	<b>41</b>	<b>41</b>
At ambient temperature		20°C	40°C
For conductor cross-section	mm <sup>2</sup>	6	
Overvoltage category		III	III II
Pollution severity		3	2 2
<b>Rated voltage</b>	<b>V</b>	<b>800</b>	<b>1000 1000</b>
Rated impulse voltage	kV	8	8 6
<b>UL / CUL (Use Group)</b>		<b>B</b>	<b>C D</b>
<b>Rated voltage</b>	<b>V</b>	<b>600</b>	<b>600 600</b>
<b>Rated current</b>	<b>A</b>	<b>39</b>	<b>39 5</b>
<b>AWG conductor</b>	<b>AWG</b>		<b>24-8</b>
<b>CSA (Use Group)</b>		<b>B</b>	<b>C D</b>
Rated voltage	V	600	600 600
Rated current	A	33	33 5
AWG conductor	AWG		24-8
General data			
Type of insulation material		PA GF	
UL 94 flammability rating		V-0	
Contact base material		Copper alloy	
Material of contact surface		tinned	
Pin dimensions = d	mm		
Solder eyelet Ø = D			
Solder eyelet Ø tolerance	mm		

**Accessories**

**Note:** Refer to the Accessories chapter for additional accessories.

Coding		Order No.
	BV/SV 7.62HP K0	1937590000
<b>Crimping tool</b>		
	PZ 6/5	9011460000
<b>Coupling set</b>		
	SVF/BVF 7.62HP COUPLE SET	1440850000
<b>Screwdriver</b>		
	SDS 0.6X3.5X100	9008330000

**Ordering data**

Solder pin length				
Colour	Black			
Pitch	7.62 mm			
Pol.	L1	(inch)	Qty.	Order No.
2	7.62	0.300	114	2548870000
3	15.24	0.600	78	2548880000
4	22.86	0.900	60	1547520000
5	30.48	1.200	42	2548890000

**Representative deratings curve**

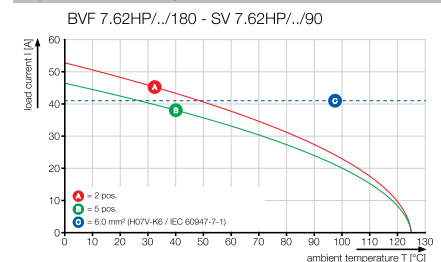

BVFL 7.62HP../180F



Dimensioned drawing

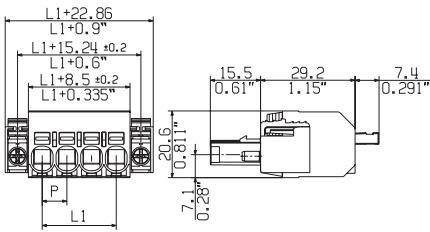

Ordering data

Solder pin length				
Colour				Black
Pitch		7.62 mm		
Pol.	L1	(inch)	Qty.	Order No.
2	7.62	0.300	40	2549280000
3	15.24	0.600	40	2549340000
4	22.86	0.900	32	1547530000
5	30.48	1.200	25	2549350000



Additional deratings curves

BVF 7.62HP../180 - SV 7.62HP../270

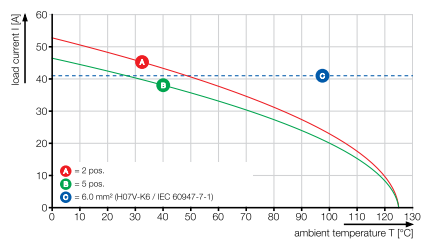

**Plug-in connector, pitch 7.62 mm**  
**BV/SV 7.62 series - connection up to 6 mm<sup>2</sup>**

**BVFL 7.62HP../180MF**

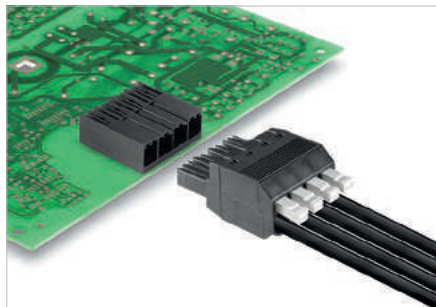

Female plug with 180° outlet direction, adjustable actuator (pusher) and PUSH IN spring connection technology for TNC(S) networks.  
 Meets the requirements of UL1059 for 600 V Use Group C. The pin arrangement ensures finger-safety of >3 mm in accordance with IEC 61800-5-1.

Maximum connection and operating reliability thanks to derating up to 125°C, unique coding diversity and a pin arrangement that ensures failsafe insertion.

Variants: flange, screw flange, middle flange and middle screw flange mounting.

**Product data**

IEC: 1000 V / 41 A / 0.5 - 6 mm<sup>2</sup>  
 UL: 600 V / 39 A / AWG 24 - 8



For additional articles and information, refer to [catalog.weidmueller.com](http://catalog.weidmueller.com)

**Note:**

- Additional colours on request
- Wire end ferrule with plastic collar to DIN 46228/4
- Wire end ferrule without plastic collar to DIN 46228/1
- P on drawing = pitch
- Rated data refer only to the component itself. Clearance and creepage distances to other components are to be designed in accordance with the relevant application standards.
- Additional pole combinations on request

**BVFL 7.62HP../180MF2**



**Dimensioned drawing**

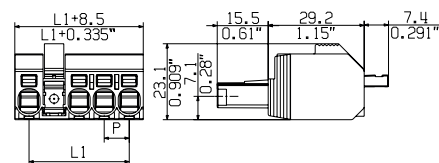

**Technical data**

In compliance with IEC 60664-1 / IEC 61984			
Clamping range, max.	mm <sup>2</sup>	0.5...6	
<b>Solid core H05(07) V-U</b>	<b>mm<sup>2</sup></b>	<b>0.5...6</b>	
Stranded H07 V-R			
Flexible H05(07) V-K	mm <sup>2</sup>	0.5...6	
Flexible with ferrule	mm <sup>2</sup>	1.5...6	
Ferrule with plastic collar	mm <sup>2</sup>	1.5...6	
Stripping length	mm	12	
Screwdriver blade	mm	0.6 x 3.5	
According to norm			
Tightening torque range			
<b>Rated current, max.</b>	<b>A</b>	<b>41</b>	<b>41</b>
At ambient temperature		20°C	40°C
For conductor cross-section	mm <sup>2</sup>	6	
Overvoltage category		III	III II
Pollution severity		3	2 2
<b>Rated voltage</b>	<b>V</b>	<b>800</b>	<b>1000 1000</b>
Rated impulse voltage	kV	8	8 6
<b>UL / CUL (Use Group)</b>		<b>B</b>	<b>C D</b>
<b>Rated voltage</b>	<b>V</b>	<b>600</b>	<b>600 600</b>
<b>Rated current</b>	<b>A</b>	<b>39</b>	<b>39 5</b>
<b>AWG conductor</b>	<b>AWG</b>	<b>24-8</b>	
<b>CSA (Use Group)</b>		<b>B</b>	<b>C D</b>
Rated voltage	V	600	600 600
Rated current	A	33	33 5
AWG conductor	AWG	24-8	
General data			
Type of insulation material		PA GF	
UL 94 flammability rating		V-0	
Contact base material		Copper alloy	
Material of contact surface		tinned	
Pin dimensions = d	mm		
Solder eyelet Ø = D			
Solder eyelet Ø tolerance	mm		

**Accessories**

**Note:** Refer to the Accessories chapter for additional accessories.

Coding	Order No.
BV/SV 7.62HP K0	1937590000
<b>Crimping tool</b>	
PZ 6/5	9011460000
<b>Coupling set</b>	
SVF/BVF 7.62HP COUPLE SET	1440850000
<b>Screwdriver</b>	
SDS 0.6X3.5X100	9008330000

**Ordering data**

Solder pin length				
Colour	Black			
Pitch	7.62 mm			
Pol.	L1	(inch)	Qty.	Order No.
2	15.24	0.600	52	2549300000
3	22.86	0.900	45	2549360000
4	30.48	1.200	40	2630700000
5	38.10	1.500	30	2630710000
6	45.72	1.800	25	2630720000

**Representative deratings curve**

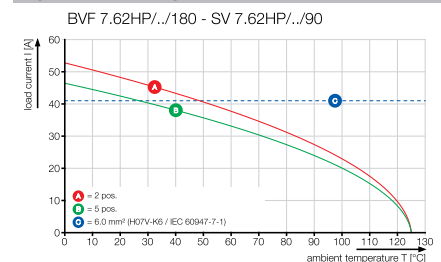

**BVFL 7.62HP../180MF3**



Dimensioned drawing

**BVFL 7.62HP../180MF4**



Dimensioned drawing

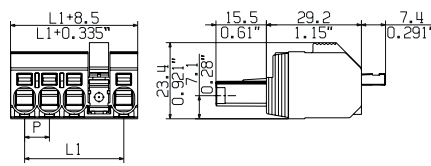
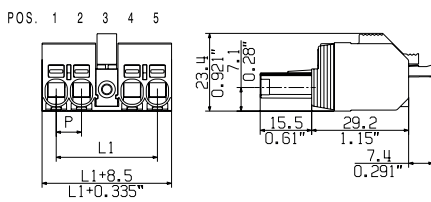

**Ordering data**

Solder pin length					
Colour					Black
Pitch 7.62 mm					
Pol.	L1	(inch)	Qty.	Order No.	
3	22.86	0.900	45	2549370000	
4	30.48	1.200	20	1547540000	
5	38.10	1.500	30	2549380000	
6	45.72	1.800	25	2630730000	

**Ordering data**

Solder pin length					
Colour					Black
Pitch 7.62 mm					
Pol.	L1	(inch)	Qty.	Order No.	
4	30.48	1.200	40	2630740000	
5	38.10	1.500	30	2549390000	



**Additional deratings curves**

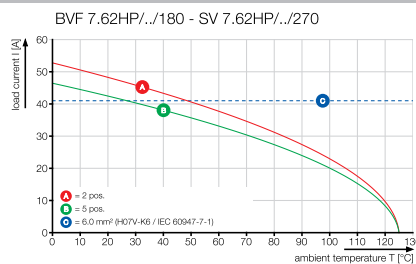
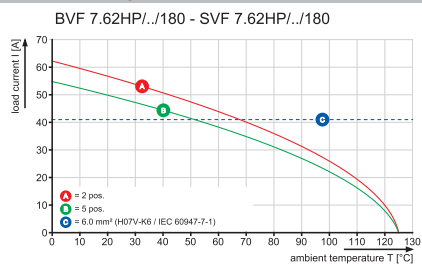

**Plug-in connector, pitch 7.62 mm**  
**BV/SV 7.62 series - connection up to 6 mm<sup>2</sup>**

**BVL 7.62HP../90**

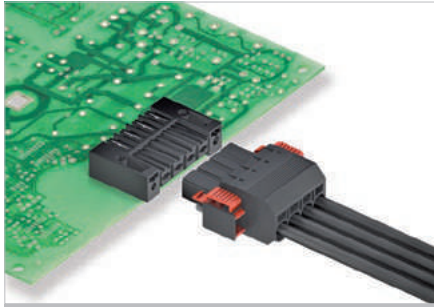

Touch-safe female header with 90° outlet direction for PCBs. Meets the requirements of IEC 61800-5-1 and comes with UL approval in accordance with UL508-5-1 / UL840 for 600 V. An ideal touch-safe solution for power output and DC-link applications. The pin arrangement ensures more than 3 mm of touch-safety in accordance with IEC 61800-5-1.

Maximum connection and operating reliability thanks to: derating up to 125°C, pin arrangement that prevents wrong connections or incorrect wiring, and unique coding diversity.

Variants: flange and screw flange fastening.

**Technical data**

**In compliance with IEC 60664-1 / IEC 61984**

Clamping range, max.			
<b>Solid core H05(07) V-U</b>			
Stranded H07 V-R			
Flexible H05(07) V-K			
Flexible with ferrule			
Ferrule with plastic collar			
Stripping length			
Screwdriver blade	mm		
According to norm			
Tightening torque range			
<b>Rated current, max.</b>	<b>A</b>	<b>56.8</b>	<b>41</b>
At ambient temperature		20°C	40°C
For conductor cross-section			
Overtoltage category		III	III
Pollution severity		3	2
<b>Rated voltage</b>	<b>V</b>	<b>630</b>	<b>630</b>
Rated impulse voltage	kV	6	6
<b>UL / CUL (Use Group)</b>		<b>B</b>	<b>C</b>
<b>Rated voltage</b>	<b>V</b>	<b>300</b>	<b>300</b>
<b>Rated current</b>	<b>A</b>	<b>35</b>	<b>35</b>
<b>AWG conductor</b>	<b>AWG</b>		
<b>CSA (Use Group)</b>		<b>B</b>	<b>C</b>
Rated voltage	V	300	300
Rated current	A	35	35
AWG conductor	AWG		
<b>General data</b>			
Type of insulation material		PA GF	
UL 94 flammability rating		V-0	
Contact base material		Copper alloy	
Material of contact surface		tinned	
Pin dimensions = d	mm	0.8 x 1.0	
Solder eyelet Ø = D	mm	1.3	
Solder eyelet Ø tolerance	mm	+ 0,1	

**Product data**

IEC: 1000 V / 56.8 A  
 UL: 300 V / 35 A



For additional articles and information, refer to [catalog.weidmueller.com](http://catalog.weidmueller.com)

**Note:**

- Additional colours on request
- Rated current related to rated cross-section & min. No. of poles.
- P on drawing = pitch
- Rated data refer only to the component itself. Clearance and creepage distances to other components are to be designed in accordance with the relevant application standards.

**BVL 7.62HP../90**



**Dimensioned drawing**

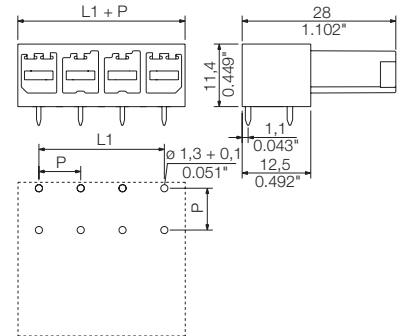

**Ordering data**

<b>Solder pin length</b>	3.5 mm		
<b>Colour</b>	Black		
<b>Pitch</b>	7.62 mm		
<b>Pol.</b>	<b>L1</b>	<b>(inch)</b>	<b>Qty.</b>
2	7.62	0.300	100
3	15.24	0.600	100
4	22.86	0.900	100
5	30.48	1.200	50
6	38.10	1.500	50
7	45.72	1.800	50
			<b>Order No.</b>
			1928280000
			1928290000
			1928300000
			1928310000
			1928320000
			1928330000

**Accessories**

**Note:** Refer to the Accessories chapter for additional accessories.

<b>Coding</b>	<b>Order No.</b>
BV/SV 7.62HP K0	1937590000

**Representative deratings curve**

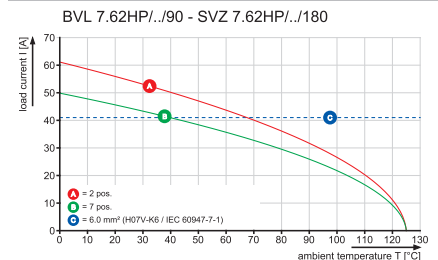

**BVL 7.62HP../90FI**



Dimensioned drawing

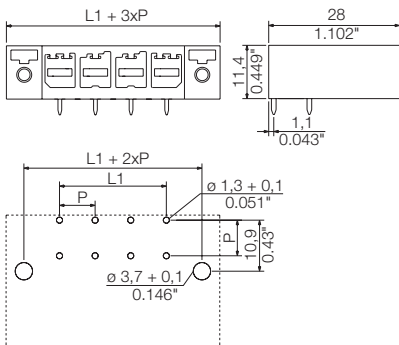

**Ordering data**

Solder pin length		3.5 mm		
Colour		Black		
Pitch		7.62 mm		
Pol.	L1	(inch)	Qty.	Order No.
2	7.62	0.300	100	1928390000
3	15.24	0.600	100	1928400000
4	22.86	0.900	100	1928410000
5	30.48	1.200	50	1928420000
6	38.10	1.500	50	1928430000
7	45.72	1.800	50	1928440000

**BVL 7.62HP../90SFI**



Dimensioned drawing

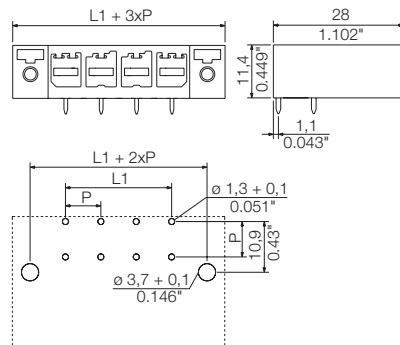

**Ordering data**

Solder pin length		3.5 mm		
Colour		Black		
Pitch		7.62 mm		
Pol.	L1	(inch)	Qty.	Order No.
2	7.62	0.300	100	1928500000
3	15.24	0.600	100	1928510000
4	22.86	0.900	100	1928520000
5	30.48	1.200	50	1928530000
6	38.10	1.500	50	1928540000
7	45.72	1.800	50	1928550000



**Additional deratings curves**

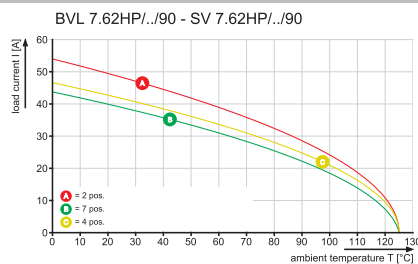
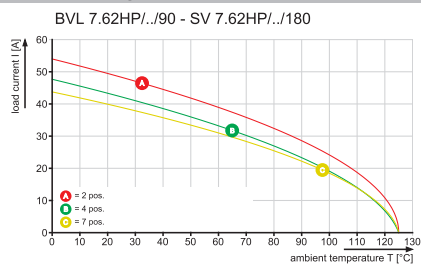

**Plug-in connector, pitch 7.62 mm**  
**BV/SV 7.62 series - connection up to 6 mm<sup>2</sup>**

**BVL 7.62HP../180**

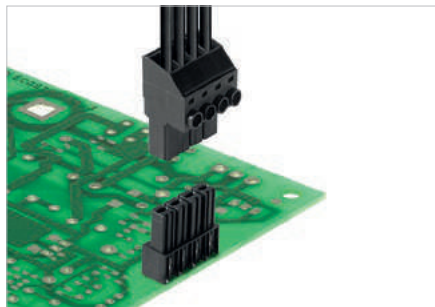

Touch-safe female header with 180° outlet direction for PCBs. Meets the requirements of IEC 61800-5-1 and comes with UL approval in accordance with UL508-5-1 / UL840 for 600 V. An ideal touch-safe solution for power output and DC-link applications. The pin arrangement ensures more than 3 mm of touch-safety in accordance with IEC 61800-5-1.

Characteristics: derating up to 125°C, pin arrangement that prevents wrong connections or incorrect wiring, unique coding diversity, additional fixing and integral positioning aid.

Variants: flange and screw flange fastening.

**Product data**

IEC: 1000 V / 56.8 A  
 UL: 300 V / 42 A



For additional articles and information, refer to [catalog.weidmueller.com](http://catalog.weidmueller.com)

**Note:**

- Additional colours on request
- Rated current related to rated cross-section & min. No. of poles.
- P on drawing = pitch
- Rated data refer only to the component itself. Clearance and creepage distances to other components are to be designed in accordance with the relevant application standards.

**BVL 7.62HP../180**



**Dimensioned drawing**

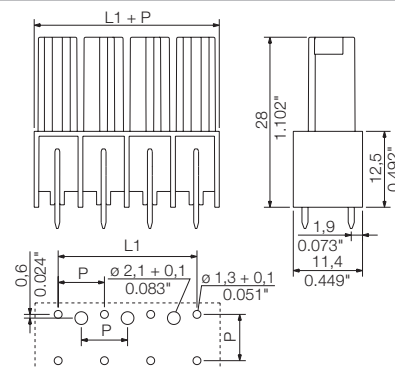

**Technical data**

**In compliance with IEC 60664-1 / IEC 61984**

Clamping range, max.			
<b>Solid core H05(07) V-U</b>			
Stranded H07 V-R			
Flexible H05(07) V-K			
Flexible with ferrule			
Ferrule with plastic collar			
Stripping length			
Screwdriver blade	mm		
According to norm			
Tightening torque range			
<b>Rated current, max.</b>	<b>A</b>	<b>56.8</b>	<b>41</b>
At ambient temperature		20°C	40°C
For conductor cross-section			
Overtoltage category		III	III II
Pollution severity		3	2 2
<b>Rated voltage</b>	<b>V</b>	<b>630</b>	<b>630 1000</b>
Rated impulse voltage	kV	6	6 6
<b>UL / CUL (Use Group)</b>		<b>B</b>	<b>C D</b>
<b>Rated voltage</b>	<b>V</b>	<b>300</b>	<b>300 600</b>
<b>Rated current</b>	<b>A</b>	<b>42</b>	<b>42 5</b>
<b>AWG conductor</b>	<b>AWG</b>	-	
<b>CSA (Use Group)</b>		<b>B</b>	<b>C D</b>
Rated voltage	V	300	300 600
Rated current	A	35	35 5
AWG conductor	AWG	-	
<b>General data</b>			
Type of insulation material		PA GF	
UL 94 flammability rating		V-0	
Contact base material		Copper alloy	
Material of contact surface		tinned	
Pin dimensions = d	mm	0.8 x 1.0	
Solder eyelet Ø = D	mm	1.3	
Solder eyelet Ø tolerance	mm	+ 0,1	

**Accessories**

**Note:** Refer to the Accessories chapter for additional accessories.

Coding		Order No.
	BV/SV 7.62HP K0	1937590000
<b>Protection against twisting</b>		
	VDS180 SV7.62	1853940000

**Ordering data**

<b>Solder pin length</b>	3.5 mm			
<b>Colour</b>	Black			
<b>Pitch</b>	7.62 mm			
Pol.	L1	(inch)	Qty.	Order No.
2	7.62	0.300	100	1928610000
3	15.24	0.600	100	1928620000
4	22.86	0.900	100	1928630000
5	30.48	1.200	50	1928650000
6	38.10	1.500	50	1928660000
7	45.72	1.800	50	1928670000

**Representative deratings curve**

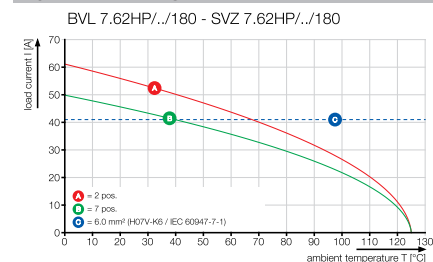



BVL 7.62HP../180FI



Dimensioned drawing

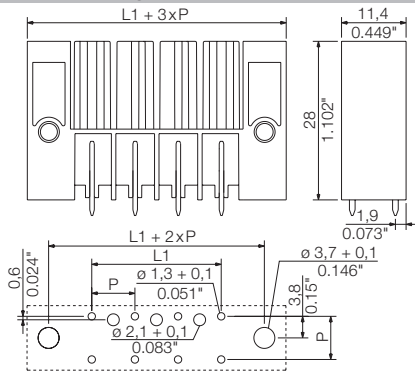

Ordering data

Solder pin length		3.5 mm		
Colour		Black		
Pitch		7.62 mm		
Pol.	L1	(inch)	Qty.	Order No.
2	7.62	0.300	100	1928730000
3	15.24	0.600	100	1928740000
4	22.86	0.900	100	1928750000
5	30.48	1.200	50	1928760000
6	38.10	1.500	50	1928770000
7	45.72	1.800	50	1928780000

BVL 7.62HP../180SFI



Dimensioned drawing

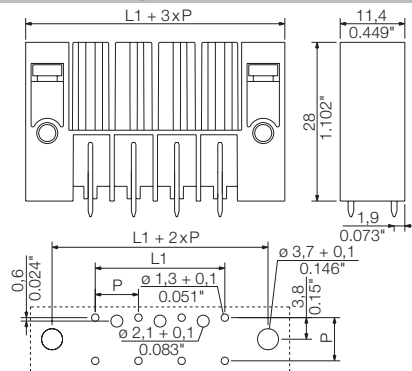

Ordering data

Solder pin length		3.5 mm		
Colour		Black		
Pitch		7.62 mm		
Pol.	L1	(inch)	Qty.	Order No.
2	7.62	0.300	100	1928840000
3	15.24	0.600	100	1928850000
4	22.86	0.900	100	1928860000
5	30.48	1.200	50	1928870000
6	38.10	1.500	50	1928900000
7	45.72	1.800	50	1928910000



Additional deratings curves

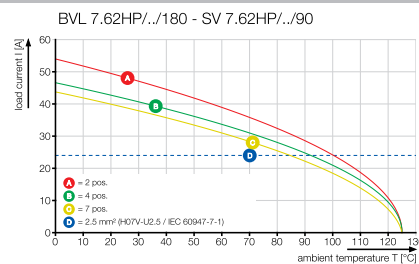
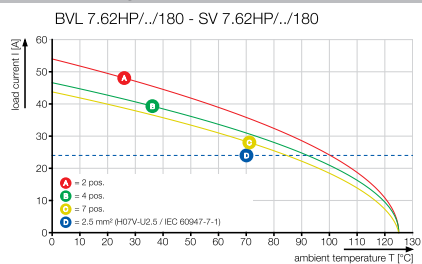

**Plug-in connector, pitch 7.62 mm**  
**BV/SV 7.62 series - connection up to 6 mm<sup>2</sup>**

**BVL 7.62HP../270**

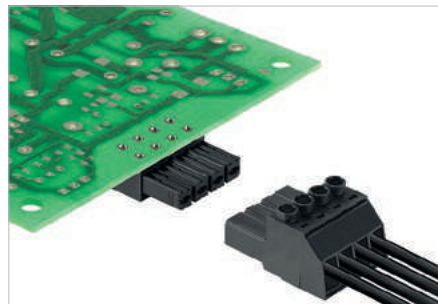

Finger-safe female header with 270° outlet direction for PCBs. Meets the requirements of IEC 61800-5-1 and comes with UL approval in accordance with UL508-5-1 / UL840 for 600 V. An ideal touch-safe solution for power output and DC-link applications. The pin arrangement ensures more than 3 mm of touch-safety in accordance with IEC 61800-5-1.

Maximum connection and operating reliability thanks to: derating up to 125°C, pin arrangement that prevents wrong connections or incorrect wiring, and unique coding diversity.

Variants: flange and screw flange fastening.

**Product data**

IEC: 1000 V / 56.8 A  
 UL: 300 V / 35 A



For additional articles and information, refer to [catalog.weidmueller.com](http://catalog.weidmueller.com)

**Note:**

- Additional colours on request
- Rated current related to rated cross-section & min. No. of poles.
- P on drawing = pitch
- Rated data refer only to the component itself. Clearance and creepage distances to other components are to be designed in accordance with the relevant application standards.

**BVL 7.62HP../270**



**Dimensioned drawing**

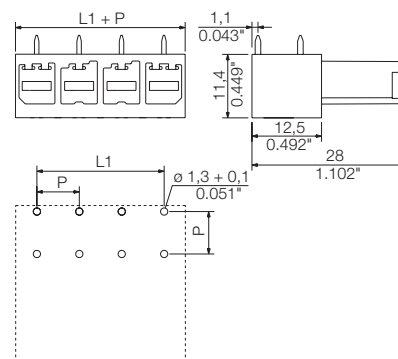

**Technical data**

**In compliance with IEC 60664-1 / IEC 61984**

Clamping range, max.			
<b>Solid core H05(07) V-U</b>			
Stranded H07 V-R			
Flexible H05(07) V-K			
Flexible with ferrule			
Ferrule with plastic collar			
Stripping length			
Screwdriver blade	mm		
According to norm			
Tightening torque range			
<b>Rated current, max.</b>	<b>A</b>	<b>56.8</b>	<b>41</b>
At ambient temperature		20°C	40°C
For conductor cross-section			
Overvoltage category		III	III
Pollution severity		3	2
<b>Rated voltage</b>	<b>V</b>	<b>630</b>	<b>630</b>
Rated impulse voltage	kV	6	6
<b>UL / CUL (Use Group)</b>		<b>B</b>	<b>C</b>
<b>Rated voltage</b>	<b>V</b>	<b>300</b>	<b>300</b>
<b>Rated current</b>	<b>A</b>	<b>35</b>	<b>35</b>
<b>AWG conductor</b>	<b>AWG</b>		
<b>CSA (Use Group)</b>		<b>B</b>	<b>C</b>
Rated voltage	V	300	300
Rated current	A	35	35
AWG conductor	AWG		
<b>General data</b>			
Type of insulation material		PA GF	
UL 94 flammability rating		V-0	
Contact base material		Copper alloy	
Material of contact surface		tinned	
Pin dimensions = d	mm	0.8 x 1.0	
Solder eyelet Ø = D	mm	1.3	
Solder eyelet Ø tolerance	mm	+ 0,1	

**Accessories**

**Note:** Refer to the Accessories chapter for additional accessories.

Coding	Order No.
BV/SV 7.62HP K0	1937590000



**Ordering data**

<b>Solder pin length</b>	3.5 mm			
<b>Colour</b>	Black			
<b>Pitch</b>	7.62 mm			
Pol.	L1	(inch)	Qty.	Order No.
2	7.62	0.300	100	1929300000
3	15.24	0.600	100	1929310000
4	22.86	0.900	100	1929320000
5	30.48	1.200	50	1929330000
6	38.10	1.500	50	1929340000
7	45.72	1.800	50	1929350000

**Representative deratings curve**

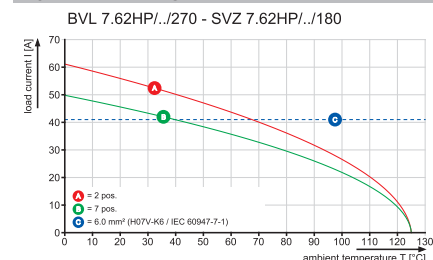

BVL 7.62HP../270FI

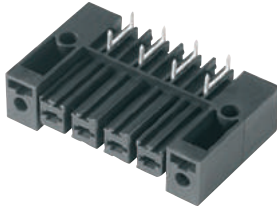

Dimensioned drawing

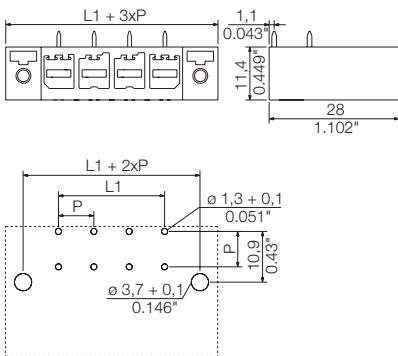

Ordering data

Solder pin length		3.5 mm		
Colour		Black		
Pitch		7.62 mm		
Pol.	L1	(inch)	Qty.	Order No.
2	7.62	0.300	100	1929410000
3	15.24	0.600	100	1929420000
4	22.86	0.900	100	1929430000
5	30.48	1.200	50	1929440000
6	38.10	1.500	50	1929450000
7	45.72	1.800	50	1929460000

BVL 7.62HP../270SFI

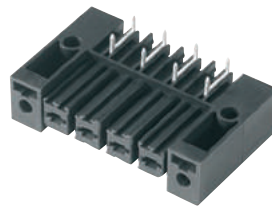

Dimensioned drawing

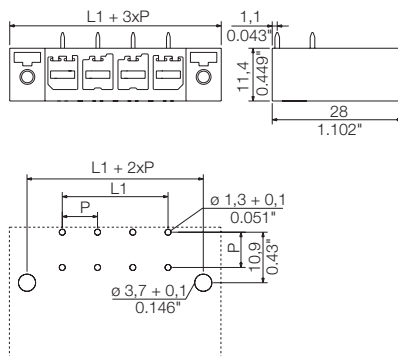

Ordering data

Solder pin length		3.5 mm		
Colour		Black		
Pitch		7.62 mm		
Pol.	L1	(inch)	Qty.	Order No.
2	7.62	0.300	100	1929520000
3	15.24	0.600	100	1929530000
4	22.86	0.900	100	1929540000
5	30.48	1.200	50	1929550000
6	38.10	1.500	50	1929560000
7	45.72	1.800	50	1929570000

Additional deratings curves

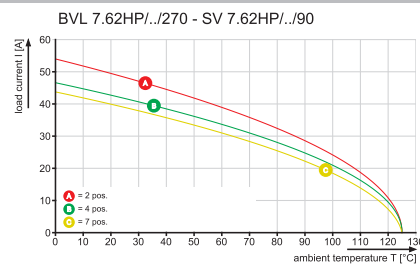
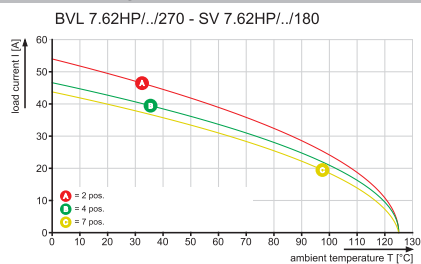

## Increased current for better performance

The top class in the OMNIMATE® Power SU / BUZ 10.16HP connector system features a very durable contact system which makes it a pluggable power transmission solution with maximum load reserves.

HP stands for High Performance – performance exemplified by a long-term usage temperature of 120 °C. This custom, pluggable solution is suitable for all applications that must meet 600 V UL or 1,000 V (IEC) with up to 76 A (IEC) and 54 A (UL).

### Compact reliability

Silver-plated contacts with stainless-steel top springs can tolerate short-circuit currents of 1,000 A for one second. Weidmüller's classic clamping yoke features a plus-minus screw and is protected against under insertion. It ensures a long-term, reliable connection.





**High system performance**

The OMNIMATE® Power System up to 16 mm<sup>2</sup> can be individually combined with plugging mates that have an interlocking flange. It is also possible for the plugging mate to be screwed on.

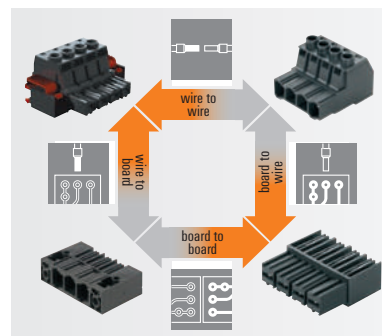

**Individualised configuration**

Clear printed labelling and customised coding are used to prevent damage that could be caused by installation mistakes.

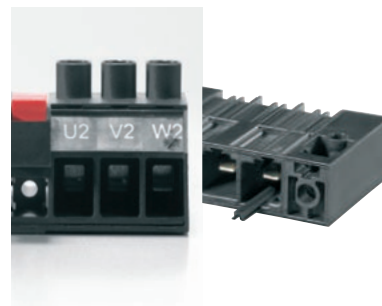

**Compact integration**

No compromises during design and approval: compact and standard-compliant with additional + 3.0 mm finger safety, according to IEC 61800-5-1, and increased creepage and clearance distances according to UL.

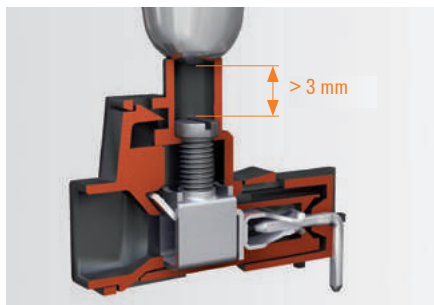

## Touch-safe female header for power electronics

### OMNIMATE® Power – plug-in connections for high power up to 76 A

Touch-safe protection for the contact blade is an important factor when considering high-power connectors. However such protection is currently quite difficult to design into standard products because of the size of the plug contacts.

We meet this challenge with our new BUL 10.16 female header in 10.16 mm pitch. The inverted plug ensures reliable touch protection for the unplugged, live side. This makes the BUL 10.16 a perfect-fit solution for board-to-wire connection in high-power electronics. You can also establish board-to-board connections when combined with the SU 10.16 HP standard male header.

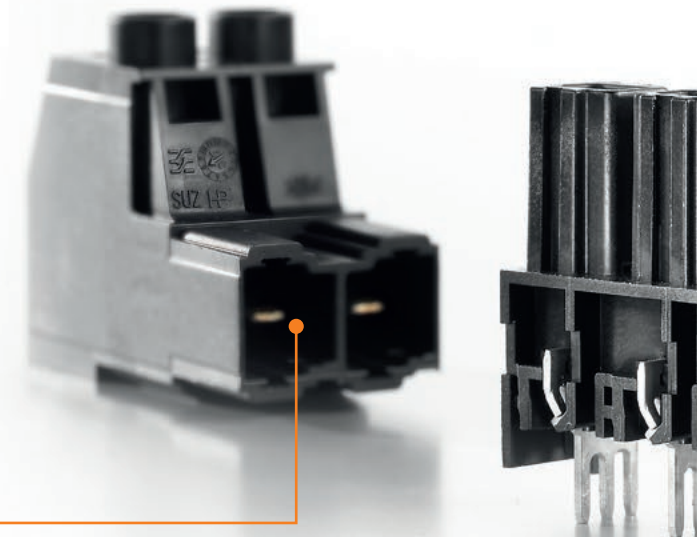

#### Cannot be wrongly inserted

Only mated plugs with the same pole count fit together. The plugs' mating profiles make it impossible to connect plugs with different pole counts together.



#### Plugging errors are not possible

With inserted coding elements, the male plug can only be connected with its corresponding female header.



**Non-rotating assembly**

Improved reliability while assembling the circuit board: An integrated coding pin serves as an assembly guide so that the plug cannot be accidentally turned 180°.

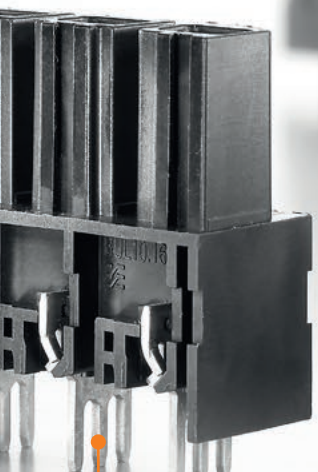

**High performance**

Three solder pins per pole provide the necessary mechanical strength while ensuring maximum current specifications.

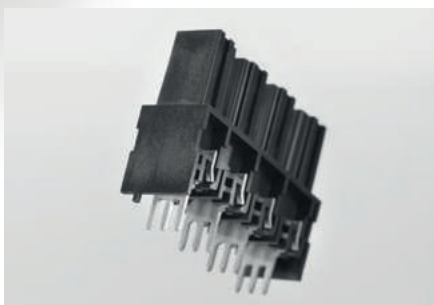



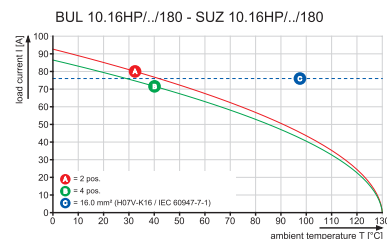

**Derating curve for the BUL 10.16 HP female header together with the SUZ 10.16 HP male plug**

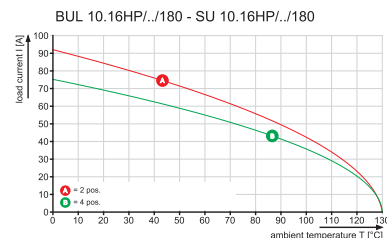

**Derating curve for the BUL 10.16 HP female header together with the SU 10.16 HP male header**



<http://www.OMNIMATE.net>

-  = Wire-to-Board
-  = Board-to-Board
-  = Wire-to-Wire
-  = Board-to-Wire

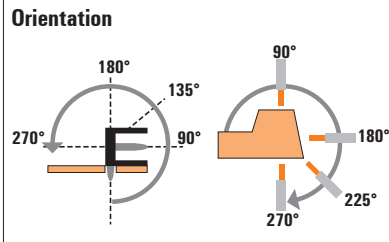
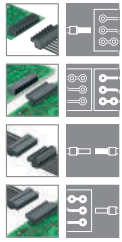

**BU/SU 10.16 series**



Type	Orientation	Flange options	Product code numbers
------	-------------	----------------	----------------------



	Type	Orientation	Flange options	Product code numbers	
Female plug	 <b>Screw Clamping yoke</b> 	BUZ	180°	(G)/F/SF	IEC: 1.000 V/78 A/0.2 - 16 mm <sup>2</sup> UL: 600 V/60 A/AWG 22 - 4
	 <b>Spring PUSH IN</b> 	BUF IT	180	(G)/F/SF	IEC: 1.000 V/78 A/0.2 - 16 mm <sup>2</sup> UL: 600 V/55 A/AWG 22 - 4
Female header	 <b>Solder connection</b> 	BUL	180°	on request	"IEC: 1.000 V/76 A UL: 300 V/57 A"

**Female:**  
 (G) = without flange  
 F = Interlock flange  
 SF = Interlock flange with screw

**Pin:**  
 G = Closed (without flange)  
 F = Interlock flange  
 SF = Interlock flange with nut

K



Male header	Male plug
 <b>Solder connection</b>	 <b>Screw Clamping yoke</b>



SU	SU	SU	SUZ
90°	180°	270°	180°
G/F	G/F/SF	G/F/SF	G
IEC: 1.000 V/76 A UL: 300 V/54 A"	IEC: 1.000 V/76 A UL: 300 V/54 A"	IEC: 1.000 V/76 A UL: 300 V/54 A"	IEC: 1.000 V/78 A/0.2 - 16 mm <sup>2</sup> UL: 600 V/57 A/AWG 24 - 4
○	○	○	●
○	○	○	●
●	●	●	●

**Plug-in connector, pitch 10.16 mm**  
**BU/SU 10.16 series - connection up to 16 mm<sup>2</sup>**

**SU 10.16HP../90**

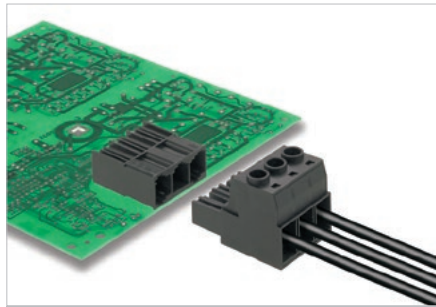

Male header with 90° outlet direction for TNC(S) systems. UL approval for 600 V in acc. with UL508-5-1 / UL840. The pin arrangement ensures more than 3 mm of touch-safety in acc. with IEC 61800-5-1.

Maximum connection and operating reliability thanks to: derating up to 125°C, pin arrangement that prevents wrong connections or incorrect wiring, and unique coding diversity.

Variants: flange and screw flange fastening.

**Product data**

IEC: 1000 V / 78.3 A  
UL: 300 V / 60 A



For additional articles and information, refer to [catalog.weidmueller.com](http://catalog.weidmueller.com)

**Note:**

- Additional colours on request
- Rated current related to rated cross-section & min. No. of poles.
- Wire end ferrule with plastic collar to DIN 46228/4
- Wire end ferrule without plastic collar to DIN 46228/1
- P on drawing = pitch
- Rated data refer only to the component itself. Clearance and creepage distances to other components are to be designed in accordance with the relevant application standards.

**SU 10.16HP../90G**

without flanges



**Dimensioned drawing**

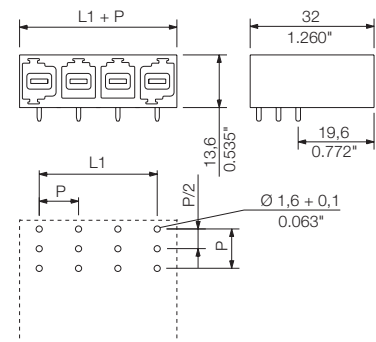

**Technical data**

**In compliance with IEC 60664-1 / IEC 61984**

Clamping range, max.			
<b>Solid core H05(07) V-U</b>			
Stranded H07 V-R			
Flexible H05(07) V-K			
Flexible with ferrule			
Ferrule with plastic collar			
Stripping length			
Screwdriver blade	mm		
According to norm			
Tightening torque range			
<b>Rated current, max.</b>	<b>A</b>	<b>78.3</b>	<b>70.6</b>
At ambient temperature		20°C	40°C
For conductor cross-section			
Overtoltage category		III	III II
Pollution severity		3	2 2
<b>Rated voltage</b>	<b>V</b>	<b>690</b>	<b>1000 1000</b>
Rated impulse voltage	kV	8	8 6
<b>UL / CUL (Use Group)</b>		<b>B</b>	<b>C D</b>

<b>Rated voltage</b>	<b>V</b>	<b>300</b>	<b>300</b>	<b>600</b>
<b>Rated current</b>	<b>A</b>	<b>60</b>	<b>60</b>	<b>5</b>
<b>AWG conductor</b>	<b>AWG</b>			
<b>CSA (Use Group)</b>		<b>B</b>	<b>C</b>	<b>D</b>
Rated voltage	V	300	300	600
Rated current	A	60	60	5
AWG conductor	AWG			

**General data**

Type of insulation material		PBT GF
UL 94 flammability rating		V-0
Contact base material		Copper alloy
Material of contact surface		silver-plated
Pin dimensions = d	mm	1.2 x 1.1
Solder eyelet Ø = D	mm	1.6
Solder eyelet Ø tolerance	mm	+ 0,1

**Accessories**

**Note:** Refer to the Accessories chapter for additional accessories.

Coding	Order No.
KO BU/SU10.16HP / BV/SV7.62	<b>18244 10000</b>
KO BU/SU10.16HP WT	<b>2592600000</b>

**Ordering data**

<b>Solder pin length</b>		<b>3.5 mm</b>		
<b>Colour</b>		<b>Black</b>		
<b>Pitch</b>		<b>10.16 mm</b>		
Pol.	L1	(inch)	Qty.	Order No.
2	10.16	0.400	90	<b>1813330000</b>
3	20.32	0.800	60	<b>1813340000</b>
4	30.48	1.200	42	<b>1813350000</b>
5	40.64	1.600	36	<b>1813360000</b>
6	50.80	2.000	30	<b>1813370000</b>
7	60.96	2.400	24	<b>1813380000</b>
8	71.12	2.800	18	<b>1813390000</b>
9	81.28	3.200	18	<b>1813400000</b>

### SU 10.16HP../.90F

#### Interlock flanges



Dimensioned drawing

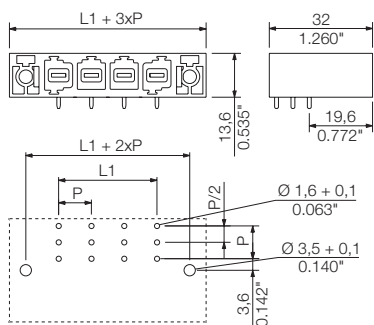

#### Ordering data

Solder pin length		3.5 mm		
Colour		Black		
Pitch		10.16 mm		
Pol.	L1	(inch)	Qty.	Order No.
2	10.16	0.400	42	1813570000
3	20.32	0.800	36	1813580000
4	30.48	1.200	30	1813590000
5	40.64	1.600	24	1813600000
6	50.80	2.000	18	1813610000
7	60.96	2.400	18	1813620000
8	71.12	2.800	18	1813630000
9	81.28	3.200	12	1813640000

### SU 10.16HP../.90SF

#### Interlock flanges with nuts



Dimensioned drawing

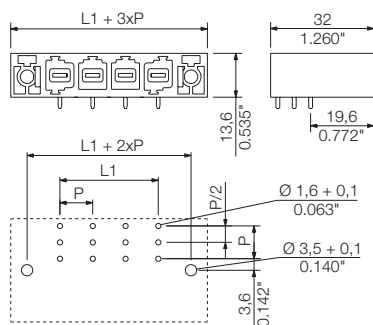

#### Ordering data

Solder pin length		3.5 mm		
Colour		Black		
Pitch		10.16 mm		
Pol.	L1	(inch)	Qty.	Order No.
2	10.16	0.400	42	1851040000
3	20.32	0.800	36	1851050000
4	30.48	1.200	30	1851060000
5	40.64	1.600	24	1851070000
6	50.80	2.000	18	1851080000
7	60.96	2.400	18	1851090000
8	71.12	2.800	18	1851100000
9	81.28	3.200	12	1851110000

**Plug-in connector, pitch 10.16 mm**  
**BU/SU 10.16 series - connection up to 16 mm<sup>2</sup>**

**SU 10.16HP../90MF**

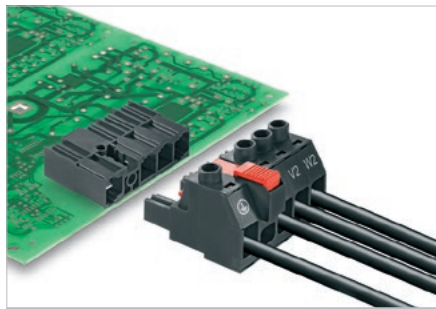

Male header in 90° outlet direction for TNC (S) systems. UL approved for 600 V in accordance with UL508 / UL840. The mating profile ensures touch-safety of more than 3 mm according to IEC 61800-5-1. Maximum operational reliability with a derating up to 125°C, a mating profile that can only be plugged in correct and unique coding capability.

- Available with a flange (F) and screw flange (SF).

**Technical data**

In compliance with IEC 60664-1 / IEC 61984

Clamping range, max.			
<b>Solid core H05(07) V-U</b>			
Stranded H07 V-R			
Flexible H05(07) V-K			
Flexible with ferrule			
Ferrule with plastic collar			
Stripping length			
Screwdriver blade	mm		
According to norm			
Tightening torque range			
<b>Rated current, max.</b>	<b>A</b>	<b>78.3</b>	<b>70.6</b>
At ambient temperature		20°C	40°C
For conductor cross-section			
Overtoltage category		III	III II
Pollution severity		3	2 2
<b>Rated voltage</b>	<b>V</b>	<b>690</b>	<b>1000 1000</b>
Rated impulse voltage	kV	8	8 6
<b>UL / CUL (Use Group)</b>		<b>B</b>	<b>C D</b>
<b>Rated voltage</b>	<b>V</b>	<b>300</b>	<b>300 600</b>
<b>Rated current</b>	<b>A</b>	<b>60</b>	<b>60 5</b>
<b>AWG conductor</b>	<b>AWG</b>		<b>-</b>
<b>CSA (Use Group)</b>		<b>B</b>	<b>C D</b>
Rated voltage	V	300	300 600
Rated current	A	60	60 5
AWG conductor	AWG		-
<b>General data</b>			
Type of insulation material		PBT GF	
UL 94 flammability rating		V-0	
Contact base material		Copper alloy	
Material of contact surface			
Pin dimensions = d	mm	1.2 x 1.1	
Solder eyelet Ø = D	mm	1.6	
Solder eyelet Ø tolerance	mm	+ 0,1	

**Product data**

IEC: 1000 V / 78.3 A  
UL: 300 V / 60 A



For additional articles and information, refer to [catalog.weidmuller.com](http://catalog.weidmuller.com)

**Note:**

- Additional colours on request
- Rated current related to rated cross-section & min. No. of poles.
- Wire end ferrule with plastic collar to DIN 46228/4
- Wire end ferrule without plastic collar to DIN 46228/1
- P on drawing = pitch
- Rated data refer only to the component itself. Clearance and creepage distances to other components are to be designed in accordance with the relevant application standards.
- MFX and MSFX: X= Position of the middle flange e.g. MF2, MSF3

**SU 10.16HP../90MF2**



**Dimensioned drawing**

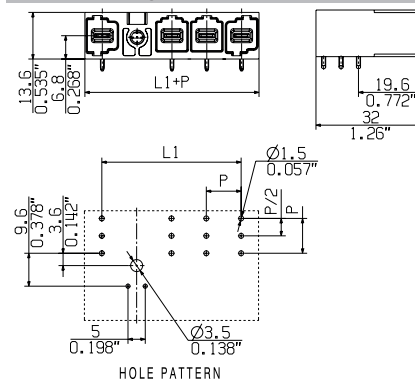

**Ordering data**

<b>Solder pin length</b>	3.5 mm			
<b>Colour</b>	Black			
<b>Pitch</b>	10.16 mm			
<b>Pol.</b>	<b>L1</b>	<b>(inch)</b>	<b>Qty.</b>	<b>Order No.</b>
2	20.32	0.800	60	2580340000
3	30.48	1.200	42	2580390000
4	40.64	1.600	36	2580410000
5	50.80	2.000	24	2597200000
6	60.96	2.400	20	2597210000

**Accessories**

Note: Refer to the Accessories chapter for additional accessories.

Coding	Order No.
KO BU/SU10.16HP / BV/SV7.62	1824410000
KO BU/SU10.16HP WT	2592600000

SU 10.16HP/..90MF3



Dimensioned drawing

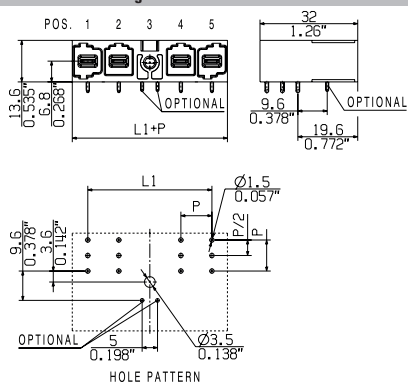

Ordering data

Solder pin length		3.5 mm	
Colour		Black	
Pitch		10.16 mm	
Pol.	L1	(inch)	Qty. Order No.
3	30.48	1.200	42 2580400000
4	40.64	1.600	36 2580420000
5	50.80	2.000	20 2597220000
6	60.96	2.400	20 2597230000

SU 10.16HP/..90MF4



Dimensioned drawing

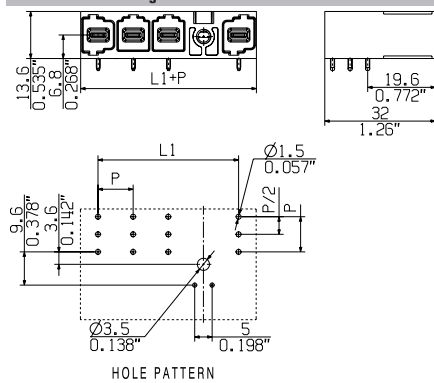

Ordering data

Solder pin length		3.5 mm	
Colour		Black	
Pitch		10.16 mm	
Pol.	L1	(inch)	Qty. Order No.
4	40.64	1.600	36 2580430000
5	50.80	2.000	20 2597240000
6	60.96	2.400	20 2597250000

Plug-in connector, pitch 10.16 mm  
BU/SU 10.16 series - connection up to 16 mm<sup>2</sup>

SU 10.16HP../180

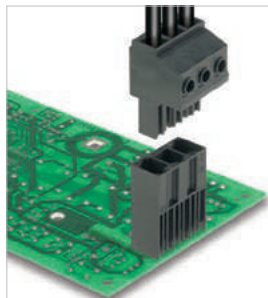

Male header with 180° outlet direction for TNC(S) systems. UL approval for 600 V in acc. with UL508-5-1 / UL840. The pin arrangement ensures more than 3 mm of touch-safety in acc. with IEC 61800-5-1.

Maximum connection and operating reliability thanks to: derating up to 125°C, pin arrangement that prevents wrong connections or incorrect wiring, unique coding diversity and integral positioning aid.

Variants: flange and screw flange fastening.

Product data

IEC: 1000 V / 78.3 A  
UL: 300 V / 60 A



For additional articles and information, refer to [catalog.weidmuller.com](http://catalog.weidmuller.com)

Note:

- Additional colours on request
- Rated current related to rated cross-section & min. No. of poles.
- Wire end ferrule with plastic collar to DIN 46228/4
- Wire end ferrule without plastic collar to DIN 46228/1
- P on drawing = pitch
- Rated data refer only to the component itself. Clearance and creepage distances to other components are to be designed in accordance with the relevant application standards.

SU 10.16HP../180G

without flanges



Dimensioned drawing

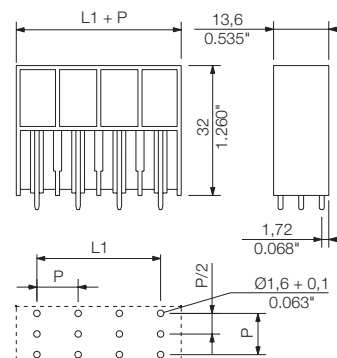

Technical data

In compliance with IEC 60664-1 / IEC 61984

Clamping range, max.			
<b>Solid core H05(07) V-U</b>			
Stranded H07 V-R			
Flexible H05(07) V-K			
Flexible with ferrule			
Ferrule with plastic collar			
Stripping length			
Screwdriver blade	mm		
According to norm			
Tightening torque range			
<b>Rated current, max.</b>	<b>A</b>	<b>78.3</b>	<b>70.6</b>
At ambient temperature		20°C	40°C
For conductor cross-section			
Overvoltage category		III	III II
Pollution severity		3	2 2
<b>Rated voltage</b>	<b>V</b>	<b>690</b>	<b>1000 1000</b>
Rated impulse voltage	kV	8	8 6
<b>UL / CUL (Use Group)</b>		<b>B</b>	<b>C D</b>
<b>Rated voltage</b>	<b>V</b>	<b>300</b>	<b>300 600</b>
<b>Rated current</b>	<b>A</b>	<b>60</b>	<b>60 5</b>
<b>AWG conductor</b>	<b>AWG</b>		<b>-</b>
<b>CSA (Use Group)</b>		<b>B</b>	<b>C D</b>
Rated voltage	V	300	300 600
Rated current	A	60	60 5
AWG conductor	AWG		-
<b>General data</b>			
Type of insulation material		PBT GF	
UL 94 flammability rating		V-0	
Contact base material		Copper alloy	
Material of contact surface		silver-plated	
Pin dimensions = d	mm	1.2 x 1.1	
Solder eyelet Ø = D	mm	1.6	
Solder eyelet Ø tolerance	mm	+ 0,1	

Accessories

Note: Refer to the Accessories chapter for additional accessories.

Protection against twisting		Order No.
	VDS180 SV7.62	1853940000
<b>Coding</b>		
	KO BU/SU10.16HP / BV/SV7.62	1824410000
	KO BU/SU10.16HP WT	2592600000

Ordering data

<b>Solder pin length</b>		3.5 mm		
<b>Colour</b>		Black		
<b>Pitch</b>		10.16 mm		
Pol.	L1	(inch)	Qty.	Order No.
2	10.16	0.400	90	1813410000
3	20.32	0.800	60	1813420000
4	30.48	1.200	42	1813430000
5	40.64	1.600	36	1813440000
6	50.80	2.000	30	1813450000
7	60.96	2.400	24	1813460000
8	71.12	2.800	18	1813470000
9	81.28	3.200	18	1813480000

### SU 10.16HP../180F

#### Interlock flanges



Dimensioned drawing

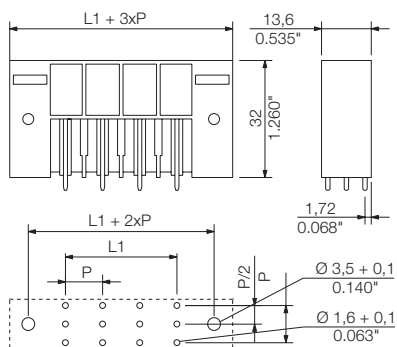

#### Ordering data

Solder pin length		3.5 mm	
Colour		Black	
Pitch		10.16 mm	
Pol.	L1	(inch)	Qty. Order No.
2	10.16	0.400	42 1813650000
3	20.32	0.800	36 1813660000
4	30.48	1.200	30 1813670000
5	40.64	1.600	24 1813680000
6	50.80	2.000	18 1813690000
7	60.96	2.400	18 1813700000
8	71.12	2.800	18 1813710000
9	81.28	3.200	12 1813720000

### SU 10.16HP../180SF

#### Interlock flanges with nuts



Dimensioned drawing

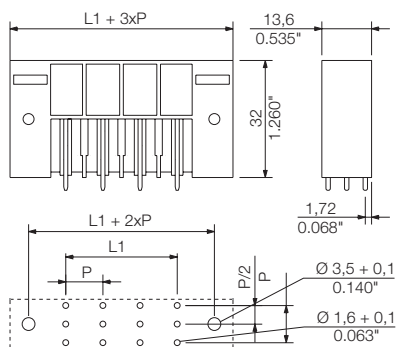

#### Ordering data

Solder pin length		3.5 mm	
Colour		Black	
Pitch		10.16 mm	
Pol.	L1	(inch)	Qty. Order No.
2	10.16	0.400	42 1850880000
3	20.32	0.800	36 1850890000
4	30.48	1.200	30 1850900000
5	40.64	1.600	24 1850910000
6	50.80	2.000	18 1850920000
7	60.96	2.400	18 1850930000
8	71.12	2.800	18 1850940000
9	81.28	3.200	12 1850950000

**Plug-in connector, pitch 10.16 mm**  
**BU/SU 10.16 series - connection up to 16 mm<sup>2</sup>**

**SU 10.16HP../270**

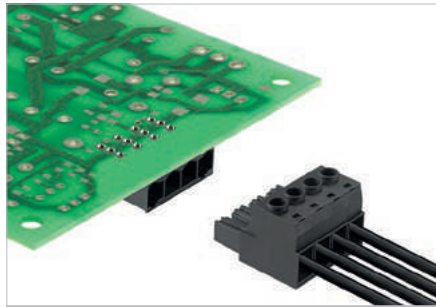

Male header with 270° outlet direction for TNC(S) systems. UL approval for 600 V in acc. with UL508-5-1 / UL840. The pin arrangement ensures more than 3 mm of touch-safety in acc. with IEC 61800-5-1.

Maximum connection and operating reliability thanks to: derating up to 125°C, pin arrangement that prevents wrong connections or incorrect wiring, and unique coding diversity.

Variants: flange and screw flange fastening.

**Product data**

IEC: 1000 V / 78.3 A  
UL: 300 V / 60 A



For additional articles and information, refer to [catalog.weidmueller.com](http://catalog.weidmueller.com)

**Note:**

- Additional colours on request
- Rated current related to rated cross-section & min. No. of poles.
- Wire end ferrule with plastic collar to DIN 46228/4
- Wire end ferrule without plastic collar to DIN 46228/1
- P on drawing = pitch
- Rated data refer only to the component itself. Clearance and creepage distances to other components are to be designed in accordance with the relevant application standards.

**SU 10.16HP../270G**

without flanges



**Dimensioned drawing**

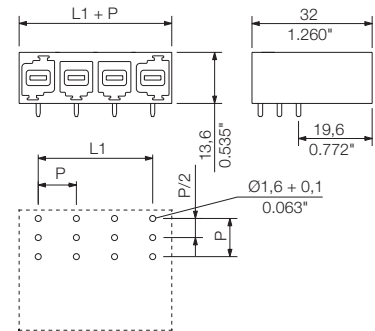

**Technical data**

In compliance with IEC 60664-1 / IEC 61984

Clamping range, max.			
<b>Solid core H05(07) V-U</b>			
Stranded H07 V-R			
Flexible H05(07) V-K			
Flexible with ferrule			
Ferrule with plastic collar			
Stripping length			
Screwdriver blade	mm		
According to norm			
Tightening torque range			
<b>Rated current, max.</b>	<b>A</b>	<b>78.3</b>	<b>70.6</b>
At ambient temperature		20°C	40°C
For conductor cross-section			
Overvoltage category		III	III II
Pollution severity		3	2 2
<b>Rated voltage</b>	<b>V</b>	<b>690</b>	<b>1000 1000</b>
Rated impulse voltage	kV	8	8 6
<b>UL / CUL (Use Group)</b>		<b>B</b>	<b>C D</b>
<b>Rated voltage</b>	<b>V</b>	<b>300</b>	<b>300 600</b>
<b>Rated current</b>	<b>A</b>	<b>60</b>	<b>60 5</b>
<b>AWG conductor</b>	<b>AWG</b>		<b>-</b>
<b>CSA (Use Group)</b>		<b>B</b>	<b>C D</b>
Rated voltage	V	300	300 600
Rated current	A	60	60 5
AWG conductor	AWG		-
<b>General data</b>			
Type of insulation material		PBT GF	
UL 94 flammability rating		V-0	
Contact base material		Copper alloy	
Material of contact surface		silver-plated	
Pin dimensions = d	mm	1.2 x 1.1	
Solder eyelet Ø = D	mm	1.6	
Solder eyelet Ø tolerance	mm	+ 0,1	

**Accessories**

Note: Refer to the Accessories chapter for additional accessories.

Coding	Order No.
 KO BU/SU10.16HP / BV/SV7.62	1824410000
KO BU/SU10.16HP WT	2592600000

**Ordering data**

<b>Solder pin length</b>		3.5 mm		
<b>Colour</b>		Black		
<b>Pitch</b>		10.16 mm		
Pol.	L1	(inch)	Qty.	Order No.
2	10.16	0.400	90	1813490000
3	20.32	0.800	60	1813500000
4	30.48	1.200	42	1813510000
5	40.64	1.600	36	1813520000
6	50.80	2.000	30	1813530000
7	60.96	2.400	24	1813540000
8	71.12	2.800	18	1813550000
9	81.28	3.200	18	1813560000



### SU 10.16HP/./270F

#### Interlock flanges

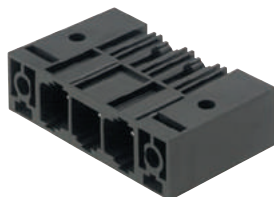

Dimensioned drawing

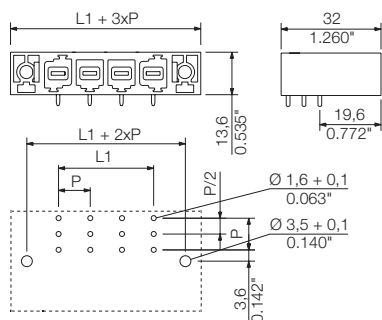

#### Ordering data

Solder pin length		3.5 mm		
Colour		Black		
Pitch		10.16 mm		
Pol.	L1	(inch)	Qty.	Order No.
2	10.16	0.400	42	1813730000
3	20.32	0.800	36	1813740000
4	30.48	1.200	30	1813750000
5	40.64	1.600	24	1813760000
6	50.80	2.000	18	1813770000
7	60.96	2.400	18	1813780000
8	71.12	2.800	18	1813790000
9	81.28	3.200	12	1813800000

### SU 10.16HP/./270SF

#### Interlock flanges with nuts

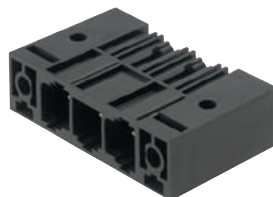

Dimensioned drawing

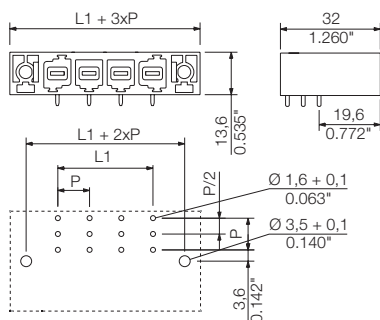

#### Ordering data

Solder pin length		3.5 mm		
Colour		Black		
Pitch		10.16 mm		
Pol.	L1	(inch)	Qty.	Order No.
2	10.16	0.400	42	1851120000
3	20.32	0.800	36	1851130000
4	30.48	1.200	30	1851140000
5	40.64	1.600	24	1851150000
6	50.80	2.000	18	1851160000
7	60.96	2.400	18	1851170000
8	71.12	2.800	18	1851180000
9	81.28	3.200	12	1851190000

**Plug-in connector, pitch 10.16 mm**  
**BU/SU 10.16 series - connection up to 16 mm<sup>2</sup>**

**SU 10.16HP../270MF**

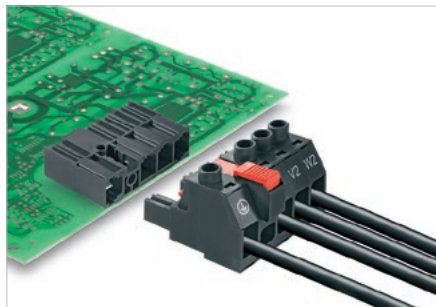

Male header with 270° outlet direction for TNC(S) systems. UL approval for 600 V in acc. with UL508-5-1 / UL840. The pin arrangement ensures more than 3 mm of touch-safety in acc. with IEC 61800-5-1.

Maximum connection and operating reliability thanks to: derating up to 125°C, pin arrangement that prevents wrong connections or incorrect wiring, and unique coding diversity.

Variants: flange and screw flange fastening.

**Product data**

IEC: 1000 V / 78.3 A  
UL: 300 V / 60 A



For additional articles and information, refer to [catalog.weidmueller.com](http://catalog.weidmueller.com)

**Note:**

- Additional colours on request
- Rated current related to rated cross-section & min. No. of poles.
- Wire end ferrule with plastic collar to DIN 46228/4
- Wire end ferrule without plastic collar to DIN 46228/1
- P on drawing = pitch
- Rated data refer only to the component itself. Clearance and creepage distances to other components are to be designed in accordance with the relevant application standards.

**SU 10.16HP../270MF2**



**Dimensioned drawing**

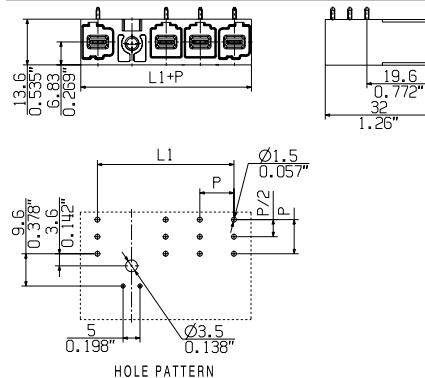

**Technical data**

**In compliance with IEC 60664-1 / IEC 61984**

Clamping range, max.			
<b>Solid core H05(07) V-U</b>			
Stranded H07 V-R			
Flexible H05(07) V-K			
Flexible with ferrule			
Ferrule with plastic collar			
Stripping length			
Screwdriver blade	mm		
According to norm			
Tightening torque range			
<b>Rated current, max.</b>	<b>A</b>	<b>78.3</b>	<b>70.6</b>
At ambient temperature		20°C	40°C
For conductor cross-section			
Overtoltage category		III	III
Pollution severity		3	2
<b>Rated voltage</b>	<b>V</b>	<b>690</b>	<b>1000</b>
Rated impulse voltage	kV	8	8
<b>UL / CUL (Use Group)</b>		<b>B</b>	<b>C</b>
<b>Rated voltage</b>	<b>V</b>	<b>300</b>	<b>300</b>
<b>Rated current</b>	<b>A</b>	<b>60</b>	<b>60</b>
<b>AWG conductor</b>	<b>AWG</b>	-	-
<b>CSA (Use Group)</b>		<b>B</b>	<b>C</b>
Rated voltage	V	300	300
Rated current	A	60	60
AWG conductor	AWG	-	-
<b>General data</b>			
Type of insulation material			
UL 94 flammability rating			
Contact base material			
Material of contact surface			
Pin dimensions = d	mm	1.2	1.1
Solder eyelet Ø = D			
Solder eyelet Ø tolerance	mm		

**Accessories**

**Note:** Refer to the Accessories chapter for additional accessories.

Coding	Order No.
KO BU/SU10.16HP / BV/SV7.62	1824410000
KO BU/SU10.16HP WT	2592600000



**Ordering data**

<b>Solder pin length</b>	3.5 mm			
<b>Colour</b>	Black			
<b>Pitch</b>	10.16 mm			
Pol.	L1	(inch)	Qty.	Order No.
2	10.16	0.400	60	2580350000
3	20.32	0.800	42	2580830000
4	30.48	1.200	36	2580860000
5	40.64	1.600	20	2597290000
6	50.80	2.000	20	2597300000

SU 10.16HP../270MF3



Dimensioned drawing

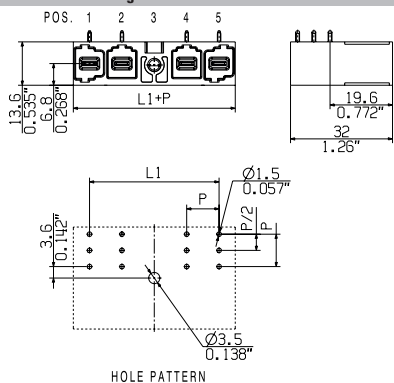

Ordering data

Solder pin length		3.5 mm		
Colour		Black		
Pitch		10.16 mm		
Pol.	L1	(inch)	Qty.	Order No.
3	20.32	0.800	42	2580850000
4	30.48	1.200	36	2580870000
5	40.64	1.600	20	2597310000
6	50.80	2.000	20	2597320000

SU 10.16HP../270MF4



Dimensioned drawing

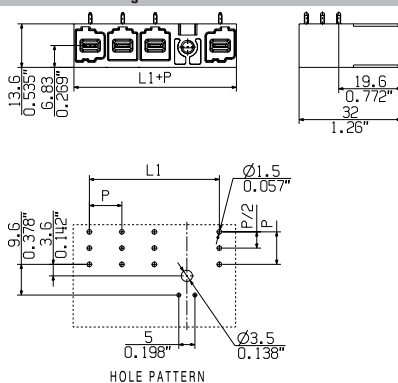

Ordering data

Solder pin length		3.5 mm		
Colour		Black		
Pitch		10.16 mm		
Pol.	L1	(inch)	Qty.	Order No.
4	30.48	1.200	36	2580880000
5	40.64	1.600	20	2597330000
6	50.80	2.000	20	2597340000

**Plug-in connector, pitch 10.16 mm**  
**BU/SU 10.16 series - connection up to 16 mm<sup>2</sup>**

**SUZ 10.16HP../180**



Male plug in 180° outlet direction with clamping yoke screw connection for TNC (S) systems. Meets the requirements of UL1059 for 600 V Use Group C. The mating profile ensures touch safety of more than 3 mm according to IEC 61800-5-1 when connected.

Maximum operational reliability with a derating up to 125°C, a mating profile that can only be plugged in correct and unique coding capability.

- Available with a flange (F) and screw flange on request.

**Product data**

IEC: 1000 V / 78 A / 0.2 - 16 mm<sup>2</sup>  
 UL: 600 V / 57 A / AWG 24 - 6



For additional articles and information, refer to [catalog.weidmueller.com](http://catalog.weidmueller.com)

**Note:**

- Additional colours on request
- Rated current related to rated cross-section & min. No. of poles.
- Wire end ferrule without plastic collar to DIN 46228/1
- Wire end ferrule with plastic collar to DIN 46228/4
- P on drawing = pitch
- Rated data refer only to the component itself. Clearance and creepage distances to other components are to be designed in accordance with the relevant application standards.

**SUZ 10.16HP../180G**



**Dimensioned drawing**

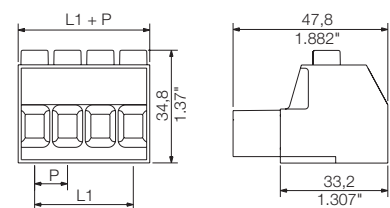

**Technical data**

In compliance with IEC 60664-1 / IEC 61984			
Clamping range, max.	mm <sup>2</sup>	0.2...16	
<b>Solid core H05(07) V-U</b>	<b>mm<sup>2</sup></b>	<b>0.2...16</b>	
Stranded H07 V-R		...16	
Flexible H05(07) V-K	mm <sup>2</sup>	0.5...16	
Flexible with ferrule	mm <sup>2</sup>	0.25...16	
Ferrule with plastic collar	mm <sup>2</sup>	0.25...10	
Stripping length	mm	12	
Screwdriver blade	mm	1.0 x 5.5	
According to norm		DIN 5264	
Tightening torque range	Nm	1.2...1.5	
<b>Rated current, max.</b>	<b>A</b>	<b>78</b>	<b>72</b>
At ambient temperature		20°C	40°C
For conductor cross-section	mm <sup>2</sup>	16	
Overvoltage category		III	III II
Pollution severity		3	2 2
<b>Rated voltage</b>	<b>V</b>	<b>1000</b>	<b>1000 1000</b>
Rated impulse voltage	kV	8	8 6
<b>UL / CUL (Use Group)</b>	<b>B C D</b>	<b>B</b>	<b>C D</b>
<b>Rated voltage</b>	<b>V</b>	<b>600</b>	<b>600 600</b>
<b>Rated current</b>	<b>A</b>	<b>57</b>	<b>57 5</b>
<b>AWG conductor</b>	<b>AWG</b>	<b>24-6</b>	
<b>CSA (Use Group)</b>	<b>B C D</b>	<b>B</b>	<b>C D</b>
Rated voltage	V	600	600 600
Rated current	A	57	57 5
AWG conductor	AWG	24-6	
General data			
Type of insulation material		PA GF	
UL 94 flammability rating		V-0	
Contact base material		Copper alloy	
Material of contact surface		silver-plated	
Pin dimensions = d	mm		
Solder eyelet Ø = D	mm		
Solder eyelet Ø tolerance	mm		

**Accessories**

**Note:** Refer to the Accessories chapter for additional accessories.

Coding	Order No.
KO BU/SU10.16HP / BV/SV7.62	<b>1824410000</b>
KO BU/SU10.16HP WT	<b>2592600000</b>
Screwdriver	
SDIS 1.0X5.5X125	<b>9008410000</b>
SDK PZ2	<b>9008540000</b>
Crosshead screwdriver	
SDIK PZ2	<b>9008890000</b>

**Ordering data**

Solder pin length				
Colour	Black			
Pitch	10.16 mm			
Pol.	L1	(inch)	Qty.	Order No.
2	10.16	0.400	64	<b>1947480000</b>
3	20.32	0.800	44	<b>1947490000</b>
4	30.48	1.200	32	<b>1947500000</b>
5	40.64	1.600	26	<b>1947510000</b>
6	50.80	2.000	22	<b>1966920000</b>
7	60.96	2.400	18	<b>1966930000</b>
8	71.12	2.800	16	<b>1962400000</b>
9	81.28	3.200	14	<b>1966910000</b>

**Representative deratings curve**

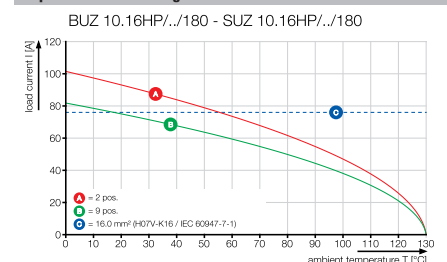



**Plug-in connector, pitch 10.16 mm**  
**BU/SU 10.16 series - connection up to 16 mm<sup>2</sup>**

**BUZ 10.16HP/./180**

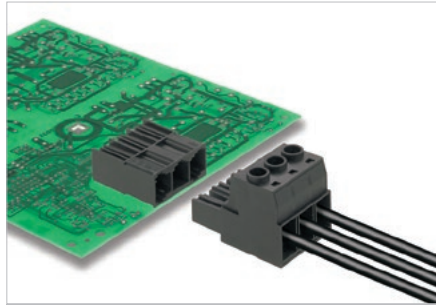

Female plug in 180° outlet direction with clamping yoke screw connection for TNC (S) systems. Meets the requirements of UL1059 for 600 V Use Group C. Ensures touch-safety of

> 3 mm in accordance with IEC 61800-5-1.

Maximum operational reliability with a derating up to 125°C, a mating profile that can only be plugged in correct and unique coding capability.

- Available with a flange (F) and screw flange (SF).

**Product data**

IEC: 1000 V / 78.3 A / 0.2 - 16 mm<sup>2</sup>  
 UL: 600 V / 60 A / AWG 22 - 4



For additional articles and information, refer to [catalog.weidmuller.com](http://catalog.weidmuller.com)

**Note:**

- Additional colours on request
- Rated current related to rated cross-section & min. No. of poles.
- Wire end ferrule with plastic collar to DIN 46228/4
- Wire end ferrule without plastic collar to DIN 46228/1
- P on drawing = pitch
- Rated data refer only to the component itself. Clearance and creepage distances to other components are to be designed in accordance with the relevant application standards.

**BUZ 10.16HP/./180**



**Dimensioned drawing**

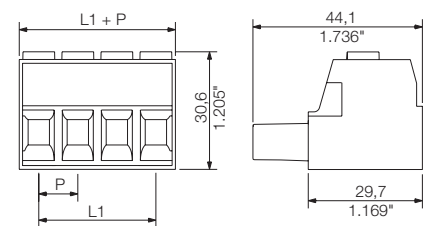

**Technical data**

**In compliance with IEC 60664-1 / IEC 61984**

Clamping range, max.	mm <sup>2</sup>	0.2...16
<b>Solid core H05(07) V-U</b>	<b>mm<sup>2</sup></b>	<b>0.2...16</b>
Stranded H07 V-R		...16
Flexible H05(07) V-K	mm <sup>2</sup>	0.5...16
Flexible with ferrule	mm <sup>2</sup>	0.25...16
Ferrule with plastic collar	mm <sup>2</sup>	0.25...16
Stripping length	mm	12
Screwdriver blade	mm	1.0 x 5.5
According to norm		DIN 5264
Tightening torque range	Nm	1.2...1.5
<b>Rated current, max.</b>	<b>A</b>	<b>78.3 70.6</b>
At ambient temperature		20°C 40°C
For conductor cross-section	mm <sup>2</sup>	16
Overvoltage category		III III II
Pollution severity		3 2 2
<b>Rated voltage</b>	<b>V</b>	<b>1000 1000 1000</b>
Rated impulse voltage	kV	8 8 6
<b>UL / CUL (Use Group)</b>	<b>B C D</b>	

<b>Rated voltage</b>	<b>V</b>	<b>600 600 600</b>
<b>Rated current</b>	<b>A</b>	<b>60 60 5</b>
<b>AWG conductor</b>	<b>AWG</b>	<b>22-4</b>
<b>CSA (Use Group)</b>	<b>B C D</b>	
Rated voltage	V	600 600 600
Rated current	A	60 60 5
AWG conductor	AWG	22-4

**General data**

Type of insulation material	PA GF
UL 94 flammability rating	V-0
Contact base material	Copper alloy
Material of contact surface	silver-plated
Pin dimensions = d	mm
Solder eyelet Ø = D	mm
Solder eyelet Ø tolerance	mm

**Accessories**

**Note:** Refer to the Accessories chapter for additional accessories.

Coding	Order No.
KO BU/SU10.16HP / BV/SV7.62	<b>1824410000</b>
KO BU/SU10.16HP WT	<b>2592600000</b>
Screwdriver	
SDIS 1.0X5.5X125	<b>9008410000</b>
SDK PZ2	<b>9008540000</b>
Crosshead screwdriver	
SDIK PZ2	<b>9008890000</b>

**Ordering data**

Solder pin length				
Colour	Black			
Pitch	10.16 mm			
Pol.	L1	(inch)	Qty.	Order No.
2	10.16	0.400	60	<b>1924540000</b>
3	20.32	0.800	40	<b>1924550000</b>
4	30.48	1.200	28	<b>1924560000</b>
5	40.64	1.600	24	<b>1924570000</b>
6	50.80	2.000	20	<b>1924580000</b>
7	60.96	2.400	16	<b>1924590000</b>
8	71.12	2.800	12	<b>1924600000</b>
9	81.28	3.200	12	<b>1924610000</b>

**Representative deratings curve**

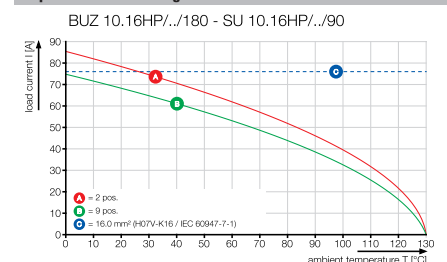

BUZ 10.16HP../180F



Dimensioned drawing

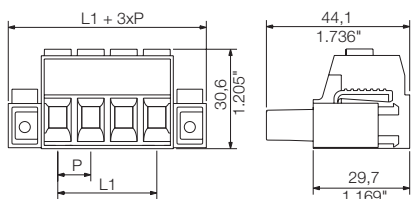

BUZ 10.16HP../180SF



Dimensioned drawing

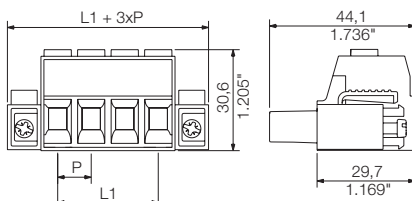

Ordering data

Solder pin length					
Colour					Black
Pitch 10.16 mm					
Pol.	L1	(inch)	Qty.	Order No.	
2	10.16	0.400	28	1924620000	
3	20.32	0.800	24	1924630000	
4	30.48	1.200	20	1924640000	
5	40.64	1.600	16	1924650000	
6	50.80	2.000	12	1924660000	
7	60.96	2.400	12	1924670000	
8	71.12	2.800	12	1924680000	
9	81.28	3.200	8	1924690000	

Ordering data

Solder pin length					
Colour					Black
Pitch 10.16 mm					
Pol.	L1	(inch)	Qty.	Order No.	
2	10.16	0.400	28	1924700000	
3	20.32	0.800	24	1924710000	
4	30.48	1.200	20	1924720000	
5	40.64	1.600	16	1924740000	
6	50.80	2.000	12	1924750000	
7	60.96	2.400	12	1924760000	
8	71.12	2.800	12	1924770000	
9	81.28	3.200	8	1924780000	



Additional deratings curves

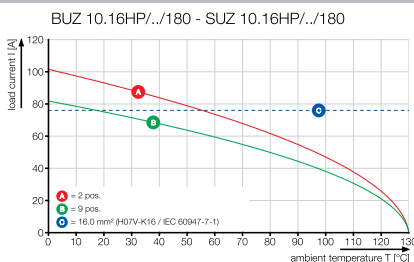
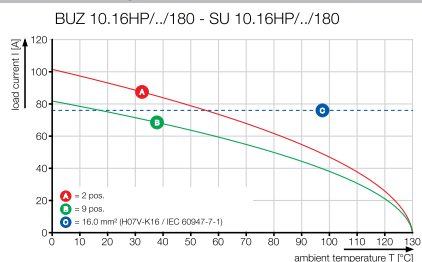

**Plug-in connector, pitch 10.16 mm**  
**BU/SU 10.16 series - connection up to 16 mm<sup>2</sup>**

**BUF 10.16IT../180**

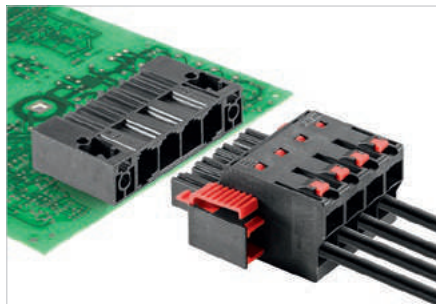

Female plug in 180° outlet direction with clamping yoke screw connection for TNC (S) systems. Meets the requirements of UL1059 for 600 V Use Group C. Ensures touch-safety of > 3 mm in accordance with IEC 61800-5-1. Maximum operational reliability with a derating up to 125°C, a mating profile that can only be plugged in correct and unique coding capability.

- Available with a flange (F) and screw flange (SF).

**Technical data**

In compliance with IEC 60664-1 / IEC 61984			
Clamping range, max.	mm <sup>2</sup>	2.5...16	
<b>Solid core H05(07) V-U</b>	<b>mm<sup>2</sup></b>	<b>2.5...10</b>	
Stranded H07 V-R		...16	
Flexible H05(07) V-K	mm <sup>2</sup>	2.5...16	
Flexible with ferrule	mm <sup>2</sup>	2.5...16	
Ferrule with plastic collar	mm <sup>2</sup>	2.5...16	
Stripping length	mm	18	
Screwdriver blade	mm	0.8 x 4.0	
According to norm		DIN 5264	
Tightening torque range			
<b>Rated current, max.</b>	<b>A</b>	<b>76</b>	<b>70</b>
At ambient temperature		20°C	40°C
For conductor cross-section	mm <sup>2</sup>	16	
Overvoltage category		III	III II
Pollution severity		3	2 2
<b>Rated voltage</b>	<b>V</b>	<b>1000</b>	<b>1000 1000</b>
Rated impulse voltage	kV	8	8 8
<b>UL / CUL (Use Group)</b>		<b>B</b>	<b>C D</b>
<b>Rated voltage</b>	<b>V</b>	<b>600</b>	<b>600</b>
<b>Rated current</b>	<b>A</b>	<b>55</b>	<b>55</b>
<b>AWG conductor</b>	<b>AWG</b>	<b>12-4</b>	
<b>CSA (Use Group)</b>		<b>B</b>	<b>C D</b>
Rated voltage	V		
Rated current	A		
AWG conductor	AWG		
General data			
Type of insulation material		PA GF	
UL 94 flammability rating		V-0	
Contact base material		Copper alloy	
Material of contact surface		silver-plated	
Pin dimensions = d	mm		
Solder eyelet Ø = D			
Solder eyelet Ø tolerance	mm		

**Product data**

IEC: 1000 V / 76 A / 2.5 - 16 mm<sup>2</sup>  
 UL: 600 V / 55 A / AWG 12 - 4



For additional articles and information, refer to [catalog.weidmuller.com](http://catalog.weidmuller.com)

**Note:**

- Additional colours on request
- Rated current related to rated cross-section & min. No. of poles.
- Wire end ferrule with plastic collar to DIN 46228/4
- Wire end ferrule without plastic collar to DIN 46228/1
- P on drawing = pitch
- Rated data refer only to the component itself. Clearance and creepage distances to other components are to be designed in accordance with the relevant application standards.

**BUF 10.16IT../180**



**Dimensioned drawing**

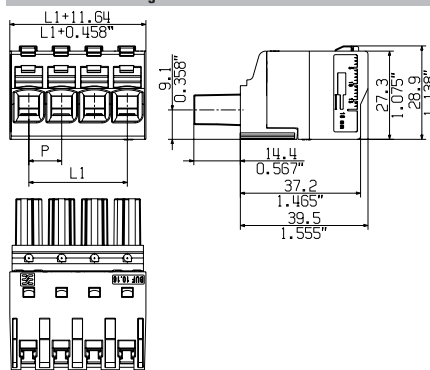

**Accessories**

**Note:** Refer to the Accessories chapter for additional accessories.

Coding	Order No.
KO BU/SU10.16HP / BV/SV7.62	<b>1824410000</b>
KO BU/SU10.16HP WT	<b>2592600000</b>
Screwdriver	
SDS 0.8X4.5X125	<b>9009020000</b>

**Ordering data**

Solder pin length				
Colour	Black			
Pitch	10.16 mm			
Pol.	L1	(inch)	Qty.	Order No.
2	10.16	0.400	56	<b>2493170000</b>
3	20.32	0.800	36	<b>2493400000</b>
4	30.48	1.200	28	<b>2493410000</b>
5	40.64	1.600	24	<b>2493420000</b>
6	50.80	2.000	20	<b>2586520000</b>
7	60.96	2.400	20	<b>2586550000</b>
8	71.12	2.800	20	<b>2586560000</b>
9	81.28	3.200	20	<b>2586570000</b>

**Representative deratings curve**

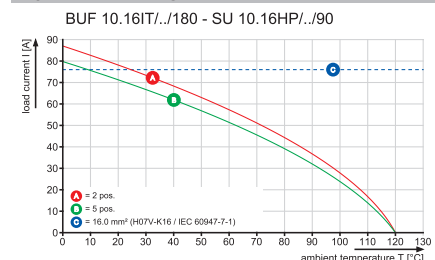



BUF 10.16IT../180F



Dimensioned drawing

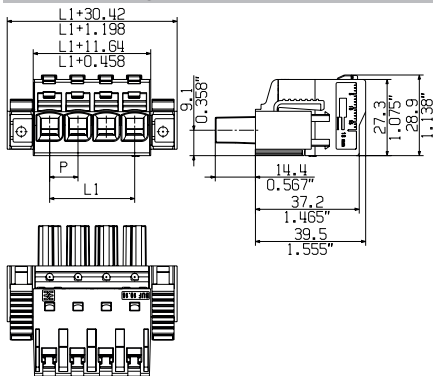

Ordering data

Solder pin length					
Colour					Black
Pitch 10.16 mm					
Pol.	L1	(inch)	Qty.	Order No.	
2	10.16	0.400	28	2493300000	
3	20.32	0.800	24	2493310000	
4	30.48	1.200	20	2493320000	
5	40.64	1.600	16	2493330000	
6	50.80	2.000	16	2586530000	
7	60.96	2.400	20	2586580000	
8	71.12	2.800	20	2586650000	
9	81.28	3.200	20	2586600000	

BUF 10.16IT../180SF



Dimensioned drawing

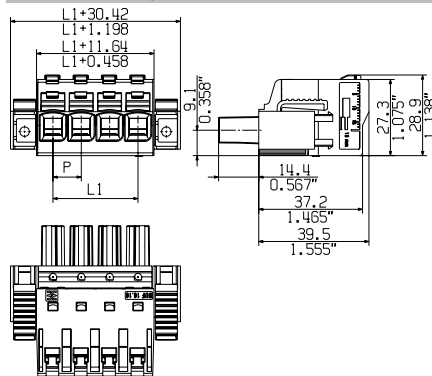

Ordering data

Solder pin length					
Colour					Black
Pitch 10.16 mm					
Pol.	L1	(inch)	Qty.	Order No.	
2	10.16	0.400	28	2493340000	
3	20.32	0.800	24	2493350000	
4	30.48	1.200	20	2493360000	
5	40.64	1.600	16	2493370000	
6	50.80	2.000	20	2586610000	
7	60.96	2.400	20	2586620000	
8	71.12	2.800	20	2586630000	
9	81.28	3.200	20	2586640000	

Additional deratings curves

BUF 10.16IT../180 - SU 10.16HP../90

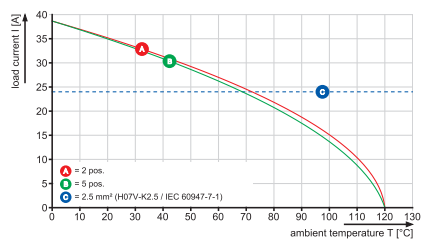

**Plug-in connector, pitch 10.16 mm**  
**BU/SU 10.16 series - connection up to 16 mm<sup>2</sup>**

**BUL 10.16HP../180**

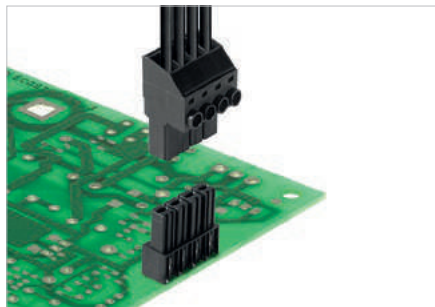

Finger-safe female header with 180° outlet direction for PCBs. Meets the requirements of IEC 61800-5-1 and allows UL approval in accordance with UL508 / UL840 for 600 V. An ideal finger-safe solution for power output and DC-link applications. The pin arrangement is finger-safe. The assembly coding ensures that it cannot be assembled on the PCB turned through 180°.

**Features:**

- Derating up to 130°C, 100%
- Pin arrangement that prevents wrong connections or wrong wiring
- Unique coding diversity and assembly coding

**Technical data**

**In compliance with IEC 60664-1 / IEC 61984**

Clamping range, max.			
<b>Solid core H05(07) V-U</b>			
Stranded H07 V-R			
Flexible H05(07) V-K			
Flexible with ferrule			
Ferrule with plastic collar			
Stripping length			
Screwdriver blade	mm		
According to norm			
Tightening torque range			
<b>Rated current, max.</b>	<b>A</b>	<b>76</b>	<b>69</b>
At ambient temperature		20°C	40°C
For conductor cross-section			
Overvoltage category		III	III
Pollution severity		3	2
<b>Rated voltage</b>	<b>V</b>	<b>630</b>	<b>630</b>
Rated impulse voltage	kV	6	6
<b>UL / CUL (Use Group)</b>	<b>B</b>	<b>C</b>	<b>D</b>
<b>Rated voltage</b>	<b>V</b>	<b>300</b>	<b>300</b>
<b>Rated current</b>	<b>A</b>	<b>57</b>	<b>57</b>
<b>AWG conductor</b>	<b>AWG</b>	-	-
<b>CSA (Use Group)</b>	<b>B</b>	<b>C</b>	<b>D</b>
Rated voltage	V	300	300
Rated current	A	57	57
AWG conductor	AWG	-	-
<b>General data</b>			
Type of insulation material		PA GF	
UL 94 flammability rating		V-0	
Contact base material		Copper alloy	
Material of contact surface		silver-plated	
Pin dimensions = d	mm	0.8 x 1.0	
Solder eyelet Ø = D	mm	1.3	
Solder eyelet Ø tolerance	mm	+ 0,1	

**Product data**

IEC: 1000 V / 76 A  
 UL: 300 V / 57 A



For additional articles and information, refer to [catalog.weidmueller.com](http://catalog.weidmueller.com)

**Note:**

- Additional colours on request
- Rated current related to rated cross-section & min. No. of poles.
- P on drawing = pitch
- Rated data refer only to the component itself. Clearance and creepage distances to other components are to be designed in accordance with the relevant application standards.

**BUL 10.16HP../180**

**Without flange**



**Dimensioned drawing**

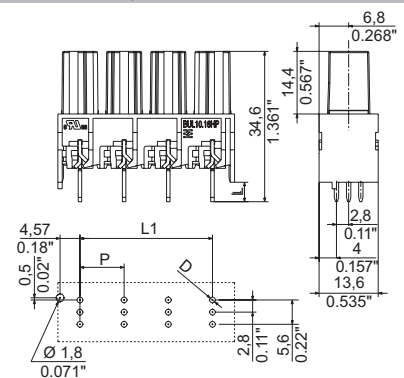

**Ordering data**

<b>Solder pin length</b>	4.5 mm		
<b>Colour</b>	Black		
<b>Pitch</b>	10.16 mm		
<b>Pol.</b>	<b>L1</b>	<b>(inch)</b>	<b>Qty.</b>
2	10.16	0.400	50
3	10.16	0.400	50
4	10.16	0.400	50
			<b>Order No.</b>
			1289000000
			1341270000
			1289010000

**Accessories**

**Note:** Refer to the Accessories chapter for additional accessories.

<b>Coding</b>	<b>Order No.</b>
KO BU/SU10.16HP / BV/SV7.62	1824410000
KO BU/SU10.16HP WT	2592600000

**Representative deratings curve**

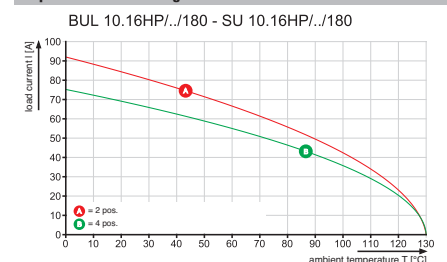

# OMNIMATE® Power Through-Panel Terminals

## OMNIMATE® Power Through-Panel Terminals

Through-Panel Terminals for devices  
Series PGK 4 and WGK

Explanation	L.2
System overview	L.6
Quick selection	L.8

Through-Panel Terminals for devices  
Series PGK 4 – PUSH IN connection

Product selection	
- Max. clamping range 4 mm <sup>2</sup>	L.10

Through-Panel Terminals for devices  
Series WGK – connects up to 95 mm<sup>2</sup>

Product selection	
- Max. clamping range 6 mm <sup>2</sup>	L.12
- Max. clamping range 10 mm <sup>2</sup>	L.14
- Max. clamping range 16 mm <sup>2</sup>	L.16
- Max. clamping range 25 mm <sup>2</sup>	L.18
- Max. clamping range 35 mm <sup>2</sup>	L.20
- Max. clamping range 50 mm <sup>2</sup>	L.22
- Max. clamping range 95 mm <sup>2</sup>	L.24

# OMNIMATE® – PUSH IN PGK 4 through-panel terminal

## Comfortable, cost-saving installation and connection of conductors up to 4 mm<sup>2</sup>

**In your applications space is limited. Save space and time for your housing feedthrough with our flexible connection system. Let's connect.**

You are looking for a space-saving solution to quickly install wire connections for your device with panel or housing feed-throughs.

You'll find what you are looking for with our innovative PUSH IN connectivity technology solutions. Our PGK 4 feed-through terminal is worthy of note for its tool-free wire connection on the interior and exterior of your device. Thanks to its flexible, sliced construction and the intuitive fastening mechanism, it's easy for you to build blocks with plenty of poles.

With such features, our PGK 4 is currently the most compact and fastest solution for housing feedthroughs. Let's connect.

### Flexible application options

Due to its construction with only 5.1 mm wide slices, you can build simple, space-saving terminal blocks with plenty of poles.

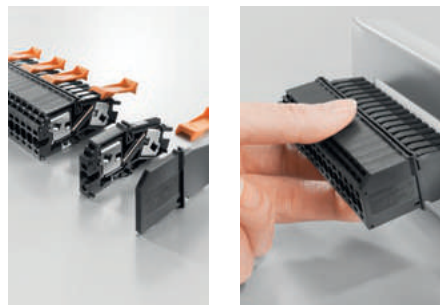

### Clear marking

The terminals can be clearly labelled on the top and bottom, so that the terminal block can always be marked regardless of mounting position.

### Simple handling and reduced assembly costs

Enjoy the benefits of the intuitive fastening mechanism and the ability to fasten the terminal block in the housing cut-out in seconds.



**Secure attachment through thick and thin**

The innovative terminal block fixing mechanism ensures a safe and reliable hold for the device feedthrough and is suited to panel thicknesses between 1.50 mm and 3.00 mm.



**Solid contact with a large connection cross-section**

Our innovative PUSH IN connection technology allows users to quickly and conveniently connect conductors. It also meets the need for permanent and vibration-resistant contacts. Conductor connections with a cross-section of up to 4.0 mm<sup>2</sup> with ferrules are possible.

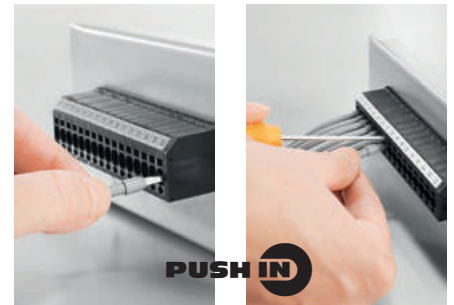

**Available for testing at any time**

You can perform a simple function check at any time using the easily accessible diagnostic test points.

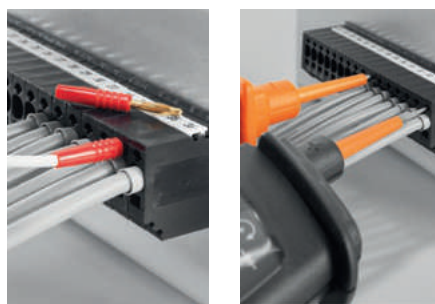

**Future-proofed materials and approvals**

Halogen-free materials and additional international approvals increase the application options for new device designs.

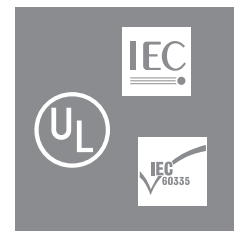

**Direct connected**

PUSH IN the quick, tool-free, intuitive connection mechanism for prepared wires. [www.push-in.com](http://www.push-in.com)

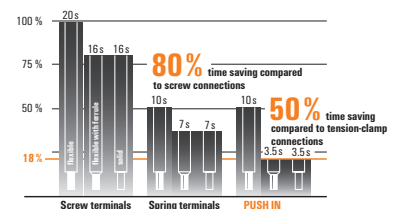

## Through-Panel Terminals WGK – OMNIMATE® Power

The universal solution to feed power through housing walls. Suitable for applications such as EMC filters, discretely structured converters for drive engineering, encapsulated equipment or inverters in the production of renewable energy.

Choose from the flexible range:

- Wide performance spectrum for currents up to 232 A and wire cross sections from 4 to 95 mm<sup>2</sup> (AWG 4/0)
- Various types of connections: castable solder connection, cable-lug-stud connection, and maintenance-free clamping-yoke screw connection
- Shapes for accommodating horizontal or vertical wire outlets

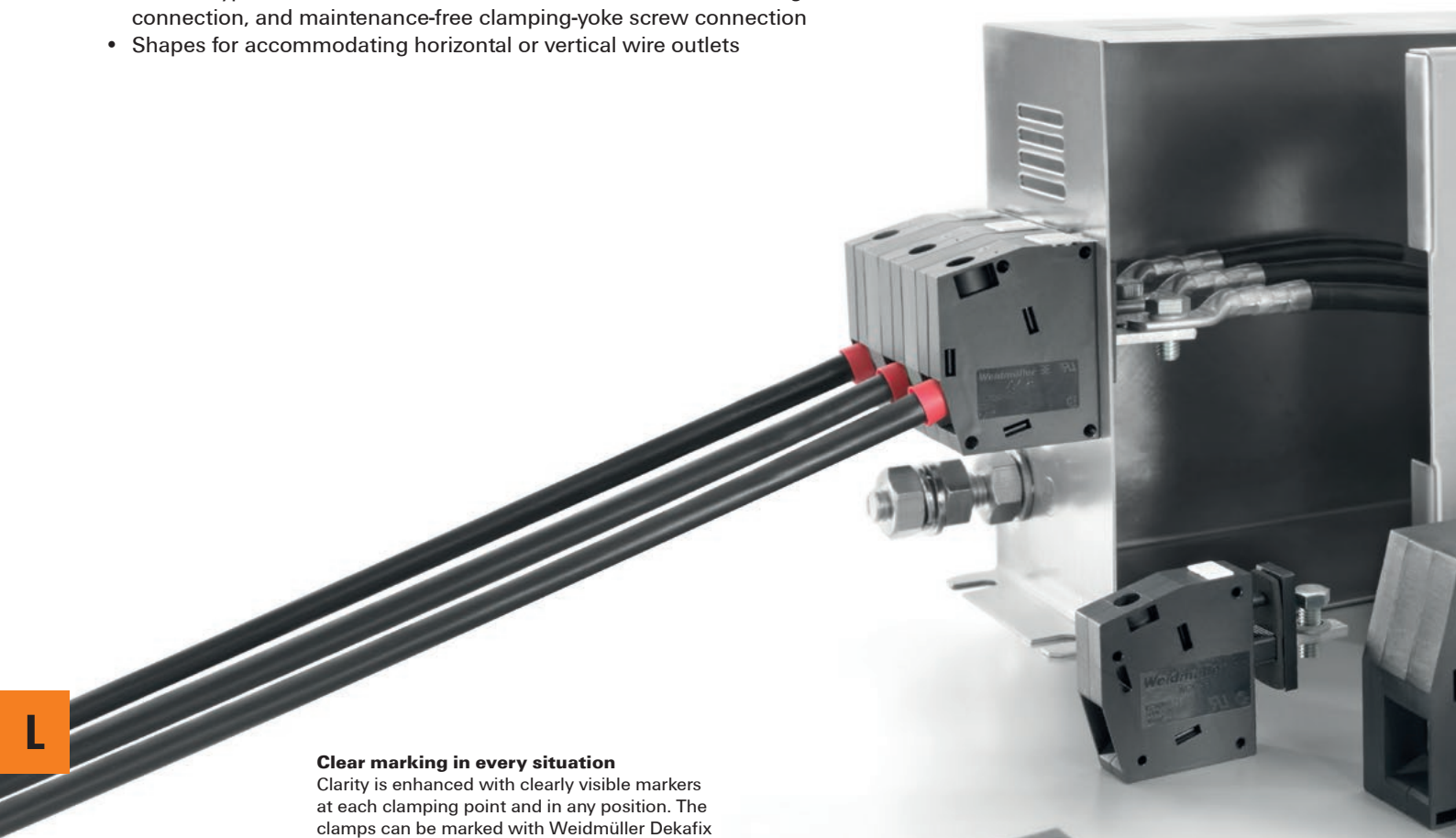

### Clear marking in every situation

Clarity is enhanced with clearly visible markers at each clamping point and in any position. The clamps can be marked with Weidmüller Dekafix markers and flexible paster tabs.



**Safety with extra power**

The high-performance insulating material WEMID meets maximum system availability requirements: With an RTI (relative temperature index) of 120 °C, the OMNIMATE® power Through-Panel Terminals exceed the highest continued use temperature of standard PA (100 °C) at +20° K, thus creating more power reserves and maximum safety with temperature fluctuations and overloads



**Easy handling**

WGK series lead-through terminals consist of an inside and outside component that are easily locked with one another through the housing wall without any tools.

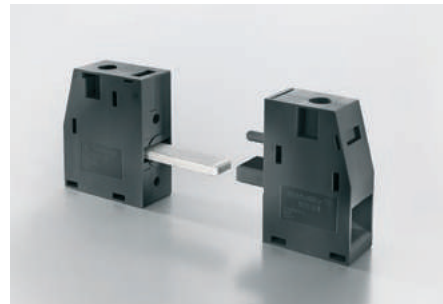



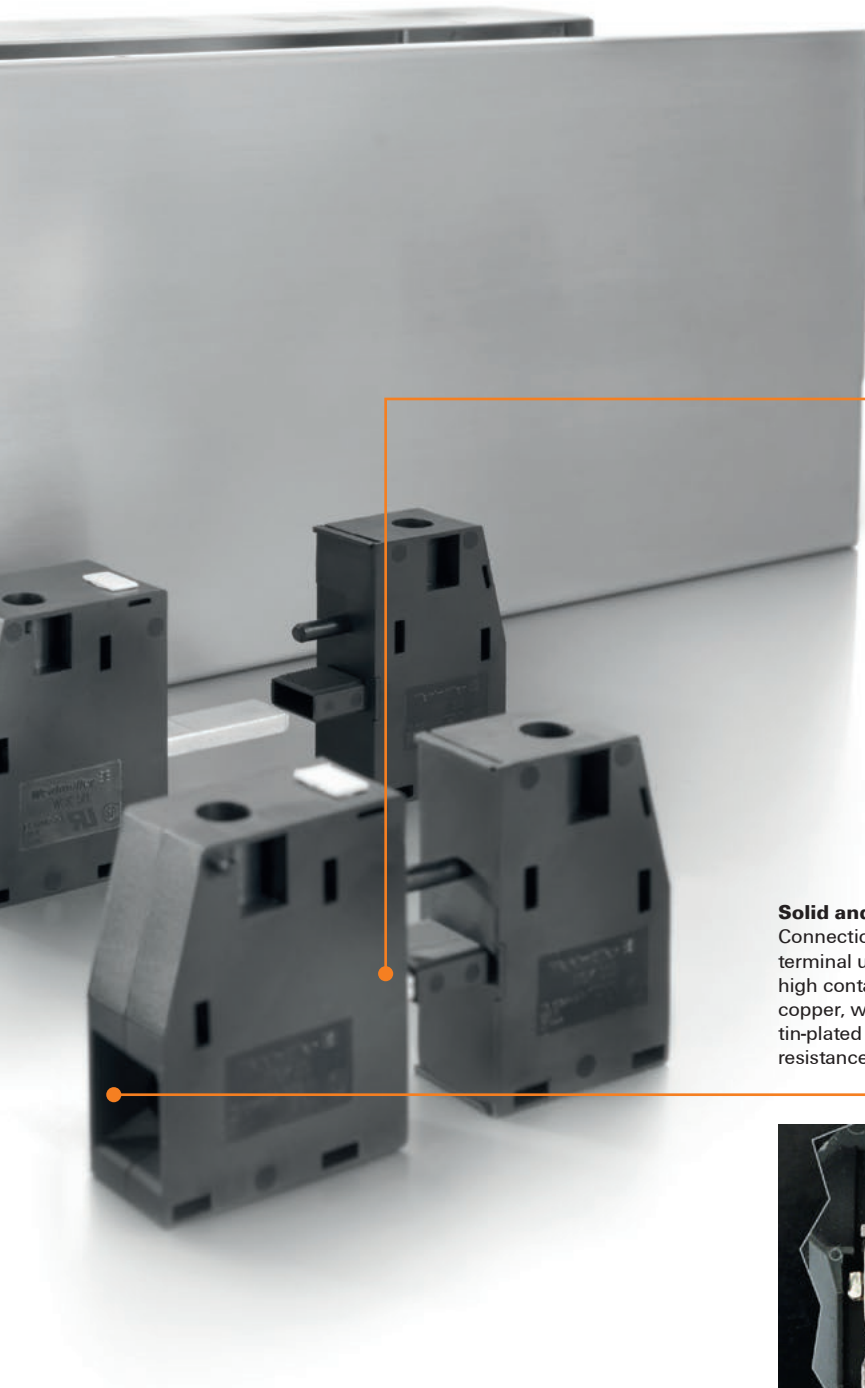
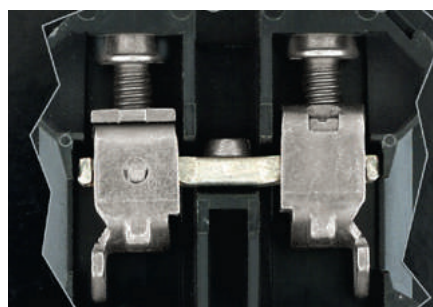

**Solid and proven connection**

Connections proven a million times. The terminal unit consists of hardened steel, for very high contact force. The current bar is made of copper, which gives a low voltage drop. The tin-plated surface ensures minimum contact resistances.

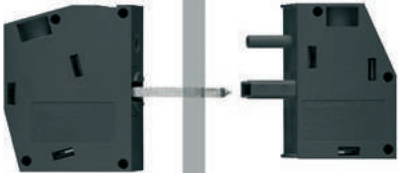

## WGK series – System overview

<p><b>WGK</b></p> 	<p><b>Easy installation</b></p> <p>WGK series feedthrough terminals consist of an inside and outside component that are easily locked with one another through the housing wall without any tools.</p>
	

<p><b>VWGK</b></p> 	<p><b>Maximum freedom of design</b></p> <p>Different types of connection on the inside such as a castable soldering connection (VWGK...), cable lug bolt connection (WGK ...VP) and a no-service clamping yoke-screw connection (WGK...) provide the optimum connection in any installation situation.</p>
<p><b>WGK...VP</b></p> 	
<p><b>WGK...WGKV</b></p> 	<p>Weidmüller offers two models with a horizontal (WGK) and vertical (WGKV) outgoing direction to adapt the conductor guide to the given installation conditions.</p>

L



The VP and VWGK models of the WGK lead-through terminals with an insulating housing and clamping yoke connection on the outside are enhanced for use in encapsulated and cast equipment (such as EMV filters).

These products are developed for 100 % sealing in completely cast units.

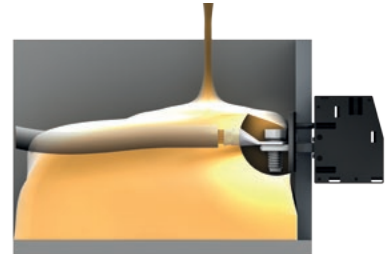

All Through-Panel Terminals terminals are available with pins (WGK.../Z) for easy locking. Multi-pole blocks can be built up quickly and easily.

Clearance and creepage distances to other components must be devised in accordance with the relevant application standard. This can be achieved in the device by full encapsulation or by the use of additional spacer plates.

Distance plates (DP WGK...) can be easily mounted with locking pins.

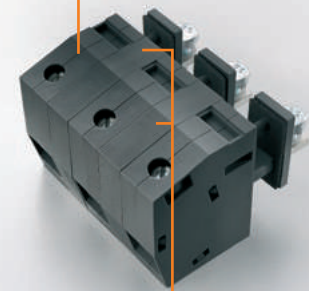
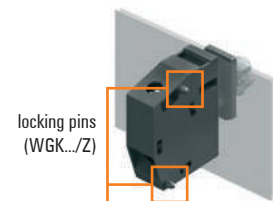

Fast and easy design in online CAD models. The CAD models for OMNIMATE® Power WGK lead-through terminals can be found in Weidmüller's online catalogue and in the PART community.

<http://catalog.weidmueller.com/>

<http://weidmueller.partcommunity.com/>

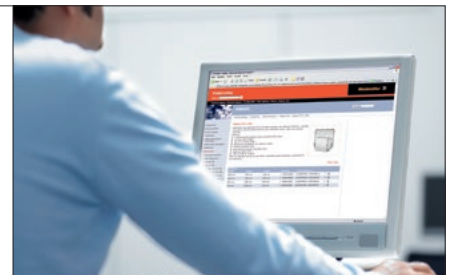

<http://www.OMNIMATE.net>

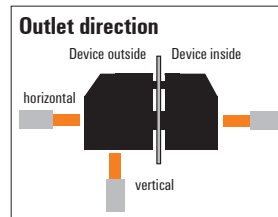

### Through-Panel terminals - WGK

Device Outside	Device Inside	Clamping range IEC Clamping range UL	Max. rated voltage IEC Nominal current UL		Type	Outlet direction	
Type of connection	Type of connection						
 <b>PUSH IN</b>	 <b>PUSH IN</b>	0.5 - 4 mm <sup>2</sup> 24 - 10 AWG	32 A 30 A		PGK 4	horizontal	
 <b>Screw Clamping yoke</b>	 <b>Solder connection</b>	0.5 - 6 mm <sup>2</sup> 30 - 10 AWG	32 A 30 A		VWGK 4	horizontal	
		0.5 - 10 mm <sup>2</sup> 22 - 8 AWG	41 A 50 A		VWGK 6	horizontal	
	 <b>Screw Clamping yoke</b>	0.5 - 6 mm <sup>2</sup> 30 - 10 AWG	32 A 30 A		WGK 4 WGKV 4	horizontal vertical	
		0.5 - 16 mm <sup>2</sup> 24 - 6 AWG	57 A 65 A		WGK 10 WGKV 10	horizontal vertical	
	 <b>Screw Clamping yoke</b>	 <b>Cable lug</b>	0.5 - 25 mm <sup>2</sup> 20 - 4 AWG	76 A 85 A		WGK 16 WGKV 16	horizontal vertical
						WGK 16 VP	horizontal
	 <b>Screw Clamping yoke</b>	 <b>Cable lug</b>	6 - 35 mm <sup>2</sup> 10 - 3 AWG	101 A 100 A		WGK 25 WGKV 25	horizontal vertical
						WGK 25 VP	horizontal
	 <b>Screw Clamping yoke</b>	 <b>Cable lug</b>	16 - 50 mm <sup>2</sup> 6 - 1/0 AWG	150 A 145 A		WGK 50	horizontal
						WGK 50 VP	horizontal
	 <b>Screw Clamping yoke</b>	 <b>Cable lug</b>	35 - 95 mm <sup>2</sup> 4 - 4/0 AWG	232 A 230 A		WGK 95	horizontal
						WGK 95 F VP	horizontal

Max. rated voltage IEC	400 V	500 V	690 V	1,000 V
	300 V		600 V	
Nominal voltage UL				
		○		
		○		
		○		
	○			
		○		
			○	
			○	
			○	
			○	
				○
				○

**Feed-through terminals for devices  
PGK series – PUSH IN connection**

max. clamping range: 4 mm<sup>2</sup>



The PGK 4 device feed-through terminal is the fastest and most compact solution for feed-throughs in housings.

The innovative "PUSH IN" connection system from Weidmüller makes for a simple, tool-free wire connection on the inside and outside of devices. The sliced design and an intuitive fastening mechanism enable high-density blocks to be constructed quickly and easily.

**Product data**

IEC: 500 V / 32 A / 0.5 - 4 mm<sup>2</sup>  
UL: 300 V / 30 A / AWG 24 - 10



For additional articles and information, refer to [catalog.weidmueller.com](http://catalog.weidmueller.com)

**Note:**

- Packing unit incl. 30 locking elements (VREL PGK 4 OR - 1288610000)
- End plate required
- Clearance and creepage distances to other components must be devised in accordance with the relevant application standard. This can be achieved in the device by full encapsulation or by the use of additional spacer plates.
- Rated data refer only to the component itself. Clearance and creepage distances to other components are to be designed in accordance with the relevant application standards.
- Colours: SW = black; GN/YL = green/yellow; GY = grey
- Additional colours on request

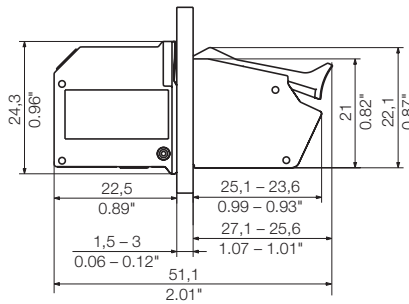

**Technical data**

In compliance with IEC 60664-1 / IEC 61984			
Clamping range, max.	mm <sup>2</sup>	0.5...4	
<b>Solid core H05(07) V-U</b>	<b>mm<sup>2</sup></b>	<b>0.5...4</b>	
Stranded H07 V-R			
Flexible H05(07) V-K	mm <sup>2</sup>	0.5...4	
Flexible with ferrule	mm <sup>2</sup>	0.5...4	
Ferrule with plastic collar	mm <sup>2</sup>	0.5...2.5	
Stripping length	mm	12	
Screwdriver blade	mm	0.4 x 2.5	
According to norm			
Tightening torque range			
<b>Rated current, max.</b>	<b>A</b>	<b>32</b>	
At ambient temperature		20°C	40°C
For conductor cross-section	mm <sup>2</sup>	4	
Overvoltage category		III	III II
Pollution severity		3	2 2
<b>Rated voltage</b>		<b>500</b>	
Rated impulse voltage		6	
<b>UL / CUL (Use Group)</b>		<b>B</b>	<b>C D</b>
<b>Rated voltage</b>	<b>V</b>	<b>300</b>	<b>150 300</b>
<b>Rated current</b>	<b>A</b>	<b>30</b>	<b>30 30</b>
<b>AWG conductor</b>	<b>AWG</b>	<b>24-10</b>	
<b>CSA (Use Group)</b>		<b>B</b>	<b>C D</b>
Rated voltage	V	300	150 300
Rated current	A	30	30 30
AWG conductor	AWG	24-10	
<b>General data</b>			
Type of insulation material		Wemid (PA)	
UL 94 flammability rating		V-0	
Contact base material		E-Cu	
Material of contact surface		tinned	
Pin dimensions = d	mm		
Solder eyelet Ø = D			
Solder eyelet Ø tolerance	mm		



**Accessories**

**Note:** Refer to the Accessories chapter for additional accessories.

Additional locking		Order No.
	VREL PGK4 OR VPE 30	1288610000
<b>Testing / Checking</b>		
	PS 2.3 RT	0180400000
<b>Screwdriver</b>		
	SDS 0.4X2.5X75	9009030000
	SDS 0.5X3.0X80	9008320000
<b>Pressing tool</b>		
	PZ 6/5	9011460000

**PGK 4**

**"PUSH IN" connection**



**Dimensioned drawing**

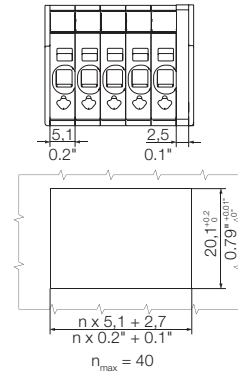

**Ordering data**

Type	Qty.	Order No.
PGK 4 BK	100	1288470000

**With lock pins**

**PGK 4 BT**

"PUSH IN" connection



Dimensioned drawing

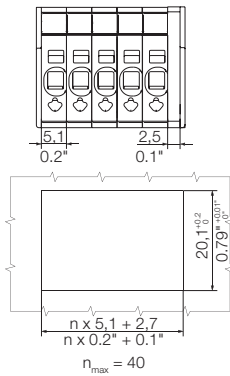

**Ordering data**

			With lock pins
Type	Qty.	Order No.	
PGK 4 BT BK	100	1288590000	

**EPL PGK 4**



Dimensioned drawing

**Ordering data**

			With lock pins
Type	Qty.	Order No.	
EPL PGK4 BK	50	1288600000	



## Feed-through terminals for devices WGK series – connection up to 95 mm<sup>2</sup>

max. clamping range: 6 mm<sup>2</sup>

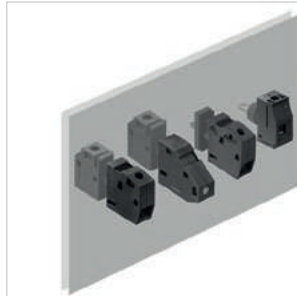

The high-current feed-through terminals of the WGK series provide a universal solution for feeding currents of different magnitude through the enclosure wall.

Various types of connection on the inside such as solder connections which can be encapsulated (VWGK...), cable lug connections (WGK ...VP) and maintenance-free clamping yoke screw connections (WGK...) with vertical and horizontal wire insertion provide the optimal connection for any installation situation.

The different peg types allow for a simple and quick assembly of multi-pole blocks.

### Product data

IEC: 500 V / 32 A / 0.5 - 6 mm<sup>2</sup>  
UL: 300 V / 30 A / AWG 30 - 10



For additional articles and information, refer to [catalog.weidmueller.com](http://catalog.weidmueller.com)

#### Note:

- Clearance and creepage distances to other components must be devised in accordance with the relevant application standard. This can be achieved in the device by full encapsulation or by the use of additional spacer plates.
- Rated data refer only to the component itself. Clearance and creepage distances to other components are to be designed in accordance with the relevant application standards.
- Colours: SW = black; GN/YL = green/yellow; GY = grey
- Additional colours on request
- WGK: Rated voltage plastic walls: 1 - 4 mm = 500 V; metal walls: 1 - 2.5 mm = 400 V; metal walls: 2.5 - 4 mm = 250 V
- WGKV: Rated voltage plastic walls: 1 - 4 mm = 400 V; metal walls: 1 - 2.5 mm = 400 V; metal walls: 2.5 - 4 mm = 250 V
- VWGK: Rated voltage plastic walls: 1 - 4 mm = 500 V; metal walls: 1 - 4 mm = 500 V

### WGK 4

#### Screw connection



#### Dimensioned drawing

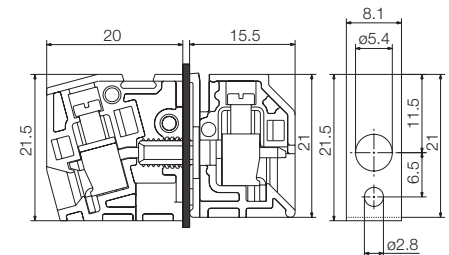

### Technical data

#### In compliance with IEC 60664-1 / IEC 61984

Clamping range, max.	mm <sup>2</sup>	0.5...6
<b>Solid core H05(07) V-U</b>	<b>mm<sup>2</sup></b>	<b>0.5...6</b>
Stranded H07 V-R		
Flexible H05(07) V-K	mm <sup>2</sup>	0.5...4
Flexible with ferrule	mm <sup>2</sup>	0.5...4
Ferrule with plastic collar		
Stripping length	mm	8
Screwdriver blade	mm	0.6 x 3.5
According to norm		
Tightening torque range	Nm	0.6...0.8
<b>Rated current, max.</b>	<b>A</b>	<b>32</b>
At ambient temperature	20°C	40°C
For conductor cross-section	mm <sup>2</sup>	4
Overtension category		III III II
Pollution severity		3 2 2
<b>Rated voltage</b>		<b>500</b>
Rated impulse voltage		6
<b>UL / CUL (Use Group)</b>	<b>B C D</b>	
<b>Rated voltage</b>	<b>V</b>	<b>300 300 300</b>
<b>Rated current</b>	<b>A</b>	<b>30 30 10</b>
<b>AWG conductor</b>	<b>AWG</b>	<b>30-10</b>
<b>CSA (Use Group)</b>	<b>B C D</b>	
Rated voltage	V	300 300 300
Rated current	A	30 30 10
AWG conductor	AWG	30-10
<b>General data</b>		
Type of insulation material		Wemid (PA)
UL 94 flammability rating		V-0
Contact base material		E-Cu
Material of contact surface		tinned
Pin dimensions = d	mm	
Solder eyelet Ø = D		
Solder eyelet Ø tolerance	mm	

### Accessories

Note: Refer to the Accessories chapter for additional accessories.

Distance plate	Order No.
DP WGK 4 BK BX	1297840000
DP WGK 4 GY BX	1936450000
DP WGKV 4	1936470000
DP VWGK 4 BK BX	1251030000
DP VWGK 4 GY BX	1936430000
Screwdriver	
SDIS 0.6X3.5X100	9008390000
Identification systems	
DEK 5/8 MC NE WS	1856740000
DEK 5/5 MC NE WS	1609801044
DEK 5/6 MC NE WS	1609820000

### Ordering data

Type	Qty.	Order No.	
		With lock pins	No lock pins
WGK 4/Z BK BX	50	1250940000	
WGK 4/Z GN/YE BX	50	1936560000	
WGK 4/Z GY BX	50	1936570000	
WGK 4 BK BX	50		1250930000
WGK 4 GN/YE BX	50		1936540000
WGK 4 GY BX	50		1936550000

### WGKV 4

Screw connection



Dimensioned drawing

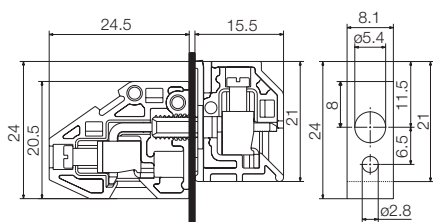

#### Ordering data

Type	Qty.	With lock pins		No lock pins	
		Order No.	Order No.	Order No.	Order No.
WGKV 4/Z BK BX	50	1250960000			
WGKV 4/Z GN/YE BX	50	1936620000			
WGKV 4/Z GY BX	50	1936630000			
WGKV 4 BK BX	50		1250950000		
WGKV 4 GN/YE BX	50		1936610000		
WGKV 4 GY BX	50		1934050000		

### WGK 4 VP

Solder connection



Dimensioned drawing

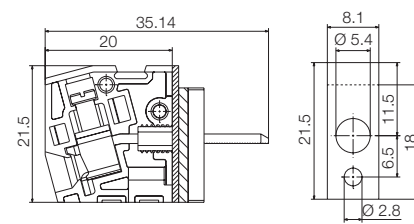

#### Ordering data

Type	Qty.	With lock pins		No lock pins	
		Order No.	Order No.	Order No.	Order No.
WGK 4 VP/Z BK BX	50	1339810000			
WGK 4 VP/Z GN/YE BX	50	1003900000			
WGK 4 VP/Z GY BX	50	1003910000			
WGK 4 VP BK BX	50		1339790000		
WGK 4 VP GN/YE BX	50		1003890000		
WGK 4 VP GY BX	50		1981890000		

For the rated voltage of plastic and metal walls, see the "WGK" notes

### VWVGK 4

Solder connection



Dimensioned drawing

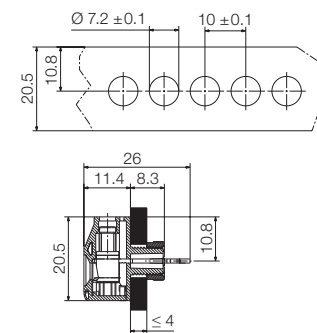

#### Ordering data

Type	Qty.	With lock pins	
		Order No.	Order No.
VWVGK 4 BK BX	50	1250650000	
VWVGK 4 GN/YE BX	50	1936480000	
VWVGK 4 GY BX	50	1936490000	

## Feed-through terminals for devices WGK series – connection up to 95 mm<sup>2</sup>

max. clamping range: 10 mm<sup>2</sup>

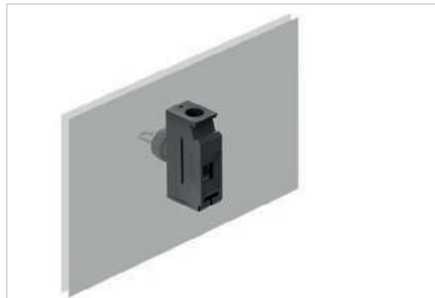

The V versions of the WGK feed-through terminals with an insulated housing and clamping yoke connection on the outside, and a solder connection on the inside. Optimal connection options for use in encapsulated devices (e.g. EMC filters and/or fully insulated transformers).

The different peg types allow for a simple and quick assembly of multi-pole blocks.

### Product data

IEC: 500 V / 41 A / 0.5 - 10 mm<sup>2</sup>  
UL: 300 V / 50 A / AWG 22 - 10



For additional articles and information, refer to [catalog.weidmueller.com](http://catalog.weidmueller.com)

#### Note:

- Clearance and creepage distances to other components must be devised in accordance with the relevant application standard. This can be achieved in the device by full encapsulation or by the use of additional spacer plates.
- Rated data refer only to the component itself. Clearance and creepage distances to other components are to be designed in accordance with the relevant application standards.
- Colours: SW = black; GN/YL = green/yellow; GY = grey
- Additional colours on request
- VWGK: Rated voltage plastic walls: 1 - 4 mm = 500 V; metal walls: 1 - 4 mm = 500 V

### VWGK 6



#### Dimensioned drawing

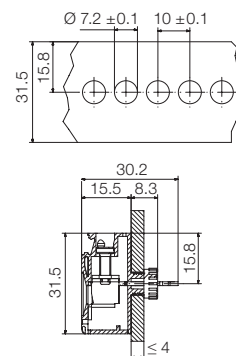

### Technical data

#### In compliance with IEC 60664-1 / IEC 61984

Clamping range, max.	mm <sup>2</sup>	0.5...10
<b>Solid core H05(07) V-U</b>	mm <sup>2</sup>	<b>0.5...10</b>
Stranded H07 V-R		...6
Flexible H05(07) V-K	mm <sup>2</sup>	0.5...6
Flexible with ferrule	mm <sup>2</sup>	0.5...6
Ferrule with plastic collar		
Stripping length	mm	13
Screwdriver blade	mm	0.8 x 4.0
According to norm		
Tightening torque range	Nm	0.8...1.8
<b>Rated current, max.</b>	<b>A</b>	<b>41</b>
At ambient temperature	20°C	40°C
For conductor cross-section	mm <sup>2</sup>	6
Overtension category		III III II
Pollution severity		3 2 2
<b>Rated voltage</b>		<b>500</b>
Rated impulse voltage		6

UL / CUL (Use Group)	B	C	D	
<b>Rated voltage</b>	<b>V</b>	<b>300</b>	<b>300</b>	<b>300</b>
<b>Rated current</b>	<b>A</b>	<b>50</b>	<b>50</b>	<b>10</b>
<b>AWG conductor</b>	<b>AWG</b>	<b>22-10</b>		
CSA (Use Group)	B	C	D	
Rated voltage	V	300	300	300
Rated current	A	50	50	10
AWG conductor	AWG	22-10		

#### General data

Type of insulation material	Wemid (PA)
UL 94 flammability rating	V-0
Contact base material	E-Cu
Material of contact surface	tinned
Pin dimensions = d	mm
Solder eyelet Ø = D	mm
Solder eyelet Ø tolerance	mm

### Accessories

Note: Refer to the Accessories chapter for additional accessories.

Distance plate	Order No.
DP VWGK 6 BK BX	<b>1250630000</b>
DP VWGK 6 GY BX	<b>1965750000</b>
Screwdriver	Order No.
SDIS 0.8X4.0X100	<b>9008400000</b>
Identification systems	Order No.
DEK 5/5 MC NE WS	<b>1609801044</b>
DEK 5/6 MC NE WS	<b>1609820000</b>
DEK 5/8 MC NE WS	<b>1856740000</b>

### Ordering data

Type	Qty.	Order No.
VWGK 6 BK BX	50	<b>2484810000</b>
VWGK 6 GN/YE BX	50	<b>2484680000</b>
VWGK 6 GY BX	50	<b>2484800000</b>

**No lock pins**



## Variants

The WGK...VP, VWGK 4 and VWGK 6 variants of the WGK series, with an insulating housing and clamping yoke connection on the outside, are specially enhanced for use in potted and through-panel applications.

These products are developed for 100 % sealing in completely enclosed units..

WGK variants are used, for example, as device connections for EMC filters or fully insulated transformers.

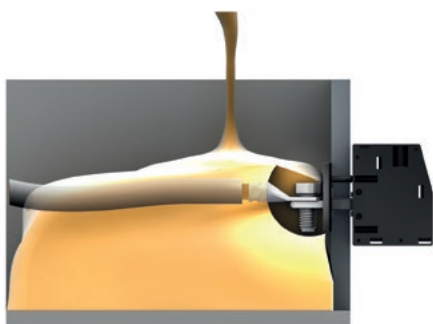

## Clamping yoke screw connection

The clamping yoke connection is a proven connection in use around the world today.

Steel clamping yokes made using a stamping and bending process guarantee a vibration proof clamp connection.

When the screw on the clamp is tightened, there is a counter effect in the clamping yoke's threaded area which prevents the connection accidentally loosening.

As the screw thread is on an inclined plane, the force is amplified and a very high clamping force is achieved.

Weidmüller uses hardened steel with optimised corrosion protection for stability and safety in addition to copper alloys in the contact area for good electrical conductivity.

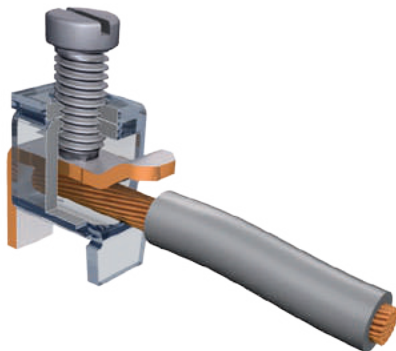

## Feed-through terminals for devices WGK series – connection up to 95 mm<sup>2</sup>

max. clamping range: 16 mm<sup>2</sup>

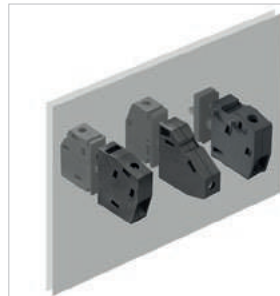

The high-current feed-through terminals of the WGK series provide a universal solution for feeding currents of different magnitude through the enclosure wall.

Different types of connection on the inside, such as a solder connection which can be encapsulated (WGK ...VP) or a maintenance-free clamping yoke screw connection (WGK...) with vertical and horizontal wire connections, provide the optimal connection for any installation situation.

The different peg types allow for a simple and quick assembly of multi-pole blocks.

### Product data

IEC: 500 V / 57 A / 0.5 - 16 mm<sup>2</sup>  
UL: 300 V / 65 A / AWG 24 - 6



For additional articles and information, refer to [catalog.weidmueller.com](http://catalog.weidmueller.com)

#### Note:

- Clearance and creepage distances to other components must be devised in accordance with the relevant application standard. This can be achieved in the device by full encapsulation or by the use of additional spacer plates.
- Rated data refer only to the component itself. Clearance and creepage distances to other components are to be designed in accordance with the relevant application standards.
- Colours: SW = black; GN/YL = green/yellow; GY = grey
- Additional colours on request
- WGK: Rated voltage plastic walls: 1 - 4 mm = 500 V; metal walls: 1 - 2.5 mm = 400 V; metal walls: 2.5 - 4 mm = 250 V

### WGK 10



#### Dimensioned drawing

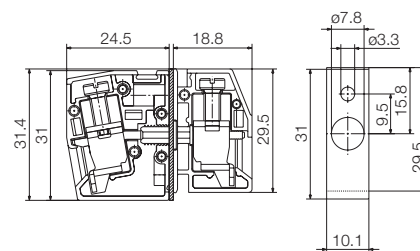

### Technical data

In compliance with IEC 60664-1 / IEC 61984			
Clamping range, max.	mm <sup>2</sup>	0.5...16	
<b>Solid core H05(07) V-U</b>	<b>mm<sup>2</sup></b>	<b>0.5...16</b>	
Stranded H07 V-R	mm <sup>2</sup>	10...16	
Flexible H05(07) V-K	mm <sup>2</sup>	0.5...10	
Flexible with ferrule	mm <sup>2</sup>	0.5...10	
Ferrule with plastic collar			
Stripping length	mm	11	
Screwdriver blade	mm	0.8 x 4.0	
According to norm			
Tightening torque range	Nm	1.2...2.4	
<b>Rated current, max.</b>	<b>A</b>	<b>57</b>	
At ambient temperature	20°C	40°C	
For conductor cross-section	mm <sup>2</sup>	10	
Overtoltage category		III III II	
Pollution severity		3 2 2	
<b>Rated voltage</b>		<b>500</b>	
Rated impulse voltage		6	
<b>UL / CUL (Use Group)</b>	<b>B C D</b>		
<b>Rated voltage</b>	<b>V</b>	<b>300 300</b>	
<b>Rated current</b>	<b>A</b>	<b>65 65</b>	
<b>AWG conductor</b>	<b>AWG</b>	<b>24-6</b>	
<b>CSA (Use Group)</b>	<b>B C D</b>		
Rated voltage	V	300 300	
Rated current	A	65 65	
AWG conductor	AWG	24-6	
<b>General data</b>			
Type of insulation material		Wemid (PA)	
UL 94 flammability rating		V-0	
Contact base material		E-Cu	
Material of contact surface		tinned	
Pin dimensions = d	mm		
Solder eyelet Ø = D			
Solder eyelet Ø tolerance	mm		

### Accessories

Note: Refer to the Accessories chapter for additional accessories.

Distance plate	Order No.
DP VWGK 6 BK BX	1250630000
DP VWGK 6 GY BX	1965750000
DP WGK 10 BK BX	
DP WGK 10 GY BX	
DP WGKV 10	
Screwdriver	
SDIS 0.8X4.0X100	9008400000
Identification systems	
DEK 5/5 MC NE WS	1609801044
DEK 5/6 MC NE WS	1609820000
DEK 5/8 MC NE WS	1856740000

### Ordering data

Type	Qty.	Order No.	
		With lock pins	No lock pins
WGK 10/Z BK BX	50	2439460000	
WGK 10/Z GN/YE BX	50	2439400000	
WGK 10/Z GY BX	50	2439410000	
WGK 10 BK BX	50		2439470000
WGK 10 GN/YE BX	50		2439380000
WGK 10 GY BX	50		2439390000

## WGKV 10



Dimensioned drawing

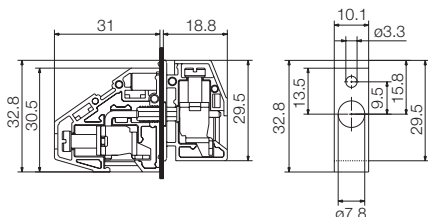

### Ordering data

Type	Qty.	With lock pins		No lock pins	
		Order No.	Order No.	Order No.	Order No.
WGKV 10/Z BK BX	50	2439580000			
WGKV 10/Z GN/YE BX	50	2439540000			
WGKV 10/Z GY BX	50	2439550000			
WGKV 10 BK BX	50		2439570000		
WGKV 10 GN/YE BX	50		2439530000		
WGKV 10 GY BX	50		2439520000		

For the rated voltage of plastic and metal walls, see the "WGK" notes

## WGK 10 VP



Dimensioned drawing

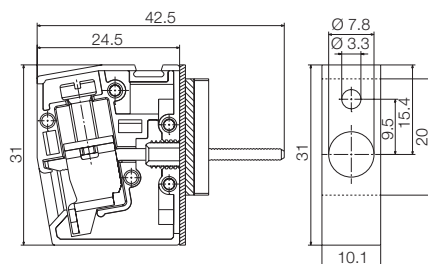

### Ordering data

Type	Qty.	With lock pins		No lock pins	
		Order No.	Order No.	Order No.	Order No.
WGK 10 VP/Z GN/YE BX	50	2439440000			
WGK 10 VP/Z GY BX	50	2439420000			
WGK 10 VP GN/YE BX	50		2439430000		
WGK 10 VP GY BX	50		2439450000		

For the rated voltage of plastic and metal walls, see the "WGK" notes

## Variants

The WGK...VP, VWGK 4 and VWGK 6 variants of the WGK series, with an insulating housing and clamping yoke connection on the outside, are specially enhanced for use in potted and through-panel applications. These products are developed for 100 % sealing in completely enclosed units..

WGK variants are used, for example, as device connections for EMC filters or fully insulated transformers.

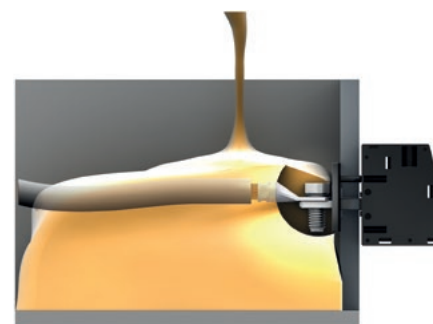

### Clamping yoke screw connection

The clamping yoke connection is a proven connection in use around the world today.

Steel clamping yokes made using a stamping and bending process guarantee a vibration proof clamp connection. When the screw on the clamp is tightened, there is a counter effect in the clamping yoke's threaded area which prevents the connection accidentally loosening.

As the screw thread is on an inclined plane, the force is amplified and a very high clamping force is achieved. Weidmüller uses hardened steel with optimised corrosion protection for stability and safety in addition to copper alloys in the contact area for good electrical conductivity.

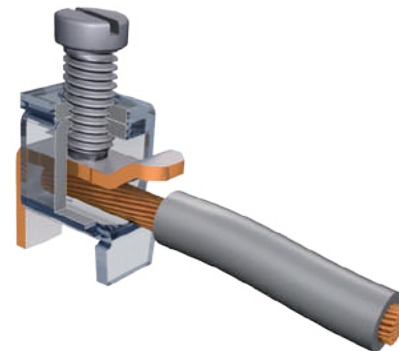

## Feed-through terminals for devices WGK series – connection up to 95 mm<sup>2</sup>

max. clamping range: 25 mm<sup>2</sup>



The high-current feed-through terminals of the WGK series provide a universal solution for feeding currents of different magnitude through the enclosure wall.

Various types of connection on the inside, such as cable lug connections which can be encapsulated (WGK ...VP) and maintenance-free clamping yoke screw connections (WGK...) with vertical and horizontal wire insertion provide the optimal connection for any installation situation.

The different peg types allow for a simple and quick assembly of multi-pole blocks.

### Product data

IEC: 500 V / 76 A / 0.5 - 25 mm<sup>2</sup>  
UL: 600 V / 85 A / AWG 20 - 4



For additional articles and information, refer to [catalog.weidmueller.com](http://catalog.weidmueller.com)

#### Note:

- Clearance and creepage distances to other components must be devised in accordance with the relevant application standard. This can be achieved in the device by full encapsulation or by the use of additional spacer plates.
- Rated data refer only to the component itself. Clearance and creepage distances to other components are to be designed in accordance with the relevant application standards.
- Colours: SW = black; GN/YL = green/yellow; GY = grey
- Additional colours on request
- WGK: Rated voltage plastic walls: 1 - 6 mm = 800 V; metal walls: 1 - 2.5 mm = 800 V; metal walls: 2.5 - 4 mm = 690 V; metal walls: 4 - 6 mm = 500 V

### WGK 16



#### Dimensioned drawing

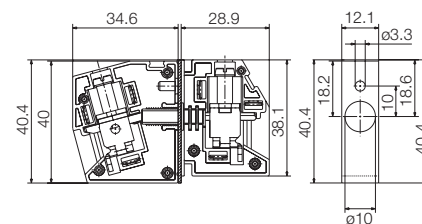

### Technical data

#### In compliance with IEC 60664-1 / IEC 61984

Clamping range, max.	mm <sup>2</sup>	0.5...25
<b>Solid core H05(07) V-U</b>	<b>mm<sup>2</sup></b>	<b>0.5...16</b>
Stranded H07 V-R	mm <sup>2</sup>	10...25
Flexible H05(07) V-K	mm <sup>2</sup>	0.5...16
Flexible with ferrule	mm <sup>2</sup>	0.5...16
Ferrule with plastic collar		
Stripping length	mm	16
Screwdriver blade	mm	1.0 x 5.5
According to norm		
Tightening torque range	Nm	2...2.3
<b>Rated current, max.</b>	<b>A</b>	<b>76</b>
At ambient temperature	20°C	40°C
For conductor cross-section	mm <sup>2</sup>	16
Overvoltage category		III III II
Pollution severity		3 2 2
<b>Rated voltage</b>		<b>500</b>
Rated impulse voltage		6

UL / CUL (Use Group)	B	C	D
<b>Rated voltage</b>	<b>V</b>	<b>600</b>	<b>600</b>
<b>Rated current</b>	<b>A</b>	<b>85</b>	<b>85</b>
<b>AWG conductor</b>	<b>AWG</b>	<b>20-4</b>	
CSA (Use Group)	B	C	D
Rated voltage	V	600	600
Rated current	A	85	85
AWG conductor	AWG	20-4	

#### General data

Type of insulation material	Wemid (PA)
UL 94 flammability rating	V-0
Contact base material	E-Cu
Material of contact surface	tinned
Pin dimensions = d	mm
Solder eyelet Ø = D	mm
Solder eyelet Ø tolerance	mm

### Accessories

Note: Refer to the Accessories chapter for additional accessories.

Distance plate	Order No.
DP WGK 16 BK BX	1250580000
DP WGK 16 GY BX	1936700000
Screwdriver	Order No.
SDIS 1.0X5.5X125	9008410000
Identification systems	Order No.
DEK 5/5 MC NE WS	1609801044
DEK 5/6 MC NE WS	1609820000
DEK 5/8 MC NE WS	1856740000

### Ordering data

Type	Qty.	Order No.	
		With lock pins	No lock pins
WGK 16/Z BK BX	50	2440600000	
WGK 16/Z GN/YE BX	50	2440570000	
WGK 16/Z GY BX	50	2440580000	
WGK 16 BK BX	50		2440590000
WGK 16 GN/YE BX	50		2439600000
WGK 16 GY BX	50		2440560000

WGKV 16



Dimensioned drawing

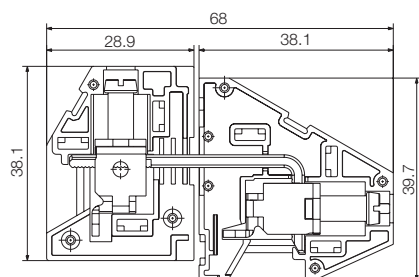

WGK 16 VP



Dimensioned drawing

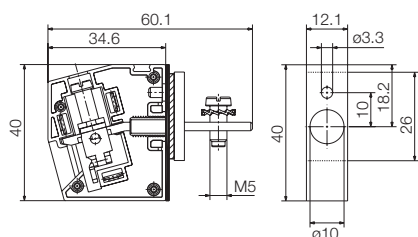

Ordering data

Type	Qty.	With lock pins		No lock pins	
		Order No.	Order No.	Order No.	Order No.
WGKV 16/Z BK BX	50	2440800000			
WGKV 16/Z GN/YE BX	50	2440720000			
WGKV 16/Z GY BX	50	2440730000			
WGKV 16 BK BX	50		2440790000		
WGKV 16 GN/YE BX	50		2440740000		
WGKV 16 GY BX	50		2440750000		

For the rated voltage of plastic and metal walls, see the "WGK" notes

Ordering data

Type	Qty.	With lock pins		No lock pins	
		Order No.	Order No.	Order No.	Order No.
WGK 16 VP/Z BK BX	50	2440710000			
WGK 16 VP/Z GN/YE BX	50	2440630000			
WGK 16 VP/Z GY BX	50	2440640000			
WGK 16 VP BK BX	50		2440660000		
WGK 16 VP GN/YE BX	50		2440610000		
WGK 16 VP GY BX	50		2440620000		

For the rated voltage of plastic and metal walls, see the "WGK" notes

Variants

The WGK...VP, VWGK 4 and VWGK 6 variants of the WGK series, with an insulating housing and clamping yoke connection on the outside, are specially enhanced for use in potted and through-panel applications. These products are developed for 100 % sealing in completely enclosed units..

WGK variants are used, for example, as device connections for EMC filters or fully insulated transformers.

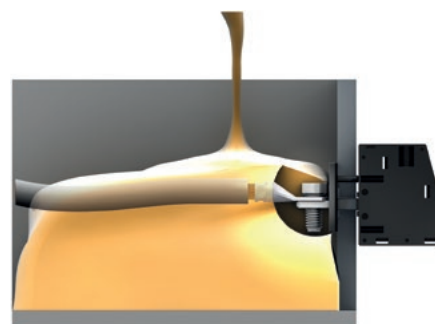

Clamping yoke screw connection

The clamping yoke connection is a proven connection in use around the world today.

Steel clamping yokes made using a stamping and bending process guarantee a vibration proof clamp connection. When the screw on the clamp is tightened, there is a counter effect in the clamping yoke's threaded area which prevents the connection accidentally loosening.

As the screw thread is on an inclined plane, the force is amplified and a very high clamping force is achieved. Weidmüller uses hardened steel with optimised corrosion protection for stability and safety in addition to copper alloys in the contact area for good electrical conductivity.

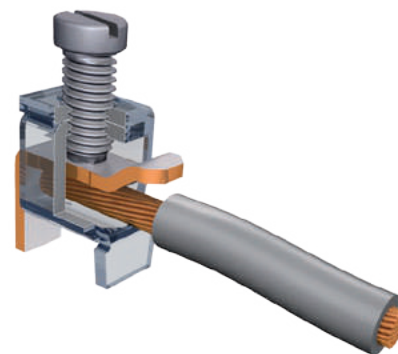

## Feed-through terminals for devices WGK series – connection up to 95 mm<sup>2</sup>

max. clamping range: 35 mm<sup>2</sup>

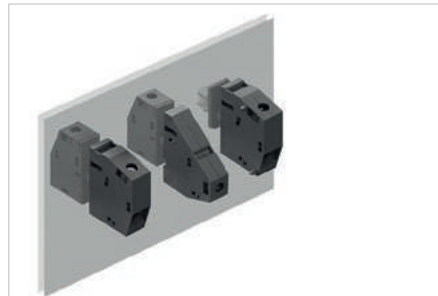

The high-current feed-through terminals of the WGK series provide a universal solution for feeding currents of different magnitude through the enclosure wall.

Various types of connection on the inside, such as cable lug connections which can be encapsulated (WGK ...VP) and maintenance-free clamping yoke screw connections (WGK...) with vertical and horizontal wire insertion provide the optimal connection for any installation situation.

The different peg types allow for a simple and quick assembly of multi-pole blocks.

### Product data

IEC: 690 V / 101 A / 6 - 35 mm<sup>2</sup>  
UL: 600 V / 100 A / AWG 10 - 3



For additional articles and information, refer to [catalog.weidmueller.com](http://catalog.weidmueller.com)

#### Note:

- Clearance and creepage distances to other components must be devised in accordance with the relevant application standard. This can be achieved in the device by full encapsulation or by the use of additional spacer plates.
- Rated data refer only to the component itself. Clearance and creepage distances to other components are to be designed in accordance with the relevant application standards.
- Colours: SW = black; GN/YL = green/yellow; GY = grey
- Additional colours on request
- WGK: Rated voltage plastic walls: 1 - 6 mm = 800 V; metal walls: 1 - 4 mm = 800 V; metal walls: 4 - 6 mm = 690 V
- WGKV: Rated voltage plastic walls: 1 - 6 mm = 800 V; metal walls: 1 - 4 mm = 800 V; metal walls: 4 - 6 mm = 690 V
- WGK...VP: Rated voltage plastic walls: 1 - 6 mm = 800 V; metal walls: 1 - 2.5 mm = 800 V; metal walls: 2.5 - 4 mm = 690 V; metal walls: 4 - 6 mm = 500 V
- Wire-end ferrules are mandatory for stranded wires with more than 19 strands.

### WGK 25



Dimensioned drawing

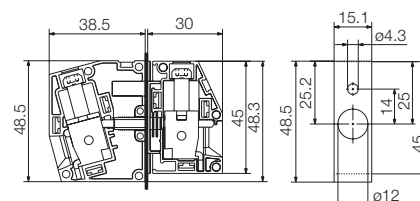

### Technical data

In compliance with IEC 60664-1 / IEC 61984			
Clamping range, max.	mm <sup>2</sup>	4...35	
<b>Solid core H05(07) V-U</b>	<b>mm<sup>2</sup></b>	<b>6...16</b>	
Stranded H07 V-R	mm <sup>2</sup>	10...35	
Flexible H05(07) V-K	mm <sup>2</sup>	6...16	
Flexible with ferrule	mm <sup>2</sup>	4...25	
Ferrule with plastic collar			
Stripping length	mm	18	
Screwdriver blade	mm	1.2 x 6.5	
According to norm			
Tightening torque range	Nm	4...4.5	
<b>Rated current, max.</b>	<b>A</b>	<b>101</b>	
At ambient temperature	20°C	40°C	
For conductor cross-section	mm <sup>2</sup>	25	
Overvoltage category		III III II	
Pollution severity		3 2 2	
<b>Rated voltage</b>		<b>690</b>	
Rated impulse voltage		6	
<b>UL / CUL (Use Group)</b>	<b>B C D</b>		
<b>Rated voltage</b>	<b>V</b>	<b>600 600</b>	
<b>Rated current</b>	<b>A</b>	<b>100 100</b>	
<b>AWG conductor</b>	<b>AWG</b>	<b>10-3</b>	
<b>CSA (Use Group)</b>	<b>B C D</b>		
Rated voltage	V	600 600	
Rated current	A	100 100	
AWG conductor	AWG	10-3	
<b>General data</b>			
Type of insulation material		Wemid (PA)	
UL 94 flammability rating		V-0	
Contact base material		E-Cu	
Material of contact surface		tinned	
Pin dimensions = d	mm		
Solder eyelet Ø = D	mm		
Solder eyelet Ø tolerance	mm		

### Accessories

Note: Refer to the Accessories chapter for additional accessories.

Distance plate	Order No.
DP WGK 25 BK BX	1250590000
DP WGK 25 GY BX	1936710000
DP WGKV 25	1936690000
Screwdriver	
SDIS 1.2X6.5X150	9008420000
Identification systems	
DEK 5/5 MC NE WS	1609801044
DEK 5/6 MC NE WS	1609820000
DEK 5/8 MC NE WS	1856740000

### Ordering data

Type	Qty.	Order No.	
		With lock pins	No lock pins
WGK 25/Z BK BX	50	2444680000	
WGK 25/Z GN/YE BX	50	2444640000	
WGK 25/Z GY BX	50	2444300000	
WGK 25 BK BX	50		2444670000
WGK 25 GN/YE BX	50		2444650000
WGK 25 GY BX	50		2444660000

## WGKV 25



Dimensioned drawing

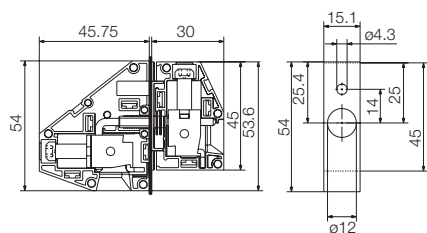

## WGK 25 VP



Dimensioned drawing

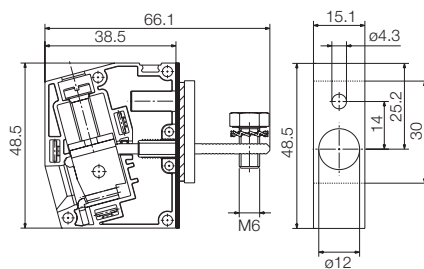

### Ordering data

Type	Qty.	With lock pins		No lock pins	
		Order No.	Order No.	Order No.	Order No.
WGKV 25/Z BK BX	25	2444870000			
WGKV 25/Z GN/YE BX	25	2444810000			
WGKV 25/Z GY BX	25	2444860000			
WGKV 25 BK BX	25		2444840000		
WGKV 25 GN/YE BX	25		2444830000		
WGKV 25 GY BX	25		2444820000		

### Ordering data

Type	Qty.	With lock pins		No lock pins	
		Order No.	Order No.	Order No.	Order No.
WGK 25 VP/Z BK BX	50	2444790000			
WGK 25 VP/Z GN/YE BX	50	2444720000			
WGK 25 VP/Z GY BX	50	2444730000			
WGK 25 VP BK BX	50		2444800000		
WGK 25 VP GN/YE BX	50		2444700000		
WGK 25 VP GY BX	50		2444710000		

Rated voltage for plastic and metal walls such as WGK

## Variants

The WGK...VP, VWGK 4 and VWGK 6 variants of the WGK series, with an insulating housing and clamping yoke connection on the outside, are specially enhanced for use in potted and through-panel applications. These products are developed for 100 % sealing in completely enclosed units..

WGK variants are used, for example, as device connections for EMC filters or fully insulated transformers.

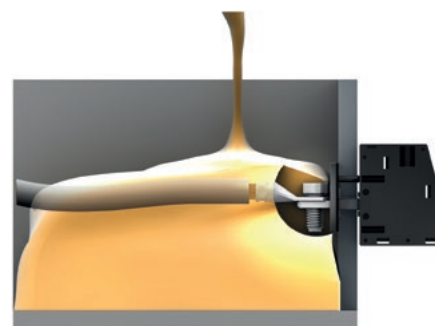

### Clamping yoke screw connection

The clamping yoke connection is a proven connection in use around the world today.

Steel clamping yokes made using a stamping and bending process guarantee a vibration proof clamp connection. When the screw on the clamp is tightened, there is a counter effect in the clamping yoke's threaded area which prevents the connection accidentally loosening.

As the screw thread is on an inclined plane, the force is amplified and a very high clamping force is achieved. Weidmüller uses hardened steel with optimised corrosion protection for stability and safety in addition to copper alloys in the contact area for good electrical conductivity.

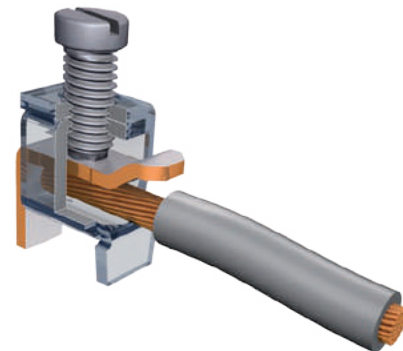

## Feed-through terminals for devices WGK series – connection up to 95 mm<sup>2</sup>

max. clamping range: 50 mm<sup>2</sup>

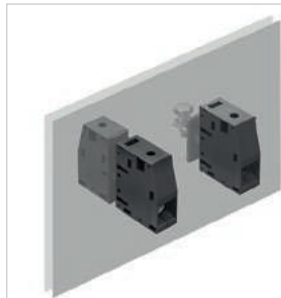

The high-current feed-through terminals of the WGK series provide a universal solution for feeding currents of different magnitude through the enclosure wall.

Various types of connection on the inside, such as cable lug connections which can be encapsulated (WGK ...VP) and maintenance-free clamping yoke screw connections (WGK...) provide the optimal connection for any installation situation.

The different peg types allow for a simple and quick assembly of multi-pole blocks.

### Product data

IEC: 690 V / 150 A / 16 - 50 mm<sup>2</sup>  
UL: 600 V / 150 A / AWG 6 - 1/0



For additional articles and information, refer to [catalog.weidmueller.com](http://catalog.weidmueller.com)

#### Note:

- Clearance and creepage distances to other components must be devised in accordance with the relevant application standard. This can be achieved in the device by full encapsulation or by the use of additional spacer plates.
- Rated data refer only to the component itself. Clearance and creepage distances to other components are to be designed in accordance with the relevant application standards.
- Colours: SW = black; GN/YL = green/yellow; GY = grey
- Additional colours on request
- WGK: Rated voltage plastic walls: 1 - 6 mm = 800 V; metal walls: 1 - 2.5 mm = 800 V; metal walls: 2.5 - 6 mm = 690 V
- Wire-end ferrules are mandatory for stranded wires with more than 19 strands.

### WGK 50



#### Dimensioned drawing

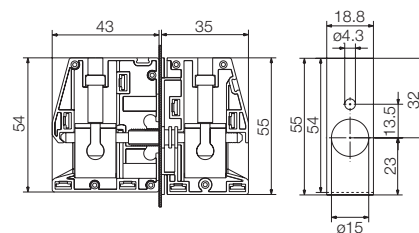

### Technical data

#### In compliance with IEC 60664-1 / IEC 61984

Clamping range, max.	mm <sup>2</sup>	10...50
<b>Solid core H05(07) V-U</b>	<b>mm<sup>2</sup></b>	<b>16...50</b>
Stranded H07 V-R	mm <sup>2</sup>	16...50
Flexible H05(07) V-K	mm <sup>2</sup>	16...50
Flexible with ferrule	mm <sup>2</sup>	10...50
Ferrule with plastic collar		
Stripping length	mm	24
Screwdriver blade	mm	1.2 x 6.5
According to norm		
Tightening torque range	Nm	4...5.5
<b>Rated current, max.</b>	<b>A</b>	<b>150</b>
At ambient temperature	20°C	40°C
For conductor cross-section	mm <sup>2</sup>	50
Overtoltage category		III III II
Pollution severity		3 2 2
<b>Rated voltage</b>		<b>690</b>
Rated impulse voltage		6

#### UL / CUL (Use Group)

	B	C	D
<b>Rated voltage</b>	<b>V</b>	<b>600</b>	<b>600</b>
<b>Rated current</b>	<b>A</b>	<b>150</b>	<b>150</b>
<b>AWG conductor</b>	<b>AWG</b>	<b>6-1/0</b>	
<b>CSA (Use Group)</b>	<b>B</b>	<b>C</b>	<b>D</b>
Rated voltage	V	600	600
Rated current	A	150	150
AWG conductor	AWG	6-1/0	

#### General data

Type of insulation material	Wemid (PA)
UL 94 flammability rating	V-0
Contact base material	E-Cu
Material of contact surface	tinned
Pin dimensions = d	mm
Solder eyelet Ø = D	mm
Solder eyelet Ø tolerance	mm

### Accessories

Note: Refer to the Accessories chapter for additional accessories.

Distance plate	Order No.
DP WGK 50 BK BX	<b>1250610000</b>
DP WGK 50	<b>1937030000</b>
Screwdriver	Order No.
SDIS 1.2X6.5X150	<b>9008420000</b>
Identification systems	Order No.
DEK 5/5 MC NE WS	<b>1609801044</b>
DEK 5/6 MC NE WS	<b>1609820000</b>
DEK 5/8 MC NE WS	<b>1856740000</b>

### Ordering data

Type	Qty.	Order No.	
		With lock pins	No lock pins
WGK 50/Z BK BX	10	<b>2427690000</b>	
WGK 50/Z GN/YE BX	10	<b>2427810000</b>	
WGK 50/Z GY BX	10	<b>2427650000</b>	
WGK 50 BK BX	10		<b>2427680000</b>
WGK 50 GN/YE BX	10		<b>2427660000</b>
WGK 50 GY BX	10		<b>2427640000</b>



## WGK 50 VP



Dimensioned drawing

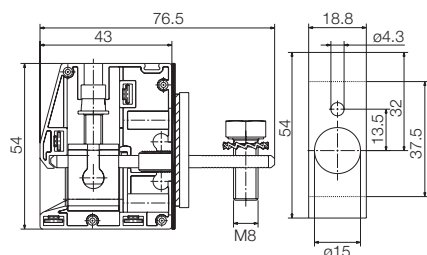

## Variants

The WGK...VP, VWGK 4 and VWGK 6 variants of the WGK series, with an insulating housing and clamping yoke connection on the outside, are specially enhanced for use in potted and through-panel applications. These products are developed for 100 % sealing in completely enclosed units..

WGK variants are used, for example, as device connections for EMC filters or fully insulated transformers.

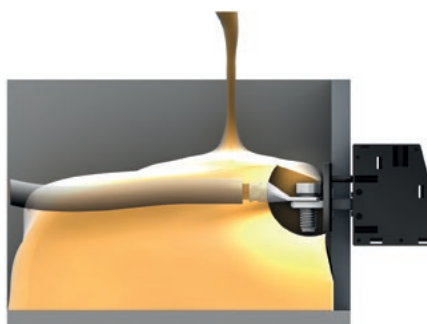

## Ordering data

Type	Qty.	With lock pins		No lock pins	
		Order No.	Order No.	Order No.	Order No.
WGK 50 VP/Z BK BX	10	2428450000			
WGK 50 VP/Z GY BX	10	2428300000			
WGK 50 VP/Z GN/YE BX	10	2428290000			
WGK 50 VP BK BX	10		2428440000		
WGK 50 VP GN/YE BX	10		2428270000		
WGK 50 VP GY BX	10		2428280000		

## Clamping yoke screw connection

The clamping yoke connection is a proven connection in use around the world today. Steel clamping yokes made using a stamping and bending process guarantee a vibration proof clamp connection. When the screw on the clamp is tightened, there is a counter effect in the clamping yoke's threaded area which prevents the connection accidentally loosening. As the screw thread is on an inclined plane, the force is amplified and a very high clamping force is achieved. Weidmüller uses hardened steel with optimised corrosion protection for stability and safety in addition to copper alloys in the contact area for good electrical conductivity.

For the rated voltage of plastic and metal walls, see the "WGK" notes

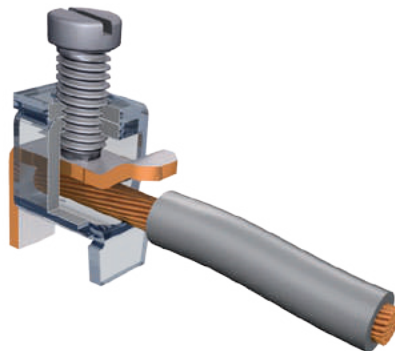

## Feed-through terminals for devices WGK series – connection up to 95 mm<sup>2</sup>

max. clamping range: 95 mm<sup>2</sup>



The high-current feed-through terminals of the WGK series provide a universal solution for feeding currents of different magnitude through the enclosure wall.

Various types of connection on the inside, such as cable lug connections which can be encapsulated (WGK ...VP) and maintenance-free clamping yoke screw connections (WGK...) provide the optimal connection for any installation situation.

The different peg types allow for a simple and quick assembly of multi-pole blocks.

### Product data

IEC: 1000 V / 232 A / 35 - 95 mm<sup>2</sup>  
UL: 600 V / 255 A / AWG 4 - kcmil 250



For additional articles and information, refer to [catalog.weidmueller.com](http://catalog.weidmueller.com)

#### Note:

- Clearance and creepage distances to other components must be devised in accordance with the relevant application standard. This can be achieved in the device by full encapsulation or by the use of additional spacer plates.
- Rated data refer only to the component itself. Clearance and creepage distances to other components are to be designed in accordance with the relevant application standards.
- Colours: SW = black; GN/YL = green/yellow; GY = grey
- Additional colours on request
- WGK: Rated voltage plastic walls: 1-6 mm = 1000 V; metal walls: < 1 mm = 1000 V; metal walls: 1-3.5 mm = 800 V; metal walls: 3.5-5.5 mm = 690 V
- Wire-end ferrules are mandatory for stranded wires with more than 19 strands.

### WGK 95

#### Screw connection



#### Dimensioned drawing

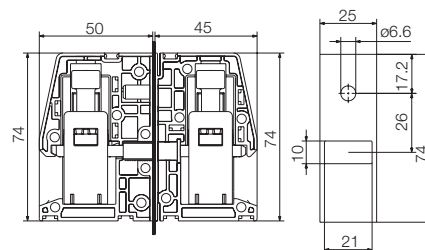

### Technical data

In compliance with IEC 60664-1 / IEC 61984			
Clamping range, max.	mm <sup>2</sup>	35...95	
<b>Solid core H05(07) V-U</b>	<b>mm<sup>2</sup></b>	<b>35...95</b>	
Stranded H07 V-R	mm <sup>2</sup>	35...95	
Flexible H05(07) V-K	mm <sup>2</sup>	35...95	
Flexible with ferrule	mm <sup>2</sup>	35...95	
Ferrule with plastic collar			
Stripping length	mm	27	
Screwdriver blade	mm		
According to norm			
Tightening torque range	Nm	15...20	
<b>Rated current, max.</b>	<b>A</b>	<b>232</b>	
At ambient temperature		20°C	40°C
For conductor cross-section	mm <sup>2</sup>	95	
Overtoltage category		III	III II
Pollution severity		3	2 2
<b>Rated voltage</b>		<b>1000</b>	
Rated impulse voltage		8	
<b>UL / CUL (Use Group)</b>	<b>B C D</b>		
<b>Rated voltage</b>	<b>V</b>	<b>600</b>	<b>600</b>
<b>Rated current</b>	<b>A</b>	<b>255</b>	<b>255</b>
<b>AWG conductor</b>	<b>AWG</b>	<b>4-kcmil</b>	<b>250</b>
<b>CSA (Use Group)</b>	<b>B C D</b>		
Rated voltage	V	600	600
Rated current	A	255	255
AWG conductor	AWG	4-kcmil	250
<b>General data</b>			
Type of insulation material		Wemid (PA)	
UL 94 flammability rating		V-0	
Contact base material		E-Cu	
Material of contact surface		tinned	
Pin dimensions = d	mm		
Solder eyelet Ø = D			
Solder eyelet Ø tolerance	mm		

### Accessories

Note: Refer to the Accessories chapter for additional accessories.

Distance plate	Order No.
DP WGK 95 BK BX	1250620000
DP WGK 95 GY BX	1937020000
<b>Identification systems</b>	
DEK 5/5 MC NE WS	1609801044
DEK 5/6 MC NE WS	1609820000
DEK 5/8 MC NE WS	1856740000

### Ordering data

Type	Qty.	Order No.	
		With lock pins	No lock pins
WGK 95/Z BK BX	10	1250690000	
WGK 95/Z GN/YE BX	10	1937390000	
WGK 95/Z GY BX	10	1937400000	
WGK 95 BK BX	10		1250680000
WGK 95 GN/YE BX	10		1937370000
WGK 95 GY BX	10		1937380000

## WGK 95 F VP

### Cable lug connection



### Dimensioned drawing

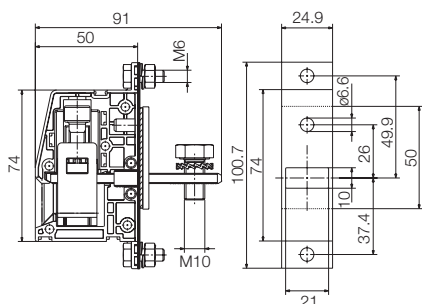

### Variants

The WGK...VP, VWGK 4 and VWGK 6 variants of the WGK series, with an insulating housing and clamping yoke connection on the outside, are specially enhanced for use in potted and through-panel applications. These products are developed for 100 % sealing in completely enclosed units..

WGK variants are used, for example, as device connections for EMC filters or fully insulated transformers.

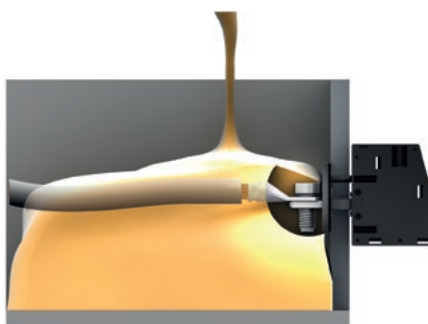

### Ordering data

		With lock pins	No lock pins
<b>Type</b>	<b>Qty.</b>	<b>Order No.</b>	<b>Order No.</b>
WGK 95F VP/Z BK BX	10	1250670000	
WGK 95F VP/Z GN/YE BX	10	1937360000	
WGK 95F VP/Z GY BX	10	1937140000	
WGK 95F VP BK BX	10		1250660000
WGK 95F VP GN/YE BX	10		1937120000
WGK 95F VP GY BX	10		1937130000

### Clamping yoke screw connection

The clamping yoke connection is a proven connection in use around the world today. Steel clamping yokes made using a stamping and bending process guarantee a vibration proof clamp connection. When the screw on the clamp is tightened, there is a counter effect in the clamping yoke's threaded area which prevents the connection accidentally loosening. As the screw thread is on an inclined plane, the force is amplified and a very high clamping force is achieved. Weidmüller uses hardened steel with optimised corrosion protection for stability and safety in addition to copper alloys in the contact area for good electrical conductivity.

For the rated voltage of plastic and metal walls, see the "WGK" notes

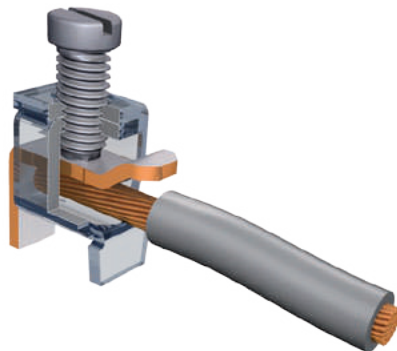



# OMNIMATE® Power Accessories

<b>OMNIMATE® Power Accessories</b>	Strain relief	M.2
	Shielding	M.3
	Coding elements / Anti-twist mechanism / Test plug	M.4
	Screwdrivers	M.5
	Identification systems	M.6

Strain relief

**BV/SV 7.62HP/02 ZE GR**

Strain relief



**BV/SV 7.62HP/04 ZE GR**

Strain relief



**Ordering data**

Colour		Grey
Type	Qty.	Order No.
BV/SV 7.62HP/02 ZE GR		<b>1937550000</b>

**Ordering data**

Colour		Grey
Type	Qty.	Order No.
BV/SV 7.62HP/04 ZE GR		<b>1937560000</b>

M



**BVF 7.62HP SH180 4-6 KIT**

Shield support

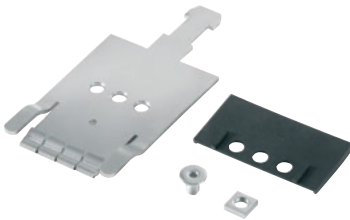

**BVF 7.62HP SH150 4-6 KIT**

Shield support

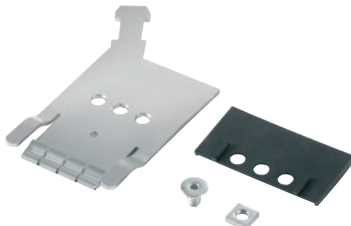

**BVF 7.62HP SH150 4-6 KIT**

Shield support

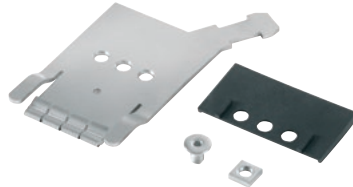

**Ordering data**

Colour	Grey	
Type	Qty.	Order No.
BVF 7.62HP SH180 4-6 KIT		<b>1118470000</b>

**Ordering data**

Colour	Grey	
Type	Qty.	Order No.
BVF 7.62HP SH150 4-6 KIT		<b>1118480000</b>

**Ordering data**

Colour	Grey	
Type	Qty.	Order No.
BVF 7.62HP SH210 4-6 KIT		<b>1118490000</b>



**BV/SV 7.62 KO**

Coding element



**BV/SV 7.62 KO**

Anti-twist mechanism



**PS 2.0 MC**

Test plug

Ø 2.0 mm



- For conductors up to 0.75 mm<sup>2</sup> (AWG 18).
- Gold-plated lantern-type contact.
- Conductor must be soldered to contact in test plug.

**Ordering data**

Typ	Qty.	Order No.
BV/SV 7.62HP KO	100	1937590000

**Ordering data**

Type	Qty.	Order No.
SV 7.62 VDS	1	1853940000

**Ordering data**

Typ	Wire cross-sections	Qty.	Order No.
PS 2.0 MC	≤ 0,75 mm <sup>2</sup>	20	0310000000



## SDI

## VDE-insulated slotted screwdriver

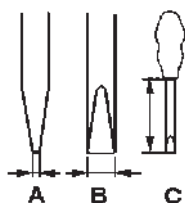

## VDE-insulated slotted screwdriver, SDI

- DIN 7437, ISO 2380/2
- Output acc. to DIN 5264, ISO 2380/1
- SoftFinish® handle



## SD

## Slotted screwdriver with round blade

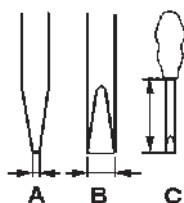

## Slotted screwdriver with round blade, SD

- DIN 5265, ISO 2380/2
- Output acc. to DIN 5264, ISO 2380/1
- ChromTop tip
- SoftFinish® handle



## SDK PH/PZ

## Crosshead screwdriver



## Crosshead screwdriver PH (Philips)

- SDK PH DIN 5262, ISO 8764/2-PH
- Output acc. to ISO 8764-PH
- ChromTop tip
- SoftFinish® grip



## Crosshead screwdriver PZ (Pozidrive)

- SDK PZ DIN 5262, ISO 8764/2-PZ
- Output acc. to ISO 8764-PZ
- ChromTop tip
- SoftFinish® grip



## Ordering data

Type	Dims. (mm)	A	B	C	Order No.
SDI	0,4	2,5	75		9008370000
SDI	0,5	3,0	100		9008380000
SDI	0,6	3,5	100		9008390000
SDI	0,8	4,0	100		9008400000
SDI	1,0	4,5	125		9008910000
SDI	1,0	5,5	125		9008410000
SDI	1,2	6,5	150		9008420000
SDI	1,6	8,0	175		9008430000

## Ordering data

Typ	Dims. (mm)	A	B	C	Order No.
SD	0,4	2,5	75		9009030000
SD	0,5	3,0	80		9008320000
SD	0,6	3,5	100		9008330000
SD	0,8	4,0	100		9008340000
SD	0,8	4,5	125		9009020000
SD	1,0	5,5	150		9008350000
SD	1,2	6,5	150		9009010000

## Ordering data PH

Type	Dims. (mm)	A	B	C	Order No.
SDK PH0	0			60	9008470000
SDK PH1	1			80	9008480000
SDK PH2	2			100	9008490000
SDK PH3	3			150	9008500000

## Ordering data PZ

Type	Dims. (mm)	A	B	C	Order No.
SDK PZ1	1			80	9008530000
SDK PZ2	2			100	9008540000
SDK PZ3	3			150	9008550000

**KSW 4 / KSW 2.5**

**Marking strips**



KSW marking strips are suitable for labelling multi-pole PCB terminals and connectors.

The white, self-adhesive strips are made from a non-PVC, environmentally friendly material. These marking strips provide individual printing, i.e. are suitable for every pitch. Available in two widths: 2.5 and 4.0 mm.

**Technical data**

Material data	
Material	polyester with white surface
Adhesive	acrylic base
Temperature range	-40 °C to +150 °C
Min. bonding temperature	+4 °C
Flammability	self-extinguishing after 15 s

No. of marking strips per sheet
up to 20 poles = 20 strips per sheet
* more than 20 poles = 15 strips per sheet

Ordering example
Order No. 1630060001

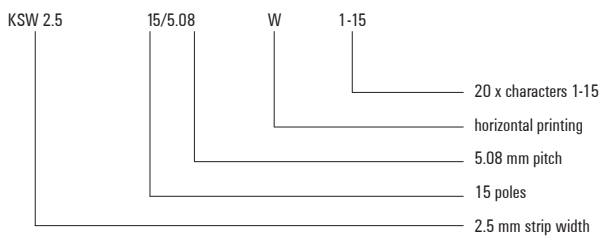

**Printed strips**

KSW 4		Pitch
Char.	7.62 mm	
1-8	1700680001	
1-12	1652270001	
1-16	-	
1-24*	-	

KSW 2.5		Pitch
Char.	7.62 mm	
1-8	-	
1-12	-	
1-16	-	
1-24*	-	

**Blank strips**

	Length of strip		
	50 mm	100 mm	150 mm
KSW 4	1629970000	1629990000	1630010000
KSW 2.5	1629960000	1629980000	1630000000

**Custom printing to specification**

	Length of strip		
	50 mm	100 mm	150 mm
KSW 4	1629910000	1629930000	1629950000
KSW 2.5	1629900000	1629920000	1629940000

**Direct printing**



We can also print directly on your plug and socket connectors to your specification. Please ask for details.



DEK 5

Dekafix system



Dekafix is supplied in packs of 10 cards with 50 individual tags per card.

Dekafix tags are white with black printing as standard.

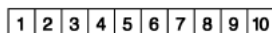

Horizontal printing

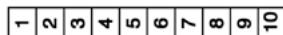

Vertical printing

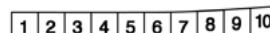

Mounted as strip

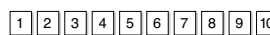

Mounted singly

Technical data

Material data	
Material	polyamide
Temperature range	- 40 °C to +100 °C
Flammability rating	UL 94 V-2
Contents	silicone-free, halogens below minimum detectable level self-extinguishing after 15 s
Mounting	as strips or singly depending on type of carrier
Printing	black printing, standard or to customer specification
Smudge resistance	to DIN IEC 50
Custom printing	according to list or data exchange by diskette or modem
Colour	to international colour code
Max. characters DEK 5	3 horizontal/3 vertical up to 2.5 mm font size

Custom printing to specification

Colour	Order No.	Colour	Order No.	Colour	Order No.	Qty. 500
(Note: please state colour when ordering.)						
○ white	1609810000	● yellow	1609810000	● violet	1609810000	
● black	1609810000	● green	1609810000	● grey	1609810000	
● red	1609810000	● blue	1609810000	● orange	1609810000	

Blank

Colour	Order No.	Colour	Order No.	Colour	Order No.	Qty. 500
● black	1457550000	● yellow	1609801687	● violet	1249860000	
● red	1609801686	● green	1609801688	● grey	1609801691	
● orange	1238340000	● blue	1609801693	○ white	0473360000	

Printed tags

(horizontal only)	Character	Order No.	Character	Horizontal	Vertical										
Tags with individual letters	A	0522761021	50 consecutive numbers	1 ... 50	0473460001										
	B	0522761022	<table border="1"><tr><td>1</td><td>2</td><td>3</td><td>4</td><td>5</td><td>6</td><td>7</td><td>8</td><td>9</td><td>10</td></tr></table>	1	2	3	4	5	6	7	8	9	10	51 ... 100	0473460051
1	2	3	4	5	6	7	8	9	10						
	C	0522761023	<table border="1"><tr><td>11</td><td>12</td><td>13</td><td>14</td><td>15</td><td>16</td><td>17</td><td>18</td><td>19</td><td>20</td></tr></table>	11	12	13	14	15	16	17	18	19	20	to	The last 3 digits of the order No. indicate the first character.
11	12	13	14	15	16	17	18	19	20						
<table border="1"><tr><td>A</td><td>A</td><td>A</td><td>A</td><td>A</td><td>A</td><td>A</td><td>A</td><td>A</td><td>A</td></tr></table>	A	A	A	A	A	A	A	A	A	A	D	0522761024	10 consecutive numbers	951 ... 999	0473460951
A	A	A	A	A	A	A	A	A	A						
	E	0522761025	<table border="1"><tr><td>1</td><td>2</td><td>3</td><td>4</td><td>5</td><td>6</td><td>7</td><td>8</td><td>9</td><td>10</td></tr></table>	1	2	3	4	5	6	7	8	9	10	1 ... 10	0523060001
1	2	3	4	5	6	7	8	9	10						
	F	0522761026	<table border="1"><tr><td>11</td><td>12</td><td>13</td><td>14</td><td>15</td><td>16</td><td>17</td><td>18</td><td>19</td><td>20</td></tr></table>	11	12	13	14	15	16	17	18	19	20	11 ... 20	0523060011
11	12	13	14	15	16	17	18	19	20						
	G	0522761027		to	The last 3 digits of the order No. indicate the first character.										
	H	0522761028	Individual numbers	91 ... 100	0523060091										
	I	0522761029	<table border="1"><tr><td>1</td><td>1</td><td>1</td><td>1</td><td>1</td><td>1</td><td>1</td><td>1</td><td>1</td><td>1</td></tr></table>	1	1	1	1	1	1	1	1	1	1	1	0522660001
1	1	1	1	1	1	1	1	1	1						
	J	0522761030		2	0522660002										
	K	0522761031		bis	The last 3 digits of the order No. indicate the first character.										
	L	0522761032	Various symbols	200	0522660200										
	M	0522761033	<table border="1"><tr><td>L1</td><td>L2</td><td>L3</td><td>N</td><td>PE</td><td>L1</td><td>L2</td><td>L3</td><td>N</td><td>PE</td></tr></table>	L1	L2	L3	N	PE	L1	L2	L3	N	PE	L1, L2, L3, N, PE	0354361187
L1	L2	L3	N	PE	L1	L2	L3	N	PE						
	N	0522761034													
	O	0522761035	Single symbols	plus +	0576261198										
	P	0522761036	<table border="1"><tr><td>+</td><td>+</td><td>+</td><td>+</td><td>+</td><td>+</td><td>+</td><td>+</td><td>+</td><td>+</td></tr></table>	+	+	+	+	+	+	+	+	+	+	minus -	0576261199
+	+	+	+	+	+	+	+	+	+						
	Q	0522761037	<table border="1"><tr><td>L1</td><td>L1</td><td>L1</td><td>L1</td><td>L1</td><td>L1</td><td>L1</td><td>L1</td><td>L1</td><td>L1</td></tr></table>	L1	L1	L1	L1	L1	L1	L1	L1	L1	L1	PE	-
L1	L1	L1	L1	L1	L1	L1	L1	L1	L1						
	R	0522761038		L1	0522361075										
	S	0522761039		L2	0522361076										
	T	0522761040		L3	0522361077										
	U	0522761041		earth	0576261202										
	V	0522761042		earth in circle	0576261203										
	W	0522761043		AC ~	0576261215										
	X	0522761044													
	Y	0522761045	Individual card (state characters and orientation when ordering)		1609810000										
	Z	0522761046	Coloured blank Dekafix (state colour when ordering)		1609801044										
			Coloured printed Dekafix = custom printing (state colour and characters when ordering)		0490790000										



# OMNIMATE® Housings

## Housings for electronics

<b>OMNIMATE® Housings</b> <b>Housings for electronics</b>	OMNIMATE® Housings	Explanation	N.2
		Orientation guide	N.4
<hr/>			
	CH20M component housing series	Explanation	N.6
		Orientation guide	N.14
		Product selection	N.16
<hr/>			
	MICROBOX / TERMINALBOX terminal component housing series	Explanation	N.38
		Product selection	N.40
<hr/>			
	RS profile housing series	Explanation	N.42
		Orientation guide	N.44
		Product selection	N.46
<hr/>			
	Accessories	Mounting foot	N.52
		Identification systems	N.52
		Screwdrivers	N.53

# OMNIMATE® Housings

## Housings for electronics

**The perfect platform for form and function – including terminal layouts, bulk products and “tailor-made suits straight off the rack”.**

Weidmüller’s electronics provide a state-of-the-art platform for electronics applications: for all design types and usage areas. The application and its requirements are the foundation for the housing design:

Component housings using the standard pitch sizes are particularly well suited for standardised electrical cabinet applications.

Because of their excellent flexibility and variability, profile housings are the perfect solution for custom constructions and small-batch series.

The perfect blend of design, connection technology and functionality result in a design that is well tailored to market and application requirements.

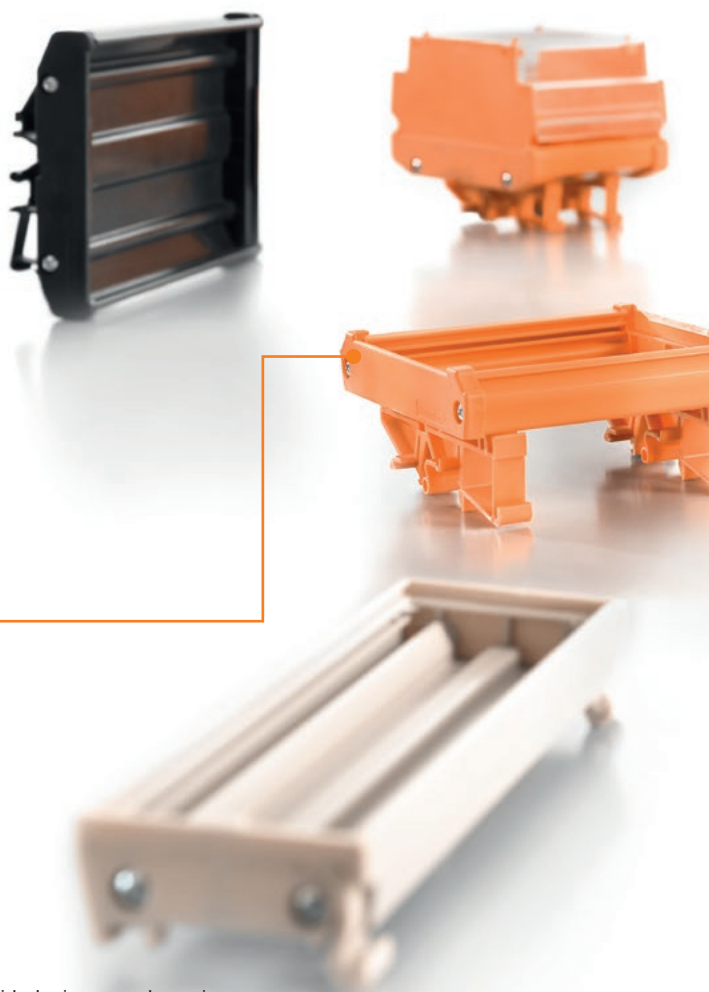

### Flexibility

Profile housing – the perfect solution for custom constructions and smallbatch series.

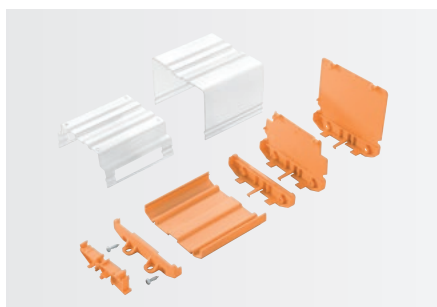

### Innovation

Attention to detail: with the integrated, captive “AutoSet” coding function.



**Reliability**

Weidmüller's legendary quality and well established, proven connection technology guarantee maximum availability for your systems.



**Component housing for mounting on rail**

Component housing: function, form and processing all contribute to a single cohesive unit that offers safety, manufacturing efficiency and usability.

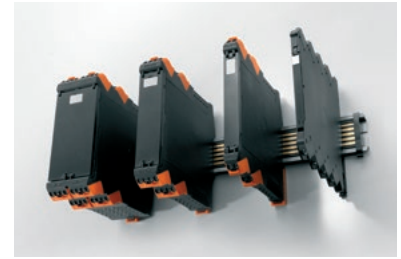

**Assembly housing in profile shape**

Assembly housing in profile shape - the flexible modular system of coloured and transparent plastic profiles and support modules provides the optimum balance between flexibility and efficiency.

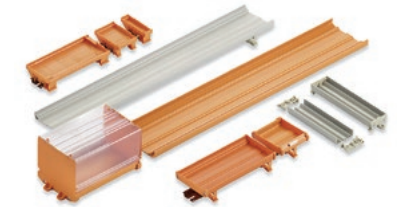

**Accessories**

Comprehensive range of system accessories for integrating your assembled electronics "package" into the system environment - from attachment and connection to marking systems.

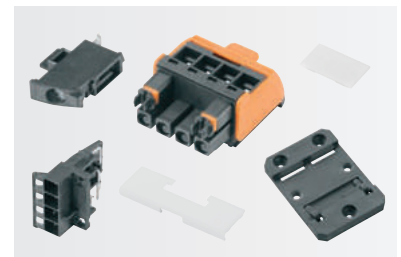

**Efficiency**

Reduce costs and increase productivity: SMT/SMD connectors packed suitably for fully automated production.



### Electronics housings

With 6 housing systems, Weidmüller's electronics housing portfolio offers a platform for electronic applications in any design and for all application areas.

Detailed design information and the most important product-related data is available on the respective product pages. Data sheets and CAD models are available online for download.



### CH20M – Modular component housing



<b>System description (key points)</b>
Scalability
Widths
Design
Production
Application
<b>Connection system</b>
Number of conductors that can be connected
Number of connection levels on each side
<b>Design options</b>
Housing design
PCB layout
Labelling & marking
Standard housing colours (Other colours on request)
<b>Additional features</b>
optional (excerpt)
standard (excerpt)

<b>Component housing system IP 20</b>
<ul style="list-style-type: none"> <li>• 7 housing widths from 6 to 67.5 mm:</li> <li>• 6,1 / 12,5 / 17,5 / 22,5 / 35<sup>1)</sup> / 45 / 67,5</li> <li>• Individually configurable</li> <li>• 100% reflow soldering compatible (automated)</li> <li>• Networked with mounting rail bus</li> </ul>
<b>Connectors (touch-safe both sides)</b>
<ul style="list-style-type: none"> <li>• 4 - 72</li> <li>• 1 - 3</li> </ul>
<b>Individually configurable</b>
<ul style="list-style-type: none"> <li>• Asymmetrical port configuration</li> <li>• Individual processing / modification</li> <li>• Large net layout space of up to 9000 mm<sup>2</sup></li> <li>• Up to 3 flexibly positioned PCBs</li> <li>• Both sides can be fitted with components (underside: + 5mm)</li> <li>• Pad &amp; laser printing</li> <li>• Device markers for female connector</li> <li>• Device markers for hinged cover</li> </ul>
<b>Optional or standard</b>
<ul style="list-style-type: none"> <li>• Integrated mounting rail bus</li> <li>• FE mounting rail contact</li> <li>• Connection areas: lockable slots</li> <li>• Integrated, captive 16-fold "AutoSet" coding</li> <li>• Integrated ejector and plus / minus screws</li> <li>• "Wire ready" and "wire guard" (protection against mis-inserting)</li> <li>• Transparent hinged cover, sealable</li> </ul>

### Legend of symbols

-  Clamping yoke screw connections
-  PUSH IN spring connection
-  Tension clamp connection

Note: 1) On request

### Housing dimensions (exemplary)

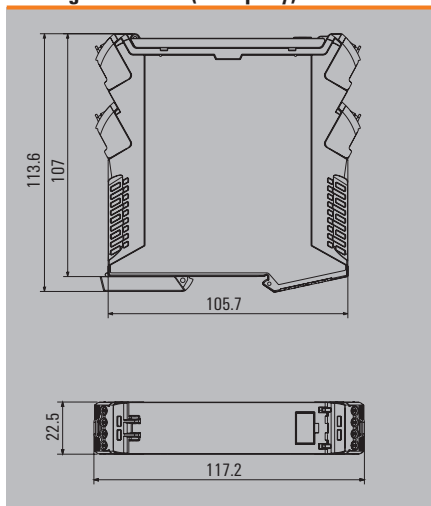



**MICROBOX – Small housing**  
**TERMINALBOX – Terminal housing**

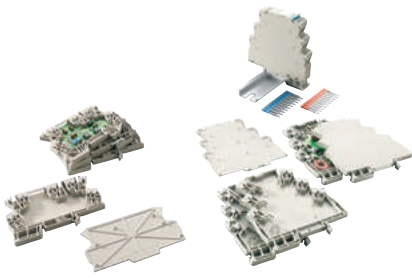

**Small housing IP 20**

- MICROBOX: 6.1 mm
- TERMINALBOX: 6.0 mm
- Miniature plate housing
- Compact enclosure in terminal format
- E.g. for I/O-plate applications

**Connection terminals**

- 4 - 6 
- 2 - 3

**2 versions**

- MICROBOX: closed
- TERMINALBOX: optionally with cover plate

- Pad-print printing



**Optional**

- Cross-connector 32 A

**RS 45-122 – Profile housing variable**

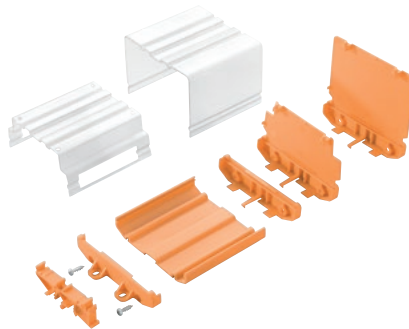

**Variable extruded profile case IP 20**

- Standard length 2 m, optionally cut to size
- Circuit boards 45 to 122 mm
- Precisely cut lengths
- Modules protected with a clear cover

**Female connectors or terminals**

- As needed 
- 1 - 3

**Combinable and a perfect fit**

- See-through covers in 2 sizes
- End plates in 3 sizes
- Standard circuit cards (EURO format)
- Up to 2 PCBs stackable
- Double-sided installation
- Pad-print printing
- Standard connector markings
- Marking strips for the cover hood



**Optional**

- Direct mounting

**RS 70 – Profile housing modular**



**Modular profile case IP 00**

- Individual elements, stackable modular
- Elements of 5 / 10 / 15 / 25 / 30 / 45 mm
- For 68 mm circuit boards
- Tool-free installation
- Sub-assembly accessible when opened

**Female connectors or terminals**

- As needed 
- 1 - 3

**tool-free installation**

- 4 snap-on feet
- 5 different intermediate elements
- Standard circuit boards
- Double-sided installation

- Pad-print printing
- Standard connector markings



**Optional**

- Direct mounting

**Housing dimensions (exemplary)**

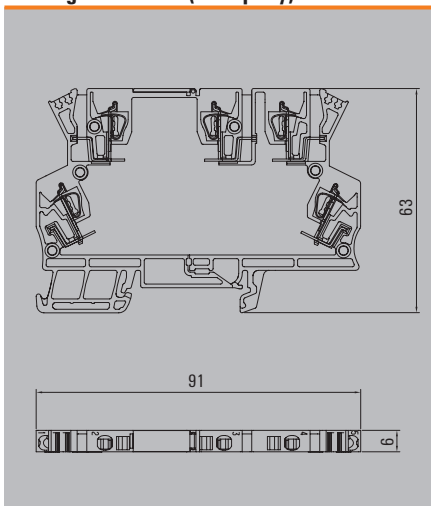

**Housing dimensions (exemplary)**

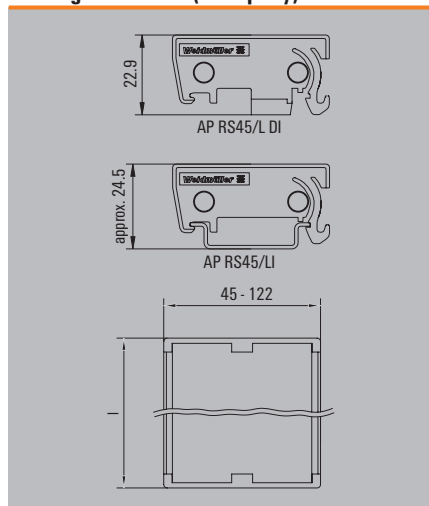

**Housing dimensions (exemplary)**

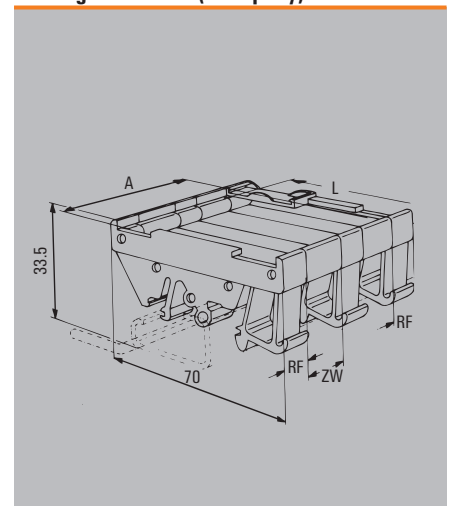

# Individual design by combining form, function and appearance

**CH20M (Component Housing IP 20 Modular) – Weidmüller’s new housing standard – represents the ideal platform for basing customised electronic applications.**

Like a “tailor-made suit straight off the rack”, the ground breaking module concept combines freedom in design with the low cost and planning security of a standard system.

In addition to scalability, a high level of safety and innovative functionality in the application, the system also convinces with superior attention to detail.

The results are quicker installation, user-friendly operation, high operational reliability and resistance to interference. From development to production, the CH20M represents efficiency. It covers all of the requirements for a modern electronics platform built with the future in mind.

## Designed configuration

As many connections as you require and as affordable as you need: scalable connection levels, up to 72 wire connections, individually configurable for each side with 1, 2 or 3 connection levels across all housing widths.

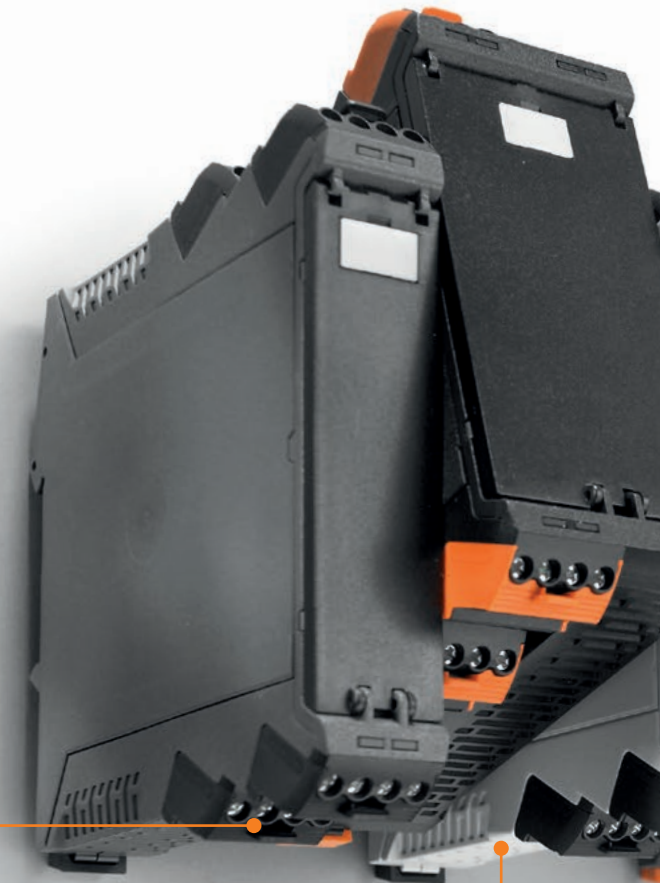

## Designed basic colours

With a focus on the important elements: the unobtrusive housing colours (black graphite, grey graphite and light grey) make a competent impression without distracting from the key operational and display elements.



**Designed printing**

Detailed symbols, data, graphics or text can be printed (with either laser or pad printing) on the large surface available on the housing element.



**Designed optical appearance**

The standard variants, with their modularity and variety, enable you to customise a wide range of designs to fit your application.



**Designed functionality**

Our comprehensive, standardised configuration variants can be further supplemented with modification and design changes to fit your custom needs.



**Designed functional colours**

More operational confidence with functionally appropriate colour coding: three functional colours (red, yellow and blue coding) can be assigned to key industrial applications.



**Designed modifications**

Modifying after the configuration: for example by integrating the pluggable 30-pole BL-I/O LED digital I/O connection level in the front or with the RJ45 socket on the side.



# Power, signals and data are provided, connected and distributed securely and consistently

This customer-friendly bus solution brings power, signals and data to the rail in a quick and reliable manner. When supplying, connecting or distributing within modular applications, the rail bus can replace the tedious individual wiring process with a flexible and uninterrupted system solution. As a result, the wiring overhead and the error rate are both reduced. Redundant functions within complex applications can be efficiently centralised or intelligently distributed.

The system bus is securely integrated within the 35 mm standard mounting rail. The SMD-bus contact block can be reflow-soldered so that it can be completely automatically processed during the component assembly. The resistant, gold-plated contact surfaces ensure a permanent and reliable contact for all housing widths.

### Scalability with no limits

Unique: The integrated connection solution covers all system widths: from the 6 mm slice to the 67 mm large-area housing.

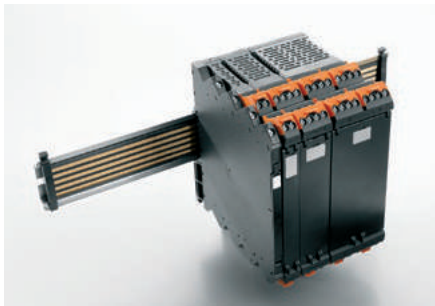

### Easy to service during installation:

Quick: It's easy to replace a module, even in existing modules groups - without any influence on the neighbouring modules.

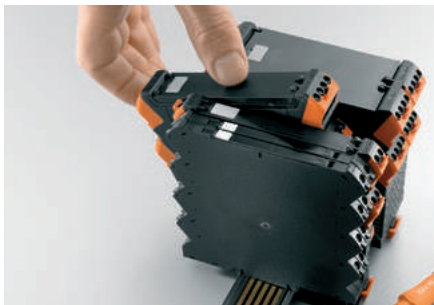

### Unlimited configuration

Compatible: The individual modules can be positioned anywhere on any TS 35 standard top-hat rail. Unused areas are safely covered.

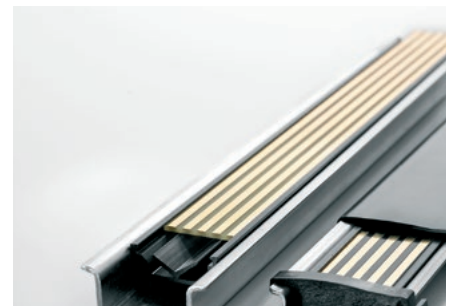

**Maximum availability:**

Reliable: Five fully-galvanised and partially gold-plated twin-arched contacts are used to establish a permanent contact to the rail bus. THR solder flanges ensure that the connection to the circuit board is stable.

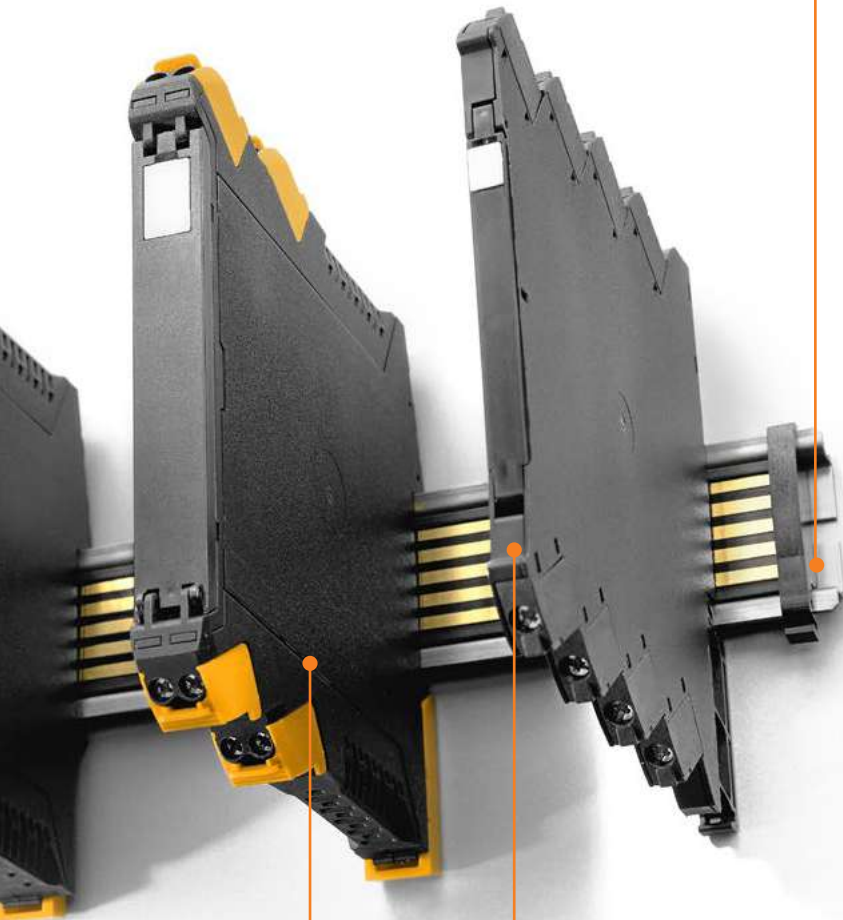
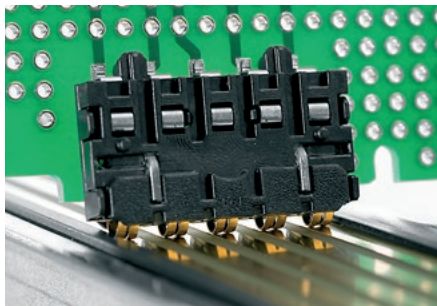

**State-of-the-art processing**

Efficient: The SMD-compatible bus contact block is made from high-temperature-resistant LCP. It is designed for the SMT reflow process and is delivered in machine-ready packaging.

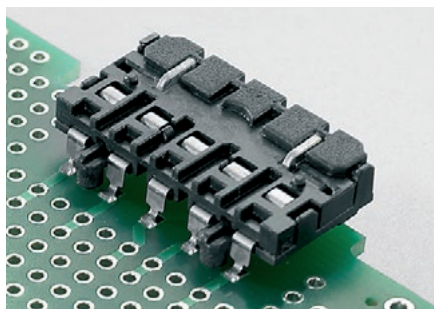

**Affordable assembly**

Fully automatic: No manual post processing is required for the bus contact block – it is processed with the assembly group in a single SMT assembly process.

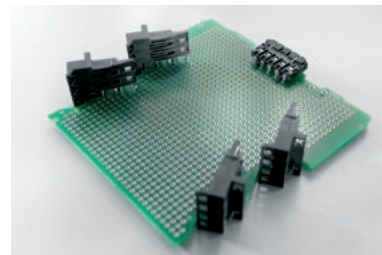

**Safe installation**

Low loss: You can safely avoid undesired bus interruptions and high contact resistances. Maximum facility availability ensured by the gold-plated contact surfaces on the system bus and contact block, as well as the consistent system design.



**More flexibility in design**

From design through production to application - CH20M6 sets the market standard with maximal board space with minimal exterior dimensions as well as allowing fully automatic reflow processing or bus connections.

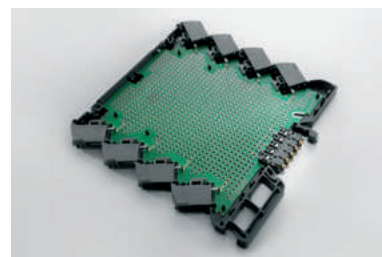

## OMNIMATE® Housing – CH20M-67

The new housing offers new assembly dimensions in the 67.5 mm equipment class.

The CH20M-67 sets new standards on the market as a large-scale housing in terms of flexibility for integrating intricate electronic subassemblies. You can distribute the electronic functions over as many as three printed-circuit boards. The front surface of the housings also has a unique size that can be used for freely laying out the operator interface.

Like all housings of the CH20M family from Weidmüller, the CH20M-67 also supports the connection to the mounting rail bus. The system bus is reliably integrated into the 35-mm standard mounting rail and replaces painstaking and error-prone individual wiring.

### More reliability when connecting the conductors

Series equipment: The built-in conductor wire guard underinsertion protection prevents the hazardous underinsertion of the conductor and protects it from concealed contact faults. Being wire ready ensures that all connecting points are completely open at delivery.



### More speed at installation

Series equipment: Screwed connections with wiring, supported by plus-minus screws, with power tools just right for automatic equipment.

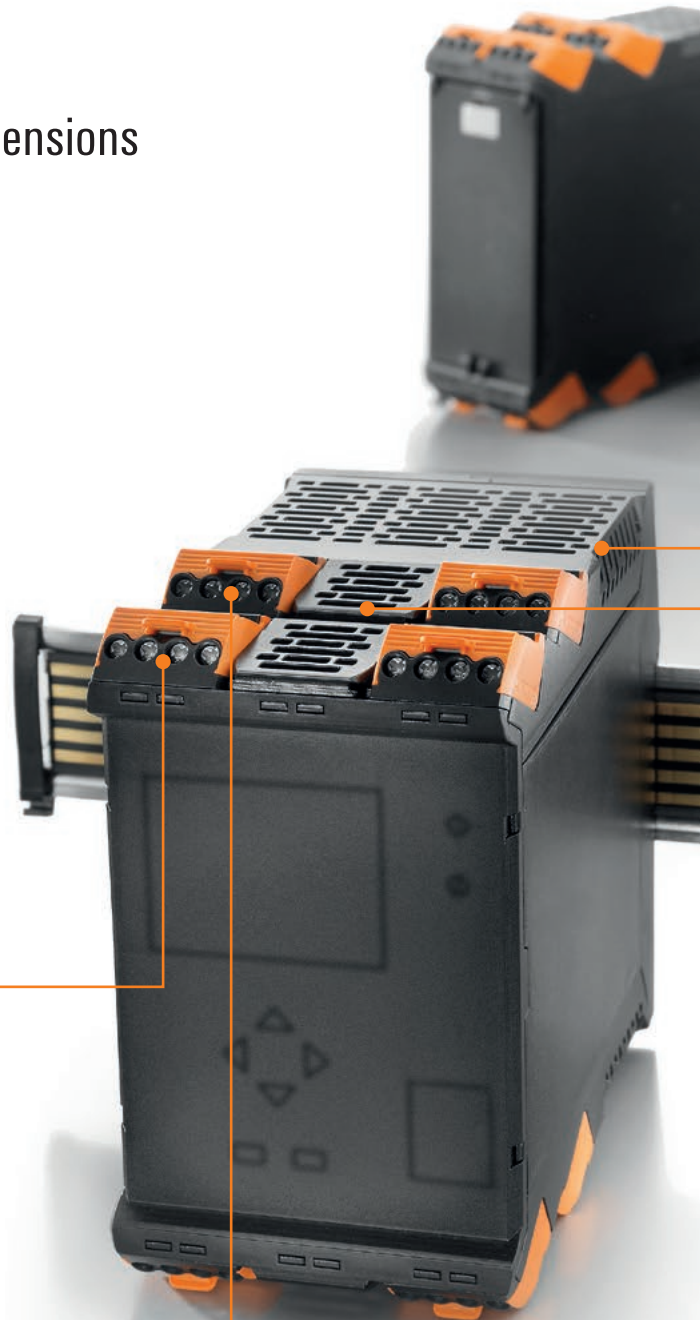



**More layout area**

The side ventilation openings are standard equipment in the semi-cooling design and provide sufficient convection for demanding electronics with the maximised layout area on the printed-circuit board.

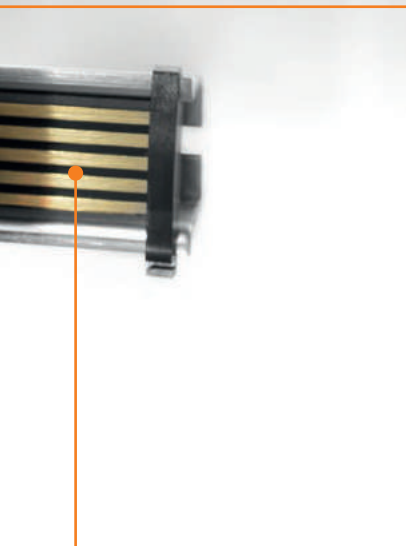

**More flexibility for interfaces**

Unused plug-in stations or connections that are only accessible from the factory side can be reliably and permanently sealed with the optional AD-SHL-SMT cover.



**More stability on the mounting rail**

The built-in click-in base is premounted at the factory which guarantees easy, reliable and vibration-free fastening on the DIN mounting rail. A guide with four points of support provides a solid base.



**More design freedom**

There is room for one to three printed-circuit boards placed on both sides CH20M-67. There is maximum design flexibility since each printed-circuit board can take four freely selectable positions in the housing.

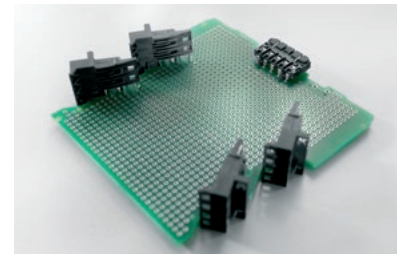

**More mounting space**

The printed-circuit boards can be positioned at a distance of 2.3 mm (and also 5 mm to the housing wall). This gives you the free choice of single- or double-sided assembly.

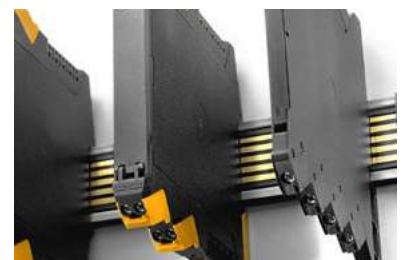

# OMNIMATE® Housing – System CH20M

## System overview

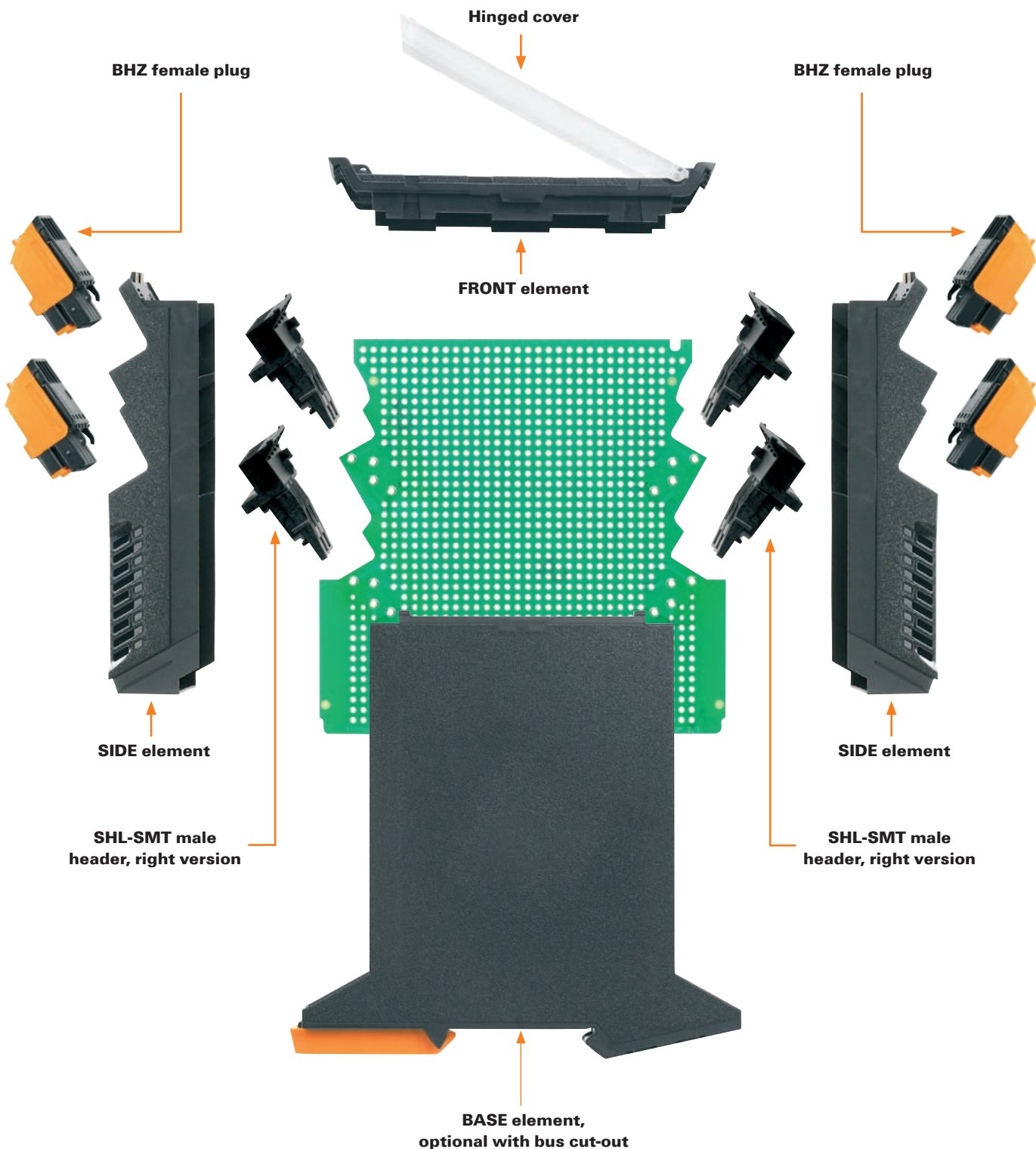

N





Hinged cover, transparent  
**CH20M22 C TP**  
on FRONT element, black  
**CH20M22 F BK**

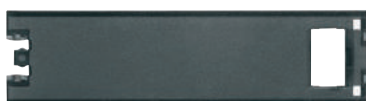

Hinged cover, black  
**CH20M22 C BK**



FRONT element, black  
**CH20M22 F BK**



FRONT element, black:  
for use without hinged cover  
**CH20M22 FC BK**

Connection area (SIDE) with 1 – 3 levels



Black SIDE element  
3-row,  
12 connections  
**CH20M22 S  
PPP BK**



Black SIDE element  
3-row,  
8 connections  
+ RJ45  
**CH20M22 S  
RPP BK**



Black SIDE element  
2-row,  
8 connections  
**CH20M22 S  
PPSC BK**



Black SIDE element  
1-row,  
4 connections  
**CH20M22 S  
PSCSC BK**

Connection area (SIDE) with 1 – 3 levels and  
varying connection configurations



Black SIDE element  
1-row 8 connections-  
**CH20M45 S P2SC/P2SC BK**

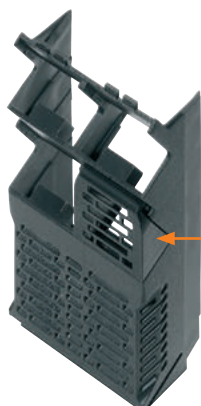

Black SIDE element  
2-row 16 connections  
**CH20M45 S 2PSC/2PSC BK**  
incl. Male header  
**CH20M AD-SHL**



Black SIDE element  
2-row 8 connections  
**CH20M45 S 2PSC/3SC BK**



Black SIDE element  
2-row 8 connections  
**CH20M45 S 3SC/2PSC BK**

# OMNIMATE® Housings

## Component housing system CH20M

The module electronics housing system – CH20M (**C**omponent **H**ousings **IP 20 M**odular) – is designed for seven widths.

Width	Type	Sample kit including wire connection mechanism	Catalogue pages
6.1 mm	CH20M6	1203290000 CH20M6 S-Kit	N.16
12.5 mm	CH20M12	1167190000 CH20M12 S-Kit	N.18
17.5 mm	CH20M17	1255820000 CH20M17 S-Kit	N.20
22.5 mm	CH20M22	1158390000 CH20M22 S-Kit	N.22
35.0 mm	CH20M35	On request	
45.0 mm	CH20M45	1203350000 CH20M45 S-Kit	N.24
67.0 mm	CH20M67	1275810000 CH20M67 S-Kit	N.26

**Note:** The sample kit contains all individual parts for setting up a housing, including the circuit board and wire connection mechanism.

### Colour scale<sup>1)</sup>

- Similar to RAL 9011
- Similar to RAL 7024
- Similar to RAL 7035
- Similar to RAL 5012
- Similar to RAL 1003
- Similar to RAL 3000

**Note 1)** Other colours on request

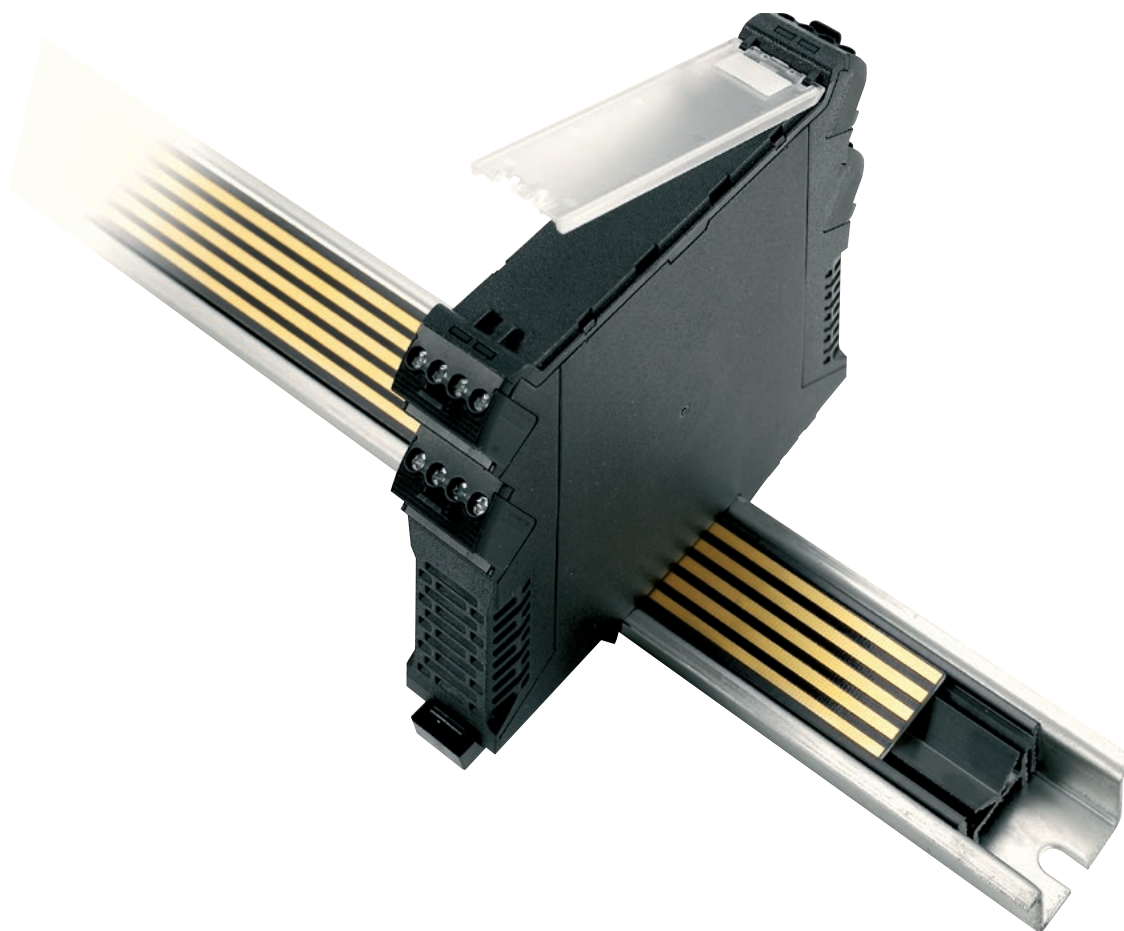

**Housing elements**

**Hinged cover**



**Description/Type**

**COVER (CH20Mxx C xx)**

- Transparent (light or dark)
- Holds itself in place when opened
- Sealable

**Design options**

**Transparent**

- Pad printing
- Markable
- Machinable



**Housing front**



**FRONT (CH20Mxx F xx)**

- Large usable surface for the operational and display elements
- Can be customised

**Design options**

- Laser marking
- With hinges for cover
- Optionally closed (without hinged cover)

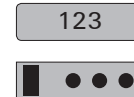

**Connection area**



**SIDE (CH20Mxx S xx)**

- 1 - 3 connection levels
- Can be configured asymmetrically
- For up to 3 circuit boards
- Up to 72 wires can be connected

**Design options**

- Laser marking
- 1 - 3 plugging levels
- Up to 3 circuit boards, can be populated on both sides up to 5 mm on bottom of board
- With or without bus cut-out

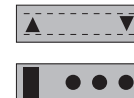

**Housing base**



**BASE (CH20Mxx B xx)**

- For TS 35 DIN rails
- Pre-attached snap-on foot
- ESD-protected (8kV acc. to EN 61000-4-2)
- All elements are permanently snapped in

**Design options**

- Laser marking
- With or without bus cut-out
- Optional FE contact
- Snap-on foot in 2 standard colours (orange + black)



**Connection system**



**BHZ female plug / SHL male header**

- Reflow compatible
- Integrated "AutoSet" coding
- Release clip is standard
- Plug can be removed in direction of operation
- Can be automatically processed

**Design options**

- Headers packaged in box or on tape
- Clamping yoke screw connection
- PUSH IN spring connection (on request)



**Rail bus**



**Bus**

- Integrated in TS 35 DIN rail
- For power, signals and data
- 5 conductor paths (max. 5 A / 63 V)
- SMD-compatible bus contacts (2 A / 63 V)

- Can be shortened to length
- For 7.5 and 15 mm with finger-safe hood
- Pre-assembled on request

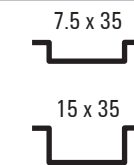

printable (pad printing / laser marking), 123 markable, machinable, variable circuit board position

CH20M6



Modular component housing for electronic components

- 6.1mm wide
- Connection method: PCB terminals, clamping yoke screw connection
- Max. 8 wires

Technical data

Insulating material	PBT
Flammability rating (UL 94)	VO
Rated voltage	250 V AC
Rated current	13 A

Demo/Sample Kit

Type / Version	Qty.	Order No.
SK DEMO CH20M6	1	1203310000
SK S-KIT CH20	1	1203290000

**Note:** Demo kits are already assembled in final configuration (demonstration pieces). S-kits contain individual parts (e.g. for prototyping)

Dimensional drawing

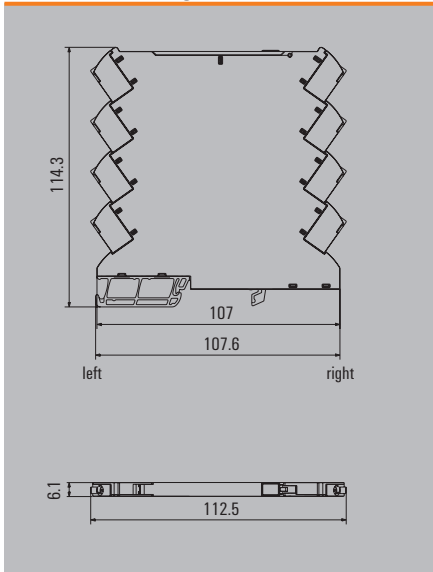

CH20M6 BP

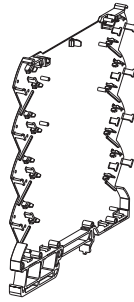

Base shell



Base shell

- For mounting on rail
- Optionally with BUS cut-out

Ordering data

Type / Version	Qty.	Order No.
 Base housing, black CH20M6 BP 4P-4P BK	50	2418600000
 Base housing BUS black CH20M6 BP 4P-4P BUS BK	50	1164630000
 Base housing FE black CH20M6 BP 4P-4P FE BK	50	1164650000



CH20M6 BC

Base lid



Base lid

Ordering data

Type / Version	Qty.	Order No.
 black CH20M6 BC 4P-4P BK	50	2418610000
 black CH20M6 BC 4P-4P BUS BK	50	1164640000

**CH20M6 C**

**Hinged cover**



Hinged cover

**Ordering data**

Type / Version	Qty.	Order No.
 dark transparent CH20M6 C BK	50	2418620000
 transparent CH20M6 C TP	50	1073410000

**Connection system**

**and accessories**

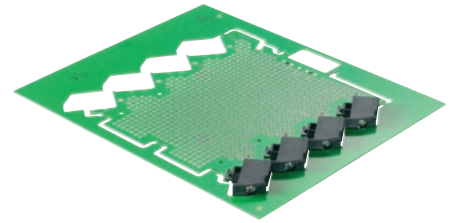

**PCB terminal**

Type / Version	Qty.	Order No.
Left, box packaging LHZ-SMT L 1.5SN BK BX	50	1137870000
Right, box packaging LHZ-SMT R 1.5SN BK BX	50	1137880000
Left, tape-on-reel LHZ-SMT L 1.5SN BK RL	432	2418580000
Right, tape-on-reel LHZ-SMT R 1.5SN BK RL	432	2418590000

**Markers**

Type / Version	Qty.	Order No.
Device marker hinged cover MF 5/7,5 MC NEUTRAL	50	1877680000

CH20M12



Modular component housing for electronic components

- 12.5 mm wide
- Pluggable wire connection
- Max. 12 wires

CH20M6 BP

BASE element

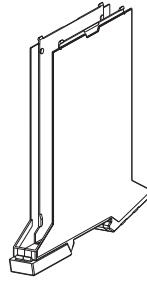

BASE



Base element with pre-attached snap-on foot

- Optionally with BUS cut-out
- Optionally with FE cut-out

CH20M12 S

SIDE element



SIDE



Side element

Technical data

Insulating material	PA6.6
Flammability rating (UL 94)	V0
Rated voltage	250 V AC
Rated current	10 A

Ordering data

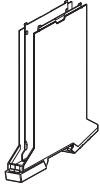
Type / Version	Qty.	Order No.
 Base element, black, Snap-on foot, black CH20M12 B BK/BK	14	1104170000

Ordering data

Type / Version	Qty.	Order No.
 Side element, black, 1-row., for 2 connections* CH20M12 S PSCSC BK	14	1104210000

Demo/Sample Kit

Type / Version	Qty.	Order No.
SK DEMO CH20M12	1	1111630000
SK S-KIT CH20M12	1	1167190000

Note: Demo kits are already assembled in final configuration (demonstration pieces), S-kits contain individual parts (e.g. for prototyping)

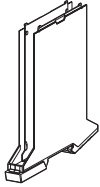
 Base element, black, Snap-on foot, orange CH20M12 B BK/OR	14	1104180000
--	----	------------

 Side element, black, 2-row., for 4 connections CH20M12 S PPSC BK	14	1104200000
---	----	------------

Dimensional drawing

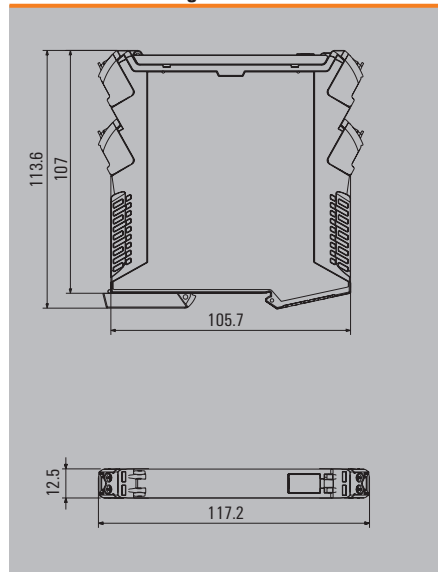

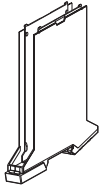
 Base element, black, BUS, Snap-on foot, orange CH20M12 B BUS BK/OR	14	1176980000
---	----	------------

 Side element, black, 3-row., for 6 connections CH20M12 S PPP BK	14	1174280000
--	----	------------

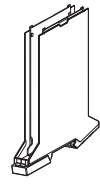
 Base element, black, FE (Version for functional earth), Snap-on foot, orange CH20M12 B FE BK/OR	14	1176990000
---	----	------------

\*) The side itself does not have any connections

**CH20M12 F**

**FRONT Element**

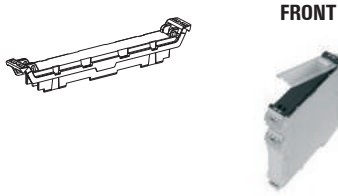

Front element

**CH20M12 C**

**COVER Element**

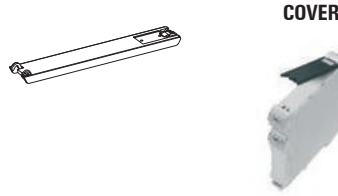

Hinged cover

**Connection system**

**and accessories**

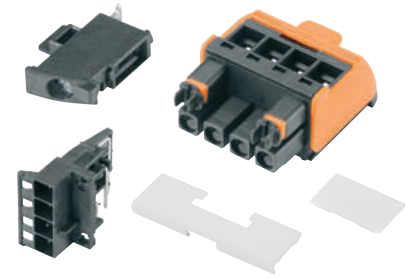

Female plug 2-pole, black,  
Male header 2-pole, black,  
Left and right versions of header

**Ordering data**

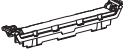
Type / Version	Qty.	Order No.
 Front element black CH20M12 F BK	70	1104190000

**Ordering data**

Type / Version	Qty.	Order No.
 Hinged cover, dark transparent CH20M12 C BK	70	1104240000
 Hinged cover, transparent CH20M12 C TP	70	1104250000

**Female plug**

Type / Version	Qty.	Order No.
Release lever, orange BHZ 5.00/02/90LH BK/DR	150	1063260000
Release lever, black BHZ 5.00/02/90LH BK/BK	150	1069330000
Release lever, blue BHZ 5.00/02/90LH BK/BL	150	1069360000

**Male header**

Type / Version	Qty.	Order No.
Left version, box packaging SHL-SMT 5.00/02GL 4.2BX	156	1069620000
SHL-SMT 5.00/02GL 5.9BX	156	1069750000
Right version, box packaging SHL-SMT 5.00/02GR 4.2BX	156	1069550000
SHL-SMT 5.00/02GR 5.9BX	156	1069680000
Left version, tape-on-reel SHL-SMT 5.00/02GL 4.2RL	260	1069650000
SHL-SMT 5.00/02GL 5.9RL	260	1069780000
Right version, tape-on-reel SHL-SMT 5.00/02GR 4.2RL	260	1069580000
SHL-SMT 5.00/02GR 5.9RL	260	1069720000

**Plug cover**

Type / Version	Qty.	Order No.
Cover, black 2-pole CH20M AD SHL 5.00/02 BK		On request

**Markers**

Type / Version	Qty.	Order No.
Device marker hinged cover ESG 8/13.5/43.3 SAI AU	5	1912130000
Device marker Female plug ESG 6.6/11 BHZ 5.00/02	200	1082490000

CH20M17



Modular component housing for electronic components

- 17.5 mm wide
- Pluggable wire connection
- Max. 18 wires

CH20M17 B

BASE element

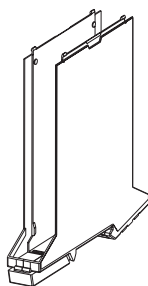

BASE



Base element with pre-attached snap-on foot

- Optionally with BUS cut-out
- Optional with cut-out for functional earth (FE)

CH20M17 S

SIDE element



SIDE



Side element

Technical data

Insulating material	PA6.6
Flammability rating (UL 94)	V0
Rated voltage	250 V AC
Rated current	10 A

Ordering data

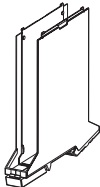
Type / Version	Qty.	Order No.
 Base element, black, Snap-on foot, black CH20M17 B BK/BK	12	1254120000

Ordering data

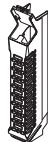
Type / Version	Qty.	Order No.
 Side element, black, 1-row, 3 connections CH20M17 S PSCSC BK		On request

Demo/Sample Kit

Type / Version	Qty.	Order No.
SK DEMO CH20M17	1	On request
SK S-KIT CH20M17	1	1255820000

**Note:** Demo kits are already assembled in final configuration (demonstration pieces), S-kits contain individual parts (e.g. for prototyping)

 Base element, black, Snap-on foot, orange CH20M17 B BK/OR	12	1254130000
---	----	------------

 Side element, black, 2-row, 6 connections CH20M17 S PPSC BK		On request
---	--	------------

Dimensional drawing

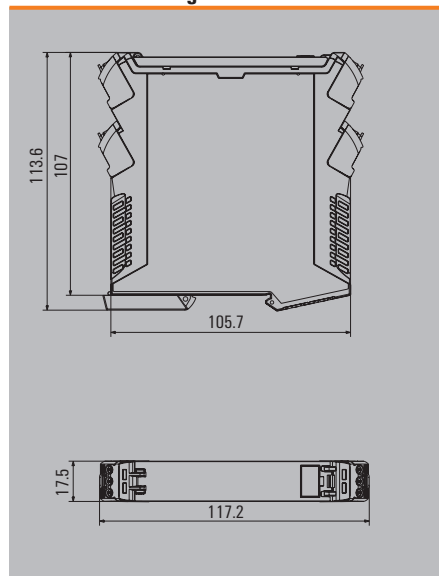

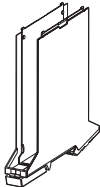
 Base element, black, BUS, Snap-on foot, orange CH20M17 B BUS BK/OR	12	1254180000
--	----	------------

 Side element, black, 3-row, 9 connections CH20M17 S PPP BK	12	1254170000
--	----	------------

 Base element, black, FE, Snap-on foot, orange CH20M17 B FE BK/OR	12	1254190000
--	----	------------



**CH20M17 F**

**FRONT element**

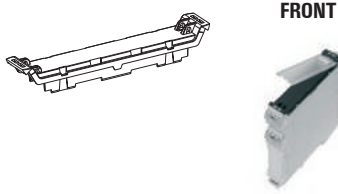

Front element

**CH20M17 C**

**COVER element**

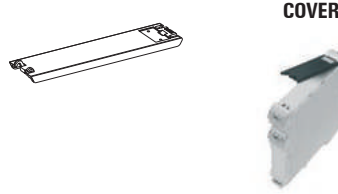

Hinged cover

**Connection system**

**and accessories**

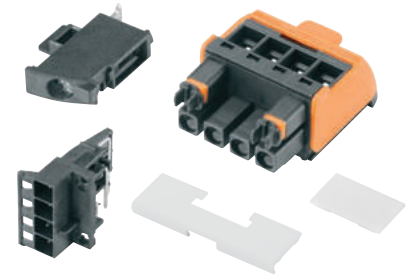

Female plug 3-pole, black  
Male header 3-pole, black,  
Left and right versions of header

**Ordering data**

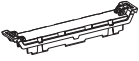
Type / Version	Qty.	Order No.
 Front element, black CH20M17 F BK	50	1254140000

**Ordering data**

Type / Version	Qty.	Order No.
 Hinged cover, dark transparent CH20M17 C BK	50	1254150000
 Hinged cover, transparent CH20M17 C TP	50	1254160000

**Female plug**

Type / Version	Qty.	Order No.
Release lever, orange BHZ 5.00/03/90LH BK/DR	108	1063270000
Release lever, black BHZ 5.00/03/90LH BK/BK	108	1069340000
Release lever, blue BHZ 5.00/03/90LH BK/BL	108	1069370000

**Male header**

Type / Version	Qty.	Order No.
Left version, box packaging SHL-SMT 5.00/03GL 1.5BX	120	1063210000
SHL-SMT 5.00/03GL 4.2BX	120	1069630000
SHL-SMT 5.00/03GL 5.9BX	120	1069760000
Right version, box packaging SHL-SMT 5.00/03GR 1.5BX	120	1063140000
SHL-SMT 5.00/03GR 4.2BX	120	1069560000
SHL-SMT 5.00/03GR 5.9BX	120	1069690000
Left version, tape-on-reel SHL-SMT 5.00/03GL 1.5RL	175	1063240000
SHL-SMT 5.00/03GL 4.2RL	175	1069660000
SHL-SMT 5.00/03GL 5.9RL	175	1069790000
Right version, tape-on-reel SHL-SMT 5.00/03GR 1.5RL	175	1063170000
SHL-SMT 5.00/03GR 4.2RL	175	1069590000
SHL-SMT 5.00/03GR 5.9RL	175	1069730000

**Plug cover**

Type / Version	Qty.	Order No.
Cover, black 3-pole CH20M AD SHL 5.00/03 BK	50	1254110000

**Markers**

Type / Version	Qty.	Order No.
Device marker hinged cover ESG 8/13.5/43.3 SAI AU	5	1912130000
Device marker Female plug ESG 6.6/15 BHZ 5.00/03	200	1082520000

CH20M22



Modular component housing for electronic components

- 22.5 mm wide
- Pluggable wire connection
- Max. 24 wires

CH20M22 B

BASE element

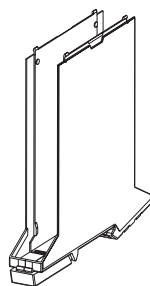

BASE



Base element with pre-attached snap-on foot

- Optionally with BUS cut-out
- Optional with cut-out for functional earth (FE)

CH20M22 S

SIDE element



SIDE



Side element

Technical data

Insulating material	PA6.6
Flammability rating (UL 94)	V0
Rated voltage	250 V AC
Rated current	10 A

Ordering data

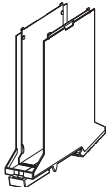
Type / Version	Qty.	Order No.
		
Base element, black, Snap-on foot, black CH20M22 B BK/BK	10	2418630000

Ordering data

Type / Version	Qty.	Order No.
		
Side element, black, 1-row, 4 connections CH20M22 S PSCSC BK	10	1080630000

Demo/Sample Kit

Type / Version	Qty.	Order No.
SK DEMO CH20M22	1	1105600000
SK S-KIT CH20M22	1	1158390000

**Note:** Demo kits are already assembled in final configuration (demonstration pieces), S-kits contain individual parts (e.g. for prototyping)

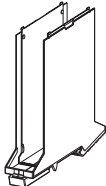
		
Base element, black, Snap-on foot, orange CH20M22 B BK/OR	10	1104450000

		
Side element, black, 2-row, 8 connections CH20M22 S PPSC BK	10	2418650000

Dimensional drawing

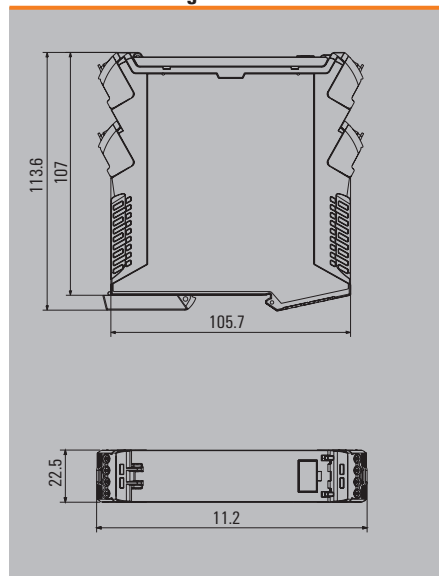

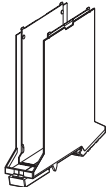
		
Base element, black, BUS, Snap-on foot, orange CH20M22 B BUS BK/OR	10	1177000000

		
Side element, black, 3-row 12 connections CH20M22 S PPP BK	10	1139790000

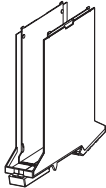
		
Base element, black, FE, Snap-on foot, orange CH20M22 B FE BK/OR	10	1177010000

--	--	--

**CH20M22 F**

**FRONT element**

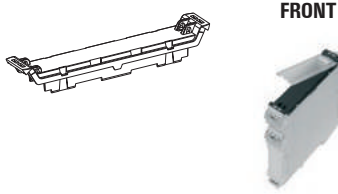

Front element

**CH20M22 C**

**COVER element**

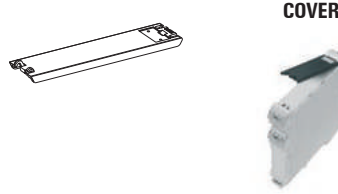

Hinged cover

**Connection system**

**and accessories**

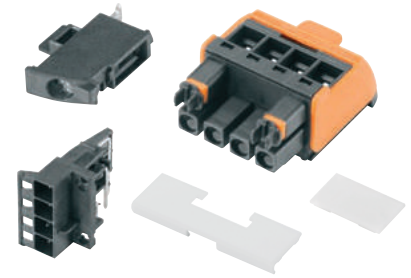

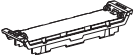
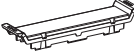

Female plug 4-pole, black  
Male header 4-pole, black,  
Left and right versions of header

**Ordering data**

Type / Version	Qty.	Order No.
		
Front element, black CH20M22 F BK	50	2418640000
		
Front element, closed, black CH20M22 FC BK	50	1209350000

**Ordering data**

Type / Version	Qty.	Order No.
		
Hinged cover, dark transparent CH20M22 C BK	50	2418670000
		
Hinged cover, transparent CH20M22 C TP	50	1073420000

**Female plug**

Type / Version	Qty.	Order No.
Release lever, orange BHZ 5.00/04/90LH BK/DR	78	1063280000
Release lever, black BHZ 5.00/04/90LH BK/BK	78	1069350000
Release lever, blue BHZ 5.00/04/90LH BK/BL	78	1069380000

**Male header**

Type / Version	Qty.	Order No.
Left version, box packaging SHL-SMT 5.00/04GL 1.5BX	120	1063220000
SHL-SMT 5.00/04GL 4.2BX	120	1069640000
SHL-SMT 5.00/04GL 5.9BX	120	1069770000
Right version, box packaging SHL-SMT 5.00/04GR 1.5BX	120	1063150000
SHL-SMT 5.00/04GR 4.2BX	120	1069570000
SHL-SMT 5.00/04GR 5.9BX	120	1069710000
Left version, tape-on-reel SHL-SMT 5.00/04GL 1.5RL	130	1063250000
SHL-SMT 5.00/04GL 4.2RL	130	1069670000
SHL-SMT 5.00/04GL 5.9RL	130	1069810000
Right version, tape-on-reel SHL-SMT 5.00/04GR 1.5RL	130	1063180000
SHL-SMT 5.00/04GR 4.2RL	130	1069610000
SHL-SMT 5.00/04GR 5.9RL	130	1069740000

**Plug cover**

Type / Version	Qty.	Order No.
Cover, black 4-pole CH20M AD SHL 5.00/04 BK	50	1221310000

**Markers**

Type / Version	Qty.	Order No.
Device marker hinged cover ESG 8/13.5/43.3 SAI AU	5	1912130000
Device marker Female plug ESG 6.6/20 BHZ 5.00/04	200	1082540000

CH20M45



Modular component housing for electronic components

- 45 mm wide
- Pluggable wire connection
- Max. 48 wires

CH20M45 B

BASE element

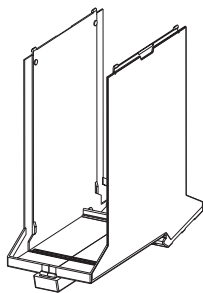

BASE



Base element with pre-attached snap-on foot

- Optionally with BUS cut-out
- Optional with cut-out for functional earth (FE)

CH20M45 S

SIDE element

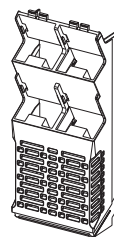

SIDE



Side element

- Symmetrical versions

Technical data

Insulating material	PA6.6
Flammability rating (UL 94)	V0
Rated voltage	250 V AC
Rated current	10 A

Ordering data

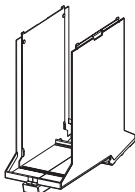
Type / Version	Qty.	Order No.
		
Base element, black, Snap-on foot, black CH20M45 B BK/BK	10	1104400000

Ordering data

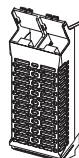
Type / Version	Qty.	Order No.
		
Side element, black, 1-row, 8 connections CH20M45 S P2SC/P2SC BK	6	1166180000

Demo/Sample Kit

Type / Version	Qty.	Order No.
SK DEMO CH20M45	1	1111640000
SK S-KIT CH20M45	1	1203350000

**Note:** Demo kits are already assembled in final configuration (demonstration pieces), S-kits contain individual parts (e.g. for prototyping)

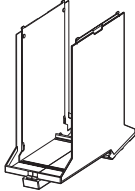
		
Base element, black, BUS, Snap-on foot, orange CH20M45 B BK/OR	10	1104410000

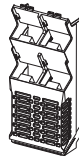
		
Side element, black, 2-row, 16 connections CH20M45 S 2PSC/2PSC BK	6	1111720000

Dimensional drawing

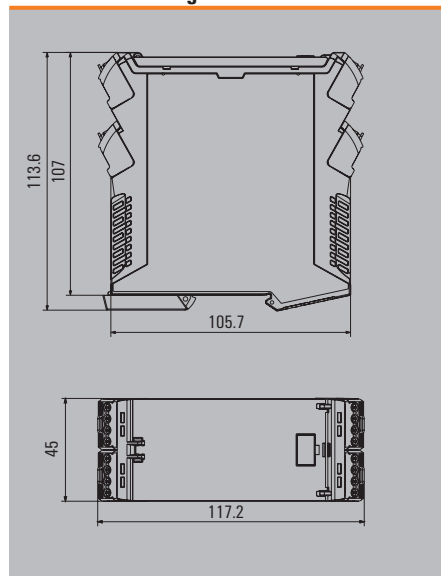

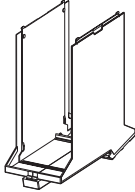
		
Base element, black, FE, Snap-on foot, orange CH20M45 B FE BK/OR	10	1177020000

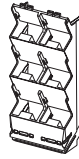
		
Side element, black, 3-row, 24 connections CH20M45 S 3P/3P BK	6	1137730000

**CH20M45 S**

**SIDE element**

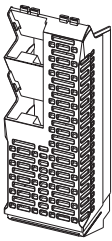

Side element  
• Asymmetrical versions

**CH20M45 C / CH20M45 F**

**COVER element  
FRONT element**



Hinged cover

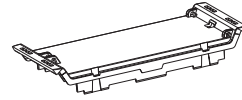

Front element

**COVER**



**FRONT**





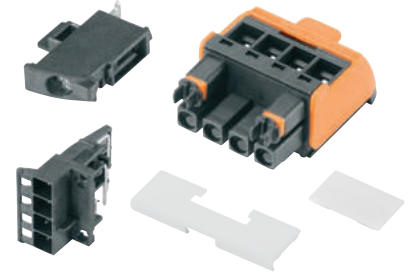

**Connection system**

**and accessories**



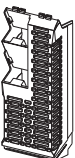

Female plug 4-pole, black,  
Male header 4-pole, black,  
Left and right versions of header

**Ordering data**

Type / Version	Qty.	Order No.
 Side element, black, 1-row, 4 connections CH20M45 S P2SC/3SC BK	6	On request
 Side element, black, 1-row, 4 connections CH20M45 S 3SC/P2SC BK	6	On request
 Side element, black, 2-row 8 connections CH20M45 S 2PSC/3SC BK	6	1137740000
 Side element, black, 2-row 8 connections CH20M45 S 3SC/2PSC BK	6	1137750000

**Ordering data**

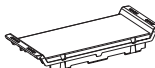
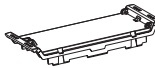
Type / Version	Qty.	Order No.
 Hinged cover, transparent CH20M45 C TP	30	1104440000
 Hinged cover, dark transparent CH20M45 C BK	30	1104430000
 Front element, closed, black CH20M45 FC BK	30	1164800000
 Front element, black CH20M45 F BK	30	1104420000

**Female plug**

Type / Version	Qty.	Order No.
Release lever, orange BHZ 5.00/04/90LH BK/DR	78	1063280000
Release lever, black BHZ 5.00/04/90LH BK/BK	78	1069350000
Release lever, blue BHZ 5.00/04/90LH BK/BL	78	1069380000

**Male header**

Type / Version	Qty.	Order No.
Left version, box packaging SHL-SMT 5.00/04GL 1.5BX	120	1063220000
SHL-SMT 5.00/04GL 4.2BX	120	1069640000
SHL-SMT 5.00/04GL 5.9BX	120	1069770000
Right version, box packaging SHL-SMT 5.00/04GR 1.5BX	120	1063150000
SHL-SMT 5.00/04GR 4.2BX	120	1069570000
SHL-SMT 5.00/04GR 5.9BX	120	1069710000
Left version, tape-on-reel SHL-SMT 5.00/04GL 1.5RL	130	1063250000
SHL-SMT 5.00/04GL 4.2RL	130	1069670000
SHL-SMT 5.00/04GL 5.9RL	130	1069810000
Right version, tape-on-reel SHL-SMT 5.00/04GR 1.5RL	130	1063180000
SHL-SMT 5.00/04GR 4.2RL	130	1069610000
SHL-SMT 5.00/04GR 5.9RL	130	1069740000

**Plug cover**

Type / Version	Qty.	Order No.
Cover, black 4-pole CH20M AD SHL 5.00/04 BK	50	1221310000

**Markers**

Type / Version	Qty.	Order No.
Device marker hinged cover ESG 8/13.5/43.3 SAI AU	5	1912130000
Device marker Female plug ESG 6.6/20 BHZ 5.00/04	200	1082540000

CH20M67



Modular component housing for electronic components

- 67.5 mm wide
- Pluggable wire connection
- Max. 72 wires

CH20M67 B

BASE element

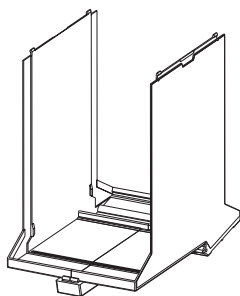

BASE



Base element with pre-attached snap-on foot

- Optionally with BUS cut-out
- Optional with cut-out for functional earth (FE)

CH20M67 S

SIDE element

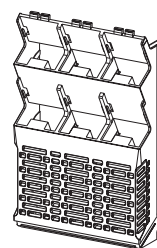

SIDE



Side element

- Symmetrical versions

Technical data

Insulating material	PA6.6
Flammability rating (UL 94)	V0
Rated voltage	250 V AC
Rated current	10 A

Ordering data

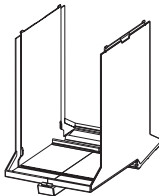
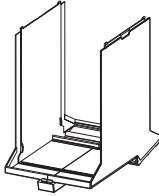
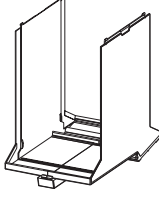
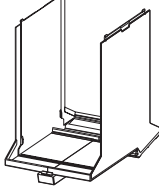
Type / Version	Qty.	Order No.
 Base element, black, Snap-on foot, black CH20M67 B BK/BK	4	1235270000
 Base element, black, Snap-on foot, orange CH20M67 B BK/O	4	1235250000
 Base element, black, BUS, Snap-on foot, orange CH20M67 B BUS BK/OR	4	1247240000
 Base element, black, FE, Snap-on foot, orange CH20M45 B FE BK/OR	4	1247250000

Ordering data

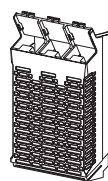
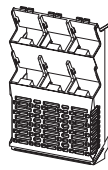
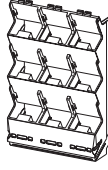
Type / Version	Qty.	Order No.
 Side element, black, 1-row, 12 connections CH20M67 S P2SC/P2SC/P2SC BK	4	On request
 Side element, black, 2-row, 24 connections CH20M67 S 2PSC/2PSC/2PSC BK	4	1235320000
 Side element, black, 3-row 36 connections CH20M67 S 3P/3P/3P BK	4	On request

Demo/Sample Kit

Type / Version	Qty.	Order No.
SK DEMO CH20M67	1	On request
SK S-KIT CH20M67	1	1275810000

**Note:** Demo kits are already assembled in final configuration (demonstration pieces), S-kits contain individual parts (e.g. for prototyping)

Dimensional drawing

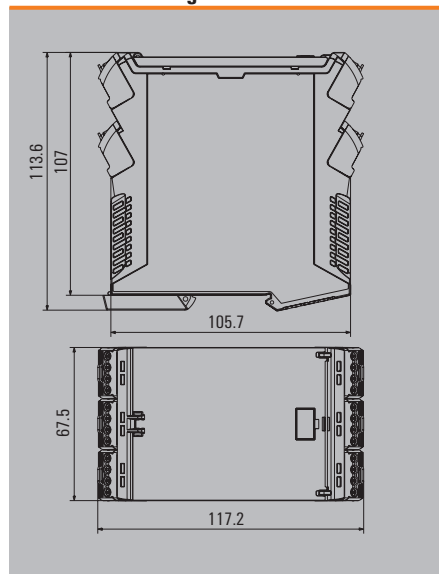

**CH20M67 F**

**FRONT element**

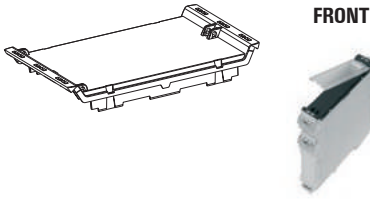

Front element

**CH20M67 C**

**COVER element**

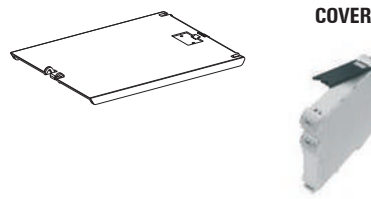

Hinged cover

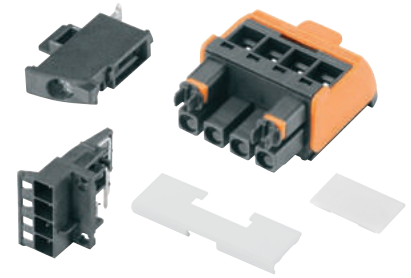

**Connection system**

**and accessories**

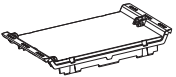

Female plug 4-pole, black  
Male header 4-pole, black  
Left and right versions of header

**Ordering data**

Type / Version	Qty.	Order No.
 Front element, black CH20M67 F BK	30	On request
 Front element, closed, black CH20M67 FC BK	30	1235310000

**Ordering data**

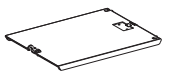
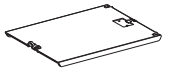
Type / Version	Qty.	Order No.
 Hinged cover, dark transparent CH20M67 C BK	30	On request
 Hinged cover, transparent CH20M67 C TP	30	On request

**Female plug**

Type / Version	Qty.	Order No.
Release lever, orange BHZ 5.00/04/90LH BK/DR	78	1063280000
Release lever, black BHZ 5.00/04/90LH BK/BK	78	1069350000
Release lever, blue BHZ 5.00/04/90LH BK/BL	78	1069380000

**Male header**

Type / Version	Qty.	Order No.
Left version, box packaging SHL-SMT 5.00/04GL 1.5BX	120	1063220000
SHL-SMT 5.00/04GL 4.2BX	120	1069640000
SHL-SMT 5.00/04GL 5.9BX	120	1069770000
Right version, box packaging SHL-SMT 5.00/04GR 1.5BX	120	1063150000
SHL-SMT 5.00/04GR 4.2BX	120	1069570000
SHL-SMT 5.00/04GR 5.9BX	120	1069710000
Left version, tape-on-reel SHL-SMT 5.00/04GL 1.5RL	130	1063250000
SHL-SMT 5.00/04GL 4.2RL	130	1069670000
SHL-SMT 5.00/04GL 5.9RL	130	1069810000
Right version, tape-on-reel SHL-SMT 5.00/04GR 1.5RL	130	1063180000
SHL-SMT 5.00/04GR 4.2RL	130	1069610000
SHL-SMT 5.00/04GR 5.9RL	130	1069740000

**Plug cover**

Type / Version	Qty.	Order No.
Cover, black 4-pole CH20M AD SHL 5.00/04 BK	50	1221310000

**Markers**

Type / Version	Qty.	Order No.
Device marker hinged cover ESG 8/13.5/43.3 SAI AU	5	1912130000
Device marker Female plug ESG 6.6/20 BHZ 5.00/04	200	1082540000

LHZ

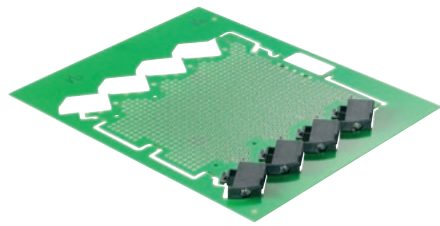

THR PCB terminal for 6 mm housings,  
CH20M6 reflow-compatible,  
Pole count: 1  
solder pin length: 1.5 mm  
Orientation: 90°

Technical data

Insulating material	LCP
Flammability rating (UL 94)	V0
Rated voltage	250 V
Rated current	13 A

Conductors that can be connected

Clamping range	0.13 mm <sup>2</sup> - 2.5 mm <sup>2</sup>
Wire cross-section, AWG, min.	AWG 26 - AWG 14
Solid, min. H05(07) V-U	0.2 mm <sup>2</sup> - 2.5 mm <sup>2</sup>
Flexible, min. H05(07) V-K	0.2 mm <sup>2</sup> - 2.5 mm <sup>2</sup>
With wire-end ferrule with DIN 46 228/4, min.	0.2 mm <sup>2</sup> - 2.5 mm <sup>2</sup>

Rated data according to DIN IEC

Rated voltage for surge voltage class / contamination degree III/3	250 V
Rated impulse voltage for surge voltage class / contamination degree III/3	4 kV
Rated voltage for surge voltage class / contamination degree III/2	320 V
Rated impulse voltage for surge voltage class / contamination degree III/2	4 kV
Rated voltage for surge voltage class / contamination degree II/2	500 V
Rated impulse voltage for surge voltage class / contamination degree II/2	4 kV

Dimensional drawing

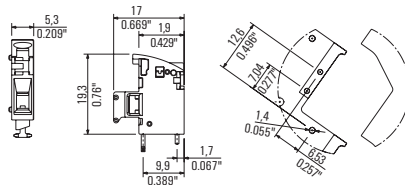

Version left

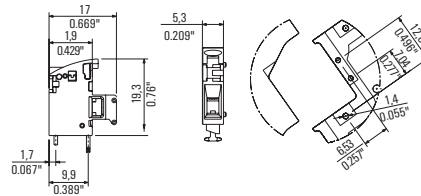

Version right

LHZ



Ordering data

Type / Version	Qty.	Order No.
LHZ-SMT L 1.5SN BK RL Left version, tape-on-reel	432	2418580000
LHZ-SMT R 1.5SN BK RL Right version, tape-on-reel	432	2418590000

Derating curve

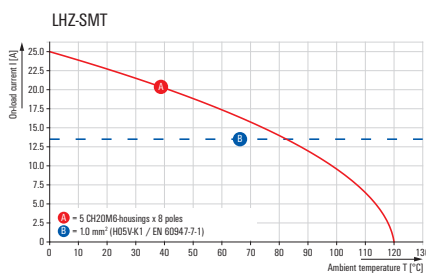

Note: Rated data according to UL - refer to the online data sheet



**Circuit board positions in CH20M**

Housing width (mm)	12.5	17.5	22.5	45.0	67.5
Number of circuit boards	1	1	1	2	3
Positions per circuit board	1	2	2	4	4



**Dimensional sketch**

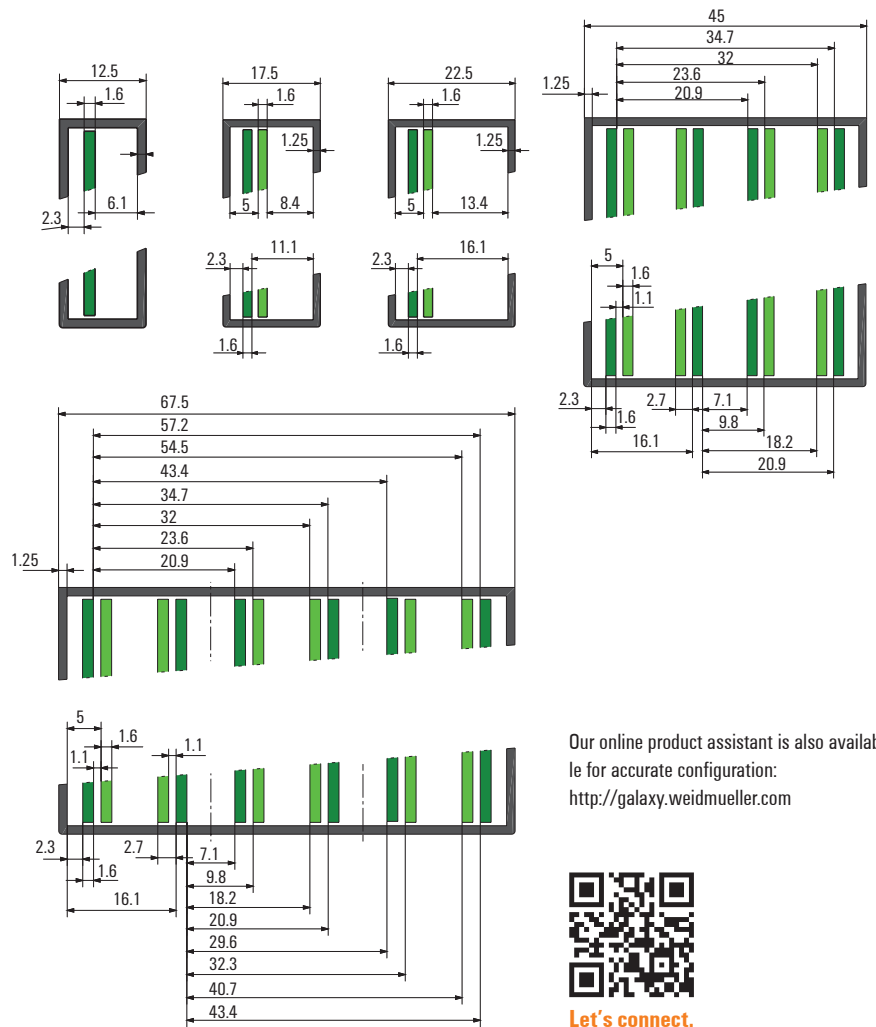

Our online product assistant is also available for accurate configuration:  
<http://galaxy.weidmueller.com>



Let's connect.

**Features of the BHZ/SHL connector system**

- Clamping yoke screw connection – with "WireReady", wire guard protection and plus/minus screw
- Integrated, captive coding (with "AutoSet" function) protects against accidental mismatch
- Leading contact on the male headers
- Finger-safety provided for both, male and female connector



Coding can be set with one of 16 possible configurations

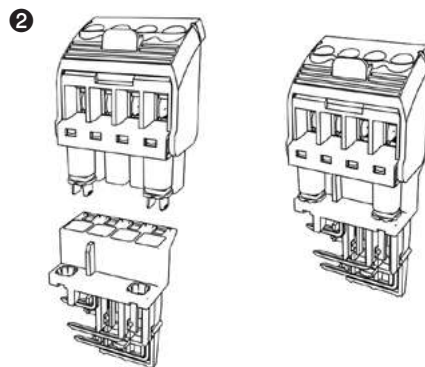

Connecting the female connector

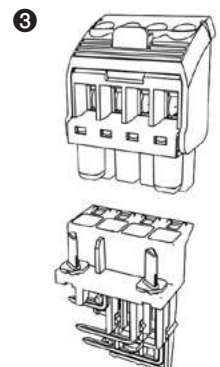

Male header coding transferred to module

SHL-SMT

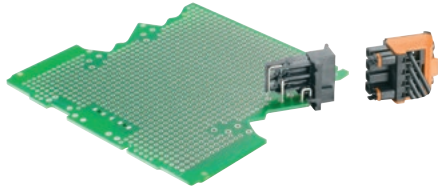

THR male header for modular housing CH20M12-67  
Can be reflow soldered, resistant to high temperatures  
The position of the PCB (see also dimensional sketch) is determined through the configuration of the pin headers  
Suffix 1.5: PCB position 5,0 mm / pin length 1,5 mm (Reflow)  
Suffix 4.2: PCB position 2,3 mm / pin length 1,5 mm (Reflow)  
Suffix 5.9: PCB position 2,3 mm / pin length 3,2 mm (Wave)

Technical data

Insulating material	LCP
Flammability rating (UL 94)	VO
Rated voltage	250 V
Rated current	10 A

SHL-SMT 5.00/GL BX



Left-sided pin header  
Box packaging

Ordering data

Type / Version	Poles	Qty.	Order No.
SHL-SMT 5.00/02GL 4.2BX	2	156	1069620000
SHL-SMT 5.00/02GL 5.9BX	2	156	1069750000
SHL-SMT 5.00/03GL 1.5BX	3	120	1063210000
SHL-SMT 5.00/03GL 4.2BX	3	120	1069630000
SHL-SMT 5.00/03GL 5.9BX	3	120	1069760000
SHL-SMT 5.00/04GL 1.5BX	4	120	1063220000
SHL-SMT 5.00/04GL 4.2BX	4	120	1069640000
SHL-SMT 5.00/04GL 5.9BX	4	120	1069770000

Dimensional drawing

Version left  
2-pole

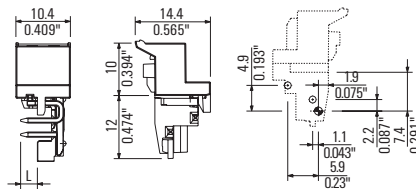

3-pole

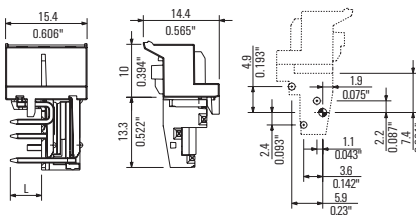

SHL-SMT 5.00GL RL



Left-sided pin header  
Tape-on-reel

Ordering data

Type / Version	Poles	Qty.	Order No.
SHL-SMT 5.00/02GL 4.2RL	2	260	1069650000
SHL-SMT 5.00/02GL 5.9RL	2	260	1069780000
SHL-SMT 5.00/03GL 1.5RL	3	175	1063240000
SHL-SMT 5.00/03GL 4.2RL	3	175	1069660000
SHL-SMT 5.00/03GL 5.9RL	3	175	1069790000
SHL-SMT 5.00/04GL 1.5RL	4	130	1063250000
SHL-SMT 5.00/04GL 4.2RL	4	130	1069670000
SHL-SMT 5.00/04GL 5.9RL	4	130	1069810000

Dimensional drawing

Version right  
2-pole

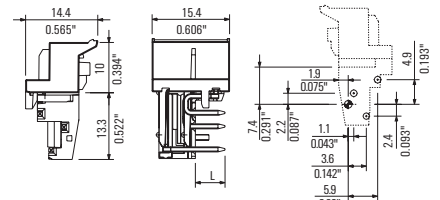

3-pole

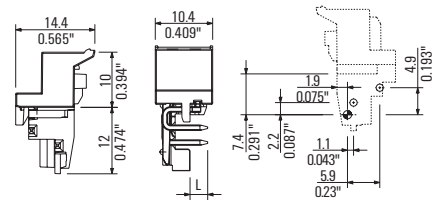

Rated data when used together with BHZxx female plug; refer to page N.32

**SHL-SMT 5.00/GR BX**



Version right  
Box packaging

**SHL-SMT 5.00GR RL**



Version right  
Tape-on-reel

**Ordering data**

Type / Version	Poles	Qty.	Order No.
SHL-SMT 5.00/02GR 4.2BX	2	156	<b>1069550000</b>
SHL-SMT 5.00/02GR 5.9BX	2	156	<b>1069680000</b>
SHL-SMT 5.00/03GR 1.5BX	3	120	<b>1063140000</b>
SHL-SMT 5.00/03GR 4.2BX	3	120	<b>1069560000</b>
SHL-SMT 5.00/03GR 5.9BX	3	120	<b>1069690000</b>
SHL-SMT 5.00/04GR 1.5BX	4	120	<b>1063150000</b>
SHL-SMT 5.00/04GR 4.2BX	4	120	<b>1069570000</b>
SHL-SMT 5.00/04GR 5.9BX	4	120	<b>1069710000</b>

**Dimensional drawing**

Version left  
4-pole

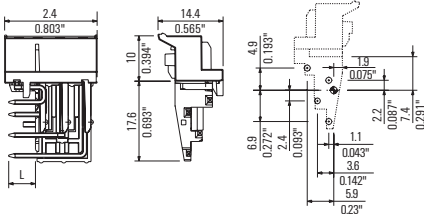

**Ordering data**

Type / Version	Poles	Qty.	Order No.
SHL-SMT 5.00/02GR 4.2RL	2	260	<b>1069580000</b>
SHL-SMT 5.00/02GR 5.9RL	2	260	<b>1069720000</b>
SHL-SMT 5.00/03GR 1.5RL	3	175	<b>1063170000</b>
SHL-SMT 5.00/03GR 4.2RL	3	175	<b>1069590000</b>
SHL-SMT 5.00/03GR 5.9RL	3	175	<b>1069730000</b>
SHL-SMT 5.00/04GR 1.5RL	4	130	<b>1063180000</b>
SHL-SMT 5.00/04GR 4.2RL	4	130	<b>1069610000</b>
SHL-SMT 5.00/04GR 5.9RL	4	130	<b>1069740000</b>

**Dimensional drawing**

Version right  
4-pole

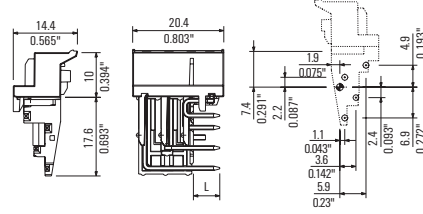

BHZ

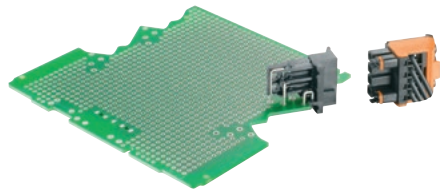

Female plug for modular housing CH20M12-67  
5.00 mm, clamping-yoke connection, integrated coding, release lever can be colour coded

BHZ 5.00/90 BK/OR



Release lever, orange

Technical data

Insulating material	PA
Flammability rating (UL 94)	V0
Rated voltage	250 V
Rated current	10 A

Conductors that can be connected

Clamping range	0.13 mm <sup>2</sup> - 3.31 mm <sup>2</sup>
Wire cross-section, AWG, min	AWG 26 - AWG 12
Solid, min. H05(07) V-U	0.2 mm <sup>2</sup> - 2.5 mm <sup>2</sup>
Flexible, min. H05(07) V-K	0.2 mm <sup>2</sup> - 2.5 mm <sup>2</sup>
With wire end ferrule, acc. to DIN 46 228/1, max.	0.2 mm <sup>2</sup> - 2.5 mm <sup>2</sup>
With wire-end ferrule with DIN 46 228/4, min.	0.2 mm <sup>2</sup> - 2.5 mm <sup>2</sup>

Rated data according to DIN IEC

Rated current, Max. pole count (Tu=20 °C)	10 A
Rated current, Max. pole count (Tu=40 °C)	9 A
Rated voltage for surge voltage class / contamination degree III/3	250 V
Rated impulse voltage for surge voltage class / contamination degree III/3	4 kV
Rated impulse voltage for surge voltage class / contamination degree III/2	4 kV
Rated voltage for surge voltage class / contamination degree III/2	320 V
Rated voltage for surge voltage class / contamination degree II/2	400 V
Rated impulse voltage for surge voltage class / contamination degree II/2	4 kV

Dimensional drawing

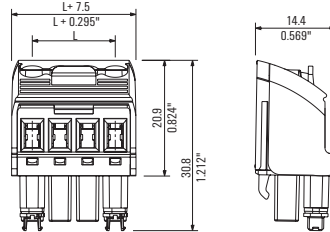

Ordering data

Type / Version	Poles	Qty.	Order No.
BHZ 5.00/02/90LH BK/OR	2	150	1063260000
BHZ 5.00/03/90LH BK/OR	3	180	1063270000
BHZ 5.00/04/90LH BK/OR	4	78	1063280000

Derating curve

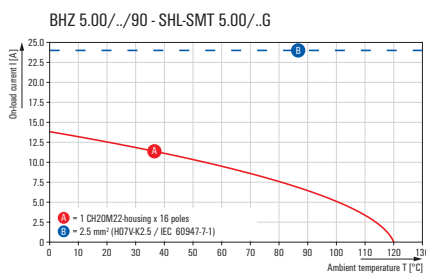
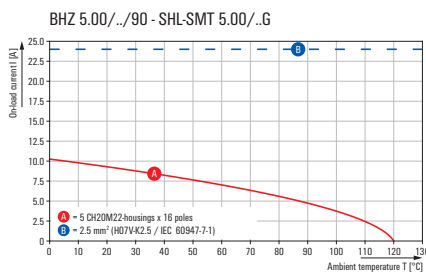

Note: Rated data according to UL - refer to the online data sheet

**BHZ 5.00/90 BK/BK**



Release lever, black

**BHZ 5.00/90 BK/BL**



Release lever, blue

**Accessories**

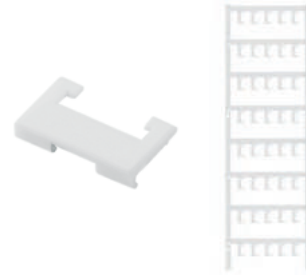

Marker for release lever

**Ordering data**

Type / Version	Poles	Qty.	Order No.
BHZ 5.00/02/90LH BK/BK	2	150	1069330000
BHZ 5.00/03/90LH BK/BK	3	108	1069340000
BHZ 5.00/04/90LH BK/BK	4	78	1069350000

**Ordering data**

Type / Version	Poles	Qty.	Order No.
BHZ 5.00/02/90LH BK/BL	2	150	1069360000
BHZ 5.00/03/90LH BK/BL	3	108	1069370000
BHZ 5.00/04/90LH BK/BL	4	78	1069380000

**Ordering data**

Type / Version	Poles	Qty.	Order No.
ESG 6.6/11 BHZ 5.00/02	2	200	1082490000
ESG 6.6/15 BHZ 5.00/03	3	200	1082520000
ESG 6.6/20 BHZ 5.00/04	4	200	1082540000

SR-SMD

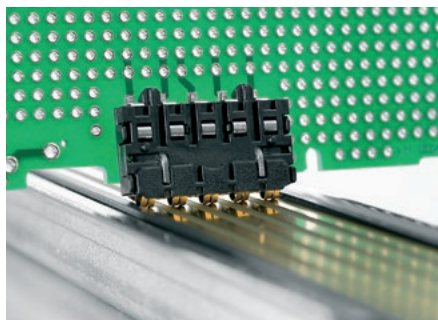

Bus contact block  
Reflow-compatible, resistant to high temperatures,  
5-pole, for rail bus

Technical data

Insulating material	LCP
Flammability rating (UL 94)	V0
Rated voltage IEC	63 V AC
Rated current IEC CH20M6	2 A (at 70 °C)
Rated current IEC CH20M22	4 A (at 70 °C)
Rated voltage UL	150 V
Rated current UL	5 A

Derating curve

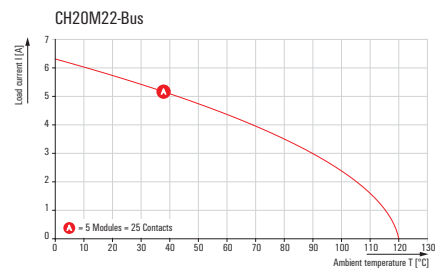
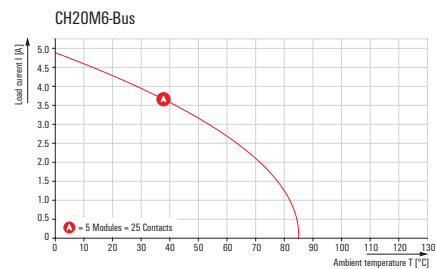

Note: Framework conditions of rating data available on request

SR-SMD

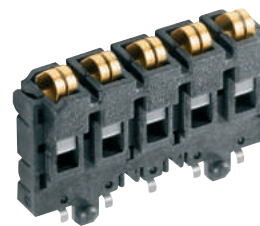

Bus contact for CH20M6

Dimensional drawing

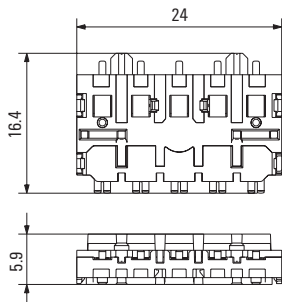

For CH20M6

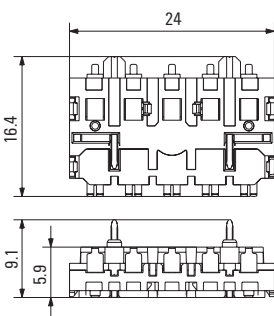

With centre solder flange for CH20M12-67

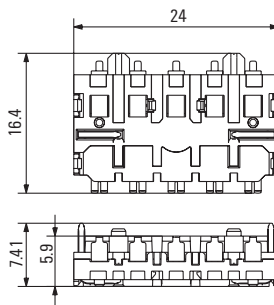

With solder flange for CH20M12-67

Ordering data

Type / Version	Qty.	Order No.
SR-SMD 4.50/05/90 AU BK BX	72	1155840000
SR-SMD 4.50/05/90 AU BK RL	300	1155850000

"BX" means box packaging, "RL" means tape-on-reel

SR-SMD

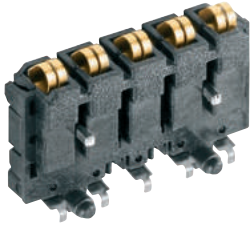

Bus contact with centre solder flange for CH20M12-67

Ordering data

Type / Version	Qty.	Order No.
SR-SMD 4.50/05/90LFM AU BK BX	72	1155870000
SR-SMD 4.50/05/90LFM 3.2AU BK RL	300	1155880000

SR-SMD

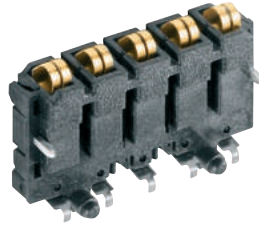

Bus contact with solder flange for CH20M12-67

Ordering data

Type / Version	Qty.	Order No.
SR-SMD 4.50/05/90LF AU BK BX	72	1155890000
SR-SMD 4.50/05/90LF 1.5AU BK RL	300	1155900000

CH20M FE 12-67

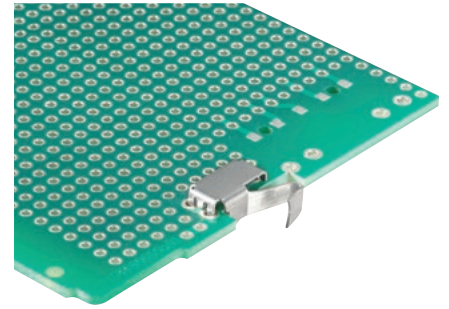

FE contact for CH20M 12-67

Ordering data

Type / Version	Qty.	Order No.
CH20M FE 12-67 1.5SN RL	750	1189370000
CH20M FE 12-67 3.2SN RL	750	1264240000

"BX" means box packaging, "RL" means tape-on-reel

"BX" means box packaging, "RL" means tape-on-reel

**CH20M BUS-PROFIL TS35x7.5/1000**

Support section for bus circuit board



- Support section for TS 35 x 7.5
- Length: 250, 500 or 750 mm

**Ordering data**

Type	Qty.	Order No.
CH20M BUS-PROFIL TS35x7.5/250	10	1248150000
CH20M BUS-PROFIL TS35x7.5/500	10	1248160000
CH20M BUS-PROFIL TS35x7.5/750	5	1248170000

**Note:** Length specification /XXX = 250, 500 or 750 mm. Other lengths available on request.

**CH20M BUS-PROFIL TS35x15/1000**

Support section for bus circuit board



- Support section for TS 35 x 15
- Length: 250, 500 or 750 mm

**Ordering data**

Type	Qty.	Order No.
CH20M BUS-PROFIL TS35x15/250	5	1248180000
CH20M BUS-PROFIL TS35x15/500	5	1248190000
CH20M BUS-PROFIL TS35x15/750	5	1248210000

**Note:** Length specification /XXX = 250, 500 or 750 mm. Other lengths available on request.

**CH20M BUS 4.50/05 AU/1000**

Bus PCB



- Bus circuit board for use on TS 35 x 7.5 and TS 35 x 15
- Length: 250, 500 or 750 mm
- Five conductor paths, gold-plated
- Electrical rating: 63 V AC, 5 A/conductor path

**Ordering data**

Type	Qty.	Order No.
CH20M BUS 4.50/05 AU/250	10	1248220000
CH20M BUS 4.50/05 AU/500	10	1248230000
CH20M BUS 4.50/05 AU/750	5	1248240000

**Note:** Length specification /XXX = 250, 500 or 750 mm. Other lengths available on request.

**CH20M BUS-ADP TS35/1000**

Cover plate



- Cover plate for DIN rail bus
- Length: 250, 500 or 750 mm

**Ordering data**

Type	Qty.	Order No.
CH20M BUS-ADP TS35/250	10	1248250000
CH20M BUS-ADP TS35/500	10	1248260000
CH20M BUS-ADP TS35/750	5	1248270000

**Note:** Length specification /XXX = 250, 500 or 750 mm. Other lengths available on request.

**CH20M BUS-AP LI TS35x7.5 & 15**

End plate



- End plate for DIN rail bus
- Fits on TS 35 x 7.5 and TS 35 x 15
- left

**Ordering data**

Type	Qty.	Order No.
CH20M BUS-AP LI TS35x7.5 & 15	50	1193160000

**CH20M BUS-AP RE TS35x7.5 & 15**

End plate



- End plate for DIN rail bus
- Fits on TS 35 x 7.5 and TS 35 x 15
- right

**Ordering data**

Type	Qty.	Order No.
CH20M BUS-AP RE TS35x7.5 & 15	50	1193170000



**SET CH20M BUS 250MM TS 35X15**

Set



- SET consists of one each of  
 CH20M BUS 4.50/05 AU/250  
 CH20M BUS-ADP TS 35/250  
 CH20M BUS-AP LI TS 35X7.5 & 15  
 CH20M BUS-AP RE TS 35X7.5 & 15  
 CH20M BUS-PROFIL TS 35X15/250

**Ordering data**

Type	Qty.	Order No.
SET CH20M BUS 250MM TS 35X15	1	1335150000

**SET CH20M BUS 250MM TS 35X7.5**

Set



- SET consists of one each of  
 CH20M BUS 4.50/05 AU/250  
 CH20M BUS-ADP TS 35/250  
 CH20M BUS-AP LI TS 35X7.5 & 15  
 CH20M BUS-AP RE TS 35X7.5 & 15  
 CH20M BUS-PROFIL TS 35X7.5/250

**Ordering data**

Type	Qty.	Order No.
SET CH20M BUS 250MM TS 35X7.5	1	1335140000

**TS 35x7.5 / TS 35x15**

Mounting rail

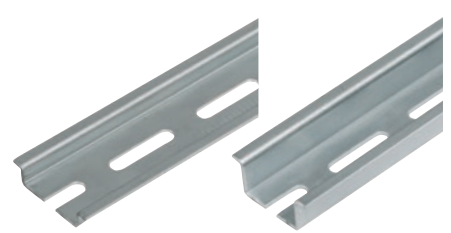

- Mounting rail with slot
- Steel, galvanised and passivated

**Ordering data**

Type	Qty.	Order No.
TS 35X7.5/LL 1M/ST/ZN	10	0514510000
TS 35X15/LL 1M/ST/ZN	10	0236510000

# OMNIMATE® Housing MICROBOX / TERMINALBOX

The MICROBOX and TERMINALBOX series of small housings are the perfect solution for miniature sliced applications or for the protective circuitry used in connection with terminal blocks.

Up to 6 wires can be connected using the integrated (but high-performance) clamping-yoke screw or tension-clamp wire connection mechanisms.

Because of its closed construction, each individual MICROBOX is finger-safe. The TERMINALBOX can be aligned side-by-side without end or closed off using an end plate.

Pluggable cross-connectors from our terminal block line allow simple, safe power distribution of up to 32 A.

### Secure contacts

The TERMINALBOX MCZ 1.5 can optionally be equipped with a contact element that automatically establishes contact with the rail when the housing is snapped on.

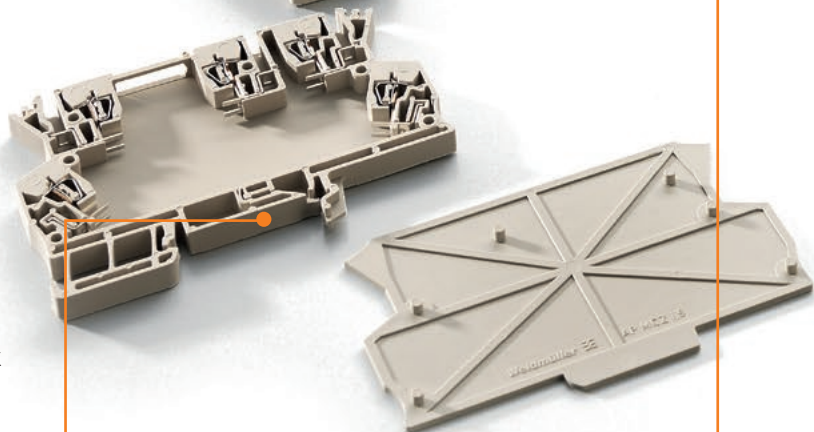
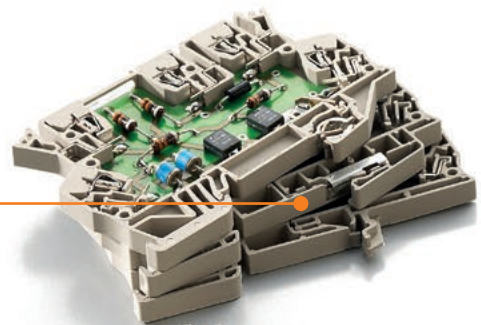
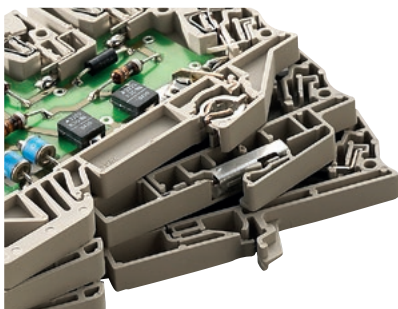

### Compact integration

With a width of only 6.00 mm, the TERMINALBOX MCZ 1.5 provides enough space for a miniature circuit board and 5 tension clamp connection for wires up to 1.5 mm<sup>2</sup>.

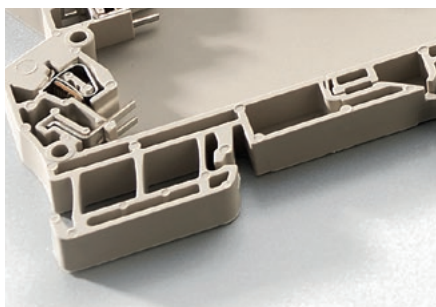

### Seamlessly connected

High-power cross-connectors allow power (up to 32 A) to be easily and quickly distributed on up to three levels.



**Easy to operate**

The transparent hinged covers make adjustments simple (for example, using DIP switches). Labelling is also possible.

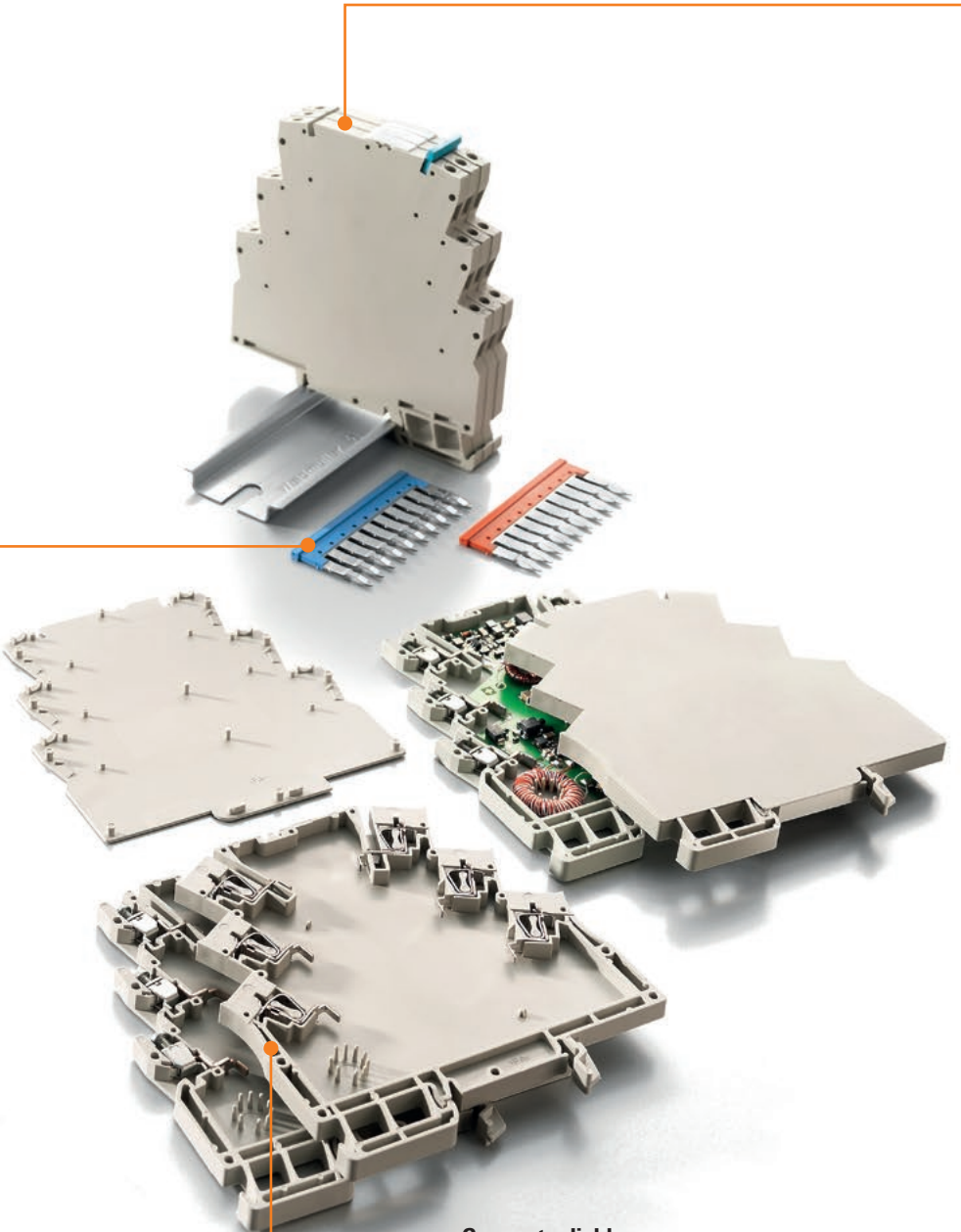

**Connect reliably**

The MICROBOX provides a permanent, secure clamp connection for 6 wires up to 2.5 mm<sup>2</sup> (MHS 6 with clamping yoke screw connection) or up to 1.5 mm<sup>2</sup> (MHZ 6 with tension-clamp spring connection).

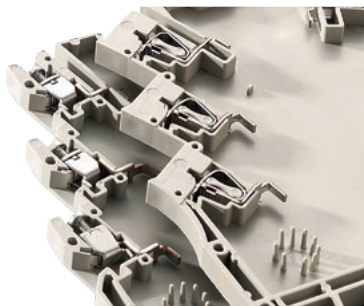

**MICROBOX MHS 6**

Miniature sliced-section housing in 6.1 mm width A total of 6 clamping yoke screw connections (for 2.5 mm<sup>2</sup> wires) can be manually or selectively wave soldered.

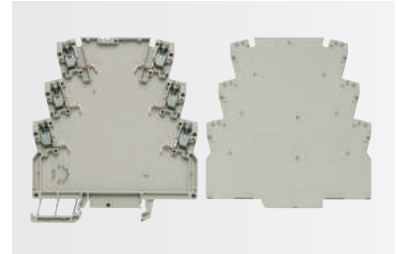

**MICROBOX MHZ 6**

Miniature sliced-section housing in 6.1 mm width A total of 6 tension clamp connection (for 1.5 mm<sup>2</sup> wires) can be manually or selectively wave soldered.

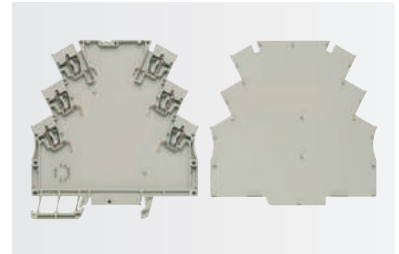

**TERMINALBOX MCZ 1.5**

Terminal-block-format open housings with tension clamp connection for wires up to 1.5 mm<sup>2</sup>. A total of 5 connection elements can be manually or selectively wave soldered.

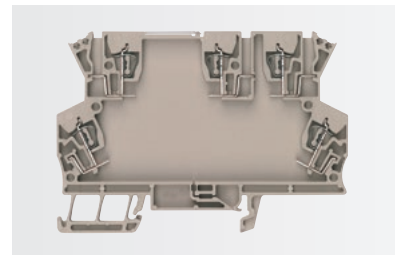



### MCZ 1.5

The transparent hinged top plate is used for labelling and calibration. Maximum equipment level requires 2 short and 3 long current bars. The space available and the number of connections can be doubled using the frame. CAD drawings that ease the production of layouts and equipping of boards (details of blocked area, max. component heights, pads, etc.), are available on request. The MCZ housing kit consists of:

- 1 terminal holder
- 1 top plate
- 1-5 current bars with tension clamp
- 1 end plate (if required)

### Technical data

General data	
Dimensions W x L x H (w. TS 35 x 7.5)	mm
No. of connections	total
Access for calibration	
Shielding	
Contact to the mounting rail	
Number of PCB per module	
PCB-connection	
Thickness of PCB	
Ingress protection class	
Tightening torque range	
Stripping length	
Pollution severity	
Material	
Flammability class UL 94	
Colour of insulating material	
Clampable conductors (H05V/H07V)	
Solid	mm <sup>2</sup>
Flexible	mm <sup>2</sup>
Max. conductor AWG	
Plug gauge to 60947-1	
Note	

### Ordering data

Individual parts	
<b>For mounting rail TS 35</b>	with connection element for connection element for mounting rail contact, for connection element
<b>For mounting rail TS 32</b>	with connection element
<b>Frame for TS 35</b>	
<b>Frame for TS 35</b>	for connection element
<b>Frame for TS 32</b>	
<b>Top part</b>	open closed
<b>Current bars (w. tension clamp)</b>	short version long version
<b>Current bars</b>	horizontal vertical
<b>Clamp, yoke unit</b>	clamp, yoke + screw
<b>Screw</b>	
<b>Clamping yoke</b>	
<b>Mounting rail contact</b>	
Housing cover	
Note	

### Accessories

End plate	
Cross-connection	
Note	

### MCZ 1.5

#### Tension clamp connection

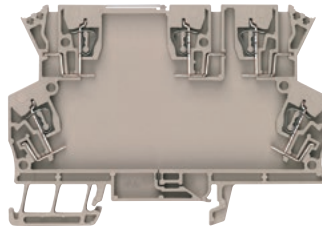

6 / 91.3 / 63.5	
5	
Movable top plate	
not available	
Earthing-contact	
1	
soldered connection, directly	
1.0 (+ 0.2) mm	
IP 20	
6 mm	
3	
PA	
VO	
beige/black	
Screw connection	Tension clamp connection
	0.2...1.5
	0.2...1.5
	AWG 26...AWG 16
Note	

Type	Qty.	Order No.
MCZ 5	10	8857560000
GH MCZ1.5	1	2224220000
GH MCZUE1.5/UE	1	2312290000
RA MCZ1.5	25	2224240000
KOPL MCZ1.5	18	2224040000
SMSE KU FE MCZ 1.5	1	2224390000
SMSE LN FE MCZ 1.5	1	2224380000
SMSE FE MCZ 1.5/PE	100	1003280000
Note		

Type	Qty.	Order No.
AP MCZ1.5	50	8389030000
ZQV 4N/2 RT	60	1793950000
ZQV 4N/2 BL	60	1793960000
ZQV 4N/2 GE	60	1758250000
Note		
Full housing available as set on request.		

# OMNIMATE® Housing RS

## Profile housing

### Flexible – more flexible – profile form

Build housing in profile form – the flexible modular system of coloured and transparent PVC profiles and carrier modules the perfect combination of any mounting utilising standard pitches and precisely cut to length, this creates the perfect balance between flexibility and efficiency: The modular approach is ideal for assemblies with high space requirements and is particularly suited for small quantities or variable widths.

#### Flexible covers

See-through covers in various heights protect assemblies even with high components safely.

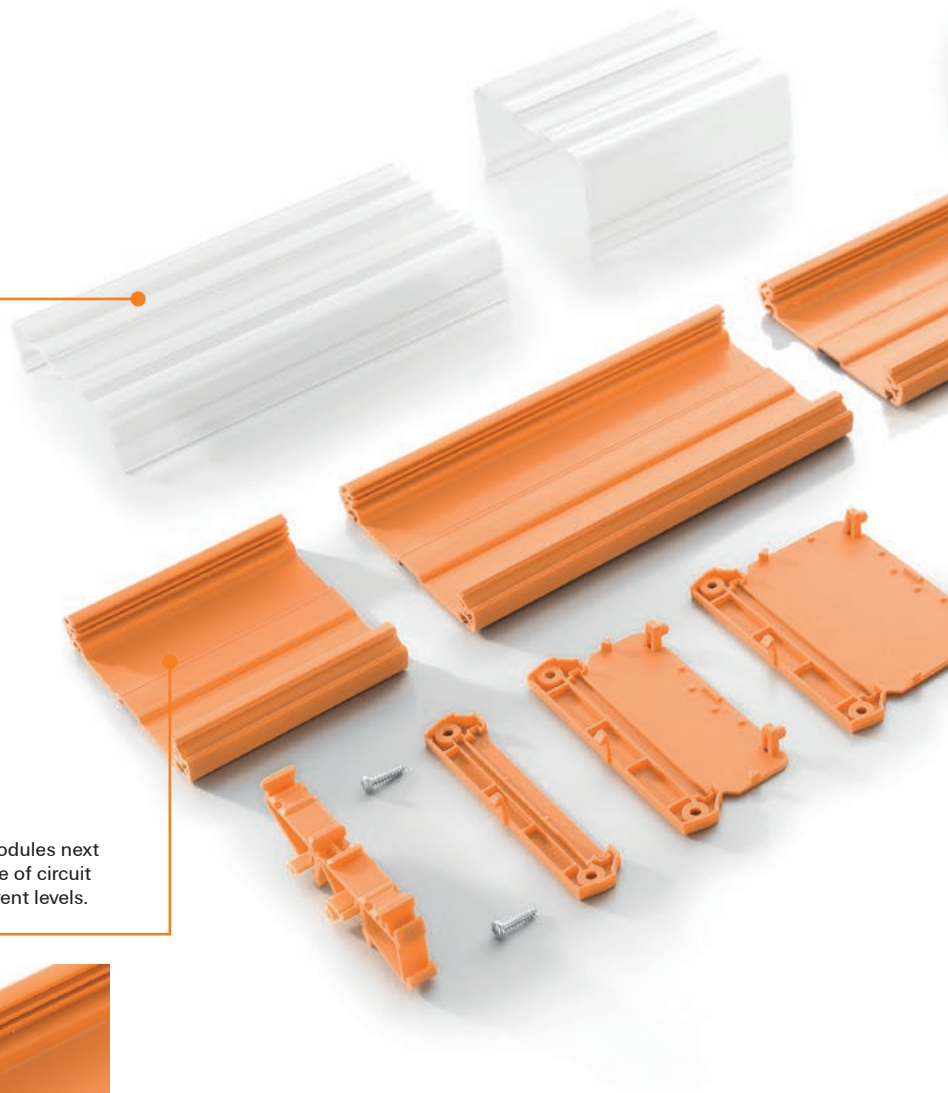

#### Flexible installation

Extruded profiles can take several modules next to each other. Depending on the type of circuit boards can be installed on two different levels.



**Flexible lengths**

Cut, or joined together in a row: extruded profiles can be easily adjusted to the space requirements of every application.

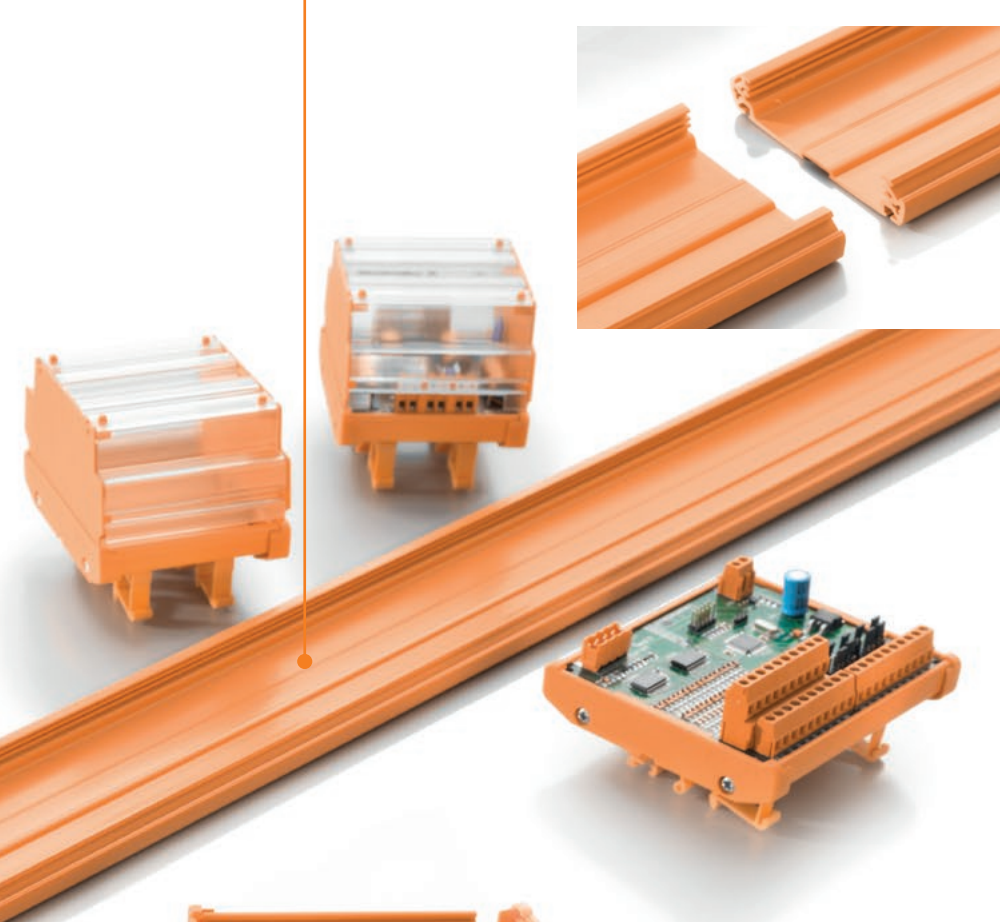

**Variable RS-profile housing**

Variable, precision cut extruded profile with different height cover hoods allow maximum packing density even for large electronic sub-assemblies.

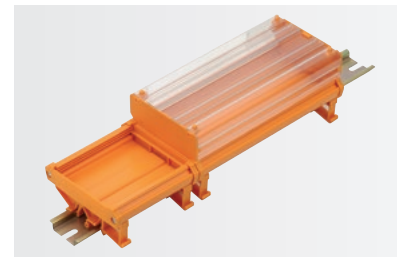

**Modular RS-profile housing**

Tool-free latching profiles with standard widths from 5 to 45 mm allow rapid assembly of tailor made solutions.



**Flexible mounting**

Mounting options: snapped onto the mounting rail or directly secured using screws.





N

# OMNIMATE® Housing RS

## Profile housing

RS profile housings can be snapped on to DIN rails or mounted directly. They are available in six widths. The extruded profiles can be cut to length or joined together in modules and are ideal for low volume, special assemblies or test set-ups. Fitted transparent hoods are used to protect the components.

Width	Type	Construction/Width of circuit board	Catalogue pages	Colour scale <sup>1)</sup>
45.0 mm	RS 45	Variable / 42.0 mm	N.46	 Similar to RAL 9011
70.0 mm	RS 70	Modular / 67.8 mm	N.47	 Similar to RAL 7024
87.0 mm	RS 80	Variable / 67.8 mm	N.48	 Similar to RAL 2000
86.0 mm	RS 90	Variable / 79.8 mm	N.49	
109.0 mm	RS 100	Variable / 100.0 mm	N.50	
130.8 mm	RS 122	Variable / 122.0 mm	N.51	

**Note 1)** Other colours on request

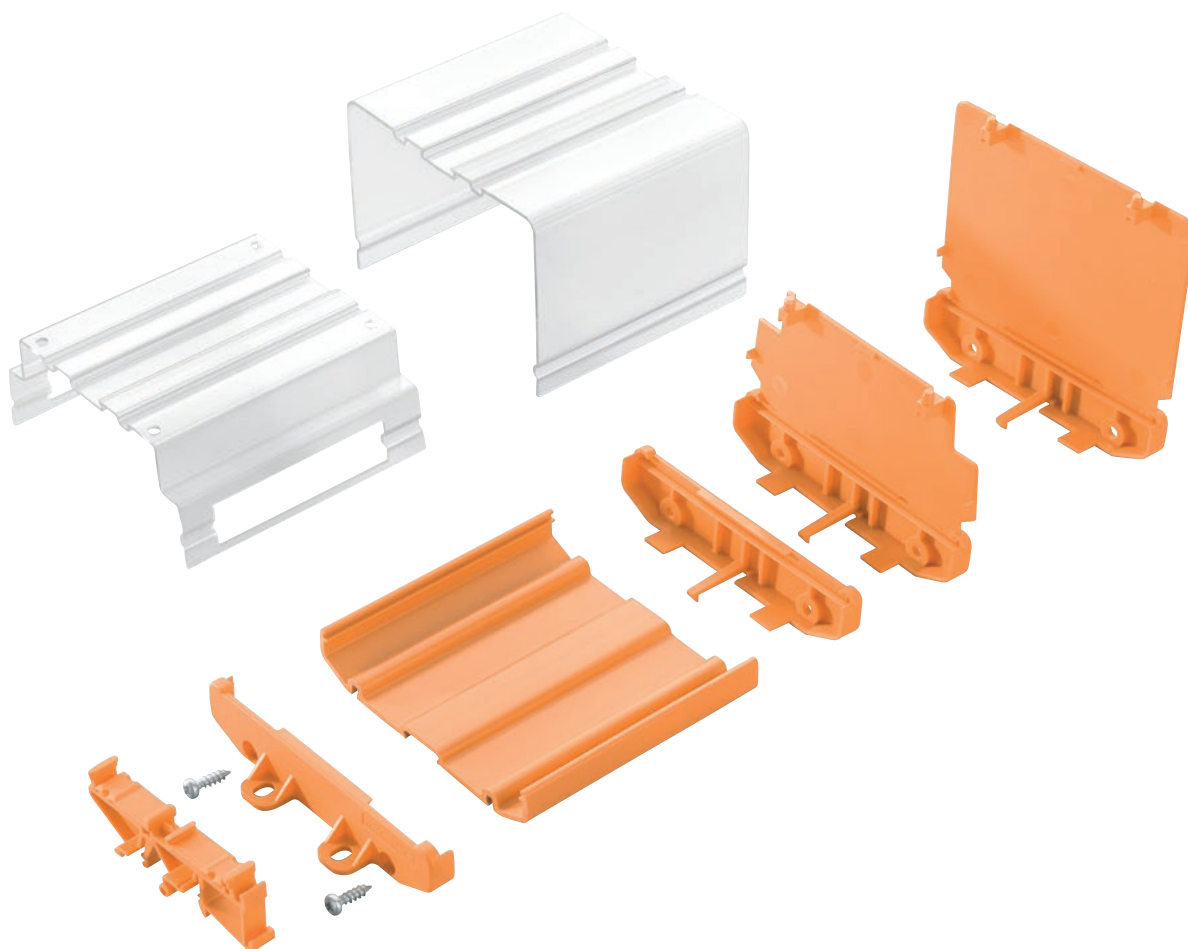



Housing variants

RS 45



Description/Type

RS extruded profile 45 mm, variable

Features:

- Width: 45 mm
- Circuit board width: 42 mm
- Number of circuit boards (max.): 1
- Protection class (max.): IP 00

Design options



- Can be shortened to any length
- Rail mounted
- Direct mount<sup>2)</sup>
- Machinable



RS 70



RS extruded profile 70 mm, modular

Features:

- Width: 70 mm
- Circuit board width: 67.8 mm
- Number of circuit boards (max.): 1
- Protection class (max.): IP 00



- Can be aligned side-by-side without any tools
- Rail mounted

RS 80



RS extruded profile 80 mm, variable

Features:

- Width: 87 mm
- Circuit board width: 67.8 mm
- Number of circuit boards (max.): 1
- Protection class (max.): IP 20
- Markable



- Can be shortened to any length
- Rail mounted
- Direct mount<sup>2)</sup>
- Transparent hood (opt.)
- Machinable

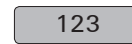

RS 90



RS extruded profile 90 mm, variable

Features:

- Width 86: mm
- Circuit board width: 79.8 mm
- Number of circuit boards (max.): 1
- Protection class (max.): IP 00



- Can be shortened to any length
- Rail mounted
- Direct mount<sup>2)</sup>
- Machinable

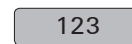

RS 100



RS extruded profile 100 mm, variable

Features:

- Width 109: mm
- Circuit board width: 100 mm
- Number of circuit boards (max.): 1
- Protection class (max.): IP 20



- Can be shortened to any length
- Rail mounted
- Direct mount<sup>2)</sup>
- Transparent hood (opt.)
- Machinable

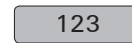

RS 122

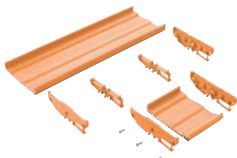

RS extruded profile 122 mm, variable

Features:

- Width: 130.8 mm
- Circuit board width: 122 mm
- Number of circuit boards (max.): 2
- Protection class (max.): IP 00



- Can be shortened to any length
- Rail mounted
- Machinable



pad printing,

123

markable,



can be machine-worked (drilling/milling),

<sup>2)</sup> Screw mount

### RS 45

Depending on the end plate design, the profiles can be mounted directly or on rail

1. The rail-mountable assembly requires:

- 2 end plates for DIN-rail mounting
- 1 extruded profile
- 4 screws

2. Direct-mountable assembly requires:

- 2 end plates for direct mounting
- 1 extruded profile
- 4 screws

### Description

B3 heights are available for cover profile and end plates:

TS-mounting:

TS 32 = 45 mm, TS 35x7.5 = 40.5 mm

Direct mounting: 24 mm

Dimensions of PCB

Thickness: 1.6 (±0.2) mm, width:

42 (+0.5) mm

Size of RS segment = PCB length - 4.5 mm

Size of ADP segment = PCB length - 1 mm

Example:

PCB length 160 mm,

RS = 155.5 mm, ADP = 159 mm

### Dimensioned drawing

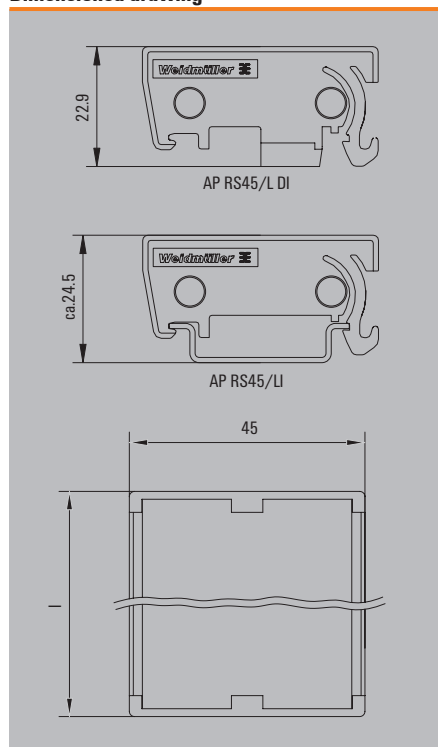

### RS 45



### Technical data

General data	
Number of PCB per module	1
Thickness of PCB	1.6 (± 0.2) mm
Material	PVC/PA
Flammability class UL 94	V2
Colour of insulating material	beige
Note	

### Ordering data

Extruded profile	
2000 mm	orange
2000 mm	grey
1000 mm	grey
155 mm	orange
Intermediate piece	
5 mm	
15 mm	
25 mm	
30 mm	
45 mm	
End plate w. locking foot	
Without cover	grey, left version
	grey, right-hand version
	orange, left version
	orange, right-hand version
Locking foot	
	orange
	grey
With marking facilities	left version
	right version
Without marking facilities	left version
	right version
Central	Intermediate foot

End plate for direct mounting	
Without cover	grey, left version
	grey, right version
	orange
	grey
For medium-high cover profile	orange
	grey
For high cover profile	orange
	grey
End plate for mounting rail installation	
Without cover	orange
	grey
For medium-high cover profile	orange
	grey
For high cover profile	orange
	grey

Cover profile 1000 mm	Medium-high
Screws	high
Note	

1
1.6 (± 0.2) mm
PVC/PA
V2
beige

Type	Qty.	Order No.
RF RS 45 OR 2000	VO 1	4340430000
PF RS 45 GR 2000	VO 1	4027750000
PF RS 45 GR 1000	VO 10	8140880000

AP 45/LI	V2 20	8143910000
AP 45/RE	V2 20	8143900000
AP 45/LI OR	V2 20	1011590000
AP 45/RE OR	V2 20	1011600000

AP 45/LI DI	V2 20	8140870000
AP 45/RE DI	V2 20	8140860000

ADP 1/HP1 1M	V2 1	0485200000
LKSC M2.9x13VZ	100	4011200000

Other lengths on request.		
---------------------------	--	--

## RS 70

Chassis Form:

Rail-mounted version

- 1 clip-on foot left
- 1 clip-on foot right
- 1 or more intermediate pieces
- 1 clip-on foot centre if required

### Description

Height: TS 32 = 33.5 mm, TS 35x7.5 = 29 mm

Dimensions of PCB:

Thickness: 1.6 (± 0.2) mm

Length: 67.8 (- 0.2) mm

Width of intermediate piece = PCB width - 2x9 mm (snap-on feet)

Example:

PCB width = 68 mm

Width of intermediate piece = 50 mm

Intermediate piece 2x ZW 25 RS or

ZW 45 RS + ZW 5 RS

### Dimensioned drawing

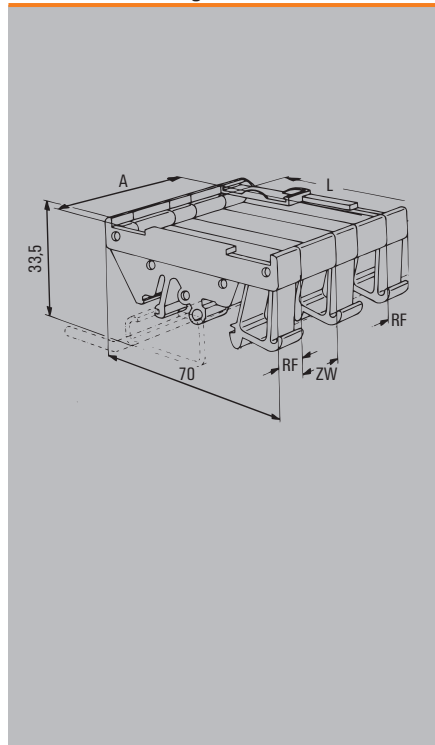

### Technical data

#### General data

Number of PCB per module	
Thickness of PCB	
Material	
Flammability class UL 94	
Colour of insulating material	

#### Note

### Ordering data

#### Extruded profile

2000 mm	orange
2000 mm	grey
1000 mm	grey
155 mm	orange

#### Intermediate piece

5 mm	
15 mm	
25 mm	
30 mm	
45 mm	

#### End plate w. locking foot

Without cover	grey, left version
	grey, right version

#### Locking foot

	orange
	grey
With marking facilities	left version
	right version
Without marking facilities	left version
	right version
Central	Intermediate foot

#### End plate for direct mounting

Without cover	grey, left version
	grey, right version
	orange
	grey
For medium-high cover profile	orange
	grey
For high cover profile	orange
	grey

#### End plate for mounting rail installation

Without cover	orange
	grey
For medium-high cover profile	orange
	grey
For high cover profile	orange
	grey

Cover profile	Medium-high
	high

Screws

#### Note

## RS 70



1
1.6 (± 0.2) mm
PA
V2
orange

Type	Qty.	Order No.
ZW 5 RS OR	20	0119760000
ZW 15 RS OR	20	0119860000
ZW 25 RS OR	20	0126160000
ZW 30 RS OR	20	0119960000
ZW 45 RS OR	20	0120060000
RF RS 70 RE/A3/M.BEZ	20	0119560000
RF RS 70 LI/A2/O.SG	20	0119660000
RF RS 70 RE/A4/O.BEZ	20	0126260000
RF RS 70 MI/A6	20	0213760000

**RS 80**

Housing installation (plus 4 screws):  
 Rail mounted variant (rail mounted assembly)

- 2 end plates for rail mounted assembly
- 2 or more locking feet
- 1 extruded profile
- 1 cover profile (optional)

Direct mounting variant

- 2 end plates, direct mounting
- 1 extruded profile
- 1 cover profile (optional)

**Description**

3 heights are available for cover profile and end plates:

Rail mounting without cover:

TS 32 = 45 mm, TS 35x7.5 = 40.5 mm

Rail mounting with low cover:

TS 32 = 72 mm, TS 35x7.5 = 67.5 mm

Rail mounting with high cover:

TS 32 = 91 mm, TS 35x7.5 = 86.5 mm

Direct mounting without/low/high cover:

17 / 44 / 63 mm

Dimensions of PCB

Thickness: 1.6 (±0.2) mm, width:

67.8 (+0.2) mm

Size of RS segment = PCB length - 4.5 mm

Size of ADP segment = PCB length - 2 mm

Example:

PCB length 160 mm

RS = 155.5 mm, ADP = 158 mm

**Dimensioned drawing**

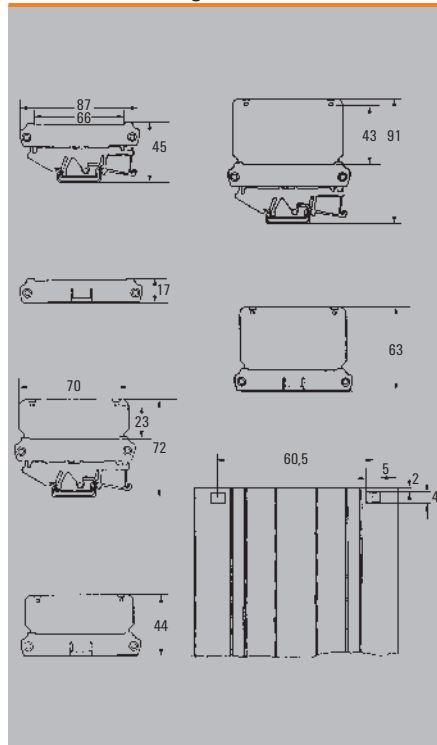

N

**Technical data**

General data	
Number of PCB per module	
Thickness of PCB	
Material	
Flammability class UL 94	
Colour of insulating material	
Note	

**Ordering data**

Extruded profile	
2000 mm	orange
2000 mm	grey
1000 mm	grey
155 mm	orange

Intermediate piece	
5 mm	
15 mm	
25 mm	
30 mm	
45 mm	

End plate w. locking foot	
Without cover	grey, left version grey, right version

Locking foot	
	orange grey
With marking facilities	left version right version
Without marking facilities	left version right version
Central	intermediate foot

End plate for direct mounting	
Without cover	grey, left version grey, right version

For medium-high cover profile	orange grey
For high cover profile	orange grey

End plate for mounting rail installation	
Without cover	orange grey
For medium-high cover profile	orange grey
For high cover profile	orange grey

Cover profile 1000 mm	Medium-high
1000 mm	high
Screws	

**Note**

**RS 80**

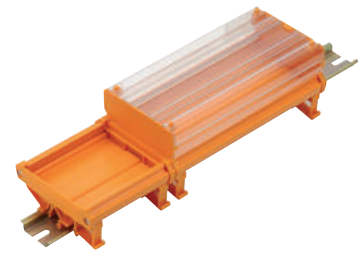

	1
	1.6 (± 0.2) mm
	PVC/PA
	VO
	orange

Type	Qty.	Order No.
PF RS 80 OR 2000MM	VO 1	4157440000
PF RS 80 GR 2000MM	VO 1	4183130000

AP RF80 LI	V2 20	8156210000
AP RF80 RE	V2 20	8156200000
RF 180	20	1324460000
RF 180 GR	V2 20	1773400000

AP 80 D	V2 20	1324360000
AP 85 D	V2 20	1411060000
AP 86 D	V2 20	1411160000

AP 80	V2 20	1324260000
AP 80	V2 20	8320300000
AP 85	V2 20	1410860000
AP 86	20	1410960000

ADP 5	V2 1	4167150000
ADP 6	V2 1	4167160000
LKSC M2.9x13VZ	100	4011200000

Other lengths on request.

## RS 90

Housing installation (plus 4 screws):

- 2 end plates
- 2 or more locking feet
- 1 extruded profile

### Description

Dimensions of PCB

Thickness: 1.6 (±0.2) mm, width: 79.8 (+0.2) mm

Size of RS segment = PCB length - 4.5 mm

Example:

PCB length 160 mm

RS = 155.5 mm

### Dimensioned drawing

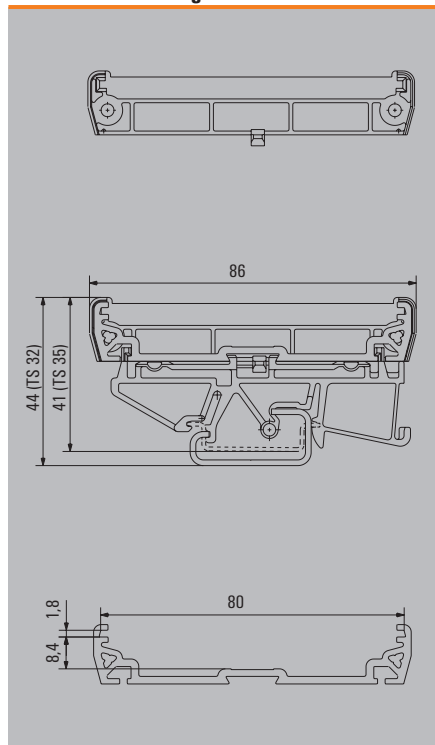

### Technical data

#### General data

Number of PCB per module  
Thickness of PCB  
Material  
Flammability class UL 94  
Colour of insulating material

#### Note

### Ordering data

#### Extruded profile

2000 mm	orange
2000 mm	grey
1000 mm	grey
155 mm	orange

#### Intermediate piece

5 mm  
15 mm  
25 mm  
30 mm  
45 mm

#### End plate w. locking foot

Without cover  
grey, left version  
grey, right version

#### Locking foot

orange  
grey  
With marking facilities  
left version  
right version  
Without marking facilities  
left version  
right version  
Central  
intermediate foot

#### End plate for direct mounting

Without cover  
grey, left version  
grey, right version  
orange  
grey  
For medium-high cover profile  
orange  
grey  
For high cover profile  
orange  
grey

#### End plate for mounting rail installation

Without cover  
orange  
grey  
For medium-high cover profile  
orange  
grey  
For high cover profile  
orange  
grey  
Cover profile  
Medium-high  
high

#### Screws

LKSC M2.9x13VZ 100

#### Note

## RS 90



1
1.6 (± 0.2) mm
PVC/PA
VO
orange

Type		Qty.	Order No.
PF RS 90 OR 2000MM	VO	1	4053240000
PF RS 90 GR 2000MM	VO	1	4051810000

RF 180	V2	20	1324460000
RF 180 GR	V2	20	1773400000

AP 90 OR	V2	20	1961880000
AP 90 GR	V2	20	1961890000

LKSC M2.9x13VZ	100	4011200000
----------------	-----	------------

Other lengths on request.

### RS 100

Housing installation (plus 4 screws):  
 Rail mounted variant (rail mounted assembly)

- 2 end plates for rail mounted assembly
- 2 or more locking feet
- 1 extruded profile
- 1 cover profile (optional)

Direct mounting variant

- 2 end plates, direct mounting
- 1 extruded profile
- 1 cover profile (optional)

### Description

3 heights are available for cover profile and end plates:

Rail mounting without cover:

TS 32 = 45 mm, TS 35x7.5 = 40.5 mm

Rail mounting with low cover:

TS 32 = 89 mm, TS 35x7.5 = 84.5 mm

Rail mounting with high cover:

TS 32 = 121 mm, TS 35x7.5 = 116.5 mm

Direct mounting without/low/high cover:

24 / 69 / 99 mm

Dimensions of PCB

Thickness: 1.6 (±0.2) mm, width:

100 (+0.5) mm

Size of RS segment = PCB length - 4.5 mm

Size of ADP segment = PCB length - 1 mm

Example:

PCB length 160 mm

RS = 155.5 mm, ADP = 159 mm

### Dimensioned drawing

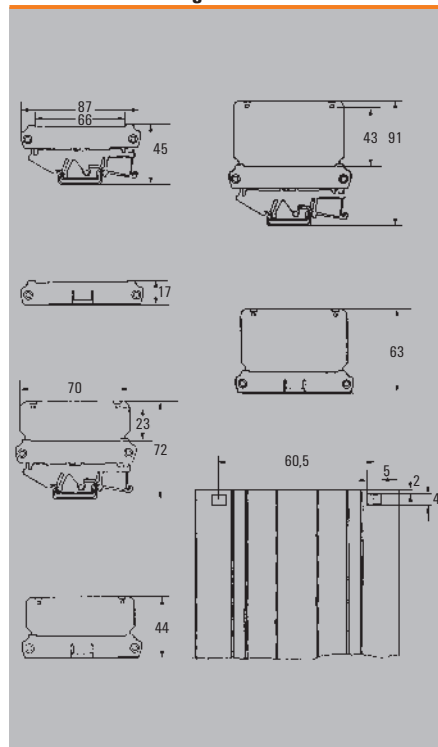

### RS 100

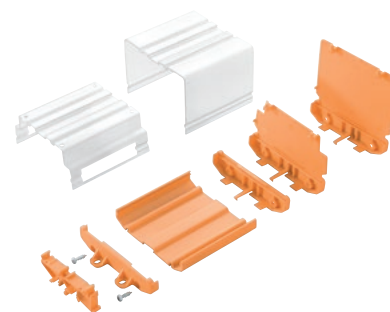

### Technical data

General data	
Number of PCB per module	
Thickness of PCB	
Material	
Flammability class UL 94	
Colour of insulating material	
Note	

### Ordering data

Extruded profile	
2000 mm	orange
2000 mm	grey
1000 mm	grey
155 mm	orange
Intermediate piece	
5 mm	
15 mm	
25 mm	
30 mm	
45 mm	
End plate w. locking foot	
Without cover	grey, left version grey, right version
Locking foot	
	orange grey
With marking facilities	left version right version
Without marking facilities	left version right version
Central	intermediate foot
End plate for direct mounting	
Without cover	grey, left version grey, right version orange grey
For medium-high cover profile	orange grey
For high cover profile	orange grey
End plate for mounting rail installation	
Without cover	orange grey
For medium-high cover profile	orange grey
For high cover profile	orange grey
Cover profile 2000 mm	Medium-high
2000 mm	high
Screws	
Note	

1
1,6 (± 0.2) mm
PVC/PA
VO
orange / grey (Black on request)

Type	Qty.	Order No.
PF RS 100 OR 2000MM A.1 VO	1	4144870000
PF RS 100 GR 2000MM A.1 VO	1	4010870000
PF RS 100 A.1 OR 155.5 VO	25	4148400000
RF 180	V2 20	1324460000
RF 180 GR	V2 20	1773400000
AP 100 D	V2 20	1185160000
AP 110 D	V2 10	1185360000
AP 111 D	V2 10	1185560000
AP 100	V2 20	1185060000
AP 110	V2 10	1185260000
AP 111	V2 10	1185460000
ADP 10	V2 1	4169320000
ADP 11	V2 1	4169330000
PTSC KB40X14	100	4019420000
Other lengths on request.		

### RS 122

Housing construction (plus 4 screws):  
available as a rail mounting version (TS mounting)

- 2 end plates for rail mounted assembly with locking foot
- 2 or more locking feet
- additional intermediate foot
- 1 Extruded profile

### Description

Takes PCB in 2 positions

Dimensions of the PCB

Thickness: 1.6 (±0.2) mm, width: +0.5 mm  
i.e. length RS section = PCB length - 5 mm

Example:

PCB length 160 mm,

RS section = 160 mm - 5 mm = 155 mm

### Dimensioned drawing

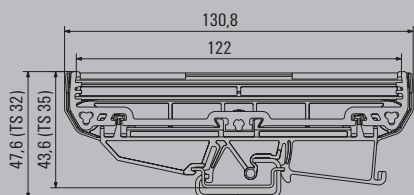

### Technical data

General data	
Number of PCB per module	1
Thickness of PCB	1.6 (± 0.2) mm
Material	PVC/PA
Flammability class UL 94	V0
Colour of insulating material	orange
Note	

### Ordering data

Extruded profile		Type	Qty.	Order No.
2000 mm	orange	PF RS 122 OR 2000MM	10	1155940000
2000 mm	grey			
1000 mm	grey			
155 mm	orange			
Intermediate piece				
5 mm				
15 mm				
25 mm				
30 mm				
45 mm				
End plate w. locking foot				
Without cover	grey, left version			
	grey, right version			
Locking foot				
	orange	RF 108 OR	20	1020690000
	grey			
With marking facilities	left version			
	right version			
Without marking facilities	left version			
	right version			
Central	intermediate foot			
End plate for direct mounting				
Without cover	grey, left version			
	grey, right version			
	orange			
	grey			
For medium-high cover profile	orange			
	grey			
For high cover profile	orange			
	grey			
End plate for mounting rail installation				
Without cover	orange, left version	AP RF 122 LI OR	20	1020640000
	orange, right version	AP RF 122 RE OR	20	1020650000
	grey			
For medium-high cover profile	orange			
	grey			
For high cover profile	orange			
	grey			
Cover profile				
	Medium-high			
	high			
Screws				

Note: Other lengths on request.

**MTA**

Snap-on foot for terminal rail



The MTA 45 mounting adapter enables many different modules to be securely attached to a terminal rail. The adapter, made of fibreglass-reinforced polyamide, ensures high stability and secure fixity to the terminal rail. It is assembled by simply clipping on, and disassembled by pushing up and tilting the module. No tools are required for this.

**Ordering data**

Snap-on foot for TS 35		Black
Type	Qty.	Order No.
MTA 30 BK	45	1168970000
MTA 45 BK	30	1962250000

**MOFU**

Mounting foot

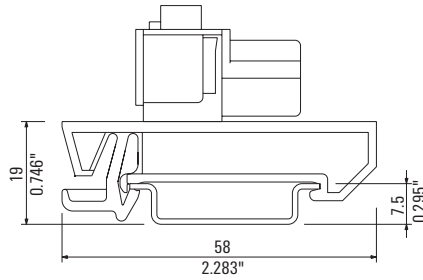
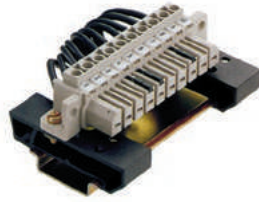

**Ordering data**

Colour		Black
Type	Qty.	Order No.
Mounting foot Mofu	20	0646210000

**WS 10/5**  
**WS 12/5**

MultiCard marking



- WS 10/5 = 10 mm long x 5 mm wide
- WS 12/5 = 12 mm long x 5 mm wide
- Delivered as MultiCard 5 mats with 144 markers

**Ordering data**

Type	Length mm	Order No.
WS 10/5	10	1635000000
WS 12/5	12	1609860000



**SDI**

**VDE-insulated slotted screwdriver**

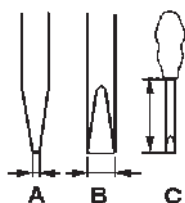

**VDE-insulated slotted screwdriver, SDI**

- DIN 7437, ISO 2380/2
- Output acc. to DIN 5264, ISO 2380/1
- SoftFinish® handle



**Ordering data**

Type	Dims (mm)	A	B	C	Order No.
SDI		0,4	2,5	75	9008370000
SDI		0,5	3,0	100	9008380000
SDI		0,6	3,5	100	9008390000
SDI		0,8	4,0	100	9008400000
SDI		1,0	4,5	125	9008910000
SDI		1,0	5,5	125	9008410000
SDI		1,2	6,5	150	9008420000
SDI		1,6	8,0	175	9008430000

**SD**

**Slotted screwdriver with round blade**

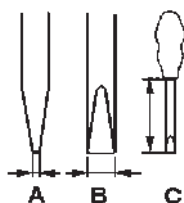

**Slotted screwdriver with round blade, SD**

- DIN 5265, ISO 2380/2
- Output acc. to DIN 5264, ISO 2380/1
- ChromTop tip
- SoftFinish® handle



**Ordering data**

Type	Dims (mm)	A	B	C	Order No.
SD		0,4	2,5	75	9009030000
SD		0,5	3,0	80	9008320000
SD		0,6	3,5	100	9008330000
SD		0,8	4,0	100	9008340000
SD		0,8	4,5	125	9009020000
SD		1,0	5,5	150	9008350000
SD		1,2	6,5	150	9009010000

**Tension clamp terminal tool**

**Tool for PCB terminals with tension clamp connections**

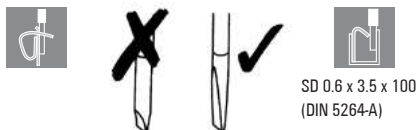

You do not need any special tool to connect or disconnect our tension clamp connections. The opening is designed to accommodate a standard 0.6 x 3.5 x 100 screwdriver to DIN 5264-A (with flat blade), also available from Weidmüller.

**SDK PH**

**Crosshead screwdriver**



**Crosshead screwdriver PH (Philips)**

- SDK PH DIN 5262, ISO 8764/2-PH
- Output acc. to ISO 8764-PH
- ChromTop tip
- SoftFinish® grip



**Crosshead screwdriver PZ (PoziDrive)**

- SDK PZ DIN 5262, ISO 8764/2-PZ
- Output acc. to ISO 8764-PZ
- ChromTop tip
- SoftFinish® grip



**Ordering data PH**

Type	Dims (mm)	A	B	C	Order No.
SDK PH0	0			60	9008470000
SDK PH1	1			80	9008480000
SDK PH2	2			100	9008490000
SDK PH3	3			150	9008500000

**Ordering data PZ**

Type	Dims (mm)	A	B	C	Order No.
SDK PZ1	1			80	9008530000
SDK PZ2	2			100	9008540000
SDK PZ3	3			150	9008550000

**N**



# Service and support

---

<b>Service and support</b>	Our expertise for your requirements	V.2
	Benefit from optimum support when using our products	V.4

---

## Our expertise for your requirements

### Service connects - worldwide

Automation technology functions are becoming more complex in a globally-oriented world facing ambitious targets in terms of energy efficiency and smart production. We are your equal partners for the best connections in Industrial Connectivity. Our worldwide network of industrial managers for machine construction, process automation, energy and traffic engineering and for device manufacturers know the challenges you face and can support you in your specific applications.

Training course on technologies, applications and the detailed functionality of our products is available to you locally or at our headquarter in Germany. Our personal support can answer any questions reliably and expertly. Our online services are available 365 day a year around the clock to provide answers to your questions on our products - from user documentation through software to planning tools.

In short: Weidmüller's global service combines our expertise with your requirements.





### Professional advice on planning

Our global network of industrial managers has extensive experience in automation technology and electrical connectivity. This expertise allows us to assist you with advice and planning support in order to work with you on resolving the everyday challenges of your applications.



### Technology and application training

Industrial automation is moving towards smart production. It faces the challenges of new technologies and applications. Our varied range of training courses develops this knowledge further or provides more in-depth information on the handling of our products and solutions. Our seminars are modular and can be customised. We can train you and your employees in our academy, on your premises if you wish or online in our webinars at any time.



### Customised installation

The challenges for the future are reducing costs and increasing efficiency. This requires intelligent, individual solutions which are tailored to your requirements. We can offer a highly qualified customer-specific production service in our application centre. Whether you need modified products, pre-assembled terminal rails or complete small cabinets: we produce the solutions developed for your application quickly and flexibly.

## Online support and downloads

# Exactly the right help and information on our solutions and products

If our products are used in your automation technology applications, you need the best possible individual support, from planning through installation to operation.

For every stage of your application, we can offer the right tools and information for our products and solutions. Up-to-date, uncomplicated, comprehensive and around the clock via our service portal at [www.weidmueller.com/service](http://www.weidmueller.com/service).

Fast access to our support and services is available via Weidmüller webcodes. Simply select the service you want on the right hand side, then enter the webcode made up of five digits with a preceding hashtag into the search field in the top right corner of [www.weidmueller.com](http://www.weidmueller.com) and it will bring up the details you need.



### Online and personal support

From planning through installation to operation, we can provide exactly the right help and information for each step of your application based on our solutions and products: up-to-date, uncomplicated and comprehensive, around the clock, online or in person.



Visit our website  
for more information

[www.weidmueller.com/service](http://www.weidmueller.com/service)

Let's connect.

### Engineering Support

As a developer, you need simple processes and system-wide tools. We support you in your development environment with comprehensive data, software tools and interfaces, product selection guides and development samples.



**Engineering data**  
Webcode #01219



**Product software**  
Webcode #01212



**Whitepaper for device connectivity**  
Webcode #11359



**Engineering software**  
Webcode #11377



**Product configurators, product selection guides and samples**  
Webcode #01214

### Technical data and downloads

Download all the documents and software relating to our products by simply entering the item number. You can also view our Online Catalogue and research the technical properties of our products.



**Find downloads**  
Webcode #11379



**Products in the Online Catalogue**  
Webcode #01217



**Security Advisory Board**  
Webcode #11424

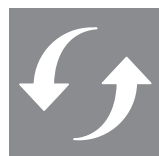

**Product Change Notification**  
Webcode #11425

### Commercial support

Integrate our product data into your commercial system using standardised interfaces or familiarise yourself with the wide range of products in our technical catalogues.



**Electronic catalogue in BMECat format and other formats**  
Webcode #11378



**Access our Webshop**  
Webcode #11382



**Technical catalogue in PDF Format**  
Webcode #01218

### More offers in online support and downloads

Not found what you are looking for? We have even more to offer you in online support and downloads.



**Approvals, certificates and declaration of conformity**  
Webcode #11374

Here you will find information on the CE declaration of conformity, on RoHS and REACH and other company related certificates and approvals.





# Technical appendix

<b>Technical appendix</b>	Overview of the icons used in the catalogue	W.2
	Wire connection technologies and surface mounting	W.4
	Fastening options for OMNIMATE® device connection technology	W.8
	Insulating materials	W.12
	Metals	W.14
	Derating curve	W.15
	Measurement of clearance and creepage distances according to VDE / IEC	W.16
	Measurement of clearance and creepage distances according to UL	W.20
	UL design-in recommendations for 600 V applications	W.21
	Device connection technology in the reflow soldering process (SMT)	W.22
	The SMD solder connection	W.28
	AWG conductor table	W.29

# Overview of icons used in catalogue

The OMNIMATE® device connection methodology and electronics housing range is highly flexible, ensuring your application requirements are met. The more familiar you are with it, the easier it is to find the optimum component. To help you, we have listed and described the meaning of icons used in the catalogue. Let's connect.

## Grid size in mm



Different grid sizes of between 3.50 mm and 15.00 mm require different installation sizes to meet electrical requirements.

## Outlet direction of terminals, connectors and plugs



Each device design requires different wire feeds or actuation directions. Combine options between 90° and 270°.

## Soldering connection technology



Choose from manual, wave or reflow soldering with push-through or surface mounting. OMNIMATE® can do it all.

## Wire connection method

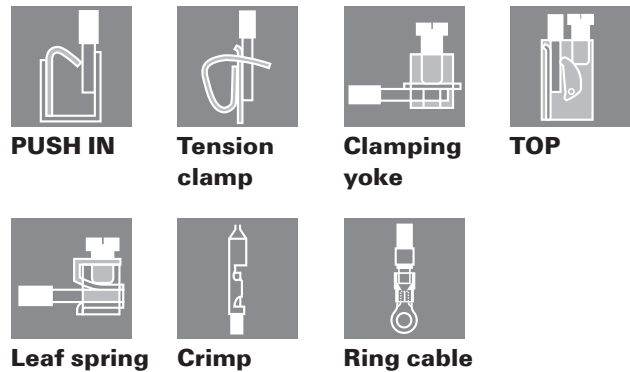

One of our core competencies. Individual strand connections for any application – tried-and-tested effectiveness.

## Wire cross-section, in mm<sup>2</sup>



Different wire thicknesses of between 0.14 mm<sup>2</sup> and 95 mm<sup>2</sup> require different installation sizes for the mechanical and electrical requirements to be met.

### Component design of terminals, connectors and plugs



Single-row is standard. Multi-row and multi-story designs increase the packing density and enable a large number of connections in a smaller space.

### Type of packaging



Whether they come on reels, as tubes or boxes – our components are optimally packed so that they are fit for purpose.

### Feature of our OMNIMATE® Power products



Can be used for 600 V according to UL

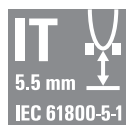

Can be used for IT networks according to IEC 61800-5-1

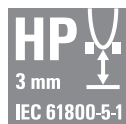

Can be used for very stringent requirements according to IEC 61800-5-1

### Our service



Your time-saving, design-in sample service

# Connection system

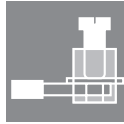

## Clamping yoke screw connection

The clamping-yoke connection is the most used screw connection in the world. Steel clamping-yokes made of using a stamping and bending process guarantee a vibration proof clamp connection. When the screw on the clamp is tightened, there is a counter effect in the clamping yoke's threaded area which prevents the connection accidentally loosening. As the screw thread is on an inclined plane, there is a force gain created and a very high clamping force is achieved. Weidmüller uses hardened steel with optimal corrosion protection for stability and security and copper alloys in the contact area for good electrical conductivity.

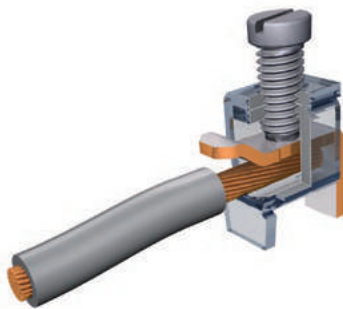

### Customer benefits:

- The screw connection guarantees a globally accepted, vibration proof and maintenance free connection.
- A large conductor clamping area is covered.
- The "Wire Ready" technology ensures that the terminal points are fully open at delivery, even after being transported world-wide
- The "Wire Guard" protection mechanism prevents accidental insertion of the wire underneath the clamping area which can be dangerous, it protects against hidden faulty contacts
- The flat clamping yoke also enables the clamping of very small cross-section wires

### Field of application:

The standard connection for applications in industrial environments with the highest requirements for reliability even under harsh conditions.



## PUSH IN spring connection

The PUSH IN spring connection with direct plug-in technology allows the fastest wiring process: the stripped or prepared wire is simply pushed into the terminal point as far as it will go and the connection is finished. Operating the release lever is only required with flexible wires or to release the connection. The stainless steel spring ensures a high contact force between wire and the tinned copper busbar. A stainless steel cage enclosure prevents subsidence in the contact area. To prevent any drop in clamping force plastic parts were deliberately not used.

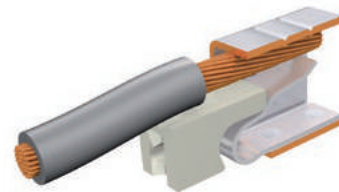

### Customer benefits:

- Fast, tool-less wire connection with direct insertion technology
- The stainless steel spring results in a vibration-resistant connection
- Higher resistance to wire pull-out than in a tension clamp system
- Constant conductor clamping force independent of the operator
- Operator error is reduced using a colour-coded and intuitive actuator
- Wire feed and the operation are aligned in the same direction which permits a compact equipment design

### Field of application:

The default choice for operation in the field; it permits speedy wiring and, combined with its small size, its intuitive use is also advantageous even in environments with severe vibration.

### TOP screw connection terminal with Pull-Effect



In the traditional case, the screw is always at a right angle to the conductor outlet direction. The TOP connection, however, allows wire insertion and the screw orientation in the same direction. The TOP connection produces the greatest possible packing density in the terminal area. The "pull effect" ensures that the connected wire is pulled in to the clamping point producing a secure contact.

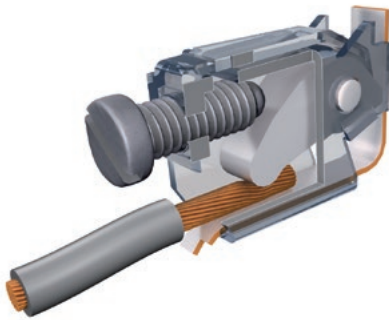

#### Customer benefits:

- The "pull effect" pulls the wire into the terminal point. Problems with clearance and creepage distances are avoided.
- Wire feed and the operation are aligned in the same direction which permits a compact equipment design
- The minimum installation height results in an extremely high packing density

#### Field of application:

Housing design or installation requirements such as PCB slots, that do not allow a right angled screw operation for reasons of space.

### Tension clamp connection



The pre-tensioned tension clamp is made from high quality rust and acid resistant steel, which pulls the wire against the galvanised copper busbar. This results in a permanent and vibration resistant connection. Operation is simple; the spring is opened with a screwdriver, wire is fed through the wire guide into the spring cage and the screwdriver is removed resulting in a clamped wire. The surface-treated busbar ensures low contact resistance and a high resistance to corrosion.



#### Customer benefits:

- Constant conductor clamping force independent of the operator
- Wide-spread connection technology
- Simple operation using a screwdriver or the integrated release lever

#### Field of application:

Fast wiring with a constant clamping force, even in environments with severe vibration.

# Connection system



## Leaf spring screw connection

The leaf spring screw connection is the oldest technology on the market for connecting a conductor. The leaf spring prevents damage to the conductor when the clamp screw is tightened. The leaf spring is a simplified connection yet suited for the requirements of building automation connection technology.



### Customer benefits:

- Cost effective alternative to the clamping-yoke connection
- A particularly simple connection solution suited to less demanding environmental conditions.
- High power density in a small footprint

### Field of application:

Applications with less demanding environmental conditions and narrow installation space.



## Crimp connection

The crimp connection technology provides an affordable solution with pre-assembled female plugs that is also appropriate for large batch jobs. The crimp contacts can be attached using hand tools or with a crimping machine for producing large batches. The contacts are then locked into the housing provided. For fully automated processing, taped crimp contacts are available.



### Customer benefits:

- Rapid, fully automated pre-assembly of connectors is possible
- Long-lasting, positive connection technologies
- Minimal contact resistances
- The conductor connection is extremely thermal shock and vibration resistant

### Field of application:

Applications that combine fully automatic and factory oriented processing steps with the actual field wiring. Works in environments with severe vibration or temperature fluctuations.

# Surface mounting

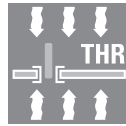

## THR soldered connection

Reflow products in THT (through-hole technology) are the best alternative to using just SMT (surface-mount technology) if higher forces might be operating on the printed-circuit board components. The component design of Weidmüller products is specifically developed for this application and takes into account the requirements in terms of structural shape, temperature stability and processing for THT products from the word "go".

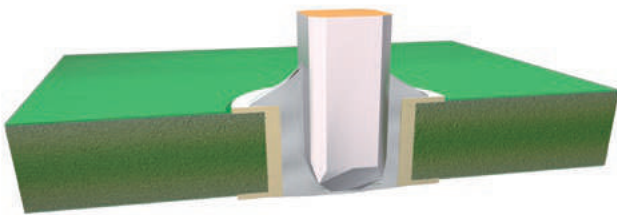

### Customer benefits:

- Special temperature-resistant plastics with a melting point of over 300 °C.
- 2 pin lengths – 1.5 mm for low paste requirements and 3.2 mm for focus on quality assurance.
- Packed in standard cardboard boxes or antistatic belts, for use in pick-and-place machines.
- Comparably higher current-carrying capacity due to the plastic's high temperature stability.

### Field of application:

Applications where fast processing and reliable and stable connections to the printed-circuit board are of the essence. Reflow, wave or hand soldering with high temperature requirements.



## SMD surface soldering connection

Electronic subassemblies are manufactured economically using surface-mount technology (SMT) with surface-mount devices (SMD). Design measures such as co-planarity and the size/shape of the soldering pads lend electromechanical components a reliable and stable printed-circuit board connection. The structural shape and temperature stability of Weidmüller SMD components are matched to processing in automated surface mounting equipment.

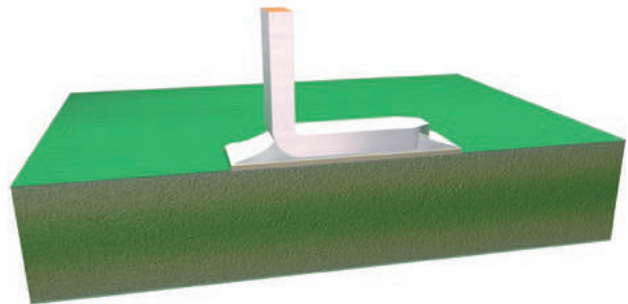

### Customer benefits:

- In contrast to THR, no holes are necessary for printed-circuit boards (for instance, with glass ceramic-printed circuit boards).
- Two soldering pads per connecting point boost mechanical stability.
- Standard packaging in the antistatic belt means it can be used in pick-and-place machines.
- High dimensional stability due to plastic with a high level of temperature resistance, with a melting point over 300 °C.

### Field of application:

Subassemblies that are exclusively equipped with SMD components and exposed to medium electromechanical loads.

# You are looking for the best connectors for your project

## We help you find the right solution

Every new design needs different components to provide a suitable solution for your application. For example, the mating connectors on the PCB and in the housing have to meet different requirements. When installing the mating connectors, your customers will expect enhanced features for safety and convenience.

### Possible fastening options for male and female connectors on the printed circuit board:

#### Connector without fastening option for the plug

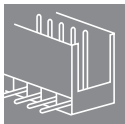

**Open (O):** this simplest connector version has no side panels. Open variants can be positioned next to one another without a loss of poles (end-stackable). Two 2-pole connectors can therefore be used to produce one 4-pole connector on the printed circuit board. The end-stackable design is flexible when producing very large numbers of poles on the printed circuit board.

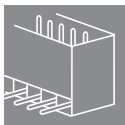

**Closed (G):** closed versions are used to prevent the plug being incorrectly inserted and to provide better dust protection. Ideally suited to prevent mismatching.

#### Connector with secure fastening with screw option

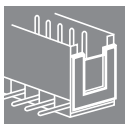

**Dovetail (B):** the dovetail variant is closed and allows mounted blocks to be added. Our mounting options deliver all the flexibility you require.

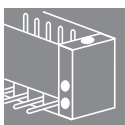

**Flange with nut (F):** for the classic screw option, each flange is paired with a nut for the screw in the flange plug counterpart.

#### Connector with additional fastening on printed circuit board

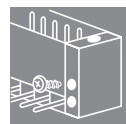

**With optional screw:** for increased mechanical stability, you can also use a screw to fasten the flange connector to the PCB. An extra hole must be provided on the printed circuit board for the screws.

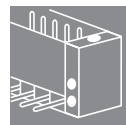

**With solder pin (LF):** solder flange rather than screw. For increased mechanical stability on the printed circuit board, an additional solder pin is integrated into the flange sides on the printed circuit board. This pin can be simply soldered during the soldering process. There is no need for any more screw connections.

#### Connector with fastening option for plug – with release latch

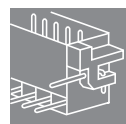

**Clip-on flange (RF):** if you only want to link connectors and plugs with a release latch and don't want to fix them with a screw, this is the best solution. The clip-on flange provides the plug's latching hook, with the contour needed to ensure a secure fix, which is easy to release later on.

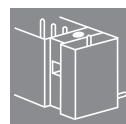

**Middle flange (MF):** for some OMNIMATE® Power series, alongside the classic flange versions located externally on the right and left of the male and female connectors, we also provide an innovative middle flange with a latching hook mechanism. This clever solution makes very simple and safe handling possible. The pin and plug can be securely fixed and released with just one hand. As an option, the clip-on flange, with an extra nut in the male connector, can also be screwed down to the plug. Variants with a solder pin for additional fixing on the printed circuit board are also possible.



## Fixing and releasing a plug with the connector / device:

### Plug without fixing option



**Closed (G):** the standard version – without additional flange or latch. To release, simply pull the plug. In most series, the plugs can be plugged next to one another, without a loss of poles.

### Plug with fastening option – with screw



**Dovetail (B):** the variant with a dovetail contour on the left and right is closed and if necessary, you can mount extra small fastening blocks (flanges) for installation. With little effort, you can therefore prepare versions

which are both closed and feature a flange.

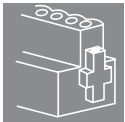

**Flange version (F):** plugs with flange have a screw on either end. This ensures secure fixing of the plug with the matching connector, with flange and nut. Increased safety means that no one can release the plug by mistake.

In our OMNIMATE® Power series, a latching hook provides secure retention. The screw can also be used for fastening purposes. The latch between the plug and pin can be released by simply pressing on both sides.

### Plug with convenient release function – with release lever or latch



**Release latch (LR):** there is a lever on the right and left of the plug which can be easily moved by pressing with a screwdriver or fingers. Plug and pin are also automatically linked with just one click. Because of the lock mechanism, the plug cannot be released by mistake. Pulling forces are increased, for connectors with large numbers of pins in particular. However the release latch can be used to simply release the plug from the connector with flange, or from the housing without the wires having to be pulled. The plug can only be released from the pin by manually unlocking the release catch at the same time.

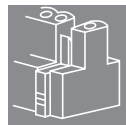

**Middle flange (MF):** for some OMNIMATE® Power series, alongside the classic flange versions located on the right and left of the male and female plugs, we also provide an innovative middle flange. This clever solution makes very simple and safe handling possible. The pin and plug can be securely fixed and released with just one hand. To fix the components, either simply latch together or, for increased safety, you can also insert a screw through the latching hook.

# Fastening options for OMNIMATE® printed-circuit board plug-and-socket connectors

## Flange options for plug-and-socket connectors

<http://www.OMNIMATE.net>

- = recommended
- = possible to a limited extent

				Fastening for the printed-circuit board		O		G	
						open		closed	
						no		no	
OMNIMATE® Power	MF/MSF	centre flange	locking hook/ with screw						
	F1/SF1	inverted flange	locking hook/ with screw						
	F	flange	locking hook						
	LR	release latch	bar						
	LH	release gear	no						
	FI	inverted flange	nut						
	F	flange	screw						
	B	dovetail for B block	via accessories with a screw						
	G	closed	no						
					Fastening for the strip				
				Female connector					
				Male connector					

W

B	F / FI	LF/LFI/FLF	RF	MF/MSF
dovetail for B block	flange with nut	flange with nut	locking flange without a nut (for release latch)	centre flange with/without nut
with the nut from accessories	optional screw	terminal pin	terminal pin	terminal pin (partially)

Pin headers

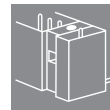
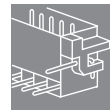
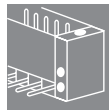
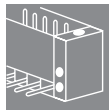
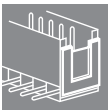

Socket terminal strips

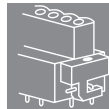
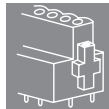
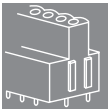

●	●	●	●	●
●	●	●	●	●
●	●	●	●	●
●	●	●	●	●
●	●	●	●	●
●	●	●	●	●
●	●	●	●	●
●	●	●	●	●
●	●	●	●	●
●	●	●	●	●
●	●	●	●	●
●	●	●	●	●
●	●	●	●	●

# Insulating materials

Weidmüller uses different insulating materials because of the diverse requirements placed on our products. The insulating materials do not contain any hazardous substances. The use of cadmium-free materials is a very high priority. Our insulating materials contain neither pigments based on heavy metals nor any substances that lead to the formation of dioxin or furan.

Thermoplastics			
Plastic Abbreviation	Wemid PA66	Wemid GF	Polyamide PA
	<p><b>Wemid</b> is a modified thermoplastic, its properties are specially tailored to meet the needs of our cable connectors. Advantages over PA are the improved fire protection and the higher sustained working temperature. WEMID meets the stringent requirements for use in railway carriages according to NF F 16-101.</p>	<p><b>Glass-fibre reinforced WEMID</b> offers excellent dimensional stability and very good mechanical properties. This makes a difference when used as an end bracket. The material falls in the V-0 flammability class according to UL 94.</p>	<p><b>Polyamide (PA)</b> is one of the most widely used engineering plastics. Advantages of this material are its good electrical and mechanical characteristics, its flexibility and resistance to breakage. In addition, PA offers good fire resistance on account of its chemical structure even without the addition of flame retardants.</p>
Description	<p>higher sustained working temperature</p> <p>improved fire resistance</p> <p>halogen-free and phosphor-free flame-retardant material</p> <p>low smoke produced in the event of fire</p> <p>permitted for use in railway applications following NF F 16-101 specifications</p>	<p>excellent dimensional stability</p> <p>very good mechanical characteristics</p> <p>halogen-free flame retardant material</p>	<p>flexible, resistant to breakage</p> <p>good electrical and mechanical characteristics</p> <p>self-extinguishing characteristic</p> <p>halogen-free flame retardant material</p>
Properties			
Specific volume resistance to IEC 60093	$\Omega \times \text{cm}$	$10^{12}$	$10^{15}$
Electric strength to IEC 60243-1	kV / mm	25	35
Tracking resistance (A) to IEC 60112	CTI	600	550
Upper max. permissible temperature	°C	120	120
Lower max. permissible temperature, static	°C	-50	-40
Flamability class to UL 94		V-0	V-0
Fire behaviour to railway standard		I2 / F2 *)	-

W

**Thermoplastics**

Polyamide PAGF	Polybutylene terephthalate PBT	Polybutylene terephthalate PBT (GF)	Polycarbonate PC	Liquid crystal polymer LCP (GF)
<p><b>Glass-fibre reinforced polyamide (PAGF)</b> offers excellent dimensional stability and very good mechanical characteristics. This makes a difference when used as an end bracket. As compared to unreinforced PA, this material has flammability rating HB according to UL 94.</p>	<p><b>Thermoplastic polyester (PBT)</b> offers excellent dimensional stability (hence its use in plug connectors) and a high constant operating temperature. Compared to other insulating materials, the creepage-current resistance is lower.</p>	<p><b>Thermoplastic polyester (PBT/glass fibre reinforced)</b> offers excellent dimensional stability (hence its use in plug connectors) and a high constant operating temperature. Compared to other insulating materials, the creepage-current resistance is lower.</p>	<p><b>Polycarbonate (PC)</b> is an impact-resistant (unbreakable), crystal-clear material which is not easily scratched. It is particularly suitable for use in transparent covers.</p>	<p><b>LCP (glass fibre reinforced)</b> offers excellent dimensional stability, particularly at high temperatures. As the material is similar to PCBs and has a very low thermal expansion coefficient, it is particularly suitable for components that are soldered in the reflow oven.</p>
<p>excellent dimensional stability very good mechanical characteristics halogen-free flame retardant material</p>	<p>high dimensional stability good electrical and mechanical characteristics Flame retardants that do not form dioxin or furan.</p>	<p>high dimensional stability good electrical and mechanical characteristics Flame retardants that do not form dioxin or furan.</p>	<p>high dimensional stability high constant operating temperature high electrical insulation properties halogen-free flame retardant material</p>	<p>excellent dimensional stability high constant operating temperature minimal water absorption low thermal expansion coefficient</p>
<p>10<sup>12</sup> 30 500 100 -50 HB</p>	<p>10<sup>13</sup> 28 200 115 -50 V-0</p>	<p>10<sup>13</sup> 29 200 130 -50 V-0</p>	<p>10<sup>16</sup> ≥ 30 ≥ 175 115 / 125 -50 V-2 / V-0 I2 / F2</p>	<p>10<sup>15</sup> 35 175 240 -50 V-0 -</p>

# Metals

## Metals

All the metals used by Weidmüller are selected and processed with their surfaces treated according to the latest technical standards.

### Steels

Steel parts are electrogalvanised and treated with an additional Weidmüller passivation technique, WInQ®. The surface protection conforms to the highest standards, is matched to the special requirements of the connection systems used and is RoHS-compatible (RoHS = Restriction of Hazardous Substances). Experience gained from storage in outdoor test racks at different locations (industrial, marine, tropical and normal atmospheres) has been incorporated into the design of the surface protection.

Zinc protects against corrosion for a long time even after the zinc coating has been partially damaged by scratches or pores. In the presence of an electrolyte, zinc acts as a cathode (i.e. negative) with respect to steel. The metal ions of the zinc migrate to the steel, which provides long-term protection for the parent metal.

## Conductive materials

The current-carrying materials copper, brass and bronze are characterised by a high conductivity plus good mechanical properties. The surfaces are usually given a coating of tin, which creates an extremely good, "malleable" contact with a low contact resistance.

Apart from ensuring consistently good electrical properties, the tin coating provides excellent protection against corrosion. Solder connections are also given a coating of tin.

In order to guarantee the long-term solderability (shelf life), the brass parts are given an additional nickel coating as a diffusion barrier. The nickel coating provides effective protection against the loss of zinc atoms from the brass.

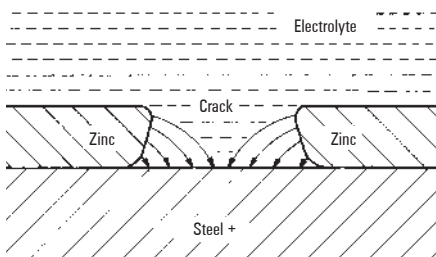

# Derating curve (current-carrying capacity curve)

The **derating curve** shows which currents may flow continuously and simultaneously via all possible connections when the component is subjected to various ambient temperatures below its upper limit temperature.

The **upper limit temperature** of a component is the rated value determined by the materials used. The total of the ambient temperature plus the temperature rise caused by the current load (power loss at volume resistance) may not exceed the upper limit temperature of the component, otherwise it will be damaged or even completely ruined.

The current-carrying capacity is hence not a constant value, but rather decreases as the component ambient temperature increases. Furthermore, the current-carrying capacity is influenced by the geometry of the component, the number of poles and the conductor(s) connected to it. The current-carrying capacity is determined empirically according to DIN IEC 605 12-3. To do this, the resulting component temperatures  $t_{b1}, t_{b2} \dots$  and the ambient temperatures  $t_{u1}, t_{u2}$  are measured for three different currents  $I_1, I_2, I_3 \dots$

The values are entered on a graph with a system of linear coordinates to illustrate the relationships between the currents, the ambient temperatures and the temperature rise in the component.

The **loading currents** are plotted on the y-axis, the **component ambient temperatures** on the x-axis.

A line drawn perpendicular to the x-axis at the upper limit temperature  $t_g$  of the component completes the system of coordinates.

The associated average values of the temperature rise in the component,  $\Delta t_1 = t_{b1} - t_{u1}, \Delta t_2 = t_{b2} - t_{u2}, \dots$  are plotted for every current  $I_1, I_2, \dots$  to the left of the perpendicular line. The points generated in this way are joined to form a roughly parabolic curve.

As it is practically impossible to choose components with the maximum permissible volume resistances for the measurements, the base curve must be reduced.

Reducing the currents to 80 % results in the **"derating curve"** in which the maximum permissible volume resistances and the measuring uncertainties in the temperature measurements are taken into account in such a way that they are suitable for practical applications, as experience has shown. If the derating curve exceeds the currents in the low ambient temperature zone, which is given by the current-carrying capacity of the conductor cross-sections to be connected, then the derating curve should be limited to the smaller current in this zone.

### Base curve

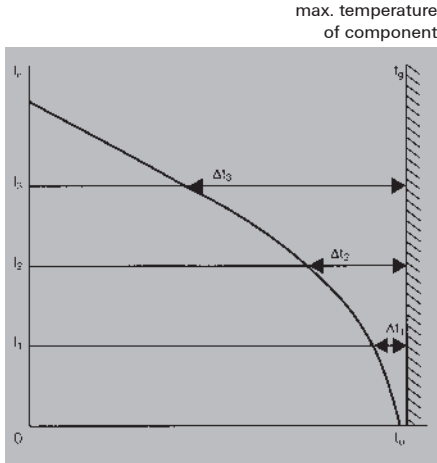

$t_g$  = upper limit temperature of component  
 $t_u$  = ambient temperature  
 $I_n$  = current

### Derating curve

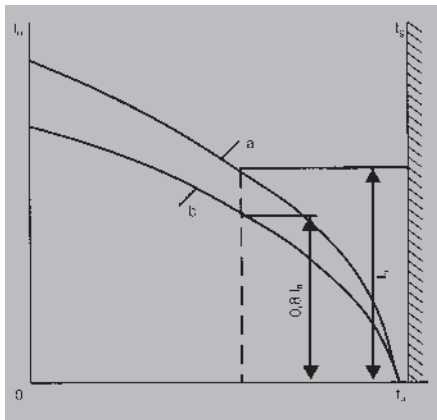

$t_g$  = upper limit temperature of component  
 $t_u$  = ambient temperature  
 $I_n$  = current  
a = base curve  
b = reduced base curve (derating curve)

### Example: derating curve for minimum and maximum number of poles

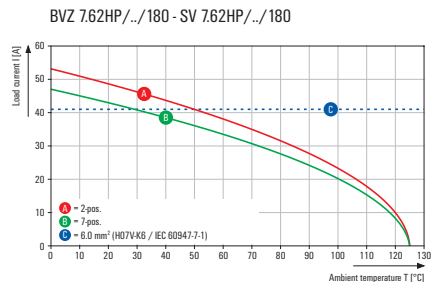

# Design of clearance and creepage distances in electrical equipment

**General:**

Since April 1997 the sizing of clearance and creepage distances has been covered by DIN VDE 0110 part 1 "Insulation coordination for electrical equipment in low-voltage systems".

DIN VDE 0110 part 1 contains the modified edition of IEC Report 664-1 (see also IEC 664-1/Oct 1992). The design data resulting from these provisions is – if applicable – specified in this catalogue for each product.

**Dimensioning of clearance and creepage distances to VDE 0110/Apr 1997 (IEC Report 664-1) "Insulation coordination for electrical equipment in low-voltage systems"**

The provisions for insulation coordination result in the following relationships for dimensioning of clearance and creepage distances:

**Table 1: Rated impulse withstand voltages for electrical equipment**

Rated voltage of power supply system*) in V		Rated impulse withstand voltage in kV			
Three-phase systems	Single-phase systems with neutral point	Electrical equipment at the supply point of the installation (Overvoltage category IV)	Electrical equipment as part of the permanent installation (Overvoltage category III)	Electrical equipment to be connected to the permanent installation (Overvoltage category II)	Specially protected electrical equipment (Overvoltage category I)
	120 to 240	4,00	2,50	1,50	0,80
230/400 277/480		6,00	4,00	2,50	1,50
400/690 1000		8,00	6,00	4,00	2,50
		Values depend on the particular project or, if no values are available, the values above for 400/690 V can be used.			

\*) to IEC 38

Category I is valid for specially rated equipment.

Category II is valid for technical committees responsible for electrical equipment specified for connecting to the mains power supply.

Category III is valid for technical committees responsible for installation materials, and for some specific technical committees.

Category IV is valid for power supply companies and particular projects.

- **Clearances** are dimensioned according to the anticipated **overvoltages** taking into account the ratings of the **overvoltage protection precautions** in use and the anticipated environmental conditions taking into account the protective measures taken to prevent **pollution**.

- **Creepage distances** are dimensioned according to the **operating voltage** and the anticipated environmental conditions taking into account the **insulating materials** used and the protective measures taken to prevent **pollution**.

**Dimensioning of clearances**

Decisive for the dimensioning of clearances are the **rated impulse withstand voltages** shown in table 1, which are derived from the **overvoltage category** and the **phase-to-earth voltage** depending on the rated mains voltage (taking into account all types of supply systems).

The minimum clearances (up to site altitudes of 2000 m above mean sea level) are determined from table 2a based on the **rated impulse withstand voltage** and the **pollution severity**.

Note: Clearances that do not comply with case A must be subjected to an impulse withstand voltage test (see table 2a, footnote 1).

**Table 2a: Minimum clearances to VDE 0110-1/Apr 1997**

Rated impulse withstand volt. in KV	Minimum clearance distances in mm for sites up to 2000 m above sea level										
	Case A (inhomogeneous field)				Case B (homogeneous field)						
	Pollution severity				Pollution severity						
	1	2	1)	3	4	1	2	1)	3	4	
0,33	0,01			0,80	1,60	0,01	0,20	0,20	0,80	1,60	
0,40	0,02		0,10			0,02					0,10
0,50	0,04	0,20				0,04					
0,60	0,06		0,12			0,06					0,12
0,80	0,10					0,10					
1,00	0,15		0,20			0,15					0,20
1,20	0,25	0,25				0,20					
1,50	0,50	0,25				0,30					0,30
2,00	1,00	1,00	1,00			0,45					0,45
2,50	1,50	1,50	1,50			0,60					0,60
3,00	2,00	2,00	2,00	0,80	0,80						
4,00	3,00	3,00	3,00	1,20	1,20	1,20					
5,00	4,00	4,00	4,00	4,00	4,00	1,50	1,50	1,50			
6,00	5,50	5,50	5,50	5,50	5,50	2,00	2,00	2,00	2,00		
8,00	8,00	8,00	8,00	8,00	8,00	3,00	3,00	3,00	3,00	3,00	
10,00	11,00	11,00	11,00	11,00	11,00	3,50	3,50	3,50	3,50	3,50	
12,00	14,00	14,00	14,00	14,00	14,00	4,50	4,50	4,50	4,50	4,50	
15,00	18,00	18,00	18,00	18,00	18,00	5,50	5,50	5,50	5,50	5,50	

1) Pollution severity 2 is split for impulse voltages up to 1.00 kV (case A) or 1.20 kV (case B). These values apply for printed circuits but deviate from those in IEC Report 664.





The **pollution severity categories** are as follows:

Pollution severity category 1:  
No pollution, or only dry, non-conductive pollution that has no influence.

Pollution severity category 2:  
Non-conductive pollution only; occasional condensation may cause temporary conductivity.

Pollution severity category 3:  
Conductive pollution, or dry, non-conductive pollution that is liable to be rendered conductive through condensation.

Pollution severity category 4:  
Contamination results in constant conductivity, e.g. caused by conductive dust, rain or snow.

The following aspects apply to the **overvoltage categories** in accordance with the German standard DIN VDE 0110-1:

*Electrical equipment fed directly from the low-voltage mains*  
Specification of a specific overvoltage category shall be based on the following:

– Equipment of *overvoltage category I* is equipment that is intended to be connected to the permanent electrical installation of a building. Measures to limit transient overvoltages to the specific level are taken outside the equipment, either in the permanent installation or between the permanent installation and the equipment.

– Equipment of *overvoltage category II* is equipment to be connected to the permanent electrical installation of a building.

Note: Examples of such equipment are household appliances, portable tools and similar loads.

– Equipment of *overvoltage category III* is equipment that is part of the permanent electrical installation and other equipment where a higher degree of availability is expected.

Note: Examples of such equipment are distribution boards, circuit-breakers, wiring systems (IEV 826-06-01, including cables, busbars, junction boxes, switches,

power sockets) in the permanent installation, and equipment for industrial use and some other equipment, e.g. stationary motors with permanent connections to the permanent installation.

– Equipment of *overvoltage category IV* is for use at or in the proximity of the incoming supply point of the electrical installations of buildings upstream of the main distribution board.

**Table 3a: Single-phase 2- or 3-wire AC or DC systems**

Rated voltage of the power supply (mains) <sup>1)</sup>	Voltages for table 4	
	For insulation phase-to-phase <sup>1)</sup>	For insulation phase-to-earth <sup>1)</sup>
	All systems	3-wire systems, neutr. point earthing
V	V	V
12,5	12,5	-
24	25	-
25		
30	32	-
42		
48	50	-
50**)		
60	63	-
30-60	63	32
100**)	100	-
110	125	-
120		
150**)	160	-
220	250	-
110-220	250	125
120-240		
300**)	320	-
220-440	500	250
600**)	630	-
480-960	1000	500
1000**)	1000	-

1) Phase-to-earth insulation levels for unearthed or impedance-earthed systems are equal to those of phase-to-phase because the operating voltage to earth of any phase can, in practice, reach full phase-to-phase voltage. This is because the actual voltage to earth is determined by the insulation resistance and capacitive reactance of each phase to earth; thus, a low (but acceptable) insulation resistance of one phase can earth it and raise the other two to full phase-to-phase voltage to earth.

\*) It is assumed that the rated voltage of the electrical equipment is not lower than the nominal voltage of the power supply.

\*\*\*) Because of the common changes, the meaning of the \*\* symbol has not been used in table 1; i.e. the / symbol indicates a 4-wire 3-phase distribution system. The lower value is the phase-to-neutral voltage, while the higher value is the phase-to-phase voltage. Where only one value is indicated, it refers to 3-wire, 3-phase systems and specifies the value phase-to-phase. The values given in table 1 are still taken into account in tables 3a and 3b by the \*\* symbol.

**Table 3b: 3-phase 3- or 4-wire AC systems**

Rated voltage of the power supply (mains) <sup>1)</sup>	Voltages for table 4			
	For insulation phase-to-phase <sup>1)</sup>	For insulation phase-to-earth <sup>1)</sup>		
		All systems	3-phase 4-wire systems with earthed neutral wire <sup>2)</sup>	3-phase 3-wire systems unearthed <sup>1)</sup> or phase-earthed
V	V	V	V	
60	63	32	63	
110/120/127	125	80	125	
150**)	160	-	160	
208	200	125	200	
220/230/240	250	160	250	
300**)	320	-	320	
380/400/415	400	250	400	
440	500	250	500	
480/500	500	320	500	
575	630	400	630	
600**)	630	-	630	
660/690	630	400	630	
720/830	800	500	800	
960	1000	630	1000	
1000**)	1000	-	1000	

1) Phase-to-earth insulation levels for unearthed or impedance-earthed systems are equal to those of phase-to-phase because the operating voltage to earth of any phase can, in practice, reach full phase-to-phase voltage. This is because the actual voltage to earth is determined by the insulation resistance and capacitive reactance of each phase to earth; thus, a low (but acceptable) insulation resistance of one phase can earth it and raise the other two to full phase-to-phase voltage to earth.

2) For electrical equipment for use in both 3-phase 4-wire and 3-phase 3-wire supplies, earthed and unearthed, use the values for 3-wire systems only.

\*) It is assumed that the rated voltage of the electrical equipment is not lower than the nominal voltage of the power supply.

\*\*\*) Because of the common changes, the meaning of the \*\* symbol has not been used in table 1; i.e. the / symbol indicates a 4-wire 3-phase distribution system. The lower value is the phase-to-neutral voltage, while the higher value is the phase-to-phase voltage. Where only one value is indicated, it refers to 3-wire, 3-phase systems and specifies the value phase-to-phase. The values given in table 1 are still taken into account in tables 3a and 3b by the \*\* symbol.

Measurement of clearance and creepage distances according to VDE / IEC

Note: Examples of such equipment are electricity meters, circuit-breakers and ripple control units.

**Note on application of pollution severity and overvoltage categories**

The pollution severity and rated impulse withstand voltage derived from the overvoltage category are each specified in this catalogue and are product-related. In principle, the dimensioning of clearance and creepage distances, and the resulting specification of ratings for electromechanical products (terminal

blocks, terminal strips, PCB terminals/connectors) is based on pollution severity 3 and overvoltage category III considering all types of systems.

**Dimensioning of creepage distances**

Decisive for dimensioning of creepage distances are the rated voltages derived from the **system voltages** of the power supply for the respective **type of supply system** in conjunction with the **pollution severity** (classification, see "Clearances") and the **insulating material** used. Taking into account tables 3a and 3b and the CTI (Comparative Tracking

Index) of the insulating material, the minimum creepage distances are determined from table 4.

The insulating materials are subdivided into four groups according to their CTI (Comparative Tracking Index):

Insulating material	
I	600 ≤ CTI
II	400 ≤ CTI < 600
III a	175 ≤ CTI < 400
III b	100 ≤ CTI < 175

**Table 4: Minimum creepage distances**

Rated voltage  U <sub>eff</sub> or U <sub>i</sub> in V	Creepage distance in mm											
	Printed circuits		Other electrical equipment	Pollution severity								
	Pollution severity		1	2			3			4		
	Insulating mat.	Insulating mat.	Insulating mat.	Insulating material group			Insulating material group			Insulating material group		
2)	3)	2)	I	II	III	I	II	III <sup>4)</sup>	I	II	III <sup>4)</sup>	
10	0,025	0,04	0,08	0,40	0,40	0,40	1,00	1,00	1,00	1,60	1,60	1,60
12,5	0,025	0,04	0,09	0,42	0,42	0,42	1,05	1,05	1,05	1,60	1,60	1,60
16	0,025	0,04	0,10	0,45	0,45	0,45	1,10	1,10	1,10	1,60	1,60	1,60
20	0,025	0,04	0,11	0,48	0,48	0,48	1,20	1,20	1,20	1,60	1,60	1,60
25	0,025	0,04	0,125	0,50	0,50	0,50	1,25	1,25	1,25	1,70	1,70	1,70
32	0,025	0,04	0,14	0,53	0,53	0,53	1,30	1,30	1,30	1,80	1,80	1,80
40	0,025	0,04	0,16	0,56	0,80	1,10	1,40	1,60	1,80	1,90	2,40	3,00
50	0,025	0,04	0,18	0,60	0,85	1,20	1,50	1,70	1,90	2,00	2,50	3,20
63	0,040	0,63	0,20	0,63	0,90	1,25	1,60	1,80	2,00	2,10	2,60	3,40
80	0,063	0,10	0,22	0,67	0,95	1,30	1,70	1,90	2,10	2,20	2,80	3,60
100	0,10	0,16	0,25	0,71	1,00	1,40	1,80	2,00	2,20	2,40	3,00	3,80
125	0,16	0,25	0,28	0,75	1,05	1,50	1,90	2,10	2,40	2,50	3,20	4,00
160	0,25	0,40	0,32	0,80	1,10	1,60	2,00	2,20	2,50	3,20	4,00	5,00
200	0,40	0,63	0,42	1,00	1,40	2,00	2,50	2,80	3,20	4,00	5,00	6,30
250	0,56	1,00	0,56	1,25	1,80	2,50	3,20	3,60	4,00	5,00	6,30	8,00
320	0,75	1,60	0,75	1,60	2,20	3,20	4,00	4,50	5,00	6,30	8,00	10,00
400	1,00	2,00	1,00	2,00	2,80	4,00	5,00	5,60	6,30	8,00	10,00	12,50
500	1,30	2,50	1,30	2,50	3,60	5,00	6,30	7,10	8,00	10,00	12,50	16,00
630	1,80	3,20	1,80	3,20	4,50	6,30	8,00	9,00	10,00	12,50	16,00	20,00
800	2,40	4,00	2,40	4,00	5,60	8,00	10,00	11,00	12,50	16,00	20,00	25,00
1000	3,20	5,00	3,20	5,00	7,10	10,00	12,50	14,00	16,00	20,00	25,00	32,00

2) Insulating materials I, II, IIIa, IIIb  
 3) Insulating materials I, II, IIIa  
 4) Creepage distances are not determined in this range. Insulation group IIIb is generally not recommended for pollution severity 3 with voltages > 630 V, and is never recommended for pollution severity 4.



The comparative tracking index must be determined according to DIN IEC 112/VDE 0303 part 1 on the basis of specially prepared samples with test solution A.

**Slots** are taken into account in the measurement of creepage distances when their minimum width  $x$  is dimensioned according to the following table:

Pollution-severity	Minimum width $x$ mm
1	0,25
2	1,0
3	1,5
4	2,5

If the associated clearance is less than 3 mm, the minimum slot width can be reduced to 1/3 of the clearance.

## Clearance and creepage distances

The maximum voltage to be applied to the connector depends on the distance between two connections.

Two distances have to be taken in account:

- Clearance = shortest distance between two conductive parts (in air)
- Creepage distance = distance along surface

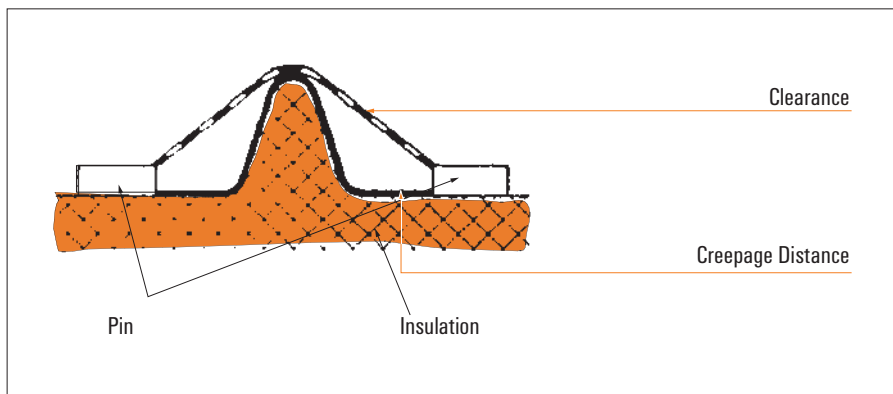

# Measurement of clearance and creepage distances according to UL

300 V

## Comparison of UL clearance and creepage distances for UL 300 Volt

				min. clearance	
UL 1059	minimum spacing (Table 8.1)	151 - 300 V		6.4 mm	9.5 mm
UL 508C	minimum spacing (Table 36.1)	151 - 300 V		6.4 mm	9.5 mm
UL 508C	minimum spacing for products with known controlled transient voltages (Table 36.3)	Peak working voltage:	226 - 450 V / > 10 kVA	3.81 mm	5.08 mm
		Peak working voltage:	226 - 400 V / 500 VA - 10 kVA	2.54 mm	2.54 mm

	Operating Voltage	Creepage distance for material group (CTI)*		
		I	II	IIIa & IIIb
UL 840 Table 9.1 Pollution degree 3 (alternate 36.9.3 UL 508C)	320 V	4.0 mm	4.5 mm	5.0 mm
	400 V	5.0 mm	5.6 mm	6.3 mm
UL 840 is similar to IEC 664-1	500 V	6.3 mm	7.1 mm	8.0 mm
UL 840 Table 9.1 Pollution degree 2 (alternate 36.9.3 UL 508C)	320 V	1.6 mm	2.2 mm	3.2 mm
	400 V	2.0 mm	2.8 mm	4.0 mm
	500 V	2.5 mm	3.6 mm	5.0 mm

	Overvoltage category	Rated Impulse withstand voltage peak	minimum Clearance (600 V)
	III	4.0 kV	3.0 mm
UL 840 is similar to IEC 664-1	IV	6.0 kV	5.5 mm
UL 840 Table 8.1 Pollution degree 2 (alternate 36.9.3 UL 508C)	II	2.5 kV	1.5 mm
	III	4.0 kV	3.0 mm
	IV	6.0 kV	5.5 mm

600 V

## Comparison of UL clearance and creepage distances for UL 600 Volt

				min. clearance	
UL 1059	minimum spacing (Table 8.1)	301 - 600 V		9.5 mm	12.7 mm
UL 508C	minimum spacing (Table 36.1)	151 - 300 V		9.5 mm	12.7 mm
UL 508C	minimum spacing for products with known controlled transient voltages (Table 36.3)	Peak working voltage:	451 - 900 V / > 10 kVA	7.62 mm	10.16 mm
		Peak working voltage:	451 - 900 V / 500 VA - 10 kVA	5.08 mm	5.08 mm

	Operating Voltage	Creepage distance for material group (CTI)*		
		I	II	IIIa & IIIb
UL 840 Table 9.1 Pollution degree 3 (alternate 36.9.3 UL 508C)	630 V	8.0 mm	9.0 mm	10.0 mm
	800 V	10.0 mm	11.0 mm	12.5 mm
UL 840 is similar to IEC 664-1	1000 V	12.5 mm	14.0 mm	16.0 mm
UL 840 Table 9.1 Pollution degree 2 (alternate 36.9.3 UL 508C)	630 V	3.2 mm	4.5 mm	6.3 mm
	800 V	4.0 mm	5.6 mm	8.0 mm
	1000 V	5.0 mm	7.1 mm	10.0 mm

	Overvoltage category	Rated Impulse withstand voltage peak	minimum Clearance (600 V)
	III	6.0 kV	5.5 mm
UL 840 is similar to IEC 664-1	IV	8.0 kV	8.0 mm
UL 840 Table 8.1 Pollution degree 2 (alternate 36.9.3 UL 508C)	II	4.0 kV	3.0 mm
	III	6.0 kV	5.5 mm
	IV	8.0 kV	8.0 mm

### Guideline: relationship between approvals

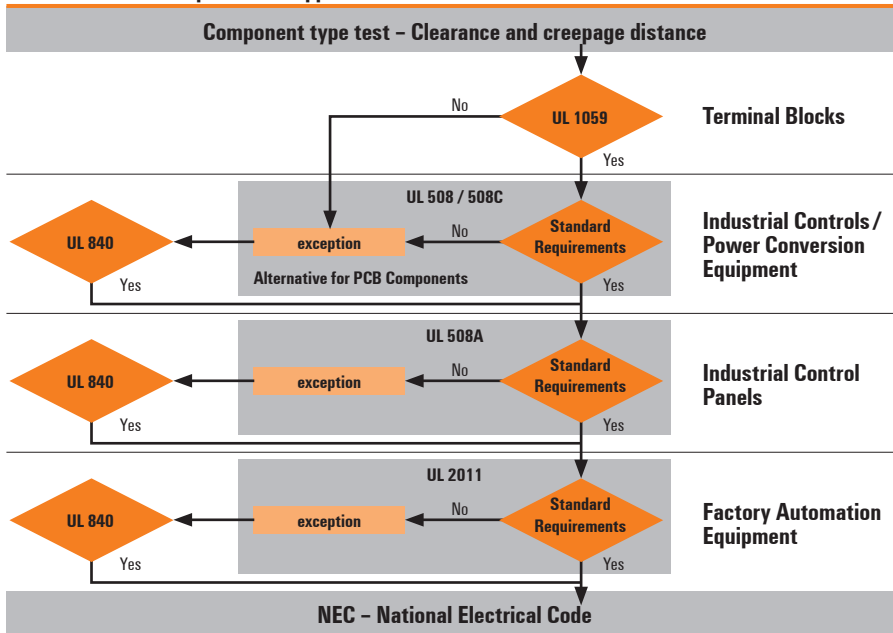

W

# Design-in recommendations: applications for 600 V in accordance with UL

Summary of the most important UL requirements:

- PCB components are approved to UL 1059 and are tested without a PCB or application environment.
- Applications are approved to UL 508 (or UL 508C Power Conversion Equipment, e.g. frequency converters).
- The application designer must refer to the application-related UL standards, not to UL 1059.
- UL 508C enables the use of field terminals approved to UL 1059 for 300 V to be used for 600 V applications under certain conditions.
- Weidmüller Powermate Range plug-in connectors and power terminals comply with the conditions and may be used for 600 V applications to UL 508C.
- For more detailed information, please refer to the drawing below.

## The approval for higher voltages to UL 508C / UL 840:

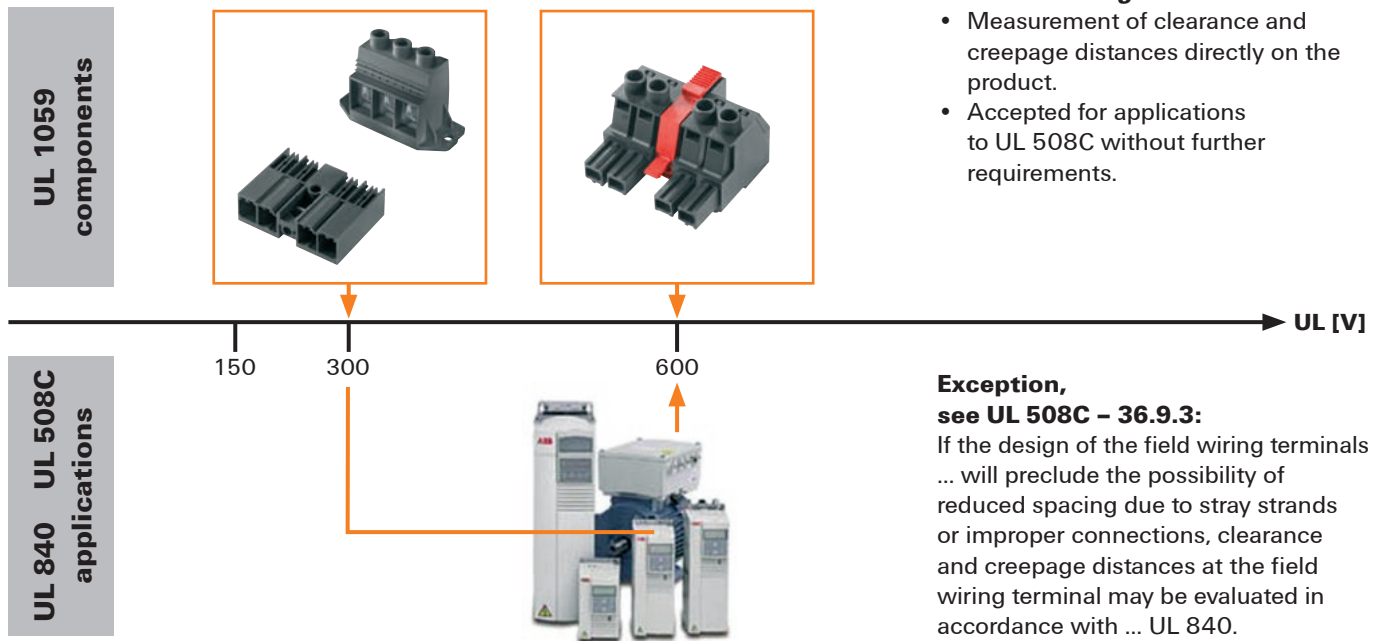

## Extract from UL 508C: (36.9 Spacings for drives evaluated in accordance with UL 840)

- 36.9.1 Other than as noted in 36.9.2 and 36.9.3, clearance and creepage distances are able to be evaluated in accordance with the requirements in the Standard for Insulation Coordination Including Clearance and Creepage Distances for Electrical Equipment, UL 840. See 36.9.4 for details on applying UL 840.
- 36.9.2 Clearances between an uninsulated live part and the walls of a metal enclosure, including fittings for conduit or armored cable, shall be in accordance with 36.2.2. The clearances shall be determined by physical measurement.
- 36.9.3 The clearance and creepage distance at field wiring terminals shall be in accordance with the requirements in 36.3.1. Exception: When the design of the field wiring terminals precludes the possibility of reduced spacing due to stray strands or improper wiring installation, then clearance and creepage distances at these terminals are able to be evaluated in accordance with the Standard for Insulation Coordination Including Clearance and Creepage Distances for Electrical Equipment, UL 840.

## Weidmüller connectors in the reflow soldering process

The PCB assembly process has undergone a fundamental change in recent years. The conventional through-hole mounting technology (Through Hole Technology, THT) has been increasingly replaced by surface mounting technology (SMT). The reasons for this was the increasing demands of miniaturisation, higher functional density and lower manufacturing costs. The progress made in the development of surface mounted devices (SMD), that allowed the development of the SMT manufacturing process in the first place has also played a role. SMT is now the accepted standard in PCB manufacturing. There are still some components, in the main electro-mechanical components like connectors or relays, which are not available in a SMD version, they are therefore mounted following the SMT process using the classical THT assembly onto the PCB. Weidmüller has developed a product range for the through hole reflow process (THR), that makes wired component parts usable in the SMT process and allows 100 % processing in the SMT production line.

Through-hole reflow is a process for linking THT components with the SMT reflow soldering process. In addition to just SMD assembly, the SMD components with THR can be placed onto the SMT printed-circuit board together with wired components and be soldered in the reflow process. The THR process was developed from the realisation that stable soldering connections are still necessary with heavy components such as coils or transformers, as well as wherever mechanical forces come to bear on the printed-circuit boards, (such as with connection terminals, plug-and-socket connectors or relay sockets). SMD soldered joints are less suited for heavy components under substantial mechanical stress.

A SMT compatible product is always a compromise between optimal SMT capability and the stability of the solder connection. THR ensures a stable connection of the THT components to the PCB using the push-through pins. At the same time this ensures 100 % compatibility with the SMT process.

### Benefits of THR:

- stable connection to the PCB
- only one soldering process
- No longer a need for hand or wave soldering
- automatic assembly
- lower production costs



In order to use THR components in the SMT process, they must meet certain requirements.

### Stability in a new dimension

Our pin headers are made of glass-fibre reinforced LCP (liquid crystal polymers). This guarantees a high level of shape stability. The material's excellent temperature characteristics and the built-in grid space are excellent for the SMT process as well as "lead-free soldering".

### The benefits:

- High temperature resistance
- Melting point of 335 °C
- Free from halogens
- Low thermal expansion coefficient
- Should be processed without drying

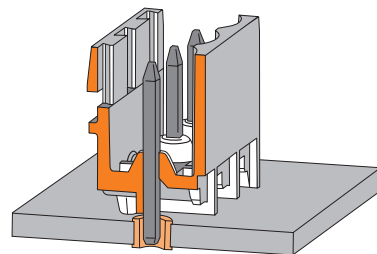

### Remains true even to the pitches

Weidmüller's makes its male headers SL-SMT from LCP (liquid crystal polymer) to prevent undesirable dimensional changes caused by water absorption during storage. This ensures the highest pitch accuracy, even at high pin counts and secures the placement process.

# The basis for high quality, reliability and efficiency

## THR technology

THR soldering process is the processing of components that are inserted through a hole in the PCB and then soldered along with the other SMT components. In this technology the components themselves must be able to withstand the higher temperatures of the SMT process.

## Through hole technology in the SMT process

The placement process of PCBs has undergone a fundamental change in recent years. The conventional through hole mounting technique (THT) was increasingly replaced by the surface mounting process (SMT). SMT is now the accepted standard for PCB manufacture.

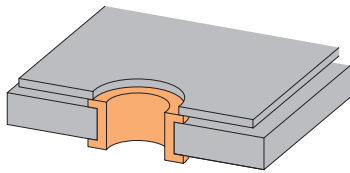

## "Design in" – "Design out" from experience

Standard-process parameters help when drafting the printed-circuit board and template layout. Weidmüller recommends pin headers with short pins of 1.5 mm length. The following parameters have to be determined for the printed-circuit board design:

- Mounting hole diameter
- Soldering terminal diameter
- Stencil hole diameter  
(with sufficient paste filling)
- Stencil hole diameter  
(with insufficient paste filling)

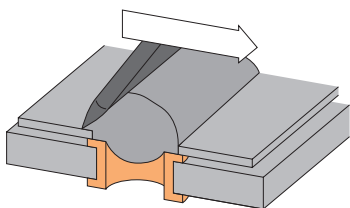

## Paste printing – low volume in the best shape

Weidmüller SL-SMT pin headers have short octagonal pins with a chamfered pin end to keep the required paste volume as low as possible. Due to the pin length of just 1.5 mm for standard PCBs with a 1.6 mm thickness, an optimal solder joint shape can be achieved with a paste filling of approximately 90 %.

In addition, most normal one layer stencils for fine pitch techniques and the standard process parameters for squeegee speed and printing can be used.

Unbeatable advantage: the paste is pushed out of the placement hole during the placement process.

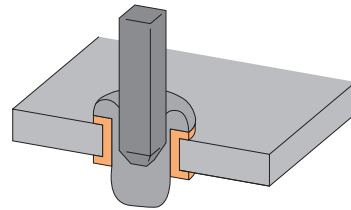

## Assembly – short pins – great performance

Due to the shorter pins of 1.5 mm, you can have a higher packing volume for tape on reel or tray. This is also supported on the one side by the fact that SL-SMT male headers have a low profile, and also the reduced packaging height. Standard and anti-static packaging also allows fully automatic assembly with the commonly available Pick & Place systems. Outstanding advantages are offered by the short pins of the SL-SMT and the optimising of the travel height as well as the precision of the pin end position. Additionally, collisions between the components and the PCB can be completely avoided. At the same time, the SMT optimised male headers from Weidmüller increase the assembly strength due to their low weight.

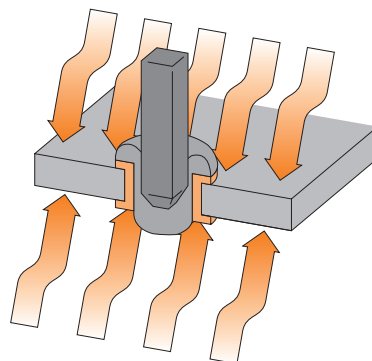

### Reflow solder – the material of the future

High temperature resistant, halogen free insulating material LCP (Liquid Crystal Polymer) has a melting point of 335 °C. It not only has high dimensional stability, but also good resistance to the heat of soldering. Our SL-SMT male headers made from LCP are future proof, and can be used in lead-free solder processes. This leads to another key advantage of LCP: though its low thermal expansion coefficient, the bending of an assembly following the soldering process is avoided.

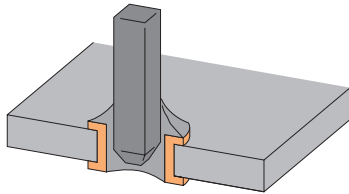

### Quality control – control is better

To determine the quality of the solder joints of the THR components with short or long pins, Weidmüller has chosen the quick and simple checking using optical inspection, or X-ray examination. This meets the requirements of the internationally recognised norms and standards.

Our specially designed SL-SMT male headers allow optical inspection of the primary side of a PCB even for varieties with 180° outlet direction. This meets the requirements for in-process quality control.



# Design recommendations for the through-hole reflow process

## Solder paste volume and filling degree for 1.2 mm pin diameter.

The volume of paste and hence the degree of filling of the solder paste in the paste printing technology is critical for optimum soldering results in the SMT process. We recommend determining the quantity of solder paste as follows:

### Volume of paste (or rather, degree of filling):

for solder joint filling and solder joint form within the tolerances to IPC-A610

Male conn. (open and closed):	2 to 8 poles	9 to 24 poles
Male conn. (solder flange LF):	-	2 to 24 poles
Recommended finished hole I.D. *1):	$d_i = 1,4^{+0,1}$ mm	$d_i = 1,5^{+0,1}$ mm
	Paste volume $V_p$ [mm <sup>3</sup> ] / filling level $f_p$ [%] after stencil print	
Minimum solder joint shape	2,4 mm <sup>3</sup> / 70 %	3,1 mm <sup>3</sup> / 85 %
Optimum solder joint shape	2,9 mm <sup>3</sup> / 90 %	3,5 mm <sup>3</sup> / 100 %

### Valid with the following parameters for all SL-SMT variations:

#### Male connector:

Pin length = **L** [mm] = 1,5<sup>-0,3</sup>  
 Pin diameter = **d** [mm] = 1,2

#### PCB:

Thickness = **H** [mm] = 1,6  
 Placement hole = metallised  
 Placement hole inner diameter ID = **d<sub>i</sub>** [mm] = see table<sup>1)</sup>  
 Placement hole outer diameter OD = **d<sub>A</sub>** [mm] = 2,3  
 Positioning tolerance to IEC 326-3 = very fine

#### Stencil:

Thickness = **D<sub>s</sub>** [µm] = 120 - 180  
 Stencil hole diameter = **d<sub>s</sub>** [mm] = 2,1<sup>2)</sup>

#### Solder paste:

Solder paste particle size [µm] = 20 - 40 = Type 3  
 Evaporation volume of solder paste [%] = approx. 50

#### Process:

Stencil print technology = squeegee print, single  
 Filling level in placement hole = **f<sub>p</sub>** [%] = see table  
 Technology for automatic assembly = pick&place  
 Temperature profile = to EN 61760-1

<sup>1)</sup> Tolerances for components, PCBs and automatic machines must be taken into account.

<sup>2)</sup> Stencil hole diameter approx. 10 % smaller than placement hole outer diameter **d<sub>A</sub>**

Recommendations for S2C-SMT and SC-SMT 3.81 see:

<http://catalog.weidmueller.com>

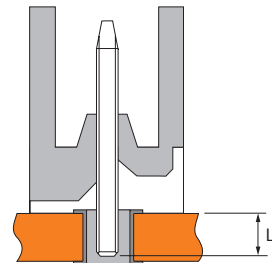

Male connector parameters

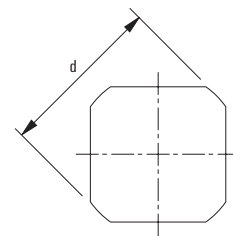

Pin cross-section

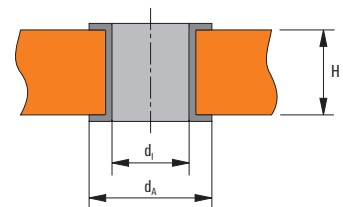

PCB parameters

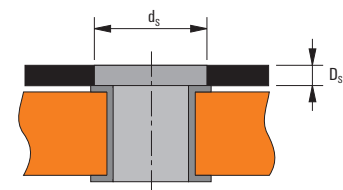

Stencil parameters

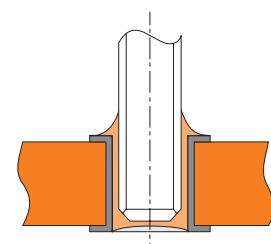

Optimum solder joint form

## Quality control

Quality control completes the SMT production process. The goal in this process step is, using appropriate techniques, to check the quality of the solder joints of the THR components with short or long pins quickly and easily. The quality control rules for the THR solder technique are the same as for flow or wave soldering of THT components.

### Control process:

The process quality control can be achieved by using various technologies. Currently optical or X-ray examination is mostly used. The optical examination evaluates the shape, reflectivity and colour of the solder joints.

In the manual process, a magnifying glass or microscope is used, in the automatic process a computer controlled camera and software based image analysis is used.

In X-ray inspection, however, radiographic evaluation using automated X-ray microscopy is carried out. An important control factor are destructive testing in addition to the inspection process. Random samples are taken and used to verify measurable quantities:

- Analysis of the filling behaviour by cutting through the solder joint
- Mechanical testing of the pin pull-out resistance from the contacts

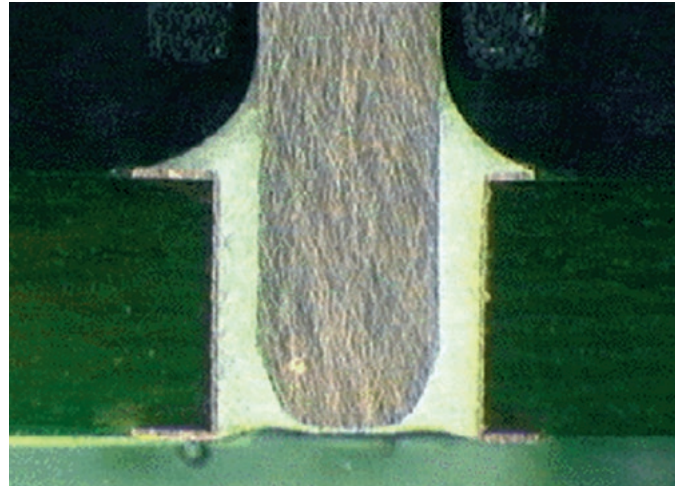

Cutting through the THR solder joint with the short pin

**Norms and standards:**

To make quality control more objective, norms and standards have been introduced over the recent years. In addition to other acceptance criteria for the manufacturing of electronic components, the quality control assessment criteria of the IPC-A-610E Norm are globally recognised.

According to IPC-A-610E quality requirements, THR solder joints are divided into three classes. For industrial applications where high power demands are made, Class 3 is the usual requirement. The following values are set for the five assessment criteria:

- The primary side solder wetting coverage (i.e. the insertion side from the view of the component), connection and sleeve should not be less than 270°.
- The vertical solder filling must be at least 75 %.

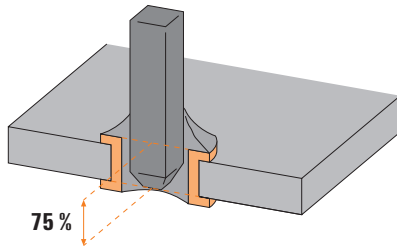
**Measuring the filling level of through hole solder joints according to IPC-A-610E**

- The secondary side solder wetting coverage (i.e. the underside from the view of the component) should not be less than 330°.
- Solder wetting of the solder pads (i.e. remains of the original ring of the THR solder joint) on the primary side is to be 0 %.
- Solder wetting of the solder pads on the secondary side must be at least 75 %.

These standards produce many demands on the wired components in the quality control. It should be noted that, in the THR process, there are typically two different construction types:

- Short pins when compared to the PCB thickness
- Longer pins when compared to the PCB thickness (about 1 to 1.5 mm protrusion)

For short pin construction there are the following requirements:

- The solder joints on the primary side of the PCB must be visible.
- For components with pins under the insulating body, the height of the component over the PCB must be sufficient to allow optical inspection.

For long pins, there are the following requirements:

- The solder joints on the secondary side must be visible.
- Solder joints on the primary side are, however, not required.

Additionally, in destructive testing with THR components there are requirements placed on the PCB itself. To control the quality of the PCB construction, the pull out strength of the solder pins from the solder joint is tested.

**Required pull out strength:**

- with short pins: approximately > 150 N.
- for long pins with a solder meniscus on the primary and secondary sides: approximately 220 N.

**In comparison,**

For surface connections for SMD components the required pull-out strength is only about 15 - 20 N.

According to IPC-A-610 Revision E-2010, section 7.3.3 the use of pins that are shorter than the PCB thickness is permissible in principle.

## OMNIMATE® Signal SMD goes one step further in the development of a conventional THR solder connection

OMNIMATE® Signal terminals are now available as SMD components. Surface-mount connectors are increasingly being incorporated into standard SMT processes in electronic module production. Solder pad design and co-planarity produce optimum holding forces on the printed circuit board and guarantee a secure connection.

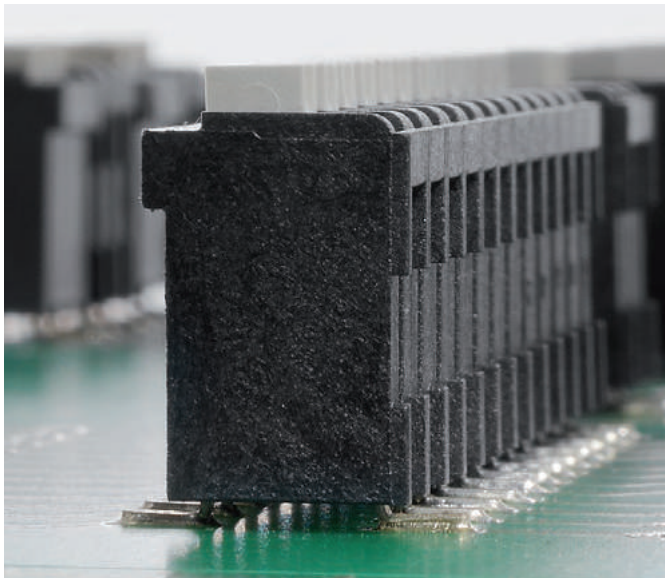
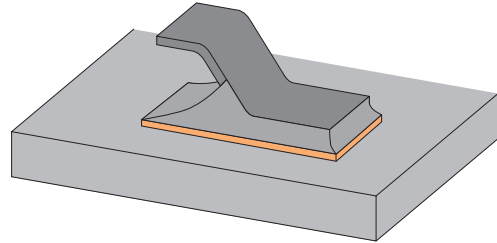

LSF-SMD

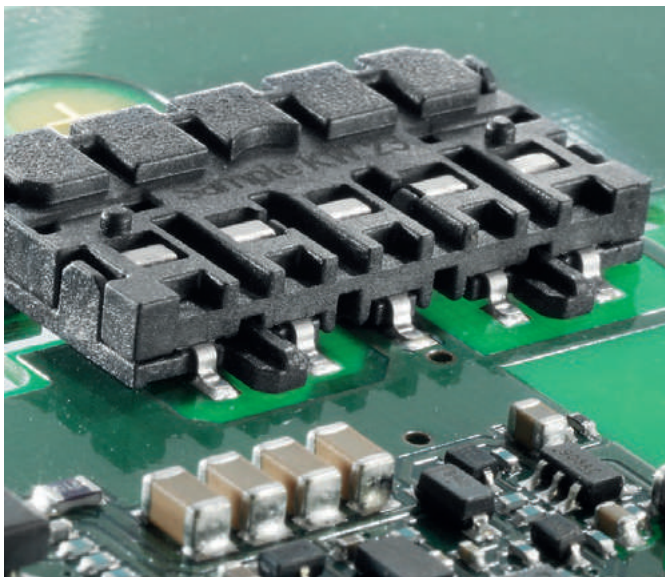

CH20M bus contact block

The SMD PCB terminal, LSF-SMD, meets the needs of fully-automated PCB manufacturing processes. This genuine SMD variant is a valuable addition to the existing range of reflow-capable LSF SMT PCB terminals, with THR soldering processes from Weidmüller. Applications on glass, ceramic or aluminium composite PCBs can now also be safely connected.

### Benefits of the LSF for surface mounting

- All of our tape-on-reel product is supplied on industry-standard reels. Enhanced pick-and-place pads guarantee reliable positioning on the printed circuit board.
- With two solder pins per pole, the LSF-SMD printed-circuit board clamp meets the high demands made of mechanical fixing on the printed-circuit board without additional fastening flanges according to IPC-A-610 of class 2.
- Additional function space on rear of PCB. Use of our SMD products eliminates the need to through connect THR components, giving you more function space for two-sided mounting on the rear of the PCB with design-in.

SMD plug-in connectors are also used in the modular CH20M Housing. The bus contact block is resistant to high temperatures and, with its gold-plated springs, provides a secure and permanent connection to the system bus.

# Conversion table

## AWG to mm<sup>2</sup> conductors

**AWG** is the abbreviation for “**A**merican **W**ire **G**auge”. This designation bears no resemblance to the actual cross-section of the conductor.

The relationship between AWG and mm<sup>2</sup> is shown in the following table.

AWG	mm <sup>2</sup>
28	0.08
26	0.13
24	0.21
22	0.32
20	0.52
19	0.65
18	0.82
17	1.04
16	1.31
15	1.65
14	2.08
13	2.63
12	3.31
11	4.17
10	5.26
9	6.63
8	8.37
7	10.55
6	13.30
5	16.77
4	21.15
3	26.67
2	33.63
1	42.41
0	53.48



# Index

---

<b>Index</b>	Index Type	X.2
	Index Order No.	X.28
	Addresses worldwide	X.54

---





Type	Order No.	Page	Type	Order No.	Page	Type	Order No.	Page	Type	Order No.	Page
BCZ 3.81/09/180FZE SN OR BX	1236800000	F.51	BCZ 3.81/20/180LR SN OR BX	2442510000	F.49	BL 3.50/06/90F SN OR BX	1639050000	E.51	BL 3.50/21/90 SN OR BX	1638740000	E.50
BCZ 3.81/09/180LR SN OR BX	2442390000	F.49	BCZ 3.81/20/180LRZE SN OR BX	2442180000	F.51	BL 3.50/07/180 SN OR BX	1597410000	E.48	BL 3.50/21/90F SN OR BX	1639200000	E.51
BCZ 3.81/09/180LRZE SN OR BX	2442300000	F.51	BCZ 3.81/20/180ZE SN OR BX	1236470000	F.50	BL 3.50/07/180F SN OR BX	1606690000	E.49	BL 3.50/22/180 SN OR BX	1620340000	E.48
BCZ 3.81/09/180ZE SN OR BX	1236320000	F.50	BHZ 5.00/02/90LH BK/BL	1069330000	N.19	BL 3.50/07/180LR SN OR BX	1531040000	E.49	BL 3.50/22/180F SN OR BX	1620810000	E.49
BCZ 3.81/09/270 SN OR BX	1940260000	F.53	BHZ 5.00/02/90LH BK/BK	1069330000	N.19	BL 3.50/07/270 SN OR BX	1639520000	E.51	BL 3.50/22/180F SN OR BX	1639670000	E.51
BCZ 3.81/09/270F SN OR BX	1940530000	F.53	BHZ 5.00/02/90LH BK/BL	1069360000	N.33	BL 3.50/07/270F SN OR BX	1639980000	E.51	BL 3.50/22/270F SN OR BX	1640130000	E.51
BCZ 3.81/09/90 SN OR BX	1939900000	F.52	BHZ 5.00/02/90LH BK/BL	1069360000	N.33	BL 3.50/07/90 SN OR BX	1638600000	E.50	BL 3.50/22/90 SN OR BX	1638750000	E.50
BCZ 3.81/09/90F SN OR BX	1940050000	F.53	BHZ 5.00/02/90LH BK/DR	1063260000	N.19	BL 3.50/07/90F SN OR BX	1639060000	E.51	BL 3.50/22/90F SN OR BX	1639210000	E.51
BCZ 3.81/10/180 SN OR BX	1940810000	F.48	BHZ 5.00/02/90LH BK/DR	1063260000	N.19	BL 3.50/08/180 SN OR BX	1597420000	E.48	BL 3.50/23/180 SN OR BX	1620350000	E.48
BCZ 3.81/10/180F SN OR BX	1941090000	F.49	BHZ 5.00/03/90LH BK/BK	1069340000	N.21	BL 3.50/08/180F SN OR BX	1606700000	E.49	BL 3.50/23/180F SN OR BX	1620820000	E.49
BCZ 3.81/10/180FZE SN OR BX	1236610000	F.51	BHZ 5.00/03/90LH BK/BL	1069340000	N.21	BL 3.50/08/180LR SN OR BX	1531050000	E.49	BL 3.50/23/270 SN OR BX	1639680000	E.51
BCZ 3.81/10/180LR SN OR BX	2442400000	F.49	BHZ 5.00/03/90LH BK/BL	1069370000	N.21	BL 3.50/08/270 SN OR BX	1639530000	E.51	BL 3.50/23/270F SN OR BX	1640140000	E.51
BCZ 3.81/10/180LRZE SN OR BX	2442240000	F.51	BHZ 5.00/03/90LH BK/BL	1069370000	N.21	BL 3.50/08/270F SN OR BX	1639990000	E.51	BL 3.50/23/90 SN OR BX	1638760000	E.50
BCZ 3.81/10/180ZE SN OR BX	1236330000	F.50	BHZ 5.00/03/90LH BK/DR	1063270000	N.21	BL 3.50/08/90 SN OR BX	1638610000	E.50	BL 3.50/23/90F SN OR BX	1639220000	E.51
BCZ 3.81/10/270 SN OR BX	1940270000	F.53	BHZ 5.00/03/90LH BK/DR	1063270000	N.21	BL 3.50/08/90F SN OR BX	1639070000	E.51	BL 3.50/24/180 SN OR BX	1620360000	E.48
BCZ 3.81/10/270F SN OR BX	1940540000	F.53	BHZ 5.00/04/90LH BK/BL	1069350000	N.32	BL 3.50/09/180 SN OR BX	1597430000	E.48	BL 3.50/24/180F SN OR BX	1620830000	E.49
BCZ 3.81/10/270FZE SN OR BX	1236620000	F.51	BHZ 5.00/04/90LH BK/BK	1069350000	N.32	BL 3.50/09/180F SN OR BX	1606710000	E.49	BL 3.50/24/270 SN OR BX	1639690000	E.51
BCZ 3.81/10/90 SN OR BX	1939910000	F.52	BHZ 5.00/04/90LH BK/BL	1069350000	N.25	BL 3.50/09/180LR SN OR BX	1531070000	E.49	BL 3.50/24/270F SN OR BX	1640150000	E.51
BCZ 3.81/10/90F SN OR BX	1940060000	F.53	BHZ 5.00/04/90LH BK/BK	1069350000	N.25	BL 3.50/09/270 SN OR BX	1639540000	E.51	BL 3.50/24/90 SN OR BX	1638770000	E.50
BCZ 3.81/11/180 SN OR BX	1940820000	F.48	BHZ 5.00/04/90LH BK/BK	1069350000	N.33	BL 3.50/09/270F SN OR BX	1640000000	E.51	BL 3.50/24/90F SN OR BX	1639230000	E.51
BCZ 3.81/11/180F SN OR BX	1941100000	F.49	BHZ 5.00/04/90LH BK/BL	1069380000	N.23	BL 3.50/09/90 SN OR BX	1638620000	E.50	BL 3.50/25/180 SN OR BX	1620370000	E.48
BCZ 3.81/11/180FZE SN OR BX	1236620000	F.51	BHZ 5.00/04/90LH BK/BL	1069380000	N.23	BL 3.50/09/90F SN OR BX	1639080000	E.51	BL 3.50/25/180F SN OR BX	1620840000	E.49
BCZ 3.81/11/180LR SN OR BX	2442350000	F.49	BHZ 5.00/04/90LH BK/BL	1069380000	N.27	BL 3.50/10/180 SN OR BX	1597440000	E.48	BL 3.50/25/270 SN OR BX	1639690000	E.51
BCZ 3.81/11/180LRZE SN OR BX	2442220000	F.51	BHZ 5.00/04/90LH BK/BL	1069380000	N.33	BL 3.50/10/180F SN OR BX	1606720000	E.49	BL 3.50/25/270F SN OR BX	1640160000	E.51
BCZ 3.81/11/180ZE SN OR BX	1236340000	F.50	BHZ 5.00/04/90LH BK/DR	1063280000	N.23	BL 3.50/10/180LR SN OR BX	1531080000	E.49	BL 3.50/25/90 SN OR BX	1638780000	E.50
BCZ 3.81/11/270 SN OR BX	1940280000	F.53	BHZ 5.00/04/90LH BK/DR	1063280000	N.23	BL 3.50/10/180LR SN OR BX	1531080000	E.49	BL 3.50/25/90F SN OR BX	1639240000	E.51
BCZ 3.81/11/270F SN OR BX	1940550000	F.53	BHZ 5.00/04/90LH BK/DR	1063280000	N.27	BL 3.50/10/270 SN OR BX	1639550000	E.51	BL 3.50/25/90F SN OR BX	1639300000	E.41
BCZ 3.81/11/90 SN OR BX	1939920000	F.52	BHZ 5.00/04/90LH BK/DR	1063280000	N.32	BL 3.50/10/270F SN OR BX	1640010000	E.51	BL 3.50/25/180 SN OR BX	1620380000	E.48
BCZ 3.81/11/90F SN OR BX	1940070000	F.53	BL 3.50 AH03 BK BX	1745680000	E.48	BL 3.50/10/270F SN OR BX	1640010000	E.51	BL 3.50/25/180F SN OR BX	1620850000	E.49
BCZ 3.81/12/180 SN OR BX	1940830000	F.48	BL 3.50 AH03 BK BX	1745680000	E.48	BL 3.50/11/90 SN OR BX	1639090000	E.51	BL 3.50/25/180F SN OR BX	1639690000	E.51
BCZ 3.81/12/180F SN OR BX	1941110000	F.49	BL 3.50 AH04 BK BX	1745590000	E.48	BL 3.50/11/180 SN OR BX	1597450000	E.48	BL 3.50/25/180F SN OR BX	1639300000	E.41
BCZ 3.81/12/180FZE SN OR BX	1236630000	F.51	BL 3.50 AH04 BK BX	1745590000	E.48	BL 3.50/11/180F SN OR BX	1606730000	E.49	BL 3.50/25/180F SN OR BX	1639300000	E.41
BCZ 3.81/12/180LR SN OR BX	2442410000	F.49	BL 3.50 AH05 BK BX	1745600000	E.48	BL 3.50/11/180LR SN OR BX	1531090000	E.49	BL 3.50/25/180F SN OR BX	1639300000	E.41
BCZ 3.81/12/180LRZE SN OR BX	2442270000	F.51	BL 3.50 AH05 BK BX	1745600000	E.48	BL 3.50/11/270 SN OR BX	1639560000	E.51	BL 3.50/25/180F SN OR BX	1639300000	E.41
BCZ 3.81/12/180ZE SN OR BX	1236370000	F.50	BL 3.50 AH06 BK BX	1745610000	E.48	BL 3.50/11/270F SN OR BX	1640020000	E.51	BL 3.50/25/180F SN OR BX	1639300000	E.41
BCZ 3.81/12/270 SN OR BX	1940290000	F.53	BL 3.50 AH06 BK BX	1745610000	E.48	BL 3.50/11/270 SN OR BX	1638640000	E.50	BL 3.50/25/180F SN OR BX	1639300000	E.41
BCZ 3.81/12/270F SN OR BX	1940560000	F.53	BL 3.50 AH07 BK BX	1745620000	E.48	BL 3.50/11/270 SN OR BX	1638640000	E.50	BL 3.50/25/180F SN OR BX	1639300000	E.41
BCZ 3.81/12/90 SN OR BX	1939930000	F.52	BL 3.50 AH07 BK BX	1745620000	E.48	BL 3.50/11/90F SN OR BX	1639100000	E.51	BL 3.50/25/180F SN OR BX	1639300000	E.41
BCZ 3.81/12/90F SN OR BX	1940080000	F.53	BL 3.50 AH08 BK BX	1745630000	E.48	BL 3.50/12/180 SN OR BX	1597460000	E.48	BL 3.50/25/180F SN OR BX	1639300000	E.41
BCZ 3.81/13/180 SN OR BX	1940840000	F.48	BL 3.50 AH08 BK BX	1745630000	E.48	BL 3.50/12/180F SN OR BX	1606740000	E.49	BL 3.50/25/180F SN OR BX	1639300000	E.41
BCZ 3.81/13/180F SN OR BX	1941120000	F.49	BL 3.50 AH09 BK BX	1745640000	E.48	BL 3.50/12/180LR SN OR BX	1531100000	E.49	BL 3.50/25/180F SN OR BX	1639300000	E.41
BCZ 3.81/13/180FZE SN OR BX	1236640000	F.51	BL 3.50 AH09 BK BX	1745640000	E.48	BL 3.50/12/270 SN OR BX	1639570000	E.51	BL 3.50/25/180F SN OR BX	1639300000	E.41
BCZ 3.81/13/180LR SN OR BX	2442460000	F.49	BL 3.50 AH09 BK BX	1745640000	E.48	BL 3.50/12/270F SN OR BX	1640030000	E.51	BL 3.50/25/180F SN OR BX	1639300000	E.41
BCZ 3.81/13/180LRZE SN OR BX	2442190000	F.51	BL 3.50 AH10 BK BX	1745650000	E.48	BL 3.50/12/270 SN OR BX	1638650000	E.50	BL 3.50/25/180F SN OR BX	1639300000	E.41
BCZ 3.81/13/180ZE SN OR BX	1236380000	F.50	BL 3.50 AH10 BK BX	1745650000	E.48	BL 3.50/12/90F SN OR BX	1639100000	E.51	BL 3.50/25/180F SN OR BX	1639300000	E.41
BCZ 3.81/13/270 SN OR BX	1940300000	F.53	BL 3.50 AH11 BK BX	1745660000	E.48	BL 3.50/13/180 SN OR BX	1597470000	E.48	BL 3.50/25/180F SN OR BX	1639300000	E.41
BCZ 3.81/13/270F SN OR BX	1940570000	F.53	BL 3.50 AH11 BK BX	1745660000	E.48	BL 3.50/13/180F SN OR BX	1606750000	E.49	BL 3.50/25/180F SN OR BX	1639300000	E.41
BCZ 3.81/13/90 SN OR BX	1939940000	F.52	BL 3.50 AH12 BK BX	1745670000	E.48	BL 3.50/13/180LR SN OR BX	1531110000	E.49	BL 3.50/25/180F SN OR BX	1639300000	E.41
BCZ 3.81/13/90F SN OR BX	1940090000	F.53	BL 3.50 AH12 BK BX	1745670000	E.48	BL 3.50/13/270 SN OR BX	1639580000	E.51	BL 3.50/25/180F SN OR BX	1639300000	E.41
BCZ 3.81/14/180 SN OR BX	1940850000	F.48	BL 3.50 AH13 BK BX	1745680000	E.48	BL 3.50/13/270 SN OR BX	1639580000	E.51	BL 3.50/25/180F SN OR BX	1639300000	E.41
BCZ 3.81/14/180F SN OR BX	1941130000	F.49	BL 3.50 AH13 BK BX	1745680000	E.48	BL 3.50/13/270F SN OR BX	1640040000	E.51	BL 3.50/25/180F SN OR BX	1639300000	E.41
BCZ 3.81/14/180FZE SN OR BX	1236670000	F.51	BL 3.50 AH14 BK BX	1745690000	E.48	BL 3.50/13/90 SN OR BX	1638660000	E.50	BL 3.50/25/180F SN OR BX	1639300000	E.41
BCZ 3.81/14/180LR SN OR BX	2442420000	F.49	BL 3.50 AH14 BK BX	1745690000	E.48	BL 3.50/14/180 SN OR BX	1597480000	E.48	BL 3.50/25/180F SN OR BX	1639300000	E.41
BCZ 3.81/14/180LRZE SN OR BX	2442280000	F.51	BL 3.50 AH15 BK BX	1745700000	E.48	BL 3.50/14/180F SN OR BX	1606760000	E.49	BL 3.50/25/180F SN OR BX	1639300000	E.41
BCZ 3.81/14/180ZE SN OR BX	1236390000	F.50	BL 3.50 AH15 BK BX	1745700000	E.48	BL 3.50/14/180LR SN OR BX	1531120000	E.49	BL 3.50/25/180F SN OR BX	1639300000	E.41
BCZ 3.81/14/270 SN OR BX	1940310000	F.53	BL 3.50 AH16 BK BX	1745710000	E.48	BL 3.50/14/270 SN OR BX	1639590000	E.51	BL 3.50/25/180F SN OR BX	1639300000	E.41
BCZ 3.81/14/270F SN OR BX	1940580000	F.53	BL 3.50 AH16 BK BX	1745710000	E.48	BL 3.50/14/270F SN OR BX	1640050000	E.51	BL 3.50/25/180F SN OR BX	1639300000	E.41
BCZ 3.81/14/90 SN OR BX	1939950000	F.52	BL 3.50 ZE03 BK BX	1627820000	E.12	BL 3.50/14/90 SN OR BX	1638670000	E.50	BL 3.50/25/180F SN OR BX	1639300000	E.41
BCZ 3.81/14/90F SN OR BX	1940100000	F.53	BL 3.50 ZE03 BK BX	1627820000	E.12	BL 3.50/14/90F SN OR BX	1639130000	E.51	BL 3.50/25/180F SN OR BX	1639300000	E.41
BCZ 3.81/15/180 SN OR BX	1940860000	F.48	BL 3.50 ZE03 BK BX	1627820000	E.12	BL 3.50/15/180 SN OR BX	1597490000	E.48	BL 3.50/25/180F SN OR BX	1639300000	E.41
BCZ 3.81/15/180F SN OR BX	1940860000	F.48	BL 3.50 ZE03 BK BX	1627820000	E.12	BL 3.50/15/180F SN OR BX	1606770000	E.49	BL 3.50/25/180F SN OR BX	1639300000	E.41
BCZ 3.81/15/180FZE SN OR BX	1941140000	F.49	BL 3.50 ZE03 BK BX	1627820000	E.12	BL 3.50/15/180LR SN OR BX	1531130000	E.49	BL 3.50/25/180F SN OR BX	1639300000	E.41
BCZ 3.81/15/180LR SN OR BX	2442360000	F.49	BL 3.50 ZE03 BK BX	1627820000	E.12	BL 3.50/15/270 SN OR BX	1639600000	E.51	BL 3.50/25/180F SN OR BX	1639300000	E.41
BCZ 3.81/15/180LRZE SN OR BX	2442430000	F.49	BL 3.50 ZE08 BK BX	1627830000	E.12	BL 3.50/15/270F SN OR BX	1640060000	E.51	BL 3.50/25/180F SN OR BX	1639300000	E.41
BCZ 3.81/15/180ZE SN OR BX	1236400000	F.51	BL 3.50 ZE08 BK BX	1627830000	E.12	BL 3.50/15/90 SN OR BX	1638680000	E.50	BL 3.50/25/180F SN OR BX	1639300000	E.41
BCZ 3.81/15/270 SN OR BX	1940320000	F.53	BL 3.50 ZE08 BK BX	1627830000	E.12	BL 3.50/15/90F SN OR BX	1639140000	E.51	BL 3.50/25/180F SN OR BX	1639300000	E.41
BCZ 3.81/15/270F SN OR BX	1940590000	F.53	BL 3.50 ZE08 BK BX	1627830000	E.12	BL 3.50/16/180 SN OR BX	1597500000	E.48	BL 3.50/25/180F SN OR BX	1639300000	E.41
BCZ 3.81/15/90 SN OR BX	1939960000	F.52	BL 3.50/02/180 SN OR BX	1597360000	E.48	BL 3.50/16					

Table with columns: Type, Order No., Page, Type, Order No., Page, Type, Order No., Page, Type, Order No., Page. Contains multiple columns of data for various product types and their corresponding order numbers and page references.



Type	Order No.	Page	Type	Order No.	Page	Type	Order No.	Page	Type	Order No.	Page
BLZ/SL KO BK BX	1545710000	G.82	BLZ/SL KO OR BX	1573010000	K.84	BLZP 5.00HC/14/180 SN OR BX	1954370000	G.40	BLZP 5.08HC/03/180 SN OR BX	1943590000	G.104
BLZ/SL KO BK BX	1545710000	G.84	BLZ/SL KO OR BX	1573010000	K.86	BLZP 5.00HC/14/180F SN OR BX	1955680000	G.41	BLZP 5.08HC/03/180F SN OR BX	1944100000	G.105
BLZ/SL KO BK BX	1545710000	G.86	BLZ/SL KO OR BX	1573010000	K.92	BLZP 5.00HC/14/180L SN OR BX	1956250000	G.41	BLZP 5.08HC/03/180L SN OR BX	1944840000	G.105
BLZ/SL KO BK BX	1545710000	G.88	BLZP 5.00HC/02/180 SN OR BX	1954490000	G.40	BLZP 5.00HC/14/270 SN OR BX	1958760000	G.44	BLZP 5.08HC/03/225 SN OR BX	1946260000	G.110
BLZ/SL KO BK BX	1545710000	G.90	BLZP 5.00HC/02/180F SN OR BX	1955800000	G.41	BLZP 5.00HC/14/270F SN OR BX	1959410000	G.45	BLZP 5.08HC/03/225F SN OR BX	1945760000	G.111
BLZ/SL KO BK BX	1545710000	G.92	BLZP 5.00HC/02/180L SN OR BX	1956370000	G.41	BLZP 5.00HC/14/270L SN OR BX	1960840000	G.45	BLZP 5.08HC/03/270 SN OR BX	1948800000	G.108
BLZ/SL KO BK BX	1545710000	G.94	BLZP 5.00HC/02/270 SN OR BX	1958870000	G.44	BLZP 5.00HC/14/90 SN OR BX	1958060000	G.42	BLZP 5.08HC/03/270F SN OR BX	1950320000	G.109
BLZ/SL KO BK BX	1545710000	G.96	BLZP 5.00HC/02/270F SN OR BX	1960460000	G.45	BLZP 5.00HC/14/90F SN OR BX	1959350000	G.43	BLZP 5.08HC/03/270L SN OR BX	1947540000	G.109
BLZ/SL KO BK BX	1545710000	G.98	BLZP 5.00HC/02/270L SN OR BX	1960960000	G.45	BLZP 5.00HC/15/180 SN OR BX	1954360000	G.40	BLZP 5.08HC/03/90 SN OR BX	1948010000	G.106
BLZ/SL KO BK BX	1545710000	G.99	BLZP 5.00HC/02/90 SN OR BX	1958300000	G.42	BLZP 5.00HC/15/180F SN OR BX	1955670000	G.41	BLZP 5.08HC/03/90F SN OR BX	1949810000	G.107
BLZ/SL KO BK BX	1545710000	G.100	BLZP 5.00HC/02/90F SN OR BX	1959520000	G.43	BLZP 5.00HC/15/180L SN OR BX	1956240000	G.41	BLZP 5.08HC/03/90L SN OR BX	1907260000	G.107
BLZ/SL KO BK BX	1545710000	G.102	BLZP 5.00HC/03/180 SN OR BX	1954480000	G.40	BLZP 5.00HC/15/270 SN OR BX	1958750000	G.44	BLZP 5.08HC/04/180 SN OR BX	1943600000	G.104
BLZ/SL KO BK BX	1545710000	G.104	BLZP 5.00HC/03/180F SN OR BX	1955790000	G.41	BLZP 5.00HC/15/270F SN OR BX	1959400000	G.45	BLZP 5.08HC/04/180F SN OR BX	1944110000	G.105
BLZ/SL KO BK BX	1545710000	G.106	BLZP 5.00HC/03/180L SN OR BX	1956360000	G.41	BLZP 5.00HC/15/270L SN OR BX	1960830000	G.45	BLZP 5.08HC/04/180L SN OR BX	1944850000	G.105
BLZ/SL KO BK BX	1545710000	G.108	BLZP 5.00HC/03/270 SN OR BX	1958860000	G.44	BLZP 5.00HC/15/90 SN OR BX	1958040000	G.42	BLZP 5.08HC/04/225 SN OR BX	1946270000	G.110
BLZ/SL KO BK BX	1545710000	G.110	BLZP 5.00HC/03/270F SN OR BX	1960450000	G.45	BLZP 5.00HC/15/90F SN OR BX	1959340000	G.43	BLZP 5.08HC/04/225F SN OR BX	1945770000	G.111
BLZ/SL KO BK BX	1545710000	G.112	BLZP 5.00HC/03/270L SN OR BX	1960950000	G.45	BLZP 5.00HC/16/180 SN OR BX	1954350000	G.40	BLZP 5.08HC/04/270 SN OR BX	1948810000	G.108
BLZ/SL KO BK BX	1545710000	G.114	BLZP 5.00HC/03/90 SN OR BX	1958290000	G.42	BLZP 5.00HC/16/180F SN OR BX	1955660000	G.41	BLZP 5.08HC/04/270F SN OR BX	1950330000	G.109
BLZ/SL KO BK BX	1545710000	G.116	BLZP 5.00HC/03/90F SN OR BX	1959510000	G.43	BLZP 5.00HC/16/180L SN OR BX	1956230000	G.41	BLZP 5.08HC/04/270L SN OR BX	1947550000	G.109
BLZ/SL KO BK BX	1545710000	G.118	BLZP 5.00HC/04/180 SN OR BX	1954470000	G.40	BLZP 5.00HC/16/270 SN OR BX	1958740000	G.44	BLZP 5.08HC/04/90 SN OR BX	1948020000	G.106
BLZ/SL KO BK BX	1545710000	G.120	BLZP 5.00HC/04/180F SN OR BX	1955780000	G.41	BLZP 5.00HC/16/270F SN OR BX	1959380000	G.45	BLZP 5.08HC/04/90F SN OR BX	1949820000	G.107
BLZ/SL KO BK BX	1545710000	G.122	BLZP 5.00HC/04/180L SN OR BX	1956350000	G.41	BLZP 5.00HC/16/270L SN OR BX	1960820000	G.45	BLZP 5.08HC/04/90L SN OR BX	1948720000	G.107
BLZ/SL KO BK BX	1545710000	G.124	BLZP 5.00HC/04/270 SN OR BX	1959850000	G.44	BLZP 5.00HC/16/90 SN OR BX	1957960000	G.42	BLZP 5.08HC/05/180 SN OR BX	1943610000	G.104
BLZ/SL KO BK BX	1545710000	G.126	BLZP 5.00HC/04/270F SN OR BX	1960440000	G.45	BLZP 5.00HC/16/90F SN OR BX	1959330000	G.43	BLZP 5.08HC/05/180F SN OR BX	1944120000	G.105
BLZ/SL KO BK BX	1545710000	G.128	BLZP 5.00HC/04/270L SN OR BX	1960940000	G.45	BLZP 5.00HC/17/180 SN OR BX	1954330000	G.40	BLZP 5.08HC/05/180L SN OR BX	1944860000	G.105
BLZ/SL KO BK BX	1545710000	G.130	BLZP 5.00HC/04/90 SN OR BX	1958280000	G.42	BLZP 5.00HC/17/180F SN OR BX	1955650000	G.41	BLZP 5.08HC/05/225 SN OR BX	1946800000	G.110
BLZ/SL KO BK BX	1545710000	G.132	BLZP 5.00HC/04/90F SN OR BX	1959500000	G.43	BLZP 5.00HC/17/180L SN OR BX	1956220000	G.41	BLZP 5.08HC/05/225F SN OR BX	1945780000	G.111
BLZ/SL KO BK BX	1545710000	G.134	BLZP 5.00HC/05/180 SN OR BX	1954460000	G.40	BLZP 5.00HC/17/270 SN OR BX	1958730000	G.44	BLZP 5.08HC/05/270 SN OR BX	1948820000	G.108
BLZ/SL KO BK BX	1545710000	G.136	BLZP 5.00HC/05/180F SN OR BX	1955770000	G.41	BLZP 5.00HC/17/270F SN OR BX	1959310000	G.45	BLZP 5.08HC/05/270F SN OR BX	1950340000	G.109
BLZ/SL KO BK BX	1545710000	G.138	BLZP 5.00HC/05/180L SN OR BX	1956340000	G.41	BLZP 5.00HC/17/270L SN OR BX	1960810000	G.45	BLZP 5.08HC/05/270L SN OR BX	1947560000	G.109
BLZ/SL KO BK BX	1545710000	K.52	BLZP 5.00HC/05/270 SN OR BX	1958840000	G.44	BLZP 5.00HC/17/90 SN OR BX	1957910000	G.42	BLZP 5.08HC/05/90 SN OR BX	1948030000	G.106
BLZ/SL KO BK BX	1545710000	K.54	BLZP 5.00HC/05/270F SN OR BX	1960430000	G.45	BLZP 5.00HC/17/90F SN OR BX	1959320000	G.43	BLZP 5.08HC/05/90F SN OR BX	1949830000	G.107
BLZ/SL KO BK BX	1545710000	K.82	BLZP 5.00HC/05/270L SN OR BX	1960930000	G.45	BLZP 5.00HC/18/180 SN OR BX	1954320000	G.40	BLZP 5.08HC/05/90L SN OR BX	1907280000	G.107
BLZ/SL KO BK BX	1545710000	K.84	BLZP 5.00HC/05/90 SN OR BX	1958270000	G.42	BLZP 5.00HC/18/180F SN OR BX	1955640000	G.41	BLZP 5.08HC/06/180 SN OR BX	1943620000	G.104
BLZ/SL KO BK BX	1545710000	K.86	BLZP 5.00HC/05/90F SN OR BX	1959490000	G.43	BLZP 5.00HC/18/180L SN OR BX	1956210000	G.41	BLZP 5.08HC/06/180F SN OR BX	1944130000	G.105
BLZ/SL KO BK BX	1545710000	K.92	BLZP 5.00HC/06/180 SN OR BX	1954450000	G.40	BLZP 5.00HC/18/270 SN OR BX	1958720000	G.44	BLZP 5.08HC/06/180L SN OR BX	1944870000	G.105
BLZ/SL KO OR BX	1573010000	G.22	BLZP 5.00HC/06/180F SN OR BX	1955760000	G.41	BLZP 5.00HC/18/270F SN OR BX	1959280000	G.45	BLZP 5.08HC/06/225 SN OR BX	1946290000	G.110
BLZ/SL KO OR BX	1573010000	G.24	BLZP 5.00HC/06/180L SN OR BX	1956330000	G.41	BLZP 5.00HC/18/270L SN OR BX	1960800000	G.45	BLZP 5.08HC/06/225F SN OR BX	1947590000	G.111
BLZ/SL KO OR BX	1573010000	G.26	BLZP 5.00HC/06/270 SN OR BX	1958830000	G.44	BLZP 5.00HC/18/90 SN OR BX	1957900000	G.42	BLZP 5.08HC/06/270 SN OR BX	1948830000	G.108
BLZ/SL KO OR BX	1573010000	G.28	BLZP 5.00HC/06/270F SN OR BX	1960420000	G.45	BLZP 5.00HC/18/90F SN OR BX	1959300000	G.43	BLZP 5.08HC/06/270F SN OR BX	1950350000	G.109
BLZ/SL KO OR BX	1573010000	G.30	BLZP 5.00HC/06/270L SN OR BX	1960920000	G.45	BLZP 5.00HC/19/180 SN OR BX	1954310000	G.40	BLZP 5.08HC/06/270L SN OR BX	1947570000	G.109
BLZ/SL KO OR BX	1573010000	G.32	BLZP 5.00HC/06/90 SN OR BX	1958260000	G.42	BLZP 5.00HC/19/180F SN OR BX	1955630000	G.41	BLZP 5.08HC/06/90 SN OR BX	1948040000	G.106
BLZ/SL KO OR BX	1573010000	G.34	BLZP 5.00HC/06/90F SN OR BX	1959480000	G.43	BLZP 5.00HC/19/180L SN OR BX	1956200000	G.41	BLZP 5.08HC/06/90F SN OR BX	1949840000	G.107
BLZ/SL KO OR BX	1573010000	G.36	BLZP 5.00HC/07/180 SN OR BX	1954440000	G.40	BLZP 5.00HC/19/270 SN OR BX	1958710000	G.44	BLZP 5.08HC/06/90L SN OR BX	1907290000	G.107
BLZ/SL KO OR BX	1573010000	G.38	BLZP 5.00HC/07/180F SN OR BX	1955750000	G.41	BLZP 5.00HC/19/270F SN OR BX	1959260000	G.45	BLZP 5.08HC/07/180 SN OR BX	1943630000	G.104
BLZ/SL KO OR BX	1573010000	G.40	BLZP 5.00HC/07/180L SN OR BX	1956320000	G.41	BLZP 5.00HC/19/270L SN OR BX	1960790000	G.45	BLZP 5.08HC/07/180F SN OR BX	1944140000	G.105
BLZ/SL KO OR BX	1573010000	G.42	BLZP 5.00HC/07/270 SN OR BX	1958820000	G.44	BLZP 5.00HC/19/90 SN OR BX	1957880000	G.42	BLZP 5.08HC/07/180L SN OR BX	1944880000	G.105
BLZ/SL KO OR BX	1573010000	G.44	BLZP 5.00HC/07/270F SN OR BX	1960410000	G.45	BLZP 5.00HC/19/90F SN OR BX	1959290000	G.43	BLZP 5.08HC/07/225 SN OR BX	1946300000	G.110
BLZ/SL KO OR BX	1573010000	G.46	BLZP 5.00HC/07/270L SN OR BX	1960910000	G.45	BLZP 5.00HC/20/180 SN OR BX	1954300000	G.40	BLZP 5.08HC/07/225F SN OR BX	1947580000	G.111
BLZ/SL KO OR BX	1573010000	G.48	BLZP 5.00HC/07/90 SN OR BX	1958250000	G.42	BLZP 5.00HC/20/180F SN OR BX	1955620000	G.41	BLZP 5.08HC/07/270 SN OR BX	1948840000	G.108
BLZ/SL KO OR BX	1573010000	G.50	BLZP 5.00HC/07/90F SN OR BX	1959470000	G.43	BLZP 5.00HC/20/180L SN OR BX	1956190000	G.41	BLZP 5.08HC/07/270F SN OR BX	1950360000	G.109
BLZ/SL KO OR BX	1573010000	G.52	BLZP 5.00HC/08/180 SN OR BX	1954430000	G.40	BLZP 5.00HC/20/270 SN OR BX	1958700000	G.44	BLZP 5.08HC/07/270L SN OR BX	1947580000	G.109
BLZ/SL KO OR BX	1573010000	G.54	BLZP 5.00HC/08/180F SN OR BX	1955740000	G.41	BLZP 5.00HC/20/270F SN OR BX	1959230000	G.45	BLZP 5.08HC/07/90 SN OR BX	1948050000	G.106
BLZ/SL KO OR BX	1573010000	G.56	BLZP 5.00HC/08/180L SN OR BX	1956310000	G.41	BLZP 5.00HC/20/270L SN OR BX	1960780000	G.45	BLZP 5.08HC/07/90F SN OR BX	1949850000	G.107
BLZ/SL KO OR BX	1573010000	G.58	BLZP 5.00HC/08/270 SN OR BX	1958810000	G.44	BLZP 5.00HC/20/90 SN OR BX	1957850000	G.42	BLZP 5.08HC/07/90L SN OR BX	1907300000	G.107
BLZ/SL KO OR BX	1573010000	G.60	BLZP 5.00HC/08/270F SN OR BX	1960400000	G.45	BLZP 5.00HC/20/90F SN OR BX	1959270000	G.43	BLZP 5.08HC/08/180 SN OR BX	1943640000	G.104
BLZ/SL KO OR BX	1573010000	G.62	BLZP 5.00HC/08/270L SN OR BX	1960900000	G.45	BLZP 5.00HC/21/180 SN OR BX	1954290000	G.40	BLZP 5.08HC/08/180F SN OR BX	1944150000	G.105
BLZ/SL KO OR BX	1573010000	G.64	BLZP 5.00HC/08/90 SN OR BX	1958230000	G.42	BLZP 5.00HC/21/180F SN OR BX	1955610000	G.41	BLZP 5.08HC/08/180L SN OR BX	1944890000	G.105
BLZ/SL KO OR BX	1573010000	G.66	BLZP 5.00HC/08/90F SN OR BX	1959460000	G.43	BLZP 5.00HC/21/180L SN OR BX	1956210000	G.41	BLZP 5.08HC/08/225 SN OR BX	1946310000	G.110
BLZ/SL KO OR BX	1573010000	G.68	BLZP 5.00HC/09/180 SN OR BX	1954420000	G.40	BLZP 5.00HC/21/270 SN OR BX	1958690000	G.44	BLZP 5.08HC/08/225F SN OR BX	1945810000	G.111
BLZ/SL KO OR BX	1573010000	G.70	BLZP 5.00HC/09/180F SN OR BX	1955730000	G.41	BLZP 5.00HC/21/270F SN OR BX	1959210000	G.45	BLZP 5.08HC/08/270 SN OR BX	1948850000	G.108
BLZ/SL KO OR BX	1573010000	G.72	BLZP 5.00HC/09/180L SN OR BX	1956300000	G.41	BLZP 5.00HC/21/270L SN OR BX	1960770000	G.45	BLZP 5.08HC/08/270F SN OR BX	1950370000	G.109
BLZ/SL KO OR BX	1573010000	G.74	BLZP 5.00HC/09/270 SN OR BX	1958800000	G.44	BLZP 5.00HC/21/90 SN OR BX	1957830000	G.42	BLZP 5.08HC/08/270L SN OR BX	1947590000	G.109
BLZ/SL KO OR BX	1573010000	G.76	BLZP 5.00HC/09/270F SN OR BX	1960390000	G.45	BLZP 5.00HC/21/90F SN OR BX	1959250000	G.43	BLZP 5.08HC/09/180 SN OR BX	1948700000	G.106
BLZ/SL KO OR BX	1573010000	G.78	BLZP 5.00HC/09/270L SN OR BX	1960890000	G.45	BLZP 5.00HC/22/180 SN OR BX	1954280000	G.40	BLZP 5.08HC/09/90F SN OR BX	1949860000	G.107
BLZ/SL KO OR BX	1573010000	G.80	BLZP 5.00HC/09/90 SN OR BX	1958190000	G.42	BLZP 5.00HC/22/180F SN OR BX	1955600000	G.41	BLZP 5.08HC/09/90L SN OR BX	1907310000	G.107
BLZ/SL KO OR BX	1573010000	G.82	BLZP 5.00HC/09/90F SN OR BX	1959440000	G.43	BLZP 5.00HC/22/180L SN OR BX	1956170000	G.41	BLZP 5.0		











Type	Order No.	Page	Type	Order No.	Page	Type	Order No.	Page	Type	Order No.	Page
LM2N 5.08/26/90 3.5SN DR BX	1768960000	C.26	LMF 5.00/19/90 3.5SN DR BX	1331890000	C.90	LMFS 5.00/23/180 3.5SN DR BX	1330690000	C.91	LMZF 10/3/135 3.5OR	1953940000	C.101
LM2N 5.08/28/90 3.5SN DR BX	1768970000	C.26	LMF 5.00/20/180 3.5SN DR BX	1330380000	C.91	LMFS 5.00/23/90 3.5SN DR BX	1332190000	C.91	LMZF 10/4/135 3.5OR	1953950000	C.101
LM2N 5.08/30/90 3.5SN DR BX	1768980000	C.26	LMF 5.00/20/90 3.5SN DR BX	1331910000	C.90	LMFS 5.00/24/90 3.5SN DR BX	1332200000	C.91	LMZF 10/5/135 3.5OR	1953960000	C.101
LM2N 5.08/32/90 3.5SN DR BX	1768990000	C.26	LMF 5.00/21/180 3.5SN DR BX	1330390000	C.91	LMFS 5.00/24/90 3.5SN DR BX	1332200000	C.91	LMZF 10/6/135 3.5OR	1953970000	C.101
LM2N 5.08/34/90 3.5SN DR BX	1769000000	C.26	LMF 5.00/21/90 3.5SN DR BX	1331920000	C.90	LMFS 5.08/02/180 3.5SN DR BX	1331430000	C.93	LMZF 10/7/135 3.5OR	1953980000	C.101
LM2N 5.08/36/90 3.5SN DR BX	1769010000	C.26	LMF 5.00/22/180 3.5SN DR BX	1330400000	C.91	LMFS 5.08/02/90 3.5SN DR BX	1330960000	C.93	LMZF 10/8/135 3.5OR	1953990000	C.101
LM2N 5.08/38/90 3.5SN DR BX	1769020000	C.26	LMF 5.00/22/90 3.5SN DR BX	1331930000	C.90	LMFS 5.08/03/180 3.5SN DR BX	1331440000	C.93	LMZF 10/9/135 3.5OR	1954000000	C.101
LM2N 5.08/40/90 3.5SN DR BX	1769030000	C.26	LMF 5.00/23/180 3.5SN DR BX	1330410000	C.91	LMFS 5.08/03/90 3.5SN DR BX	1330970000	C.93	LMZF 5/10/135 3.5OR	1914860000	C.97
LM2N 5.08/42/90 3.5SN DR BX	1769040000	C.26	LMF 5.00/23/90 3.5SN DR BX	1331940000	C.90	LMFS 5.08/04/180 3.5SN DR BX	1331450000	C.93	LMZF 5/11/135 3.5OR	1914990000	C.97
LM2N 5.08/44/90 3.5SN DR BX	1769050000	C.26	LMF 5.00/24/180 3.5SN DR BX	1330420000	C.91	LMFS 5.08/04/90 3.5SN DR BX	1330980000	C.93	LMZF 5/12/135 3.5OR	1915030000	C.97
LM2N 5.08/46/90 3.5SN DR BX	1769060000	C.26	LMF 5.00/24/90 3.5SN DR BX	1331950000	C.90	LMFS 5.08/05/180 3.5SN DR BX	1331470000	C.93	LMZF 5/13/135 3.5OR	1958320000	C.97
LM2N 5.08/48/90 3.5SN DR BX	1769070000	C.26	LMF 5.08/02/180 3.5SN DR BX	1331080000	C.93	LMFS 5.08/05/90 3.5SN DR BX	1330990000	C.93	LMZF 5/14/135 3.5OR	1958330000	C.97
LM2NZF 5.08/04/135 3.5SN DR BX	1764810000	C.102	LMF 5.08/02/90 3.5SN DR BX	1330710000	C.92	LMFS 5.08/06/180 3.5SN DR BX	1331480000	C.93	LMZF 5/15/135 3.5OR	1958350000	C.97
LM2NZF 5.08/06/135 3.5SN DR BX	1764820000	C.102	LMF 5.08/03/180 3.5SN DR BX	1331100000	C.93	LMFS 5.08/06/90 3.5SN DR BX	1331000000	C.93	LMZF 5/16/135 3.5OR	1958370000	C.97
LM2NZF 5.08/08/135 3.5SN DR BX	1764830000	C.102	LMF 5.08/03/90 3.5SN DR BX	1330720000	C.92	LMFS 5.08/07/180 3.5SN DR BX	1331490000	C.93	LMZF 5/17/135 3.5OR	1958390000	C.97
LM2NZF 5.08/10/135 3.5SN DR BX	1764840000	C.102	LMF 5.08/04/180 3.5SN DR BX	1331120000	C.93	LMFS 5.08/07/90 3.5SN DR BX	1331010000	C.93	LMZF 5/18/135 3.5OR	1958410000	C.97
LM2NZF 5.08/12/135 3.5SN DR BX	1764850000	C.102	LMF 5.08/04/90 3.5SN DR BX	1330730000	C.92	LMFS 5.08/08/180 3.5SN DR BX	1331500000	C.93	LMZF 5/19/135 3.5OR	1958440000	C.97
LM2NZF 5.08/14/135 3.5SN DR BX	1764860000	C.102	LMF 5.08/05/180 3.5SN DR BX	1331140000	C.93	LMFS 5.08/08/90 3.5SN DR BX	1331020000	C.93	LMZF 5/2/135 3.5OR	1914560000	C.97
LM2NZF 5.08/16/135 3.5SN DR BX	1764870000	C.102	LMF 5.08/05/90 3.5SN DR BX	1330740000	C.92	LMFS 5.08/09/180 3.5SN DR BX	1331510000	C.93	LMZF 5/20/135 3.5OR	1958450000	C.97
LM2NZF 5.08/18/135 3.5SN DR BX	1764880000	C.102	LMF 5.08/06/180 3.5SN DR BX	1331160000	C.93	LMFS 5.08/09/90 3.5SN DR BX	1331030000	C.93	LMZF 5/21/135 3.5OR	1958470000	C.97
LM2NZF 5.08/20/135 3.5SN DR BX	1768200000	C.102	LMF 5.08/06/90 3.5SN DR BX	1330750000	C.92	LMFS 5.08/10/180 3.5SN DR BX	1331520000	C.93	LMZF 5/22/135 3.5OR	1958490000	C.97
LM2NZF 5.08/22/135 3.5SN DR BX	1764890000	C.102	LMF 5.08/07/180 3.5SN DR BX	1331180000	C.93	LMFS 5.08/10/90 3.5SN DR BX	1331040000	C.93	LMZF 5/23/135 3.5OR	1958500000	C.97
LM2NZF 5.08/24/135 3.5SN DR BX	1764900000	C.102	LMF 5.08/07/90 3.5SN DR BX	1330770000	C.92	LMFS 5.08/11/180 3.5SN DR BX	1331530000	C.93	LMZF 5/24/135 3.5OR	1958510000	C.97
LM2NZF 5.08/26/135 3.5SN DR BX	1768250000	C.102	LMF 5.08/08/180 3.5SN DR BX	1331200000	C.93	LMFS 5.08/11/90 3.5SN DR BX	1331050000	C.93	LMZF 5/3/135 3.5OR	1914580000	C.97
LM2NZF 5.08/28/135 3.5SN DR BX	1768250000	C.102	LMF 5.08/08/90 3.5SN DR BX	1330780000	C.92	LMFS 5.08/12/180 3.5SN DR BX	1331540000	C.93	LMZF 5/4/135 3.5OR	1914590000	C.97
LM2NZF 5.08/30/135 3.5SN DR BX	1768250000	C.102	LMF 5.08/09/180 3.5SN DR BX	1331220000	C.93	LMFS 5.08/12/90 3.5SN DR BX	1331060000	C.93	LMZF 5/5/135 3.5OR	1914600000	C.97
LM2NZF 5.08/32/135 3.5SN DR BX	1768250000	C.102	LMF 5.08/09/90 3.5SN DR BX	1330790000	C.92	LMFS 5.08/13/180 3.5SN DR BX	1331550000	C.93	LMZF 5/6/135 3.5OR	1914640000	C.97
LM2NZF 5.08/34/135 3.5SN DR BX	1768250000	C.102	LMF 5.08/10/180 3.5SN DR BX	1331240000	C.93	LMFS 5.08/13/90 3.5SN DR BX	1331070000	C.93	LMZF 5/7/135 3.5OR	1914720000	C.97
LM2NZF 5.08/36/135 3.5SN DR BX	1768250000	C.102	LMF 5.08/10/90 3.5SN DR BX	1330800000	C.92	LMFS 5.08/14/180 3.5SN DR BX	1331570000	C.93	LMZF 5/8/135 3.5OR	1914790000	C.97
LM3R 5.08/06/90 3.5SN DR BX	1769200000	C.27	LMF 5.08/11/180 3.5SN DR BX	1331260000	C.93	LMFS 5.08/14/90 3.5SN DR BX	1331090000	C.93	LMZF 5/9/135 3.5OR	1914830000	C.97
LM3R 5.08/09/90 3.5SN DR BX	1769630000	C.27	LMF 5.08/11/90 3.5SN DR BX	1330810000	C.92	LMFS 5.08/15/180 3.5SN DR BX	1331580000	C.93	LMZF 7/10/135 3.5OR	1953090000	C.99
LM3R 5.08/12/90 3.5SN DR BX	1769640000	C.27	LMF 5.08/12/180 3.5SN DR BX	1331280000	C.93	LMFS 5.08/15/90 3.5SN DR BX	1331110000	C.93	LMZF 7/11/135 3.5OR	1953100000	C.99
LM3R 5.08/15/90 3.5SN DR BX	1769650000	C.27	LMF 5.08/12/90 3.5SN DR BX	1330820000	C.92	LMFS 5.08/16/180 3.5SN DR BX	1331590000	C.93	LMZF 7/12/135 3.5OR	1953110000	C.99
LM3R 5.08/18/90 3.5SN DR BX	1769660000	C.27	LMF 5.08/13/180 3.5SN DR BX	1331300000	C.93	LMFS 5.08/16/90 3.5SN DR BX	1331130000	C.93	LMZF 7/2/135 3.5OR	1953010000	C.99
LM3R 5.08/21/90 3.5SN DR BX	1769670000	C.27	LMF 5.08/13/90 3.5SN DR BX	1330830000	C.92	LMFS 5.08/17/180 3.5SN DR BX	1331610000	C.93	LMZF 7/3/135 3.5OR	1953020000	C.99
LM3R 5.08/24/90 3.5SN DR BX	1769680000	C.27	LMF 5.08/14/180 3.5SN DR BX	1331310000	C.93	LMFS 5.08/17/90 3.5SN DR BX	1331150000	C.93	LMZF 7/4/135 3.5OR	1953030000	C.99
LM3R 5.08/27/90 3.5SN DR BX	1769690000	C.27	LMF 5.08/14/90 3.5SN DR BX	1330840000	C.92	LMFS 5.08/18/180 3.5SN DR BX	1331620000	C.93	LMZF 7/5/135 3.5OR	1953040000	C.99
LM3R 5.08/30/90 3.5SN DR BX	1769700000	C.27	LMF 5.08/15/180 3.5SN DR BX	1331320000	C.93	LMFS 5.08/18/90 3.5SN DR BX	1331170000	C.93	LMZF 7/6/135 3.5OR	1953050000	C.99
LM3R 5.08/33/90 3.5SN DR BX	1769710000	C.27	LMF 5.08/15/90 3.5SN DR BX	1330850000	C.92	LMFS 5.08/19/180 3.5SN DR BX	1331630000	C.93	LMZF 7/7/135 3.5OR	1953060000	C.99
LM3R 5.08/36/90 3.5SN DR BX	1769720000	C.27	LMF 5.08/16/180 3.5SN DR BX	1331330000	C.93	LMFS 5.08/19/90 3.5SN DR BX	1331190000	C.93	LMZF 7/8/135 3.5OR	1953070000	C.99
LM3R 5.08/39/90 3.5SN DR BX	1769730000	C.27	LMF 5.08/16/90 3.5SN DR BX	1330870000	C.92	LMFS 5.08/20/180 3.5SN DR BX	1331640000	C.93	LMZF 7/9/135 3.5OR	1953080000	C.99
LM3R 5.08/42/90 3.5SN DR BX	1769740000	C.27	LMF 5.08/17/180 3.5SN DR BX	1331340000	C.93	LMFS 5.08/20/90 3.5SN DR BX	1331210000	C.93	LPA B2Z	14952760000	1.14
LM3R 5.08/45/90 3.5SN DR BX	1769750000	C.27	LMF 5.08/17/90 3.5SN DR BX	1330880000	C.92	LMFS 5.08/21/180 3.5SN DR BX	1331650000	C.93	LPA B23	14973760000	1.14
LM3R 5.08/48/90 3.5SN DR BX	1769760000	C.27	LMF 5.08/18/180 3.5SN DR BX	1331350000	C.93	LMFS 5.08/21/90 3.5SN DR BX	1331230000	C.93	LPA FAZ	1495960000	1.14
LM3R 5.08/51/90 3.5SN DR BX	1769770000	C.27	LMF 5.08/18/90 3.5SN DR BX	1330890000	C.92	LMFS 5.08/22/180 3.5SN DR BX	1331670000	C.93	LPA FA2 BZ	1496160000	1.14
LM3R 5.08/54/90 3.5SN DR BX	1769780000	C.27	LMF 5.08/19/180 3.5SN DR BX	1331370000	C.93	LMFS 5.08/22/90 3.5SN DR BX	1331250000	C.93	LPA FA3	1496060000	1.14
LM3R 5.08/57/90 3.5SN DR BX	1769790000	C.27	LMF 5.08/19/90 3.5SN DR BX	1330900000	C.92	LMFS 5.08/23/180 3.5SN DR BX	1331680000	C.93	LPA FA3 BZ	1496260000	1.14
LM3R 5.08/60/90 3.5SN DR BX	1769800000	C.27	LMF 5.08/20/180 3.5SN DR BX	1331380000	C.93	LMFS 5.08/23/90 3.5SN DR BX	1331270000	C.93	LPA B0	1472500000	1.15
LM3R 5.08/63/90 3.5SN DR BX	1769810000	C.27	LMF 5.08/20/90 3.5SN DR BX	1330910000	C.92	LMFS 5.08/24/180 3.5SN DR BX	1331690000	C.93	LPA B0 17	1584770000	1.15
LM3R 5.08/66/90 3.5SN DR BX	1769820000	C.27	LMF 5.08/21/180 3.5SN DR BX	1331390000	C.93	LMFS 5.08/24/90 3.5SN DR BX	1331290000	C.93	LPA B0 2	1472200000	1.15
LM3R 5.08/69/90 3.5SN DR BX	1769830000	C.27	LMF 5.08/21/90 3.5SN DR BX	1330920000	C.92	LMZF 10/10/135 3.5OR	1953550000	C.100	LPA B0 24	1472600000	1.15
LM3R 5.08/72/90 3.5SN DR BX	1769840000	C.27	LMF 5.08/22/180 3.5SN DR BX	1331400000	C.93	LMZF 10/11/135 3.5OR	1953560000	C.100	LPA B0 3	1472300000	1.15
LM3RZF 5.08/06/135 3.5SN DR BX	1764910000	C.103	LMF 5.08/22/90 3.5SN DR BX	1330930000	C.92	LMZF 10/12/135 3.5OR	1953570000	C.100	LPA B0 4	1472400000	1.15
LM3RZF 5.08/08/135 3.5SN DR BX	1764920000	C.103	LMF 5.08/23/180 3.5SN DR BX	1331410000	C.93	LMZF 10/2/135 3.5OR	1953470000	C.100	LPA SI STI3 2 OR	1495060000	1.13
LM3RZF 5.08/10/135 3.5SN DR BX	1764930000	C.103	LMF 5.08/23/90 3.5SN DR BX	1330940000	C.92	LMZF 10/3/135 3.5OR	1953480000	C.100	LPA STI3 2 OR	1495480000	1.13
LM3RZF 5.08/15/135 3.5SN DR BX	1764940000	C.103	LMF 5.08/24/180 3.5SN DR BX	1331420000	C.93	LMZF 10/4/135 3.5OR	1953490000	C.100	LPA BU MU OR	1747530000	1.17
LM3RZF 5.08/18/135 3.5SN DR BX	1764950000	C.103	LMF 5.08/24/90 3.5SN DR BX	1330950000	C.92	LMZF 10/5/135 3.5OR	1953500000	C.100	LPBB OR	1747540000	1.17
LM3RZF 5.08/21/135 3.5SN DR BX	1768040000	C.103	LMFS 5.00/02/180 3.5SN DR BX	1330340000	C.91	LMZF 10/6/135 3.5OR	1953510000	C.100	LPZP 1.27/90 OR	1747940000	1.12
LM3RZF 5.08/24/135 3.5SN DR BX	1764960000	C.103	LMFS 5.00/02/90 3.5SN DR BX	1331960000	C.91	LMZF 10/7/135 3.5OR	1953520000	C.100	LPZP 2.54/135 OR	1753740000	1.12
LM3RZF 5.08/27/135 3.5SN DR BX	1764970000	C.103	LMFS 5.00/03/180 3.5SN DR BX	1330440000	C.91	LMZF 10/8/135 3.5OR	1953530000	C.100	LPZP 2.54/135 SW	1753750000	1.12
LM3RZF 5.08/30/135 3.5SN DR BX	1764980000	C.103	LMFS 5.00/03/90 3.5SN DR BX	1331970000	C.91	LMZF 10/9/135 3.5OR	1953540000	C.100	LPZP 2.54/90 OR	1747870000	1.12
LM3RZF 5.08/33/135 3.5SN DR BX	1764980000	C.103	LMFS 5.00/04/180 3.5SN DR BX	1330450000	C.91	LMZF 5/10/135 3.5OR	1914070000	C.96	LPZP 2.54/90 SW	1747500000	1.12
LM3RZF 5.08/36/135 3.5SN DR BX	1764990000	C.103	LMFS 5.00/04/90 3.5SN DR BX	1331980000	C.91	LMZF 5/11/135 3.5OR	1914080000	C.96	LPZP 1.25 2.54 OR	1747470000	1.13
LM3RZF 5.08/48/135 3.5SN DR BX	1768050000	C.103	LMFS 5.00/05/180 3.5SN								





Type	Order No.	Page
LSF-SMT 7.62/07/180 1.5SN BK TU	1869870000	C.82
LSF-SMT 7.62/07/180 3.5SN BK TU	1826260000	C.82
LSF-SMT 7.62/07/90 1.5SN BK TU	1869310000	C.78
LSF-SMT 7.62/07/90 3.5SN BK TU	1825000000	C.78
LSF-SMT 7.62/08/135 1.5SN BK TU	1885010000	C.80
LSF-SMT 7.62/08/135 3.5SN BK TU	1886240000	C.80
LSF-SMT 7.62/08/180 1.5SN BK TU	1869880000	C.82
LSF-SMT 7.62/08/180 3.5SN BK TU	1826270000	C.82
LSF-SMT 7.62/08/90 1.5SN BK TU	1869320000	C.78
LSF-SMT 7.62/08/90 3.5SN BK TU	1825010000	C.78
LU 10.16/02/90 4.5SN BK BX	1934140000	J.18
LU 10.16/03/90 4.5SN BK BX	1921450000	J.18
LU 10.16/04/90 4.5SN BK BX	1226220000	J.18
LU 10.16/05/90 4.5SN BK BX	1226230000	J.18
LU 10.16/06/90 4.5SN BK BX	1226240000	J.18
LU 10.16/07/90 4.5SN BK BX	1226250000	J.18
LU 10.16/08/90 4.5SN BK BX	1226260000	J.18
LU 10.16/09/90 4.5SN BK BX	1226270000	J.18
LU 10.16/10/90 4.5SN BK BX	1226280000	J.18
LUF 10.00/01/90 5.0SN BK BX	1989859000	J.32
LUF 10.00/02/90 5.0SN BK BX	1988600000	J.32
LUF 10.00/02/90V 5.0SN BK BX	2453690000	J.33
LUF 10.00/03/90 5.0SN BK BX	1988610000	J.32
LUF 10.00/03/90V 5.0SN BK BX	2453700000	J.33
LUF 10.00/04/90 5.0SN BK BX	1988620000	J.32
LUF 10.00/04/90V 5.0SN BK BX	2453710000	J.33
LUF 10.00/05/90 5.0SN BK BX	1988630000	J.32
LUF 10.00/05/90V 5.0SN BK BX	2453720000	J.33
LUF 10.00/06/90 5.0SN BK BX	1988640000	J.32
LUF 10.00/06/90V 5.0SN BK BX	2453730000	J.33
LUF 10.00/07/90 5.0SN BK BX	1988650000	J.32
LUF 10.00/07/90V 5.0SN BK BX	2453740000	J.33
LUF 10.00/08/90 5.0SN BK BX	1988660000	J.32
LUF 10.00/08/90V 5.0SN BK BX	2453750000	J.33
LUF 10.00/09/90 5.0SN BK BX	1988670000	J.32
LUF 10.00/09/90V 5.0SN BK BX	2453760000	J.33
LUF 10.00/10/90 5.0SN BK BX	1988680000	J.32
LUF 10.00/10/90V 5.0SN BK BX	2453770000	J.33
LUF 10.00/11/90 5.0SN BK BX	1988690000	J.32
LUF 10.00/11/90V 5.0SN BK BX	2453780000	J.33
LUF 10.00/12/90 5.0SN BK BX	1988700000	J.32
LUF 10.00/12/90V 5.0SN BK BX	2453790000	J.33
LUF 15.00/02/90 5.0SN BK BX	2491800000	J.38
LUF 15.00/02/90V 5.0SN BK BX	2492000000	J.39
LUF 15.00/03/90 5.0SN BK BX	2491900000	J.38
LUF 15.00/03/90V 5.0SN BK BX	2492010000	J.39
LUF 15.00/04/90 5.0SN BK BX	2491910000	J.38
LUF 15.00/04/90V 5.0SN BK BX	2492020000	J.39
LUF 15.00/05/90 5.0SN BK BX	2491920000	J.38
LUF 15.00/05/90V 5.0SN BK BX	2492030000	J.39
LUF 15.00/06/90 5.0SN BK BX	2491930000	J.38
LUF 15.00/06/90V 5.0SN BK BX	2492040000	J.39
LUF 15.00/07/90 5.0SN BK BX	2491940000	J.38
LUF 15.00/07/90V 5.0SN BK BX	2492050000	J.39
LUF 15.00/08/90 5.0SN BK BX	2491950000	J.38
LUF 15.00/08/90V 5.0SN BK BX	2492060000	J.39
LUF 15.00/09/90 5.0SN BK BX	2491960000	J.38
LUF 15.00/09/90V 5.0SN BK BX	2492070000	J.39
LUF 15.00/10/90 5.0SN BK BX	2491970000	J.38
LUF 15.00/10/90V 5.0SN BK BX	2492080000	J.39
LUF 15.00/11/90 5.0SN BK BX	2491980000	J.38
LUF 15.00/11/90V 5.0SN BK BX	2492090000	J.39
LUF 15.00/12/90 5.0SN BK BX	2491990000	J.38
LUF 15.00/12/90V 5.0SN BK BX	2492100000	J.39
LUF 15.00/02/90V 5.0SN BK BX	2493430000	J.35
LUF 15.00/03/180V 5.0SN BK BX	2492120000	J.37
LUF 15.00/03/90V 5.0SN BK BX	2500460000	J.35
LUF 15.00/04/180V 5.0SN BK BX	2492130000	J.37
LUF 15.00/04/90V 5.0SN BK BX	2500470000	J.35
LUF 15.00/05/180V 5.0SN BK BX	2492140000	J.37
LUF 15.00/05/90V 5.0SN BK BX	2500480000	J.35
LUF 15.00/06/180V 5.0SN BK BX	2492150000	J.37
LUF 15.00/06/90V 5.0SN BK BX	2500490000	J.35
LUF 15.00/07/180V 5.0SN BK BX	2492160000	J.37
LUF 15.00/07/90V 5.0SN BK BX	2500500000	J.35
LUF 15.00/08/180V 5.0SN BK BX	2492170000	J.37
LUF 15.00/08/90V 5.0SN BK BX	2500510000	J.35
LUF 15.00/09/180V 5.0SN BK BX	2492180000	J.37
LUF 15.00/09/90V 5.0SN BK BX	2500520000	J.35
LUF 15.00/10/180V 5.0SN BK BX	2492190000	J.37
LUF 15.00/10/90V 5.0SN BK BX	2500530000	J.35
LUF 15.00/11/180V 5.0SN BK BX	2492200000	J.37
LUF 15.00/11/90V 5.0SN BK BX	2500540000	J.35
LUF 15.00/12/180V 5.0SN BK BX	2492210000	J.37
LUF 15.00/12/90V 5.0SN BK BX	2500550000	J.35
LUF 15.00/02/180V 5.0SN BK BX	2491820000	J.41
LUF 15.00/02/90V 5.0SN BK BX	2499440000	J.40
LUF 15.00/03/180V 5.0SN BK BX	2492220000	J.41
LUF 15.00/03/90V 5.0SN BK BX	2500570000	J.40
LUF 15.00/04/180V 5.0SN BK BX	2492230000	J.41
LUF 15.00/04/90V 5.0SN BK BX	2500580000	J.40
LUF 15.00/05/180V 5.0SN BK BX	2492240000	J.41
LUF 15.00/05/90V 5.0SN BK BX	2500590000	J.40
LUF 15.00/06/180V 5.0SN BK BX	2492250000	J.41
LUF 15.00/06/90V 5.0SN BK BX	2500600000	J.40
LUF 15.00/07/180V 5.0SN BK BX	2492260000	J.41
LUF 15.00/07/90V 5.0SN BK BX	2500600000	J.40
LUF 15.00/08/180V 5.0SN BK BX	2492270000	J.41
LUF 15.00/08/90V 5.0SN BK BX	2500610000	J.40
LUP 10.16/02/90 5.0SN BK BX	2014050000	J.19
LUP 10.16/02/90V 5.0SN BK BX	2012810000	J.20
LUP 10.16/03/90 5.0SN BK BX	2014060000	J.19
LUP 10.16/03/90V 5.0SN BK BX	2012890000	J.20
LUP 10.16/04/90 5.0SN BK BX	2014090000	J.19

Type	Order No.	Page
LUP 10.16/04/90V 5.0SN BK BX	2013870000	J.20
LUP 10.16/05/90 5.0SN BK BX	2014140000	J.19
LUP 10.16/05/90V 5.0SN BK BX	2013880000	J.20
LUP 10.16/06/90 5.0SN BK BX	2014150000	J.19
LUP 10.16/06/90V 5.0SN BK BX	2013890000	J.20
LUP 10.16/07/90 5.0SN BK BX	2014160000	J.19
LUP 10.16/07/90V 5.0SN BK BX	2013900000	J.20
LUP 10.16/08/90 5.0SN BK BX	2014170000	J.19
LUP 10.16/08/90V 5.0SN BK BX	2013910000	J.20
LUP 10.16/09/90 5.0SN BK BX	2014180000	J.19
LUP 10.16/09/90V 5.0SN BK BX	2013920000	J.20
LUP 12.70/02/90 5.0SN BK BX	2014360000	J.21
LUP 12.70/03/90 5.0SN BK BX	2014380000	J.21
LUP 12.70/04/90 5.0SN BK BX	2014400000	J.21
LUP 12.70/05/90 5.0SN BK BX	2014420000	J.21
LUP 12.70/06/90 5.0SN BK BX	2014590000	J.21
LUP 12.70/07/90 5.0SN BK BX	2014610000	J.21
LUP 12.70/08/90 5.0SN BK BX	2014760000	J.21
LUP 12.70/09/90 5.0SN BK BX	2014900000	J.21
LX 15.00/01/90 4.5SN BK BX	1226460000	J.22
LX 15.00/02/90 4.5SN BK BX	1226470000	J.22
LX 15.00/03/90 4.5SN BK BX	1174720000	J.22
LX 15.00/04/90 4.5SN BK BX	1226480000	J.22
LX 15.00/05/90 4.5SN BK BX	1226490000	J.22
LX 15.00/06/90 4.5SN BK BX	1226500000	J.22
LX 15.00/07/90 4.5SN BK BX	1226510000	J.22
LX 15.00/08/90 4.5SN BK BX	1921480000	J.23
LXB 15.00/02/90 4.5SN BK BX	1226520000	J.23
LXB 15.00/03/90 4.5SN BK BX	1226530000	J.23
LXB 15.00/04/90 4.5SN BK BX	1226540000	J.23
LXB 15.00/05/90 4.5SN BK BX	1226550000	J.23
LXB 15.00/06/90 4.5SN BK BX	1226560000	J.23
LXB 15.00/07/90 4.5SN BK BX	1226570000	J.23
LXB 15.00/08/90 4.5SN BK BX	1226580000	J.23
LXBL 15.00/01/90 4.5SN BK BX	1226590000	J.23
LXXX 15.00/01/90 4.5SN BK BX	1047120000	J.24
LXXX 15.00/01/90F 4.5SN BK BX	1047280000	J.25
LXXX 15.00/01/90FL 4.5SN BK BX	1047440000	J.25
LXXX 15.00/01/90FR 4.5SN BK BX	1047600000	J.25
LXXX 15.00/02/90 4.5SN BK BX	1047130000	J.24
LXXX 15.00/02/90F 4.5SN BK BX	1047290000	J.25
LXXX 15.00/02/90FL 4.5SN BK BX	1047450000	J.25
LXXX 15.00/02/90FR 4.5SN BK BX	1047610000	J.25
LXXX 15.00/03/90 4.5SN BK BX	1047140000	J.24
LXXX 15.00/03/90F 4.5SN BK BX	1047300000	J.25
LXXX 15.00/03/90FL 4.5SN BK BX	1047460000	J.25
LXXX 15.00/03/90FR 4.5SN BK BX	1047620000	J.25
LXXX 15.00/04/90 4.5SN BK BX	1047150000	J.24
LXXX 15.00/04/90F 4.5SN BK BX	1047310000	J.25
LXXX 15.00/04/90FL 4.5SN BK BX	1047470000	J.25
LXXX 15.00/04/90FR 4.5SN BK BX	1047630000	J.25
LXXX 15.00/05/90 4.5SN BK BX	1386250000	J.24
LXXX 15.00/05/90F 4.5SN BK BX	1386290000	J.25
LXXX 15.00/05/90FL 4.5SN BK BX	1386330000	J.25
LXXX 15.00/05/90FR 4.5SN BK BX	1386370000	J.25
LXXX 15.00/06/90 4.5SN BK BX	1386400000	J.24
LXXX 15.00/06/90F 4.5SN BK BX	1386440000	J.25
LXXX 15.00/06/90FL 4.5SN BK BX	1386480000	J.25
LXXX 15.00/06/90FR 4.5SN BK BX	1386520000	J.25
LXXX 15.00/07/90 4.5SN BK BX	1386550000	J.24
LXXX 15.00/07/90F 4.5SN BK BX	1386590000	J.25
LXXX 15.00/07/90FL 4.5SN BK BX	1386630000	J.25
LXXX 15.00/07/90FR 4.5SN BK BX	1386670000	J.25
LXXX 15.00/08/90 4.5SN BK BX	1386700000	J.24
LXXX 15.00/08/90F 4.5SN BK BX	1386740000	J.25
LXXX 15.00/08/90FL 4.5SN BK BX	1386780000	J.25
LXXX 15.00/08/90FR 4.5SN BK BX	1386820000	J.25
LXXX 15.00/09/90 4.5SN BK BX	1386850000	J.24
LXXX 15.00/09/90F 4.5SN BK BX	1386890000	J.25
LXXX 15.00/09/90FL 4.5SN BK BX	1386930000	J.25
LXXX 15.00/09/90FR 4.5SN BK BX	1386970000	J.25

## M

MC2 5	8857560000	N.41
MF 5/7.5 MC NEWS	1877680000	N.17
MHS 6	1925740000	N.40
MHZ 6	1925760000	N.40
MOFU 35/LO/1 SW	0646210000	N.52
MTA 30 BK	1168970000	N.52
MTA 45 BK	1962250000	N.52

## P

PF RS 100 GR 2000MM A.1	4010870000	N.50
PF RS 100 DR 155.5 MM	4148400000	N.50
PF RS 100 DR 2000MM A.1	4144870000	N.50
PF RS 122 DR 2000MM	1155940000	N.51
PF RS 45 GR 1000MM	8140880000	N.46
PF RS 45 GR 2000MM	4027750000	N.46
PF RS 45 DR 2000MM	4340430000	N.48
PF RS 80 GR 2000MM	4183130000	N.48
PF RS 80 DR 2000MM	4154740000	N.48
PF RS 90 GR 2000MM	4051810000	N.49
PF RS 90 DR 2000MM	4053240000	N.49
PGK 4 BK	1288470000	L.11
PGK 4 BT BK	1289590000	L.10
PM 5.00/02/90 3.5SN DR BX	1791610000	C.46
PM 5.00/03/90 3.5SN DR BX	1791620000	C.46

Type	Order No.	Page
PM 5.00/04/90 3.5SN DR BX	1234650000	C.46
PM 5.00/05/90 3.5SN DR BX	1234670000	C.46
PM 5.00/06/90 3.5SN DR BX	1234680000	C.46
PM 5.00/07/90 3.5SN DR BX	1234690000	C.46
PM 5.00/08/90 3.5SN DR BX	1234700000	C.46
PM 5.00/09/90 3.5SN DR BX	1234710000	C.46
PM 5.00/10/90 3.5SN DR BX	1234720000	C.46
PM 5.00/11/90 3.5SN DR BX	1234730000	C.46
PM 5.00/12/90 3.5SN DR BX	1234740000	C.46
PM 5.08/02/90 3.5SN DR BX	1760490000	C.47
PM 5.08/03/90 3.5SN DR BX	1760500000	C.47
PM 5.08/04/90 3.5SN DR BX	1234550000	C.47
PM 5.08/05/90 3.5SN DR BX	1234570000	C.47
PM 5.08/06/90 3.5SN DR BX	1234580000	C.47
PM 5.08/07/90 3.5SN DR BX	1234590000	C.47
PM 5.08/08/90 3.5SN DR BX	1234600000	C.47
PM 5.08/09/90 3.5SN DR BX	1234610000	C.47
PM 5.08/10/90 3.5SN DR BX	1234620000	C.47
PM 5.08/11/90 3.5SN DR BX	1234630000	C.47
PM 5.08/12/90 3.5SN DR BX	1234640000	C.47
PS 2.0 MC	0310000000	C.90
PS 2.0 MC	0310000000	C.92
PS 2.0 MC	0310000000	C.95
PS 2.0 MC	0310000000	C.92
PS 2.0 MC	0310000000	J.20
PS 2.0 MC	0310000000	J.21
PS 2.0 MC	0310000000	J.22
PS 2.0 MC	0310000000	J.24
PS 2.0 MC	0310000000	J.26
PS 2.0 MC	0310000000	J.27
PS 2.0 MC	0310000000	J.28
PS 2.0 MC	0310000000	J.29
PS 2.0 MC	0310000000	J.30
PS 2.0 MC	0310	

Type	Order No.	Page
RSV1,6 LBF6 GR 3,2 SN	1441700000	H.9
RSV1,6 LBF9 GR 3,2 AU	1442600000	H.13
RSV1,6 LBF9 GR 3,2 SN	1442700000	H.9
RSV1,6 LS12 GR 3,2 AU	1443400000	H.10
RSV1,6 LS12 GR 3,2 SN	1443500000	H.6
RSV1,6 LS18 GR 3,2 AU	1444400000	H.10
RSV1,6 LS18 GR 3,2 SN	1444500000	H.6
RSV1,6 LS24 GR 3,2 AU	1445400000	H.10
RSV1,6 LS24 GR 3,2 SN	1445500000	H.6
RSV1,6 LS36 GR 3,2 AU	1446400000	H.10
RSV1,6 LS36 GR 3,2 SN	1446500000	H.6
RSV1,6 LS4 GR 3,2 AU	1440400000	H.10
RSV1,6 LS4 GR 3,2 SN	1440500000	H.6
RSV1,6 LS6 GR 3,2 AU	1441400000	H.10
RSV1,6 LS6 GR 3,2 SN	1441500000	H.6
RSV1,6 LS9 GR 3,2 AU	1442400000	H.10
RSV1,6 LS9 GR 3,2 SN	1442500000	H.6
RSV1,6 LSF12 GR 3,2 AU	1443800000	H.11
RSV1,6 LSF12 GR 3,2 SN	1443900000	H.7
RSV1,6 LSF18 GR 3,2 AU	1444800000	H.11
RSV1,6 LSF18 GR 3,2 SN	1444900000	H.7
RSV1,6 LSF24 GR 3,2 AU	1445800000	H.11
RSV1,6 LSF24 GR 3,2 SN	1445900000	H.7
RSV1,6 LSF36 GR 3,2 AU	1446800000	H.11
RSV1,6 LSF36 GR 3,2 SN	1446900000	H.7
RSV1,6 LSF4 GR 3,2 AU	1440800000	H.11
RSV1,6 LSF4 GR 3,2 SN	1440900000	H.7
RSV1,6 LSF6 GR 3,2 AU	1441800000	H.11
RSV1,6 LSF6 GR 3,2 SN	1441900000	H.7
RSV1,6 LSF9 GR 3,2 AU	1442800000	H.11
RSV1,6 LSF9 GR 3,2 SN	1442900000	H.7
RSV1,6 RF12/35x15 SW	1690140000	H.14
RSV1,6 RF12/35x15 SW	1690140000	I.3
RSV1,6 RF12/35x7.5 SW	1582940000	H.13
RSV1,6 RF12/35x7.5 SW	1582940000	I.4
RSV1,6 RF18/35x15 SW	1690150000	H.14
RSV1,6 RF18/35x15 SW	1690150000	I.3
RSV1,6 RF18/35x7.5 SW	1582950000	H.13
RSV1,6 RF18/35x7.5 SW	1582950000	I.4
RSV1,6 RF24/35x15 SW	1690160000	H.14
RSV1,6 RF24/35x15 SW	1690160000	I.3
RSV1,6 RF24/35x7.5 SW	1582960000	H.13
RSV1,6 RF24/35x7.5 SW	1582960000	I.4
RSV1,6 RF36/35x15 SW	1690170000	H.14
RSV1,6 RF36/35x15 SW	1690170000	I.3
RSV1,6 RF36/35x7.5 SW	1582970000	H.13
RSV1,6 RF36/35x7.5 SW	1582970000	I.4
RSV1,6 RF4/35x15 SW	1690110000	H.14
RSV1,6 RF4/35x15 SW	1690110000	I.3
RSV1,6 RF4/35x7.5 SW	1582910000	H.14
RSV1,6 RF4/35x7.5 SW	1582910000	I.3
RSV1,6 RF6/35x15 SW	1690120000	H.14
RSV1,6 RF6/35x15 SW	1690120000	I.3
RSV1,6 RF6/35x7.5 SW	1582920000	H.13
RSV1,6 RF6/35x7.5 SW	1582920000	I.4
RSV1,6 RF9/35x15 SW	1690130000	H.14
RSV1,6 RF9/35x15 SW	1690130000	I.3
RSV1,6 RF9/35x7.5 SW	1582930000	H.13
RSV1,6 RF9/35x7.5 SW	1582930000	I.4
RSV1,6 S12 GR	1411610000	H.14
RSV1,6 S18 GR	1411700000	H.14
RSV1,6 S24 GR	1411800000	H.14
RSV1,6 S36 GR BX	1411910000	H.14
RSV1,6 S4 GR	1411310000	H.14
RSV1,6 S6 GR	1411410000	H.14
RSV1,6 S9 GR	1411510000	H.14
RSV1,6 ZE04 BK BX	1563600000	H.14
RSV1,6 ZE04 BK BX	1563600000	I.3
RSV1,6 ZE06 BK BX	1563500000	H.13
RSV1,6 ZE06 BK BX	1563500000	I.4
RSV1,6 ZE09 BK BX	1563400000	H.13
RSV1,6 ZE09 BK BX	1563400000	I.3
RSV1,6 ZE12 BK BX	1563300000	H.14
RSV1,6 ZE12 BK BX	1563300000	I.3
RSV1,6 ZE18 BK BX	1563200000	H.14
RSV1,6 ZE18 BK BX	1563200000	I.3
RSV1,6 ZE24 BK BX	1563100000	H.14
RSV1,6 ZE24 BK BX	1563100000	I.3
RSV1,6 ZE36 BK BX	1563000000	H.14
RSV1,6 ZE36 BK BX	1563000000	I.3

### S

S2C-SMT 3.50/04/180G 1.5SN BK RL	1358680000	E.9
S2C-SMT 3.50/04/180G 3.2SN BK BX	1290300000	E.8
S2C-SMT 3.50/04/180L 1.5SN BK RL	1358630000	E.9
S2C-SMT 3.50/04/180L 3.2SN BK BX	1290220000	E.9
S2C-SMT 3.50/04/90G 1.5SN BK RL	1359580000	E.7
S2C-SMT 3.50/04/90G 3.2SN BK BX	1289890000	E.6
S2C-SMT 3.50/04/90LF 1.5SN BK RL	1359080000	E.7
S2C-SMT 3.50/04/90LF 3.2SN BK BX	1289450000	E.7
S2C-SMT 3.50/06/180G 1.5SN BK RL	1358870000	E.9
S2C-SMT 3.50/06/180G 3.2SN BK BX	1290040000	E.8
S2C-SMT 3.50/06/180L 1.5SN BK RL	1358900000	E.9
S2C-SMT 3.50/06/180L 3.2SN BK BX	1290320000	E.9
S2C-SMT 3.50/06/90G 1.5SN BK RL	1359590000	E.7
S2C-SMT 3.50/06/90G 3.2SN BK BX	1289700000	E.6
S2C-SMT 3.50/06/90LF 1.5SN BK RL	1359690000	E.7
S2C-SMT 3.50/06/90LF 3.2SN BK BX	1289700000	E.6
S2C-SMT 3.50/06/90F 1.5SN BK RL	1359090000	E.7
S2C-SMT 3.50/06/90F 3.2SN BK BX	1289700000	E.6
S2C-SMT 3.50/06/90G 3.2SN BK BX	1289400000	E.6
S2C-SMT 3.50/06/90G 1.5SN BK RL	1359610000	E.7
S2C-SMT 3.50/06/90L 1.5SN BK RL	1290210000	E.9
S2C-SMT 3.50/06/90L 3.2SN BK BX	1290330000	E.9
S2C-SMT 3.50/06/90G 3.2SN BK BX	1289800000	E.6
S2C-SMT 3.50/06/90G 1.5SN BK RL	1359590000	E.7
S2C-SMT 3.50/06/90G 3.2SN BK BX	1289400000	E.6
S2C-SMT 3.50/06/90L 3.2SN BK BX	1289620000	E.7
S2C-SMT 3.50/06/90L 1.5SN BK RL	1359790000	E.10
S2C-SMT 3.50/06/180L 1.5SN BK RL	1358640000	E.9
S2C-SMT 3.50/06/180L 3.2SN BK BX	1290230000	E.9
S2C-SMT 3.50/06/90G 1.5SN BK RL	1359590000	E.7
S2C-SMT 3.50/06/90G 3.2SN BK BX	1289700000	E.6
S2C-SMT 3.50/06/90L 1.5SN BK RL	1359090000	E.7
S2C-SMT 3.50/06/90L 3.2SN BK BX	1289460000	E.7

Type	Order No.	Page
S2C-SMT 3.50/08/180G 1.5SN BK RL	1358880000	E.9
S2C-SMT 3.50/08/180G 3.2SN BK BX	1290050000	E.8
S2C-SMT 3.50/08/180L 1.5SN BK RL	1358650000	E.9
S2C-SMT 3.50/08/180L 3.2SN BK BX	1290240000	E.9
S2C-SMT 3.50/08/90G 1.5SN BK RL	1359600000	E.7
S2C-SMT 3.50/08/90G 3.2SN BK BX	1289280000	E.6
S2C-SMT 3.50/08/90LF 1.5SN BK RL	1359110000	E.7
S2C-SMT 3.50/08/90LF 3.2SN BK BX	1289470000	E.7
S2C-SMT 3.50/10/180G 1.5SN BK RL	1358900000	E.9
S2C-SMT 3.50/10/180G 3.2SN BK BX	1290060000	E.8
S2C-SMT 3.50/10/180L 1.5SN BK RL	1358670000	E.9
S2C-SMT 3.50/10/180L 3.2SN BK BX	1290250000	E.9
S2C-SMT 3.50/10/90G 1.5SN BK RL	1359610000	E.7
S2C-SMT 3.50/10/90G 3.2SN BK BX	1289290000	E.6
S2C-SMT 3.50/10/90LF 1.5SN BK RL	1359120000	E.7
S2C-SMT 3.50/10/90LF 3.2SN BK BX	1289480000	E.7
S2C-SMT 3.50/12/180G 1.5SN BK RL	1358920000	E.8
S2C-SMT 3.50/12/180G 3.2SN BK BX	1290070000	E.9
S2C-SMT 3.50/12/180LF 1.5SN BK RL	1358680000	E.9
S2C-SMT 3.50/12/180LF 3.2SN BK BX	1290260000	E.9
S2C-SMT 3.50/12/90G 1.5SN BK RL	1359620000	E.7
S2C-SMT 3.50/12/90G 3.2SN BK BX	1289300000	E.6
S2C-SMT 3.50/12/90LF 1.5SN BK RL	1359130000	E.7
S2C-SMT 3.50/12/90LF 3.2SN BK BX	1289490000	E.7
S2C-SMT 3.50/14/180G 1.5SN BK RL	1358940000	E.9
S2C-SMT 3.50/14/180G 3.2SN BK BX	1290080000	E.8
S2C-SMT 3.50/14/180L 1.5SN BK RL	1358690000	E.9
S2C-SMT 3.50/14/180L 3.2SN BK BX	1290270000	E.9
S2C-SMT 3.50/14/90G 1.5SN BK RL	1359630000	E.7
S2C-SMT 3.50/14/90G 3.2SN BK BX	1289310000	E.6
S2C-SMT 3.50/14/90LF 1.5SN BK RL	1359140000	E.7
S2C-SMT 3.50/14/90LF 3.2SN BK BX	1289500000	E.7
S2C-SMT 3.50/16/180G 1.5SN BK RL	1358970000	E.9
S2C-SMT 3.50/16/180G 3.2SN BK BX	1290090000	E.8
S2C-SMT 3.50/16/180L 1.5SN BK RL	1358700000	E.9
S2C-SMT 3.50/16/180L 3.2SN BK BX	1290280000	E.9
S2C-SMT 3.50/16/90G 1.5SN BK RL	1359640000	E.7
S2C-SMT 3.50/16/90G 3.2SN BK BX	1289320000	E.6
S2C-SMT 3.50/16/90LF 1.5SN BK RL	1359150000	E.7
S2C-SMT 3.50/16/90LF 3.2SN BK BX	1289510000	E.7
S2C-SMT 3.50/16/180G 3.2SN BK BX	1289510000	E.7
S2C-SMT 3.50/16/180G 1.5SN BK RL	1358980000	E.9
S2C-SMT 3.50/18/180G 1.5SN BK RL	1290110000	E.8
S2C-SMT 3.50/18/180L 1.5SN BK RL	1358710000	E.9
S2C-SMT 3.50/18/180L 3.2SN BK BX	1290290000	E.9
S2C-SMT 3.50/18/90G 1.5SN BK RL	1359650000	E.7
S2C-SMT 3.50/18/90G 3.2SN BK BX	1289330000	E.6
S2C-SMT 3.50/18/90LF 1.5SN BK RL	1359160000	E.7
S2C-SMT 3.50/18/90LF 3.2SN BK BX	1289520000	E.7
S2C-SMT 3.50/20/180G 1.5SN BK RL	1359020000	E.9
S2C-SMT 3.50/20/180G 3.2SN BK BX	1290120000	E.8
S2C-SMT 3.50/20/180L 1.5SN BK RL	1358720000	E.9
S2C-SMT 3.50/20/180L 3.2SN BK BX	1290310000	E.9
S2C-SMT 3.50/20/90G 1.5SN BK RL	1359660000	E.7
S2C-SMT 3.50/20/90G 3.2SN BK BX	1289340000	E.6
S2C-SMT 3.50/20/90LF 1.5SN BK RL	1359170000	E.7
S2C-SMT 3.50/20/90LF 3.2SN BK BX	1289530000	E.7
S2C-SMT 3.50/22/180G 1.5SN BK RL	1359040000	E.9
S2C-SMT 3.50/22/180G 3.2SN BK BX	1290300000	E.9
S2C-SMT 3.50/22/180L 1.5SN BK RL	1358730000	E.9
S2C-SMT 3.50/22/180L 3.2SN BK BX	1290320000	E.9
S2C-SMT 3.50/22/90G 1.5SN BK RL	1359670000	E.7
S2C-SMT 3.50/22/90G 3.2SN BK BX	1289350000	E.6
S2C-SMT 3.50/22/90LF 1.5SN BK RL	1359180000	E.7
S2C-SMT 3.50/22/90LF 3.2SN BK BX	1289540000	E.7
S2C-SMT 3.50/24/180G 1.5SN BK RL	1359030000	E.9
S2C-SMT 3.50/24/180G 3.2SN BK BX	1290130000	E.8
S2C-SMT 3.50/24/180L 1.5SN BK RL	1358740000	E.9
S2C-SMT 3.50/24/180L 3.2SN BK BX	1290330000	E.9
S2C-SMT 3.50/24/90G 1.5SN BK RL	1359680000	E.7
S2C-SMT 3.50/24/90G 3.2SN BK BX	1289360000	E.6
S2C-SMT 3.50/24/90LF 1.5SN BK RL	1359190000	E.7
S2C-SMT 3.50/24/90LF 3.2SN BK BX	1289550000	E.7
S2C-SMT 3.50/26/180G 1.5SN BK RL	1290140000	E.8
S2C-SMT 3.50/26/180G 3.2SN BK BX	1290340000	E.9
S2C-SMT 3.50/26/180L 1.5SN BK RL	1290340000	E.9
S2C-SMT 3.50/26/180L 3.2SN BK BX	1290380000	E.9
S2C-SMT 3.50/26/90G 1.5SN BK RL	1289570000	E.7
S2C-SMT 3.50/26/90G 3.2SN BK BX	1289570000	E.6
S2C-SMT 3.50/26/90LF 1.5SN BK RL	1290160000	E.8
S2C-SMT 3.50/26/90LF 3.2SN BK BX	1290350000	E.9
S2C-SMT 3.50/28/180G 1.5SN BK RL	1290350000	E.9
S2C-SMT 3.50/28/180L 1.5SN BK RL	1289390000	E.6
S2C-SMT 3.50/28/90G 3.2SN BK BX	1289580000	E.7
S2C-SMT 3.50/28/90LF 3.2SN BK BX	1289580000	E.7
S2C-SMT 3.50/30/180G 3.2SN BK BX	1290170000	E.8
S2C-SMT 3.50/30/180L 3.2SN BK BX	1290360000	E.9
S2C-SMT 3.50/30/90G 3.2SN BK BX	1289410000	E.6
S2C-SMT 3.50/30/90L 3.2SN BK BX	1289590000	E.7
S2C-SMT 3.50/32/180G 3.2SN BK BX	1290180000	E.8
S2C-SMT 3.50/32/180L 3.2SN BK BX	1290370000	E.9
S2C-SMT 3.50/32/90G 3.2SN BK BX	1289420000	E.6
S2C-SMT 3.50/32/90LF 3.2SN BK BX	1289600000	E.7
S2C-SMT 3.50/32/90G 1.5SN BK RL	1290190000	E.8
S2C-SMT 3.50/32/90G 3.2SN BK BX	1290380000	E.9
S2C-SMT 3.50/34/180L 3.2SN BK BX	1290380000	E.9
S2C-SMT 3.50/34/90G 3.2SN BK BX	1289430000	E.6
S2C-SMT 3.50/34/90LF 3.2SN BK BX	1289610000	E.7
S2C-SMT 3.50/36/180G 3.2SN BK BX	1290210000	E.9
S2C-SMT 3.50/36/180L 3.2SN BK BX	1290390000	E.9
S2C-SMT 3.50/36/90G 3.2SN BK BX	1289440000	E.6
S2C-SMT 3.50/36/90G 1.5SN BK RL	1289620000	E.7
S2C-SMT 3.50/36/90L 3.2SN BK BX	1289790000	E.10
S2C-SMT 3.50/36/90LF 3.2SN BK BX	1357890000	E.11
S2C-SMT 3.50/36/12/90G 3.2SN BK BX	1357800000	E.10
S2C-SMT 3.50/36/12/90LF 3.2SN BK BX	1357900000	E.11
S2C-SMT 3.50/36/90G 3.2SN BK BX	1357820000	E.10
S2C-SMT 3.50/36/90L 3.2SN BK BX	1357920000	E.11
S2C-SMT 3.50/36/90L 1.5SN BK RL	1357920000	E.11
S2C-SMT 3.50/36/90LF 3.2SN BK BX	1357830000	E.10

Type	Order No.	Page
S2CD-THR 3.50/20/90LF 3.2SN BK BX	1357930000	E.11
S2CD-THR 3.50/24/90G 3.2SN BK BX	1357840000	E.10
S2CD-THR 3.50/24/90LF 3.2SN BK BX	1357940000	E.11
S2CD-THR 3.50/28/90G 3.2SN BK BX	1357850000	E.10
S2CD-THR 3.50/28/90LF 3.2SN BK BX	1357950000	E.11
S2CD-THR 3.50/32/90G 3.2SN BK BX	1357870000	E.10
S2CD-THR 3.50/32/90LF 3.2SN BK BX	1357970000	E.11
S2CD-THR 3.50/36/90G 3.2SN BK BX	1357880000	E.10
S2CD-THR 3.		



Type	Order No.	Page	Type	Order No.	Page	Type	Order No.	Page	Type	Order No.	Page
SCDV 3.81/14/180G 3.2SN DR BX	1034540000	F.42	SCZ 3.81/02/180F SN DR BX	1970910000	F.45	SDIS 0.4X2.5X75	9008370000	C.60	SDIS 0.8X4.0X100	9008400000	J.28
SCDV 3.81/14/90F 3.2SN DR BX	1032630000	F.41	SCZ 3.81/02/180FI SN DR BX	1970260000	F.45	SDIS 0.4X2.5X75	9008370000	C.62	SDIS 0.8X4.0X100	9008400000	J.29
SCDV 3.81/14/90G 3.2SN DR BX	1032150000	F.40	SCZ 3.81/02/180G SN DR BX	1969520000	F.44	SDIS 0.4X2.5X75	9008370000	C.64	SDIS 0.8X4.0X100	9008400000	J.30
SCDV 3.81/16/180F 3.2SN DR BX	1035050000	F.43	SCZ 3.81/02/180LR SN DR BX	2442000000	F.45	SDIS 0.4X2.5X75	9008370000	C.66	SDIS 0.8X4.0X100	9008400000	J.31
SCDV 3.81/16/180G 3.2SN DR BX	1034550000	F.42	SCZ 3.81/03/180F SN DR BX	1970290000	F.45	SDIS 0.4X2.5X75	9008370000	C.68	SDIS 0.8X4.0X100	9008400000	J.32
SCDV 3.81/16/90F 3.2SN DR BX	1032640000	F.41	SCZ 3.81/03/180FI SN DR BX	1970270000	F.45	SDIS 0.4X2.5X75	9008370000	C.70	SDIS 0.8X4.0X100	9008400000	J.33
SCDV 3.81/16/90G 3.2SN DR BX	1032160000	F.40	SCZ 3.81/03/180G SN DR BX	1969540000	F.44	SDIS 0.4X2.5X75	9008370000	C.72	SDIS 0.8X4.0X100	9008400000	J.34
SCDV 3.81/18/180F 3.2SN DR BX	1035060000	F.43	SCZ 3.81/03/180LR SN DR BX	2444060000	F.45	SDIS 0.4X2.5X75	9008370000	C.74	SDIS 0.8X4.0X100	9008400000	J.35
SCDV 3.81/18/180G 3.2SN DR BX	1034560000	F.42	SCZ 3.81/04/180F SN DR BX	1970930000	F.45	SDIS 0.4X2.5X75	9008370000	C.76	SDIS 0.8X4.0X100	9008400000	J.36
SCDV 3.81/18/90F 3.2SN DR BX	1032650000	F.41	SCZ 3.81/04/180FI SN DR BX	1970310000	F.45	SDIS 0.4X2.5X75	9008370000	C.78	SDIS 0.8X4.0X100	9008400000	J.37
SCDV 3.81/18/90G 3.2SN DR BX	1032170000	F.40	SCZ 3.81/04/180FZE SN DR BX	1237550000	F.47	SDIS 0.4X2.5X75	9008370000	C.80	SDIS 0.8X4.0X100	9008400000	J.38
SCDV 3.81/20/180F 3.2SN DR BX	1035070000	F.43	SCZ 3.81/04/180FZE SN DR BX	1237120000	F.47	SDIS 0.4X2.5X75	9008370000	C.82	SDIS 0.8X4.0X100	9008400000	J.39
SCDV 3.81/20/180G 3.2SN DR BX	1034570000	F.42	SCZ 3.81/04/180G SN DR BX	1969560000	F.44	SDIS 0.4X2.5X75	9008370000	C.84	SDIS 0.8X4.0X100	9008400000	J.40
SCDV 3.81/20/90F 3.2SN DR BX	1032660000	F.41	SCZ 3.81/04/180GZE SN DR BX	1237000000	F.46	SDIS 0.4X2.5X75	9008370000	C.86	SDIS 0.8X4.0X100	9008400000	J.41
SCDV 3.81/20/90G 3.2SN DR BX	1032190000	F.40	SCZ 3.81/04/180LR SN DR BX	2444090000	F.45	SDIS 0.4X2.5X75	9008370000	C.88	SDIS 0.8X4.0X100	9008400000	L.14
SCDV 3.81/22/180F 3.2SN DR BX	1035080000	F.43	SCZ 3.81/04/180LRZE SN DR BX	2442400000	F.47	SDIS 0.4X2.5X75	9008370000	C.94	SDIS 0.8X4.0X100	9008400000	L.16
SCDV 3.81/22/180G 3.2SN DR BX	1034580000	F.42	SCZ 3.81/05/180F SN DR BX	1970940000	F.45	SDIS 0.4X2.5X75	9008370000	E.48	SDIS 0.8X4.0X100	9008400000	M.5
SCDV 3.81/22/90F 3.2SN DR BX	1032670000	F.41	SCZ 3.81/05/180FI SN DR BX	1970320000	F.45	SDIS 0.4X2.5X75	9008370000	E.50	SDIS 0.8X4.0X100	9008400000	M.5.3
SCDV 3.81/22/90G 3.2SN DR BX	1032200000	F.40	SCZ 3.81/05/180FZE SN DR BX	1237560000	F.47	SDIS 0.4X2.5X75	9008370000	E.54	SDIS 1.0X4.5X125	9008910000	L.22
SCDV 3.81/24/180F 3.2SN DR BX	1035090000	F.43	SCZ 3.81/05/180FZE SN DR BX	1237130000	F.47	SDIS 0.4X2.5X75	9008370000	E.56	SDIS 1.0X4.5X125	9008910000	M.5
SCDV 3.81/24/180G 3.2SN DR BX	1034590000	F.42	SCZ 3.81/05/180G SN DR BX	1969570000	F.44	SDIS 0.4X2.5X75	9008370000	E.58	SDIS 1.0X4.5X125	9008910000	N.5.3
SCDV 3.81/24/90F 3.2SN DR BX	1032680000	F.41	SCZ 3.81/05/180GZE SN DR BX	1237010000	F.46	SDIS 0.4X2.5X75	9008370000	E.60	SDIS 1.0X5.5X125	9008410000	L.22
SCDV 3.81/24/90G 3.2SN DR BX	1032210000	F.40	SCZ 3.81/05/180LR SN DR BX	2444100000	F.45	SDIS 0.4X2.5X75	9008370000	E.62	SDIS 1.0X5.5X125	9008410000	J.18
SCDV 3.81/26/180F 3.2SN DR BX	1035110000	F.43	SCZ 3.81/05/180LRZE SN DR BX	2444220000	F.47	SDIS 0.4X2.5X75	9008370000	F.44	SDIS 1.0X5.5X125	9008410000	J.19
SCDV 3.81/26/180G 3.2SN DR BX	1034610000	F.42	SCZ 3.81/06/180F SN DR BX	1970960000	F.45	SDIS 0.4X2.5X75	9008370000	F.46	SDIS 1.0X5.5X125	9008410000	J.20
SCDV 3.81/26/90F 3.2SN DR BX	1032690000	F.41	SCZ 3.81/06/180FI SN DR BX	1970340000	F.45	SDIS 0.4X2.5X75	9008370000	F.48	SDIS 1.0X5.5X125	9008410000	J.21
SCDV 3.81/26/90G 3.2SN DR BX	1032220000	F.40	SCZ 3.81/06/180FZE SN DR BX	1237570000	F.47	SDIS 0.4X2.5X75	9008370000	F.50	SDIS 1.0X5.5X125	9008410000	K.70
SCDV 3.81/28/180F 3.2SN DR BX	1035120000	F.43	SCZ 3.81/06/180FZE SN DR BX	1237140000	F.47	SDIS 0.4X2.5X75	9008370000	F.52	SDIS 1.0X6.5X150	9008420000	K.196
SCDV 3.81/28/180G 3.2SN DR BX	1034620000	F.42	SCZ 3.81/06/180G SN DR BX	1969580000	F.44	SDIS 0.4X2.5X75	9008370000	F.54	SDIS 1.0X6.5X150	9008410000	L.198
SCDV 3.81/28/90F 3.2SN DR BX	1032710000	F.41	SCZ 3.81/06/180GZE SN DR BX	1237020000	F.46	SDIS 0.4X2.5X75	9008370000	F.56	SDIS 1.0X5.5X125	9008410000	K.198
SCDV 3.81/28/90G 3.2SN DR BX	1032230000	F.40	SCZ 3.81/06/180LR SN DR BX	2444110000	F.45	SDIS 0.4X2.5X75	9008370000	L.22	SDIS 1.0X5.5X125	9008410000	M.5
SCDV 3.81/30/180F 3.2SN DR BX	1035130000	F.43	SCZ 3.81/06/180LRZE SN DR BX	2444270000	F.47	SDIS 0.4X2.5X75	9008370000	M.5	SDIS 1.0X5.5X125	9008410000	M.5.3
SCDV 3.81/30/180G 3.2SN DR BX	1034630000	F.42	SCZ 3.81/07/180F SN DR BX	1970970000	F.45	SDIS 0.4X2.5X75	9008370000	N.53	SDIS 1.2X6.5X150	9008420000	L.22
SCDV 3.81/30/90F 3.2SN DR BX	1032720000	F.41	SCZ 3.81/07/180FI SN DR BX	1970350000	F.45	SDIS 0.5X3.0X100	9008380000	L.22	SDIS 1.2X6.5X150	9008420000	J.22
SCDV 3.81/30/90G 3.2SN DR BX	1032240000	F.40	SCZ 3.81/07/180FZE SN DR BX	1237580000	F.47	SDIS 0.5X3.0X100	9008380000	J.26	SDIS 1.2X6.5X150	9008420000	J.24
SCDV 3.81/32/180F 3.2SN DR BX	1035140000	F.43	SCZ 3.81/07/180FZE SN DR BX	1237170000	F.47	SDIS 0.5X3.0X100	9008380000	J.27	SDIS 1.2X6.5X150	9008420000	L.20
SCDV 3.81/32/180G 3.2SN DR BX	1034640000	F.42	SCZ 3.81/07/180G SN DR BX	1969590000	F.44	SDIS 0.5X3.0X100	9008380000	K.94	SDIS 1.2X6.5X150	9008420000	L.22
SCDV 3.81/32/90F 3.2SN DR BX	1032730000	F.41	SCZ 3.81/07/180GZE SN DR BX	1237030000	F.46	SDIS 0.5X3.0X100	9008380000	M.5	SDIS 1.2X6.5X150	9008420000	M.5
SCDV 3.81/32/90G 3.2SN DR BX	1032250000	F.40	SCZ 3.81/07/180LR SN DR BX	2444120000	F.45	SDIS 0.5X3.0X100	9008380000	N.53	SDIS 1.2X6.5X150	9008420000	N.5.3
SCDV-THR 3.81/04/180F 3.2SN BK BX	1035950000	F.25	SCZ 3.81/07/180LRZE SN DR BX	2444200000	F.47	SDIS 0.6X3.5X100	9008390000	C.18	SDIS 1.6X8.0X175	9008430000	L.22
SCDV-THR 3.81/04/180G 3.2SN BK BX	1035470000	F.24	SCZ 3.81/08/180F SN DR BX	1970980000	F.45	SDIS 0.6X3.5X100	9008390000	C.20	SDIS 1.6X8.0X175	9008430000	M.5
SCDV-THR 3.81/04/90F 3.2SN BK BX	1033970000	F.23	SCZ 3.81/08/180FI SN DR BX	1970360000	F.45	SDIS 0.6X3.5X100	9008390000	C.22	SDIS 1.6X8.0X175	9008430000	N.5.3
SCDV-THR 3.81/04/90G 3.2SN BK BX	1033490000	F.22	SCZ 3.81/08/180FZE SN DR BX	1237590000	F.47	SDIS 0.6X3.5X100	9008390000	C.24	SDK PHO	9008470000	L.22
SCDV-THR 3.81/06/180F 3.2SN BK BX	1035960000	F.25	SCZ 3.81/08/180FZE SN DR BX	1237180000	F.47	SDIS 0.6X3.5X100	9008390000	C.26	SDK PHO	9008470000	M.5
SCDV-THR 3.81/06/180G 3.2SN BK BX	1035480000	F.24	SCZ 3.81/08/180G SN DR BX	1969610000	F.44	SDIS 0.6X3.5X100	9008390000	C.28	SDK PHO	9008470000	N.5.3
SCDV-THR 3.81/06/90F 3.2SN BK BX	1033980000	F.23	SCZ 3.81/08/180GZE SN DR BX	1237040000	F.46	SDIS 0.6X3.5X100	9008390000	C.30	SDK PHI	9008480000	G.40
SCDV-THR 3.81/06/90G 3.2SN BK BX	1033510000	F.22	SCZ 3.81/08/180LR SN DR BX	2444130000	F.45	SDIS 0.6X3.5X100	9008390000	C.32	SDK PHI	9008480000	G.42
SCDV-THR 3.81/08/180F 3.2SN BK BX	1035970000	F.25	SCZ 3.81/08/180LRZE SN DR BX	2444260000	F.47	SDIS 0.6X3.5X100	9008390000	C.36	SDK PHI	9008480000	G.44
SCDV-THR 3.81/08/180G 3.2SN BK BX	1035490000	F.24	SCZ 3.81/09/180F SN DR BX	1970990000	F.45	SDIS 0.6X3.5X100	9008390000	C.38	SDK PHI	9008480000	G.104
SCDV-THR 3.81/08/90F 3.2SN BK BX	1033990000	F.23	SCZ 3.81/09/180FI SN DR BX	1970390000	F.45	SDIS 0.6X3.5X100	9008390000	C.40	SDK PHI	9008480000	G.106
SCDV-THR 3.81/08/90G 3.2SN BK BX	1033520000	F.22	SCZ 3.81/09/180FZE SN DR BX	1237610000	F.47	SDIS 0.6X3.5X100	9008390000	C.42	SDK PHI	9008480000	G.108
SCDV-THR 3.81/10/180F 3.2SN BK BX	1035980000	F.25	SCZ 3.81/09/180FZE SN DR BX	1237190000	F.47	SDIS 0.6X3.5X100	9008390000	C.44	SDK PHI	9008480000	G.110
SCDV-THR 3.81/10/180G 3.2SN BK BX	1035510000	F.24	SCZ 3.81/09/180G SN DR BX	1969630000	F.44	SDIS 0.6X3.5X100	9008390000	C.46	SDK PHI	9008480000	L.22
SCDV-THR 3.81/10/90F 3.2SN BK BX	1034010000	F.23	SCZ 3.81/09/180GZE SN DR BX	1237070000	F.46	SDIS 0.6X3.5X100	9008390000	C.47	SDK PHI	9008480000	K.64
SCDV-THR 3.81/10/90G 3.2SN BK BX	1033530000	F.22	SCZ 3.81/09/180LR SN DR BX	2444140000	F.45	SDIS 0.6X3.5X100	9008390000	C.96	SDK PHI	9008480000	K.132
SCDV-THR 3.81/12/180F 3.2SN BK BX	1035990000	F.25	SCZ 3.81/09/180LRZE SN DR BX	2444230000	F.47	SDIS 0.6X3.5X100	9008390000	C.98	SDK PHI	9008480000	K.134
SCDV-THR 3.81/12/180G 3.2SN BK BX	1035520000	F.24	SCZ 3.81/10/180F SN DR BX	1971000000	F.45	SDIS 0.6X3.5X100	9008390000	C.100	SDK PHI	9008480000	K.136
SCDV-THR 3.81/12/90F 3.2SN BK BX	1034020000	F.23	SCZ 3.81/10/180FI SN DR BX	1970410000	F.45	SDIS 0.6X3.5X100	9008390000	C.102	SDK PHI	9008480000	K.138
SCDV-THR 3.81/12/90G 3.2SN BK BX	1033540000	F.22	SCZ 3.81/10/180FZE SN DR BX	1237620000	F.47	SDIS 0.6X3.5X100	9008390000	C.104	SDK PHI	9008480000	K.139
SCDV-THR 3.81/14/180F 3.2SN BK BX	1036010000	F.24	SCZ 3.81/10/180FZE SN DR BX	1237200000	F.47	SDIS 0.6X3.5X100	9008390000	G.42	SDK PHI	9008480000	K.140
SCDV-THR 3.81/14/180G 3.2SN BK BX	1035530000	F.25	SCZ 3.81/10/180G SN DR BX	1969640000	F.44	SDIS 0.6X3.5X100	9008390000	G.44	SDK PHI	9008480000	K.158
SCDV-THR 3.81/14/90F 3.2SN BK BX	1034030000	F.23	SCZ 3.81/10/180GZE SN DR BX	1237080000	F.46	SDIS 0.6X3.5X100	9008390000	G.46	SDK PHI	9008480000	K.160
SCDV-THR 3.81/14/90G 3.2SN BK BX	1033550000	F.22	SCZ 3.81/10/180LR SN DR BX	2444150000	F.45	SDIS 0.6X3.5X100	9008390000	G.48	SDK PHI	9008480000	K.162
SCDV-THR 3.81/16/180F 3.2SN BK BX	1036020000	F.25	SCZ 3.81/10/180LRZE SN DR BX	2442900000	F.47	SDIS 0.6X3.5X100	9008390000	G.86	SDK PHI	9008480000	M.5
SCDV-THR 3.81/16/180G 3.2SN BK BX	1035540000	F.24	SCZ 3.81/11/180F SN DR BX	1971010000	F.45	SDIS 0.6X3.5X100	9008390000	G.88	SDK PHI	9008480000	N.5.3
SCDV-THR 3.81/16/90F 3.2SN BK BX	1034040000	F.23	SCZ 3.81/11/180FI SN DR BX	1970420000	F.45	SDIS 0.6X3.5X100	9008390000	G.90	SDK PH2	9008490000	L.22
SCDV-THR 3.81/16/90G 3.2SN BK BX	1033560000	F.22	SCZ 3.81/11/180FZE SN DR BX	1237630000	F.47	SDIS 0.6X3.5X100	9008390000	G.92	SDK PH2	9008490000	M.5
SCDV-THR 3.81/18/180F 3.2SN BK BX	1036030000	F.25									

Type	Order No.	Page	Type	Order No.	Page	Type	Order No.	Page	Type	Order No.	Page
SDS 0.4X2.5X75	9009030000	C.14	SDS 0.6X3.5X100	9008330000	L.22	SHL-SMT 5.00/026R 1.5RL	1069580000	N.19	SL 2.50/05/906 3.2SN BK BX	2439780000	D.6
SDS 0.4X2.5X75	9009030000	C.15	SDS 0.6X3.5X100	9008330000	K.40	SHL-SMT 5.00/026R 1.5RL	1069580000	N.31	SL 2.50/06/1806 3.2SN BK BX	2439950000	D.7
SDS 0.4X2.5X75	9009030000	C.16	SDS 0.6X3.5X100	9008330000	K.42	SHL-SMT 5.00/026R 3.2BX	1069680000	N.19	SL 2.50/06/906 3.2SN BK BX	2439790000	D.6
SDS 0.4X2.5X75	9009030000	C.17	SDS 0.6X3.5X100	9008330000	K.44	SHL-SMT 5.00/026R 3.2BX	1069680000	N.31	SL 2.50/07/1806 3.2SN BK BX	2439960000	D.7
SDS 0.4X2.5X75	9009030000	C.48	SDS 0.6X3.5X100	9008330000	K.54	SHL-SMT 5.00/026R 3.2RL	1069720000	N.19	SL 2.50/07/906 3.2SN BK BX	2439800000	D.6
SDS 0.4X2.5X75	9009030000	C.50	SDS 0.6X3.5X100	9008330000	K.88	SHL-SMT 5.00/026R 3.2RL	1069720000	N.31	SL 2.50/08/1806 3.2SN BK BX	2439970000	D.7
SDS 0.4X2.5X75	9009030000	C.52	SDS 0.6X3.5X100	9008330000	K.90	SHL-SMT 5.00/036L 1.5BX	1063210000	N.21	SL 2.50/08/906 3.2SN BK BX	2439810000	D.6
SDS 0.4X2.5X75	9009030000	C.54	SDS 0.6X3.5X100	9008330000	K.92	SHL-SMT 5.00/036L 1.5BX	1063210000	N.30	SL 2.50/09/1806 3.2SN BK BX	2439980000	D.7
SDS 0.4X2.5X75	9009030000	C.56	SDS 0.6X3.5X100	9008330000	K.148	SHL-SMT 5.00/036L 1.5RL	1063240000	N.21	SL 2.50/09/906 3.2SN BK BX	2439820000	D.6
SDS 0.4X2.5X75	9009030000	C.58	SDS 0.6X3.5X100	9008330000	K.170	SHL-SMT 5.00/036L 1.5RL	1063240000	N.30	SL 2.50/10/1806 3.2SN BK BX	2439990000	D.7
SDS 0.4X2.5X75	9009030000	C.60	SDS 0.6X3.5X100	9008330000	K.172	SHL-SMT 5.00/036L 4.2BX	1069630000	N.21	SL 2.50/10/906 3.2SN BK BX	2439830000	D.6
SDS 0.4X2.5X75	9009030000	C.62	SDS 0.6X3.5X100	9008330000	M.5	SHL-SMT 5.00/036L 4.2BX	1069630000	N.30	SL 2.50/11/1806 3.2SN BK BX	2440000000	D.7
SDS 0.4X2.5X75	9009030000	C.64	SDS 0.6X3.5X100	9008330000	N.53	SHL-SMT 5.00/036L 4.2RL	1069660000	N.21	SL 2.50/11/906 3.2SN BK BX	2439840000	D.6
SDS 0.4X2.5X75	9009030000	C.66	SDS 0.8X4.0X100	9008340000	C.34	SHL-SMT 5.00/036L 4.2RL	1069660000	N.30	SL 2.50/12/1806 3.2SN BK BX	2440010000	D.7
SDS 0.4X2.5X75	9009030000	C.68	SDS 0.8X4.0X100	9008340000	C.35	SHL-SMT 5.00/036L 5.9BX	1069760000	N.21	SL 2.50/12/906 3.2SN BK BX	2439850000	D.6
SDS 0.4X2.5X75	9009030000	C.70	SDS 0.8X4.0X100	9008340000	L.22	SHL-SMT 5.00/036L 5.9BX	1069760000	N.30	SL 3.5 FLA 1.5/1.75/8	1597630000	E.0
SDS 0.4X2.5X75	9009030000	C.72	SDS 0.8X4.0X100	9008340000	J.16	SHL-SMT 5.00/036L 5.9RL	1069790000	N.21	SL 3.5 FLA 1.5/1.75/8	1597630000	E.32
SDS 0.4X2.5X75	9009030000	C.74	SDS 0.8X4.0X100	9008340000	J.28	SHL-SMT 5.00/036L 5.9RL	1069790000	N.30	SL 3.5 FLA 1.5/1.75/8	1597630000	E.36
SDS 0.4X2.5X75	9009030000	C.76	SDS 0.8X4.0X100	9008340000	J.29	SHL-SMT 5.00/036R 1.5BX	1063140000	N.21	SL 3.5 FLA 1.5/1.75/8	1597630000	I.8
SDS 0.4X2.5X75	9009030000	C.78	SDS 0.8X4.0X100	9008340000	J.30	SHL-SMT 5.00/036R 1.5BX	1063140000	N.31	SL 3.5 FLA 1.5/8	1597510000	E.30
SDS 0.4X2.5X75	9009030000	C.80	SDS 0.8X4.0X100	9008340000	J.31	SHL-SMT 5.00/036R 1.5RL	1063170000	N.21	SL 3.5 FLA 1.5/8	1597510000	E.32
SDS 0.4X2.5X75	9009030000	C.82	SDS 0.8X4.0X100	9008340000	J.32	SHL-SMT 5.00/036R 1.5RL	1063170000	N.31	SL 3.5 FLA 1.5/8	1597510000	E.36
SDS 0.4X2.5X75	9009030000	C.84	SDS 0.8X4.0X100	9008340000	J.33	SHL-SMT 5.00/036R 4.2BX	1069560000	N.21	SL 3.5 FLA 1.5/8	1597510000	I.8
SDS 0.4X2.5X75	9009030000	C.86	SDS 0.8X4.0X100	9008340000	J.34	SHL-SMT 5.00/036R 4.2BX	1069560000	N.31	SL 3.5 FLA 2.3/1.75/8	1597640000	E.30
SDS 0.4X2.5X75	9009030000	C.88	SDS 0.8X4.0X100	9008340000	J.35	SHL-SMT 5.00/036R 4.2RL	1069590000	N.21	SL 3.5 FLA 2.3/1.75/8	1597640000	E.32
SDS 0.4X2.5X75	9009030000	C.94	SDS 0.8X4.0X100	9008340000	J.36	SHL-SMT 5.00/036R 4.2RL	1069590000	N.31	SL 3.5 FLA 2.3/1.75/8	1597640000	E.36
SDS 0.4X2.5X75	9009030000	E.12	SDS 0.8X4.0X100	9008340000	J.37	SHL-SMT 5.00/036R 5.9BX	1069690000	N.21	SL 3.5 FLA 2.3/8	1597640000	I.8
SDS 0.4X2.5X75	9009030000	E.18	SDS 0.8X4.0X100	9008340000	J.38	SHL-SMT 5.00/036R 5.9BX	1069690000	N.31	SL 3.5 FLA 2.3/8	1597520000	E.30
SDS 0.4X2.5X75	9009030000	E.40	SDS 0.8X4.0X100	9008340000	J.39	SHL-SMT 5.00/036R 5.9RL	1069730000	N.21	SL 3.5 FLA 2.3/8	1597520000	E.32
SDS 0.4X2.5X75	9009030000	E.48	SDS 0.8X4.0X100	9008340000	J.40	SHL-SMT 5.00/036R 5.9RL	1069730000	N.31	SL 3.5 FLA 2.3/8	1597520000	E.36
SDS 0.4X2.5X75	9009030000	E.54	SDS 0.8X4.0X100	9008340000	J.41	SHL-SMT 5.00/046L 1.5BX	1063220000	N.23	SL 3.5 FLA 2.3/8	1597520000	I.8
SDS 0.4X2.5X75	9009030000	E.56	SDS 0.8X4.0X100	9008340000	M.5	SHL-SMT 5.00/046L 1.5BX	1063220000	N.25	SL 3.5 FLA 4.0/1.75/8	1597650000	E.30
SDS 0.4X2.5X75	9009030000	E.58	SDS 0.8X4.0X100	9008340000	N.53	SHL-SMT 5.00/046L 1.5RL	1063220000	N.27	SL 3.5 FLA 4.0/1.75/8	1597650000	E.32
SDS 0.4X2.5X75	9009030000	E.60	SDS 0.8X4.5X125	9009020000	L.22	SHL-SMT 5.00/046L 1.5BX	1063220000	N.30	SL 3.5 FLA 4.0/1.75/8	1597650000	E.36
SDS 0.4X2.5X75	9009030000	E.62	SDS 0.8X4.5X125	9009020000	K.32	SHL-SMT 5.00/046L 1.5RL	1063250000	N.23	SL 3.5 FLA 4.0/1.75/8	1597650000	I.8
SDS 0.4X2.5X75	9009030000	F.44	SDS 0.8X4.5X125	9009020000	K.34	SHL-SMT 5.00/046L 1.5RL	1063250000	N.25	SL 3.5 FLA 4.0/8	1597530000	E.30
SDS 0.4X2.5X75	9009030000	F.46	SDS 0.8X4.5X125	9009020000	K.36	SHL-SMT 5.00/046L 1.5RL	1063250000	N.27	SL 3.5 FLA 4.0/8	1597530000	E.32
SDS 0.4X2.5X75	9009030000	F.48	SDS 0.8X4.5X125	9009020000	K.38	SHL-SMT 5.00/046L 1.5RL	1063250000	N.30	SL 3.5 FLA 4.0/8	1597530000	E.36
SDS 0.4X2.5X75	9009030000	F.50	SDS 0.8X4.5X125	9009020000	K.64	SHL-SMT 5.00/046L 4.2BX	1069640000	N.23	SL 3.5 FLA 4.0/8	1597530000	I.8
SDS 0.4X2.5X75	9009030000	F.52	SDS 0.8X4.5X125	9009020000	K.72	SHL-SMT 5.00/046L 4.2BX	1069640000	N.25	SL 3.50/02/135F 3.2SN OR BX	1643330000	E.40
SDS 0.4X2.5X75	9009030000	F.54	SDS 0.8X4.5X125	9009020000	K.74	SHL-SMT 5.00/046L 4.2BX	1069640000	N.27	SL 3.50/02/180 3.2SN OR BX	1604770000	E.38
SDS 0.4X2.5X75	9009030000	F.56	SDS 0.8X4.5X125	9009020000	K.132	SHL-SMT 5.00/046L 4.2BX	1069640000	N.23	SL 3.50/02/180F 3.2SN OR BX	1604770000	E.39
SDS 0.4X2.5X75	9009030000	F.58	SDS 0.8X4.5X125	9009020000	K.134	SHL-SMT 5.00/046L 4.2RL	1069670000	N.23	SL 3.50/02/180G 3.2SN OR BX	1604470000	E.36
SDS 0.4X2.5X75	9009030000	L.10	SDS 0.8X4.5X125	9009020000	K.136	SHL-SMT 5.00/046L 4.2RL	1069670000	N.25	SL 3.50/02/90 3.2SN OR BX	1597210000	E.39
SDS 0.4X2.5X75	9009030000	M.5	SDS 0.8X4.5X125	9009020000	K.138	SHL-SMT 5.00/046L 4.2RL	1069670000	N.27	SL 3.50/02/90F 3.2SN OR BX	1607040000	E.37
SDS 0.4X2.5X75	9009030000	N.53	SDS 0.8X4.5X125	9009020000	K.139	SHL-SMT 5.00/046L 4.2RL	1069670000	N.30	SL 3.50/02/906 3.2SN OR BX	1605070000	E.37
SDS 0.5X3.0X80	9008320000	L.22	SDS 0.8X4.5X125	9009020000	K.140	SHL-SMT 5.00/046L 5.9BX	1069770000	N.23	SL 3.50/03/135F 3.2SN OR BX	1643340000	E.40
SDS 0.5X3.0X80	9008320000	J.26	SDS 0.8X4.5X125	9009020000	K.142	SHL-SMT 5.00/046L 5.9BX	1069770000	N.25	SL 3.50/03/180 3.2SN OR BX	1604780000	E.38
SDS 0.5X3.0X80	9008320000	J.27	SDS 0.8X4.5X125	9009020000	K.144	SHL-SMT 5.00/046L 5.9BX	1069770000	N.27	SL 3.50/03/180F 3.2SN OR BX	1607510000	E.39
SDS 0.5X3.0X80	9008320000	K.94	SDS 0.8X4.5X125	9009020000	K.146	SHL-SMT 5.00/046L 5.9BX	1069770000	N.30	SL 3.50/03/180G 3.2SN OR BX	1604480000	E.39
SDS 0.5X3.0X80	9008320000	L.10	SDS 0.8X4.5X125	9009020000	K.150	SHL-SMT 5.00/046L 5.9RL	1069810000	N.23	SL 3.50/03/90F 3.2SN OR BX	1597220000	E.36
SDS 0.5X3.0X80	9008320000	M.5	SDS 0.8X4.5X125	9009020000	K.152	SHL-SMT 5.00/046L 5.9RL	1069810000	N.25	SL 3.50/03/906 3.2SN OR BX	1607500000	E.37
SDS 0.5X3.0X80	9008320000	N.53	SDS 0.8X4.5X125	9009020000	K.154	SHL-SMT 5.00/046L 5.9RL	1069810000	N.27	SL 3.50/03/906 3.2SN OR BX	1605080000	E.37
SDS 0.6X3.5X100	9008330000	C.18	SDS 0.8X4.5X125	9009020000	K.158	SHL-SMT 5.00/046L 5.9RL	1069810000	N.30	SL 3.50/04/135F 3.2SN OR BX	1643350000	E.40
SDS 0.6X3.5X100	9008330000	C.20	SDS 0.8X4.5X125	9009020000	K.160	SHL-SMT 5.00/046R 1.5BX	1063150000	N.23	SL 3.50/04/180 3.2SN OR BX	1604790000	E.38
SDS 0.6X3.5X100	9008330000	C.22	SDS 0.8X4.5X125	9009020000	K.162	SHL-SMT 5.00/046R 1.5BX	1063150000	N.25	SL 3.50/04/180F 3.2SN OR BX	1607520000	E.39
SDS 0.6X3.5X100	9008330000	C.24	SDS 0.8X4.5X125	9009020000	K.164	SHL-SMT 5.00/046R 1.5BX	1063150000	N.27	SL 3.50/04/180G 3.2SN OR BX	1604490000	E.39
SDS 0.6X3.5X100	9008330000	C.26	SDS 0.8X4.5X125	9009020000	K.166	SHL-SMT 5.00/046R 1.5RL	1063150000	N.31	SL 3.50/04/90 3.2SN OR BX	1597230000	E.36
SDS 0.6X3.5X100	9008330000	C.28	SDS 0.8X4.5X125	9009020000	K.168	SHL-SMT 5.00/046R 1.5RL	1063180000	N.23	SL 3.50/04/90F 3.2SN OR BX	1607060000	E.37
SDS 0.6X3.5X100	9008330000	C.30	SDS 0.8X4.5X125	9009020000	K.200	SHL-SMT 5.00/046R 1.5RL	1063180000	N.25	SL 3.50/04/906 3.2SN OR BX	1605090000	E.37
SDS 0.6X3.5X100	9008330000	C.32	SDS 0.8X4.5X125	9009020000	M.5	SHL-SMT 5.00/046R 1.5RL	1063180000	N.27	SL 3.50/05/135F 3.2SN OR BX	1643360000	E.40
SDS 0.6X3.5X100	9008330000	C.36	SDS 0.8X4.5X125	9009020000	N.53	SHL-SMT 5.00/046R 1.5RL	1063180000	N.31	SL 3.50/05/180 3.2SN OR BX	1604800000	E.38
SDS 0.6X3.5X100	9008330000	C.38	SDS 1.0X5.5X150	9008350000	L.22	SHL-SMT 5.00/046R 4.2BX	1069570000	N.23	SL 3.50/05/180F 3.2SN OR BX	1607530000	E.39
SDS 0.6X3.5X100	9008330000	C.40	SDS 1.0X5.5X150	9008350000	J.18	SHL-SMT 5.00/046R 4.2BX	1069570000	N.25	SL 3.50/05/180G 3.2SN OR BX	1604500000	E.39
SDS 0.6X3.5X100	9008330000	C.42	SDS 1.0X5.5X150	9008350000	J.19	SHL-SMT 5.00/046R 4.2BX	1069570000	N.27	SL 3.50/05/90 3.2SN OR BX	1597240000	E.36
SDS 0.6X3.5X100	9008330000	C.44	SDS 1.0X5.5X150	9008350000	J.20	SHL-SMT 5.00/046R 4.2BX	1069570000	N.31	SL 3.50/05/90F 3.2SN OR BX	1607070000	E.37
SDS 0.6X3.5X100	9008330000	C.92	SDS 1.0X5.5X150	9008350000	J.21	SHL-SMT 5.00/046R 4.2RL	1069610000	N.23	SL 3.50/05/906 3.2SN OR BX	1605100000	E.37
SDS 0.6X3.5X100	9008330										



Type	Order No.	Page	Type	Order No.	Page	Type	Order No.	Page	Type	Order No.	Page
SL 3.50/10/90 3.2SN DR BX	1597290000	E36	SL 3.50/24/90F 3.2SN DR BX	1619840000	E37	SL 5.00/18/135B 3.2SN DR BX	1630640000	G37	SL 5.08HC/07/90G 3.2SN DR BX	1147420000	G73
SL 3.50/10/90F 3.2SN DR BX	1607120000	E37	SL 3.50/24/90G 3.2SN DR BX	1619450000	E37	SL 5.00/18/180 3.2SN DR BX	1581480000	G34	SL 5.08HC/07/90LF 3.2SN DR BX	1149540000	G75
SL 3.50/11/90G 3.2SN DR BX	1605150000	E37	SL 5.00/02/135 3.2SN DR BX	1603250000	G36	SL 5.00/18/180B 3.2SN DR BX	1581940000	G35	SL 5.08HC/08/180 3.2SN DR BX	1146490000	G76
SL 3.50/11/135F 3.2SN DR BX	1643420000	E40	SL 5.00/02/135B 3.2SN DR BX	1630480000	G37	SL 5.00/18/90 3.2SN DR BX	1571280000	G32	SL 5.08HC/08/180G 3.2SN DR BX	1147510000	G77
SL 3.50/11/180 3.2SN DR BX	1604860000	E38	SL 5.00/02/180 3.2SN DR BX	1581320000	G34	SL 5.00/18/90B 3.2SN DR BX	1581020000	G33	SL 5.08HC/08/180F 3.2SN DR BX	1147320000	G78
SL 3.50/11/180F 3.2SN DR BX	1607590000	E39	SL 5.00/02/180B 3.2SN DR BX	1581780000	G35	SL 5.00/19/135 3.2SN DR BX	1630420000	G36	SL 5.08HC/08/180G 3.2SN DR BX	1146870000	G77
SL 3.50/11/180G 3.2SN DR BX	1604560000	E39	SL 5.00/02/90 3.2SN DR BX	1571130000	G32	SL 5.00/19/135B 3.2SN DR BX	1630650000	G37	SL 5.08HC/08/180LF 3.2SN DR BX	1148090000	G79
SL 3.50/11/90 3.2SN DR BX	1597300000	E36	SL 5.00/02/90B 3.2SN DR BX	1580860000	G33	SL 5.00/19/180 3.2SN DR BX	1581490000	G34	SL 5.08HC/08/90 3.2SN DR BX	1146850000	G72
SL 3.50/11/90F 3.2SN DR BX	1607130000	E37	SL 5.00/03/135 3.2SN DR BX	1630260000	G36	SL 5.00/19/180B 3.2SN DR BX	1581950000	G35	SL 5.08HC/08/90B 3.2SN DR BX	1154830000	G73
SL 3.50/11/90G 3.2SN DR BX	1605160000	E37	SL 5.00/03/135B 3.2SN DR BX	1630490000	G37	SL 5.00/19/90 3.2SN DR BX	1571290000	G32	SL 5.08HC/08/90F 3.2SN DR BX	1148810000	G74
SL 3.50/12/135F 3.2SN DR BX	1643430000	E40	SL 5.00/03/180 3.2SN DR BX	1581330000	G34	SL 5.00/19/90B 3.2SN DR BX	1581030000	G33	SL 5.08HC/08/90G 3.2SN DR BX	1147450000	G73
SL 3.50/12/180 3.2SN DR BX	1604870000	E38	SL 5.00/03/180B 3.2SN DR BX	1581790000	G35	SL 5.00/20/135 3.2SN DR BX	1630430000	G36	SL 5.08HC/08/90LF 3.2SN DR BX	1149580000	G75
SL 3.50/12/180F 3.2SN DR BX	1607600000	E39	SL 5.00/03/90 3.2SN DR BX	1571140000	G32	SL 5.00/20/135B 3.2SN DR BX	1630660000	G37	SL 5.08HC/09/180 3.2SN DR BX	1146510000	G76
SL 3.50/12/180G 3.2SN DR BX	1604570000	E39	SL 5.00/03/90B 3.2SN DR BX	1580870000	G33	SL 5.00/20/180 3.2SN DR BX	1581500000	G34	SL 5.08HC/09/180G 3.2SN DR BX	1147540000	G77
SL 3.50/12/90 3.2SN DR BX	1597310000	E36	SL 5.00/04/135 3.2SN DR BX	1630270000	G36	SL 5.00/20/180B 3.2SN DR BX	1581960000	G35	SL 5.08HC/09/180F 3.2SN DR BX	1147350000	G78
SL 3.50/12/90F 3.2SN DR BX	1607140000	E37	SL 5.00/04/135B 3.2SN DR BX	1630500000	G37	SL 5.00/20/90 3.2SN DR BX	1571300000	G32	SL 5.08HC/09/180G 3.2SN DR BX	1146890000	G77
SL 3.50/12/90G 3.2SN DR BX	1605170000	E37	SL 5.00/04/180 3.2SN DR BX	1581340000	G34	SL 5.00/20/90B 3.2SN DR BX	1581040000	G33	SL 5.08HC/09/90F 3.2SN DR BX	1148120000	G79
SL 3.50/13/135F 3.2SN DR BX	1643440000	E40	SL 5.00/04/180B 3.2SN DR BX	1581800000	G35	SL 5.00/21/135 3.2SN DR BX	1630440000	G36	SL 5.08HC/09/180F 3.2SN DR BX	1146880000	G72
SL 3.50/13/180 3.2SN DR BX	1604880000	E38	SL 5.00/04/90 3.2SN DR BX	1571150000	G32	SL 5.00/21/135B 3.2SN DR BX	1630670000	G37	SL 5.08HC/09/90B 3.2SN DR BX	1154840000	G73
SL 3.50/13/180F 3.2SN DR BX	1607610000	E39	SL 5.00/04/90B 3.2SN DR BX	1580880000	G33	SL 5.00/21/180 3.2SN DR BX	1581510000	G34	SL 5.08HC/09/90F 3.2SN DR BX	1148840000	G74
SL 3.50/13/180G 3.2SN DR BX	1604580000	E39	SL 5.00/05/135 3.2SN DR BX	1630280000	G36	SL 5.00/21/180B 3.2SN DR BX	1581970000	G35	SL 5.08HC/09/90G 3.2SN DR BX	1147490000	G73
SL 3.50/13/90 3.2SN DR BX	1597320000	E36	SL 5.00/05/135B 3.2SN DR BX	1630510000	G37	SL 5.00/21/90 3.2SN DR BX	1571310000	G32	SL 5.08HC/09/90LF 3.2SN DR BX	1149610000	G75
SL 3.50/13/90F 3.2SN DR BX	1607150000	E37	SL 5.00/05/180 3.2SN DR BX	1581350000	G34	SL 5.00/21/90B 3.2SN DR BX	1581050000	G33	SL 5.08HC/09/90G 3.2SN DR BX	1146530000	G76
SL 3.50/13/90G 3.2SN DR BX	1605180000	E37	SL 5.00/05/180B 3.2SN DR BX	1581810000	G35	SL 5.00/22/135 3.2SN DR BX	1630450000	G36	SL 5.08HC/09/180 3.2SN DR BX	1147580000	G77
SL 3.50/14/135F 3.2SN DR BX	1643450000	E40	SL 5.00/05/90 3.2SN DR BX	1571160000	G32	SL 5.00/22/135B 3.2SN DR BX	1630680000	G37	SL 5.08HC/09/180F 3.2SN DR BX	1147380000	G78
SL 3.50/14/180 3.2SN DR BX	1604890000	E38	SL 5.00/05/90B 3.2SN DR BX	1580890000	G33	SL 5.00/22/180 3.2SN DR BX	1581520000	G34	SL 5.08HC/09/180G 3.2SN DR BX	1146910000	G77
SL 3.50/14/180F 3.2SN DR BX	1607620000	E39	SL 5.00/06/135 3.2SN DR BX	1630290000	G36	SL 5.00/22/180B 3.2SN DR BX	1581980000	G35	SL 5.08HC/10/180F 3.2SN DR BX	1148150000	G79
SL 3.50/14/180G 3.2SN DR BX	1604590000	E39	SL 5.00/06/135B 3.2SN DR BX	1630520000	G37	SL 5.00/22/90 3.2SN DR BX	1571320000	G32	SL 5.08HC/10/180G 3.2SN DR BX	1146900000	G72
SL 3.50/14/90 3.2SN DR BX	1597330000	E36	SL 5.00/06/180 3.2SN DR BX	1581360000	G34	SL 5.00/22/90B 3.2SN DR BX	1581060000	G33	SL 5.08HC/10/90B 3.2SN DR BX	1154850000	G73
SL 3.50/14/90F 3.2SN DR BX	1607160000	E37	SL 5.00/06/180B 3.2SN DR BX	1581820000	G35	SL 5.00/23/135 3.2SN DR BX	1630460000	G36	SL 5.08HC/10/180 3.2SN DR BX	1146880000	G72
SL 3.50/14/90G 3.2SN DR BX	1605190000	E37	SL 5.00/06/90 3.2SN DR BX	1571170000	G32	SL 5.00/23/135B 3.2SN DR BX	1630690000	G37	SL 5.08HC/10/90G 3.2SN DR BX	1147530000	G73
SL 3.50/15/135F 3.2SN DR BX	1643460000	E40	SL 5.00/06/90B 3.2SN DR BX	1580890000	G33	SL 5.00/23/180 3.2SN DR BX	1581530000	G34	SL 5.08HC/10/90LF 3.2SN DR BX	1149640000	G75
SL 3.50/15/180 3.2SN DR BX	1604900000	E38	SL 5.00/07/135 3.2SN DR BX	1630300000	G36	SL 5.00/23/180B 3.2SN DR BX	1581990000	G35	SL 5.08HC/10/90G 3.2SN DR BX	1146550000	G76
SL 3.50/15/180F 3.2SN DR BX	1607630000	E39	SL 5.00/07/135B 3.2SN DR BX	1630530000	G37	SL 5.00/23/90 3.2SN DR BX	1571330000	G32	SL 5.08HC/10/180 3.2SN DR BX	1147610000	G77
SL 3.50/15/180G 3.2SN DR BX	1604600000	E39	SL 5.00/07/180 3.2SN DR BX	1581370000	G34	SL 5.00/23/90B 3.2SN DR BX	1581070000	G33	SL 5.08HC/10/180F 3.2SN DR BX	1147410000	G78
SL 3.50/15/90 3.2SN DR BX	1597340000	E36	SL 5.00/07/180B 3.2SN DR BX	1581830000	G35	SL 5.00/24/135 3.2SN DR BX	1630470000	G36	SL 5.08HC/10/180G 3.2SN DR BX	1146930000	G77
SL 3.50/15/90F 3.2SN DR BX	1607170000	E37	SL 5.00/07/90 3.2SN DR BX	1571180000	G32	SL 5.00/24/135B 3.2SN DR BX	1630700000	G37	SL 5.08HC/10/180LF 3.2SN DR BX	1148190000	G79
SL 3.50/15/90G 3.2SN DR BX	1605200000	E37	SL 5.00/07/90B 3.2SN DR BX	1580910000	G33	SL 5.00/24/180 3.2SN DR BX	1581540000	G34	SL 5.08HC/10/90 3.2SN DR BX	1146920000	G72
SL 3.50/16/135F 3.2SN DR BX	1643470000	E40	SL 5.00/08/135 3.2SN DR BX	1630310000	G36	SL 5.00/24/180B 3.2SN DR BX	1582000000	G35	SL 5.08HC/10/90B 3.2SN DR BX	1154870000	G73
SL 3.50/16/180 3.2SN DR BX	1604910000	E38	SL 5.00/08/135B 3.2SN DR BX	1630540000	G37	SL 5.00/24/90 3.2SN DR BX	1571340000	G32	SL 5.08HC/10/90F 3.2SN DR BX	1148910000	G74
SL 3.50/16/180F 3.2SN DR BX	1607640000	E39	SL 5.00/08/180 3.2SN DR BX	1581380000	G34	SL 5.00/24/90B 3.2SN DR BX	1581080000	G33	SL 5.08HC/10/180 3.2SN DR BX	1147570000	G73
SL 3.50/16/180G 3.2SN DR BX	1604610000	E39	SL 5.00/08/180B 3.2SN DR BX	1581840000	G35	SL 5.08HC/02/180 3.2SN DR BX	1146320000	G76	SL 5.08HC/10/90G 3.2SN DR BX	1149680000	G75
SL 3.50/16/90 3.2SN DR BX	1597350000	E36	SL 5.00/08/90 3.2SN DR BX	1571190000	G32	SL 5.08HC/02/180B 3.2SN DR BX	1147300000	G77	SL 5.08HC/10/180 3.2SN DR BX	1146570000	G76
SL 3.50/16/90F 3.2SN DR BX	1607180000	E37	SL 5.00/08/90B 3.2SN DR BX	1580920000	G33	SL 5.08HC/02/180F 3.2SN DR BX	1147130000	G78	SL 5.08HC/12/180 3.2SN DR BX	1147640000	G77
SL 3.50/16/90G 3.2SN DR BX	1605210000	E37	SL 5.00/09/135 3.2SN DR BX	1630320000	G36	SL 5.08HC/02/180G 3.2SN DR BX	1146730000	G79	SL 5.08HC/12/180B 3.2SN DR BX	1147440000	G78
SL 3.50/17/135F 3.2SN DR BX	1643480000	E40	SL 5.00/09/135B 3.2SN DR BX	1630550000	G37	SL 5.08HC/02/180LF 3.2SN DR BX	1147890000	G79	SL 5.08HC/12/180G 3.2SN DR BX	1146950000	G77
SL 3.50/17/180 3.2SN DR BX	1621400000	E38	SL 5.00/09/180 3.2SN DR BX	1581390000	G34	SL 5.08HC/02/90 3.2SN DR BX	1146720000	G72	SL 5.08HC/12/180G 3.2SN DR BX	1146950000	G77
SL 3.50/17/180F 3.2SN DR BX	1622180000	E39	SL 5.00/09/180B 3.2SN DR BX	1581850000	G35	SL 5.08HC/02/90B 3.2SN DR BX	1148030000	G73	SL 5.08HC/12/180G 3.2SN DR BX	1146940000	G72
SL 3.50/17/180G 3.2SN DR BX	1621790000	E39	SL 5.00/09/90 3.2SN DR BX	1571200000	G32	SL 5.08HC/02/90F 3.2SN DR BX	1148610000	G74	SL 5.08HC/12/90B 3.2SN DR BX	1154980000	G73
SL 3.50/17/90 3.2SN DR BX	1618990000	E36	SL 5.00/09/90B 3.2SN DR BX	1580930000	G33	SL 5.08HC/02/90G 3.2SN DR BX	1147280000	G73	SL 5.08HC/12/90F 3.2SN DR BX	1148940000	G74
SL 3.50/17/90F 3.2SN DR BX	1619770000	E37	SL 5.00/10/135 3.2SN DR BX	1630330000	G36	SL 5.08HC/02/90LF 3.2SN DR BX	1149380000	G75	SL 5.08HC/12/90G 3.2SN DR BX	1147600000	G73
SL 3.50/17/90G 3.2SN DR BX	1619380000	E37	SL 5.00/10/135B 3.2SN DR BX	1630560000	G37	SL 5.08HC/03/90 3.2SN DR BX	1146340000	G76	SL 5.08HC/12/90G 3.2SN DR BX	1149710000	G75
SL 3.50/18/135F 3.2SN DR BX	1643490000	E40	SL 5.00/10/180 3.2SN DR BX	1581400000	G34	SL 5.08HC/03/180B 3.2SN DR BX	1147330000	G77	SL 5.08HC/12/90B 3.2SN DR BX	1146580000	G76
SL 3.50/18/180 3.2SN DR BX	1621410000	E38	SL 5.00/10/180B 3.2SN DR BX	1581860000	G35	SL 5.08HC/03/180G 3.2SN DR BX	1147170000	G78	SL 5.08HC/12/90B 3.2SN DR BX	1147670000	G77
SL 3.50/18/180F 3.2SN DR BX	1622190000	E39	SL 5.00/10/90 3.2SN DR BX	1571210000	G32	SL 5.08HC/03/180G 3.2SN DR BX	1146750000	G77	SL 5.08HC/12/180F 3.2SN DR BX	1147480000	G78
SL 3.50/18/180G 3.2SN DR BX	1621800000	E39	SL 5.00/10/90B 3.2SN DR BX	1580940000	G33	SL 5.08HC/03/180LF 3.2SN DR BX	1147920000	G79	SL 5.08HC/13/180G 3.2SN DR BX	1146980000	G77
SL 3.50/18/90 3.2SN DR BX	1619000000	E36	SL 5.00/11/135 3.2SN DR BX	1630340000	G36	SL 5.08HC/03/90 3.2SN DR BX	1146740000	G72	SL 5.08HC/13/180F 3.2SN DR BX	1148240000	G79
SL 3.50/18/90F 3.2SN DR BX	1619780000	E37	SL 5.00/11/135B 3.2SN DR BX	1630570000	G37	SL 5.08HC/03/90B 3.2SN DR BX	1148070000	G73	SL 5.08HC/13/90 3.2SN DR BX	1146970000	G72
SL 3.50/18/90G 3.2SN DR BX	1619390000	E37	SL 5.00/11/180 3.2SN DR BX	1581410000	G34	SL 5.08HC/03/90B 3.2SN DR BX	1148640000	G74	SL 5.08HC/13/90 3.2SN DR BX	1154980000	G73
SL 3.50/19/135F 3.2SN DR BX	1643500000	E40	SL 5.00/11/180B 3.2SN DR BX	1581870000	G35	SL 5.08HC/03/90G 3.2SN DR BX	1147310000	G77	SL 5.08HC/13/180 3.2SN DR BX	1146590000	G72
SL 3.50/19/180 3.2SN DR BX	1621420000	E38	SL 5.00/11/90 3.2SN DR BX	1571220000	G32	SL 5.08HC/03/90B 3.2SN DR BX	1147310000	G77	SL 5.08HC/13/180F 3.2SN DR BX	1147670000	G77
SL 3.50/19/180F 3.2SN DR BX	1622200000	E39	SL 5.00/11/90B 3.2SN DR BX	1580950000	G33	SL 5.08HC/03/180 3.2SN DR BX	1146380000	G76	SL 5.08HC/13/180G 3.2SN DR BX	1147480000	G78
SL 3.50/19/180G 3.2SN DR BX	1621810000	E39	SL 5.00/12/135 3.2SN DR BX	1630350000	G36	SL 5.08HC/03/180F 3.2SN DR BX	1147360000				

Type	Order No.	Page	Type	Order No.	Page	Type	Order No.	Page	Type	Order No.	Page
SL 5.08HC/17/90F 3.2SN OR BX	1149110000	G.74	SL 762HP/05/180LF 3.2 SN BK BX	1141120000	K.85	SLAT OR	1598300000	G.82	SLSMART 5.0XHC/03/180 1.5SN BK RL	1812460000	G.67
SL 5.08HC/17/90G 3.2SN OR BX	1147780000	G.73	SL 762HP/05/270G 3.2SN BK BX	1472270000	K.86	SLAT OR	1598300000	G.84	SLSMART 5.0XHC/03/90 1.5SN BK RL	1812440000	G.66
SL 5.08HC/17/90LF 3.2SN OR BX	1149880000	G.75	SL 762HP/05/270LF 3.2SN BK BX	1472390000	K.87	SLAT OR	1598300000	G.86	SLSMT 3.50/02/135F 3.2SN BK BX	1003510000	E.41
SL 5.08HC/18/180 3.2SN OR BX	1146630000	G.76	SL 762HP/05/90F 3.2 SN BK BX	1026880000	K.83	SLAT OR	1598300000	G.88	SLSMT 3.50/02/180G 1.5SN BK BX	1752984002	E.35
SL 5.08HC/18/180B 3.2SN OR BX	1147830000	G.77	SL 762HP/05/90G 3.2SN BK BX	1026790000	K.82	SLAT OR	1598300000	G.92	SLSMT 3.50/02/180G 3.2SN BK BX	1842320000	E.34
SL 5.08HC/18/180F 3.2SN OR BX	1147650000	G.78	SL 762HP/05/90LF 3.2 SN BK BX	1095950000	K.83	SLAT OR	1598300000	G.96	SLSMT 3.50/02/180LF 1.5SN BK RL	1805210000	E.35
SL 5.08HC/18/180G 3.2SN OR BX	1147090000	G.77	SL 762HP/06/180F 3.2 SN BK BX	1140910000	K.85	SLAT OR	1598300000	G.98	SLSMT 3.50/02/180LF 3.2SN BK BX	1842540000	E.35
SL 5.08HC/18/180LF 3.2SN OR BX	1148340000	G.79	SL 762HP/06/180G 3.2SN BK BX	1048990000	K.84	SLAT OR	1598300000	G.99	SLSMT 3.50/02/90F 3.2SN BK BX	1842080000	E.32
SL 5.08HC/18/90 3.2SN OR BX	1147080000	G.72	SL 762HP/06/180LF 3.2 SN BK BX	1141130000	K.85	SLAT OR	1598300000	G.100	SLSMT 3.50/02/90F 1.5SN BK RL	1761544002	E.31
SL 5.08HC/18/90B 3.2SN OR BX	1154940000	G.73	SL 762HP/06/270G 3.2SN BK BX	1472280000	K.86	SLAT OR	1598300000	G.111	SLSMT 3.50/02/90G 3.2SN BK BX	1841630000	E.30
SL 5.08HC/18/90F 3.2SN OR BX	1149140000	G.74	SL 762HP/06/270LF 3.2SN BK BX	1472410000	K.87	SLAT SW	1770240000	G.22	SLSMT 3.50/02/90G 1.5SN BK RL	1805310000	E.31
SL 5.08HC/18/90G 3.2SN OR BX	1147810000	G.73	SL 762HP/06/90F 3.2 SN BK BX	1124250000	K.83	SLAT SW	1770240000	G.24	SLSMT 3.50/02/90LF 3.2SN BK BX	1841860000	E.31
SL 5.08HC/18/90LF 3.2SN OR BX	1149910000	G.75	SL 762HP/06/90G 3.2SN BK BX	1059490000	K.82	SLAT SW	1770240000	G.26	SLSMT 3.50/02/90RF 1.5SN BK BX	1379610000	E.33
SL 5.08HC/18/180 3.2SN OR BX	1146640000	G.76	SL 762HP/06/90LF 3.2 SN BK BX	1095960000	K.83	SLAT SW	1770240000	G.28	SLSMT 3.50/03/135F 3.2SN BK BX	1003520000	E.41
SL 5.08HC/18/180B 3.2SN OR BX	1147870000	G.77	SL 762HP/07/180F 3.2 SN BK BX	1140920000	K.85	SLAT SW	1770240000	G.30	SLSMT 3.50/03/180G 1.5SN BK RL	1752994002	E.35
SL 5.08HC/18/180F 3.2SN OR BX	1147690000	G.78	SL 762HP/07/180G 3.2SN BK BX	1122590000	K.84	SLAT SW	1770240000	G.32	SLSMT 3.50/03/180G 3.2SN BK BX	1842330000	E.34
SL 5.08HC/18/180G 3.2SN OR BX	1147110000	G.77	SL 762HP/07/180LF 3.2 SN BK BX	1141140000	K.85	SLAT SW	1770240000	G.34	SLSMT 3.50/03/180LF 1.5SN BK RL	1805230000	E.35
SL 5.08HC/18/180LF 3.2SN OR BX	1148360000	G.79	SL 762HP/07/270G 3.2SN BK BX	1472290000	K.86	SLAT SW	1770240000	G.36	SLSMT 3.50/03/180LF 3.2SN BK BX	1842550000	E.35
SL 5.08HC/19/90 3.2SN OR BX	1147100000	G.72	SL 762HP/07/270LF 3.2SN BK BX	1472420000	K.87	SLAT SW	1770240000	G.38	SLSMT 3.50/03/90F 3.2SN BK BX	1842090000	E.32
SL 5.08HC/19/90B 3.2SN OR BX	1154950000	G.73	SL 762HP/07/90F 3.2 SN BK BX	1124270000	K.83	SLAT SW	1770240000	G.50	SLSMT 3.50/03/90G 1.5SN BK RL	1761554002	E.31
SL 5.08HC/19/90F 3.2SN OR BX	1149180000	G.74	SL 762HP/07/90G 3.2SN BK BX	1059500000	K.82	SLAT SW	1770240000	G.52	SLSMT 3.50/03/90G 3.2SN BK BX	1841640000	E.30
SL 5.08HC/19/90G 3.2SN OR BX	1147840000	G.73	SL 762HP/07/90LF 3.2 SN BK BX	1095970000	K.83	SLAT SW	1770240000	G.54	SLSMT 3.50/03/90LF 1.5SN BK RL	1805320000	E.31
SL 5.08HC/19/90LF 3.2SN OR BX	1149940000	G.75	SL 762HP/08/180F 3.2 SN BK BX	1140930000	K.85	SLAT SW	1770240000	G.56	SLSMT 3.50/03/90LF 3.2SN BK BX	1841870000	E.31
SL 5.08HC/20/180 3.2SN OR BX	1146650000	G.76	SL 762HP/08/180G 3.2SN BK BX	1049000000	K.84	SLAT SW	1770240000	G.58	SLSMT 3.50/03/90RF 1.5SN BK BX	1060810000	E.33
SL 5.08HC/20/180B 3.2SN OR BX	1147900000	G.77	SL 762HP/08/180LF 3.2 SN BK BX	1141150000	K.85	SLAT SW	1770240000	G.60	SLSMT 3.50/04/135F 3.2SN BK BX	1003530000	E.41
SL 5.08HC/20/180F 3.2SN OR BX	1147720000	G.78	SL 762HP/08/270G 3.2SN BK BX	1472310000	K.86	SLAT SW	1770240000	G.62	SLSMT 3.50/04/180G 1.5SN BK RL	1753004002	E.35
SL 5.08HC/20/180G 3.2SN OR BX	1147140000	G.77	SL 762HP/08/270LF 3.2SN BK BX	1472430000	K.87	SLAT SW	1770240000	G.64	SLSMT 3.50/04/180G 3.2SN BK BX	1842340000	E.34
SL 5.08HC/20/180LF 3.2SN OR BX	1148380000	G.79	SL 762HP/08/90F 3.2 SN BK BX	1124280000	K.83	SLAT SW	1770240000	G.66	SLSMT 3.50/04/180LF 1.5SN BK RL	1805240000	E.35
SL 5.08HC/20/90 3.2SN OR BX	1147120000	G.72	SL 762HP/08/90G 3.2SN BK BX	1059510000	K.82	SLAT SW	1770240000	G.68	SLSMT 3.50/04/180LF 3.2SN BK BX	1842560000	E.35
SL 5.08HC/20/90B 3.2SN OR BX	1154970000	G.73	SL 762HP/08/90LF 3.2 SN BK BX	1095980000	K.83	SLAT SW	1770240000	G.70	SLSMT 3.50/04/90F 3.2SN BK BX	1842100000	E.32
SL 5.08HC/20/90F 3.2SN OR BX	1149210000	G.74	SL 762HP/09/180F 3.2 SN BK BX	1140940000	K.85	SLAT SW	1770240000	G.72	SLSMT 3.50/04/90G 1.5SN BK RL	1761564001	E.31
SL 5.08HC/20/90G 3.2SN OR BX	1147880000	G.73	SL 762HP/09/180G 3.2SN BK BX	1122600000	K.84	SLAT SW	1770240000	G.74	SLSMT 3.50/04/90G 3.2SN BK BX	1841650000	E.30
SL 5.08HC/20/90LF 3.2SN OR BX	1149980000	G.75	SL 762HP/09/180LF 3.2 SN BK BX	1141160000	K.85	SLAT SW	1770240000	G.76	SLSMT 3.50/04/90LF 1.5SN BK RL	1805330000	E.31
SL 5.08HC/21/180 3.2SN OR BX	1146680000	G.76	SL 762HP/09/270G 3.2SN BK BX	1472320000	K.86	SLAT SW	1770240000	G.78	SLSMT 3.50/04/90LF 3.2SN BK BX	1841880000	E.31
SL 5.08HC/21/180B 3.2SN OR BX	1147930000	G.77	SL 762HP/09/270LF 3.2SN BK BX	1472440000	K.87	SLAT SW	1770240000	G.80	SLSMT 3.50/04/90RF 1.5SN BK BX	1000600000	E.33
SL 5.08HC/21/180F 3.2SN OR BX	1147750000	G.78	SL 762HP/09/90F 3.2 SN BK BX	1124290000	K.83	SLAT SW	1770240000	G.82	SLSMT 3.50/05/135F 3.2SN BK BX	1003540000	E.41
SL 5.08HC/21/180G 3.2SN OR BX	1147180000	G.77	SL 762HP/09/90G 3.2SN BK BX	1059520000	K.82	SLAT SW	1770240000	G.84	SLSMT 3.50/05/180G 1.5SN BK RL	1753014002	E.35
SL 5.08HC/21/180LF 3.2SN OR BX	1148400000	G.79	SL 762HP/09/90LF 3.2 SN BK BX	1095990000	K.83	SLAT SW	1770240000	G.86	SLSMT 3.50/05/180G 3.2SN BK BX	1842350000	E.34
SL 5.08HC/21/90 3.2SN OR BX	1147150000	G.72	SL 762HP/10/180F 3.2 SN BK BX	1140950000	K.85	SLAT SW	1770240000	G.88	SLSMT 3.50/05/180LF 1.5SN BK RL	1805250000	E.35
SL 5.08HC/21/90B 3.2SN OR BX	1154980000	G.73	SL 762HP/10/180G 3.2SN BK BX	1122610000	K.84	SLAT SW	1770240000	G.92	SLSMT 3.50/05/180LF 3.2SN BK BX	1842570000	E.35
SL 5.08HC/21/90F 3.2SN OR BX	1149240000	G.74	SL 762HP/10/180LF 3.2 SN BK BX	1141170000	K.85	SLAT SW	1770240000	G.96	SLSMT 3.50/05/90F 3.2SN BK BX	1842110000	E.32
SL 5.08HC/21/90G 3.2SN OR BX	1147910000	G.73	SL 762HP/10/270G 3.2SN BK BX	1472330000	K.86	SLAT SW	1770240000	G.98	SLSMT 3.50/05/90G 1.5SN BK RL	1761574002	E.31
SL 5.08HC/21/90LF 3.2SN OR BX	1150000000	G.75	SL 762HP/10/270LF 3.2SN BK BX	1472450000	K.87	SLAT SW	1770240000	G.99	SLSMT 3.50/05/90G 3.2SN BK BX	1841660000	E.30
SL 5.08HC/22/180 3.2SN OR BX	1146690000	G.76	SL 762HP/10/90F 3.2 SN BK BX	1124300000	K.83	SLAT SW	1770240000	G.100	SLSMT 3.50/05/90LF 1.5SN BK RL	1805340000	E.31
SL 5.08HC/22/180B 3.2SN OR BX	1147970000	G.77	SL 762HP/10/90G 3.2SN BK BX	1059530000	K.82	SLAT SW	1770240000	G.111	SLSMT 3.50/05/90LF 3.2SN BK BX	1841890000	E.31
SL 5.08HC/22/180F 3.2SN OR BX	1147790000	G.78	SL 762HP/10/90LF 3.2 SN BK BX	1096000000	K.83	SL DN 5.08/5/90F 3.5AU GR	1933160000	G.116	SLSMT 3.50/05/90RF 1.5SN BK BX	1000610000	E.33
SL 5.08HC/22/180G 3.2SN OR BX	1147210000	G.77	SL 762HP/11/180F 3.2 SN BK BX	1140960000	K.85	SL DN 5.08/5/90F 3.5AU GR	1933170000	G.116	SLSMT 3.50/05/90F 3.2SN BK BX	1003550000	E.41
SL 5.08HC/22/180LF 3.2SN OR BX	1148420000	G.79	SL 762HP/11/180G 3.2SN BK BX	1122640000	K.84	SL FLA 1.5/1	1580100000	G.22	SLSMT 3.50/06/180G 1.5SN BK RL	1753024001	E.35
SL 5.08HC/22/90 3.2SN OR BX	1147190000	G.72	SL 762HP/11/180LF 3.2 SN BK BX	1141180000	K.85	SL FLA 1.5/1	1580100000	G.24	SLSMT 3.50/06/180G 3.2SN BK BX	1842360000	E.34
SL 5.08HC/22/90B 3.2SN OR BX	1154990000	G.73	SL 762HP/11/270G 3.2SN BK BX	1472340000	K.86	SL FLA 1.5/1	1580100000	G.32	SLSMT 3.50/06/180LF 1.5SN BK RL	1805270000	E.35
SL 5.08HC/22/90F 3.2SN OR BX	1149280000	G.74	SL 762HP/11/270LF 3.2SN BK BX	1472460000	K.87	SL FLA 1.5/1	1580100000	G.50	SLSMT 3.50/06/180LF 3.2SN BK BX	1842580000	E.35
SL 5.08HC/22/90G 3.2SN OR BX	1147940000	G.73	SL 762HP/11/90F 3.2 SN BK BX	1124310000	K.83	SL FLA 1.5/1	1580100000	G.52	SLSMT 3.50/06/135F 3.2SN BK BX	1842120000	E.32
SL 5.08HC/22/90LF 3.2SN OR BX	1150020000	G.75	SL 762HP/11/90G 3.2SN BK BX	1059550000	K.82	SL FLA 1.5/1	1580100000	G.54	SLSMT 3.50/06/90G 1.5SN BK RL	1761584001	E.31
SL 5.08HC/23/180 3.2SN OR BX	1146700000	G.76	SL 762HP/11/90LF 3.2 SN BK BX	1096010000	K.83	SL FLA 1.5/1	1580100000	G.66	SLSMT 3.50/06/90G 3.2SN BK BX	1841670000	E.30
SL 5.08HC/23/180B 3.2SN OR BX	1148010000	G.77	SL 762HP/12/180F 3.2 SN BK BX	1140970000	K.85	SL FLA 1.5/1	1580100000	G.72	SLSMT 3.50/06/90LF 1.5SN BK RL	1805350000	E.31
SL 5.08HC/23/180F 3.2SN OR BX	1147820000	G.78	SL 762HP/12/180G 3.2SN BK BX	1122650000	K.84	SL FLA 1.5/1	1580100000	G.74	SLSMT 3.50/06/90LF 3.2SN BK BX	1841900000	E.31
SL 5.08HC/23/180G 3.2SN OR BX	1147240000	G.77	SL 762HP/12/180LF 3.2 SN BK BX	1141190000	K.85	SL FLA 1.5/1	1580100000	G.19	SLSMT 3.50/06/90F 1.5SN BK RL	1000620000	E.33
SL 5.08HC/23/180LF 3.2SN OR BX	1148440000	G.79	SL 762HP/12/270G 3.2SN BK BX	1472350000	K.86	SL FLA 2.3/1	1636670000	G.22	SLSMT 3.50/07/135F 3.2SN BK BX	1003560000	E.41
SL 5.08HC/23/90 3.2SN OR BX	1147210000	G.72	SL 762HP/12/270LF 3.2SN BK BX	1472470000	K.87	SL FLA 2.3/1	1636670000	G.24	SLSMT 3.50/07/180G 1.5SN BK RL	1753034001	E.35
SL 5.08HC/23/90B 3.2SN OR BX	1155010000	G.73	SL 762HP/12/270LF 3.2SN BK BX	1472470000	K.87	SL FLA 2.3/1	1636670000	G.32	SLSMT 3.50/07/180G 3.2SN BK BX	1842370000	E.34
SL 5.08HC/23/90F 3.2SN OR BX	1149310000	G.74	SL 762HP/12/90F 3.2 SN BK BX	1124320000	K.83	SL FLA 2.3/1	1636670000	G.50	SLSMT 3.50/07/180LF 1.5SN BK RL	1805280000	E.35
SL 5.08HC/23/90G 3.2SN OR BX	1147980000	G.73	SL 762HP/12/90G 3.2SN BK BX	1059570000	K.82	SL FLA 2.3/1	1636670000	G.52	SLSMT 3.50/07/180LF 3.2SN BK BX	1842590000	E.35
SL 5.08HC/23/90LF 3.2SN OR BX	1150040000	G.75	SL 762HP/12/90LF 3.2 SN BK BX	1096020000	K.83	SL FLA 2.3/1	1636670000	G.54	SLSMT 3.50/07/90F 3.2SN BK BX	1842130000	E.32
SL 5.08HC/24/180 3.2SN OR BX	1146710000	G.76	SL 762IT/02/90M2F 3.2SN BK BX SO	1173610000	K.52	SL FLA 2.3/1	1636670000	G.66	SLSMT 3.50/07/90F 1.5SN BK RL	1761594001	E.31
SL 5.08HC/24/180B 3.2SN OR BX	1148040000	G.77	SL 762IT/03/90M2F 3.2SN BK BX	1173640000	K.52	SL FLA 2.3/1	1636670000	G.66	SLSMT 3.50/07/90G 3.2SN BK BX	1842120000	E.32
SL 5.08HC/24/180F 3.2SN OR BX	1147850000	G.78	SL 762IT/03/90M3F 3.2SN BK BX	1173690000							

Type	Order No.	Page	Type	Order No.	Page	Type	Order No.	Page	Type	Order No.	Page
SL-SMT 3.50/10/90LF 3.2SN BK BX	1841940000	E.31	SL-SMT 5.00HC/02/180LF 3.2SN BK BX	1841390000	G.28	SL-SMT 5.00HC/13/180G 3.2SN BK BX	1841270000	G.27	SL-SMT 5.08HC/03/180LF 3.2SN BK BX	1838450000	G.60
SL-SMT 3.50/10/90RF 1.5SN BK BX	1060780000	E.33	SL-SMT 5.00HC/02/90 1.5SN BK RL	1797620000	G.23	SL-SMT 5.00HC/13/180LF 3.2SN BK BX	1841500000	G.28	SL-SMT 5.08HC/03/270FH 1.5SN BK RL	1876930000	G.65
SL-SMT 3.50/11/135F 3.2SN BK BX	1003600000	E.41	SL-SMT 5.00HC/02/90 3.2SN BK BX	1839890000	G.23	SL-SMT 5.00HC/13/90G 3.2SN BK BX	1840000000	G.22	SL-SMT 5.08HC/03/270LF 3.2SN BK BX	1877210000	G.65
SL-SMT 3.50/11/180G 1.5SN BK RL	1753074001	E.35	SL-SMT 5.00HC/02/90G 1.5SN BK RL	1797690000	G.23	SL-SMT 5.00HC/13/90G 3.2SN BK BX	1840230000	G.22	SL-SMT 5.08HC/03/270LF 1.5SN BK RL	1877000000	G.65
SL-SMT 3.50/11/180G 3.2SN BK BX	1842400000	E.34	SL-SMT 5.00HC/02/90G 3.2SN BK BX	1840120000	G.23	SL-SMT 5.00HC/14/180G 3.2SN BK BX	1840460000	G.24	SL-SMT 5.08HC/03/270LF 3.2SN BK BX	1876860000	G.64
SL-SMT 3.50/11/180LF 3.2SN BK BX	1842630000	E.35	SL-SMT 5.00HC/02/90LF 1.5SN BK RL	1797750000	G.25	SL-SMT 5.00HC/14/180G 3.2SN BK BX	1841050000	G.26	SL-SMT 5.08HC/03/270GH 1.5SN BK RL	1877600000	G.63
SL-SMT 3.50/11/90F 3.2SN BK BX	1842170000	E.32	SL-SMT 5.00HC/02/90LF 3.2SN BK BX	1840350000	G.24	SL-SMT 5.00HC/14/180G 3.2SN BK BX	1841280000	G.27	SL-SMT 5.08HC/03/270GH 3.2SN BK BX	1877380000	G.63
SL-SMT 3.50/11/90G 1.5SN BK RL	1761634001	E.31	SL-SMT 5.00HC/03/180 1.5SN BK RL	1797810000	G.27	SL-SMT 5.00HC/14/180LF 3.2SN BK BX	1841510000	G.28	SL-SMT 5.08HC/03/270GL 1.5SN BK RL	1877500000	G.62
SL-SMT 3.50/11/90G 3.2SN BK BX	1841720000	E.30	SL-SMT 5.00HC/03/180 3.2SN BK BX	1840930000	G.26	SL-SMT 5.00HC/14/90G 3.2SN BK BX	1840010000	G.22	SL-SMT 5.08HC/03/270GL 3.2SN BK BX	1877490000	G.63
SL-SMT 3.50/11/90LF 3.2SN BK BX	1841950000	E.31	SL-SMT 5.00HC/03/180G 1.5SN BK RL	1797880000	G.27	SL-SMT 5.00HC/14/90G 3.2SN BK BX	1840240000	G.23	SL-SMT 5.08HC/03/90 1.5SN BK RL	1821170000	G.51
SL-SMT 3.50/11/90RF 1.5SN BK BX	1000660000	E.33	SL-SMT 5.00HC/03/180G 3.2SN BK BX	1841170000	G.27	SL-SMT 5.00HC/15/180 3.2SN BK BX	1840470000	G.24	SL-SMT 5.08HC/03/90 3.2SN BK BX	1779960000	G.50
SL-SMT 3.50/12/135F 3.2SN BK BX	1003620000	E.41	SL-SMT 5.00HC/03/180LF 1.5SN BK RL	1797940000	G.28	SL-SMT 5.00HC/15/180 3.2SN BK BX	1841060000	G.26	SL-SMT 5.08HC/03/90F 3.2SN BK BX	1837640000	G.52
SL-SMT 3.50/12/180G 3.2SN BK BX	1842410000	E.34	SL-SMT 5.00HC/03/180LF 3.2SN BK BX	1841400000	G.29	SL-SMT 5.00HC/15/180G 3.2SN BK BX	1841290000	G.27	SL-SMT 5.08HC/03/90G 1.5SN BK RL	1775014001	G.51
SL-SMT 3.50/12/180LF 3.2SN BK BX	1842640000	E.35	SL-SMT 5.00HC/03/90 1.5SN BK RL	1797630000	G.23	SL-SMT 5.00HC/15/180LF 3.2SN BK BX	1841520000	G.28	SL-SMT 5.08HC/03/90G 3.2SN BK BX	18780190000	G.51
SL-SMT 3.50/12/90F 3.2SN BK BX	1842180000	E.32	SL-SMT 5.00HC/03/90 3.2SN BK BX	1839900000	G.22	SL-SMT 5.00HC/15/90G 3.2SN BK BX	1840020000	G.22	SL-SMT 5.08HC/03/90LF 1.5SN BK RL	1775244001	G.55
SL-SMT 3.50/12/90G 3.2SN BK BX	1841730000	E.30	SL-SMT 5.00HC/03/90G 1.5SN BK RL	1797700000	G.23	SL-SMT 5.00HC/15/90G 3.2SN BK BX	1840250000	G.23	SL-SMT 5.08HC/03/90LF 3.2SN BK BX	1780420000	G.54
SL-SMT 3.50/12/90LF 3.2SN BK BX	1840340000	E.33	SL-SMT 5.00HC/03/90G 3.2SN BK BX	1840130000	G.23	SL-SMT 5.00HC/15/90G 3.2SN BK BX	1840480000	G.24	SL-SMT 5.08HC/04/180 1.5SN BK RL	1775594001	G.57
SL-SMT 3.50/12/90RF 1.5SN BK BX	1000670000	E.31	SL-SMT 5.00HC/03/90LF 1.5SN BK RL	1797760000	G.25	SL-SMT 5.00HC/16/180 3.2SN BK BX	1841070000	G.26	SL-SMT 5.08HC/04/180 3.2SN BK BX	1838000000	G.56
SL-SMT 3.50/13/135F 3.2SN BK BX	1003630000	E.41	SL-SMT 5.00HC/03/90LF 3.2SN BK BX	1840360000	G.24	SL-SMT 5.00HC/16/180G 3.2SN BK BX	1841300000	G.27	SL-SMT 5.08HC/04/180F 3.2SN BK BX	1837870000	G.58
SL-SMT 3.50/13/180G 3.2SN BK BX	1842420000	E.34	SL-SMT 5.00HC/04/180 1.5SN BK RL	1797820000	G.27	SL-SMT 5.00HC/16/180LF 3.2SN BK BX	1841530000	G.28	SL-SMT 5.08HC/04/180G 1.5SN BK RL	1775944001	G.57
SL-SMT 3.50/13/180LF 3.2SN BK BX	1842650000	E.35	SL-SMT 5.00HC/04/180 3.2SN BK BX	1840940000	G.26	SL-SMT 5.00HC/16/90 3.2SN BK BX	1840030000	G.22	SL-SMT 5.08HC/04/180F 3.2SN BK BX	1838230000	G.57
SL-SMT 3.50/13/90F 3.2SN BK BX	1842190000	E.32	SL-SMT 5.00HC/04/180G 1.5SN BK RL	1797890000	G.27	SL-SMT 5.00HC/16/90G 3.2SN BK BX	1840260000	G.23	SL-SMT 5.08HC/04/180LF 1.5SN BK RL	1776384001	G.61
SL-SMT 3.50/13/90G 3.2SN BK BX	1841740000	E.30	SL-SMT 5.00HC/04/180G 3.2SN BK BX	1841180000	G.27	SL-SMT 5.00HC/16/90LF 3.2SN BK BX	1840490000	G.24	SL-SMT 5.08HC/04/180LF 3.2SN BK BX	1838460000	G.60
SL-SMT 3.50/13/90LF 3.2SN BK BX	1841960000	E.31	SL-SMT 5.00HC/04/180LF 1.5SN BK RL	1797950000	G.28	SL-SMT 5.00HC/17/180 3.2SN BK BX	1841080000	G.26	SL-SMT 5.08HC/04/270FH 1.5SN BK RL	1876940000	G.65
SL-SMT 3.50/13/90RF 1.5SN BK BX	1000680000	E.33	SL-SMT 5.00HC/04/180LF 3.2SN BK BX	1841410000	G.29	SL-SMT 5.00HC/17/180G 3.2SN BK BX	1841310000	G.27	SL-SMT 5.08HC/04/270FH 3.2SN BK BX	1877330000	G.65
SL-SMT 3.50/14/135F 3.2SN BK BX	1003640000	E.41	SL-SMT 5.00HC/04/90 1.5SN BK RL	1797640000	G.23	SL-SMT 5.00HC/17/180LF 3.2SN BK BX	1841540000	G.28	SL-SMT 5.08HC/04/270FL 1.5SN BK RL	1877020000	G.65
SL-SMT 3.50/14/180G 3.2SN BK BX	1842430000	E.34	SL-SMT 5.00HC/04/90 3.2SN BK BX	1839910000	G.22	SL-SMT 5.00HC/17/90 3.2SN BK BX	1840040000	G.22	SL-SMT 5.08HC/04/270FL 3.2SN BK BX	1876870000	G.64
SL-SMT 3.50/14/180LF 3.2SN BK BX	1842660000	E.35	SL-SMT 5.00HC/04/90G 1.5SN BK RL	1797710000	G.23	SL-SMT 5.00HC/17/90G 3.2SN BK BX	1840270000	G.23	SL-SMT 5.08HC/04/270GH 1.5SN BK RL	1877610000	G.63
SL-SMT 3.50/14/90F 3.2SN BK BX	1842200000	E.32	SL-SMT 5.00HC/04/90G 3.2SN BK BX	1840140000	G.23	SL-SMT 5.00HC/17/90LF 3.2SN BK BX	1840500000	G.24	SL-SMT 5.08HC/04/270GH 3.2SN BK BX	1877390000	G.63
SL-SMT 3.50/14/90G 3.2SN BK BX	1841750000	E.30	SL-SMT 5.00HC/04/90LF 1.5SN BK RL	1797770000	G.25	SL-SMT 5.00HC/18/180 3.2SN BK BX	1841090000	G.26	SL-SMT 5.08HC/04/270GL 1.5SN BK RL	1877760000	G.63
SL-SMT 3.50/14/90LF 3.2SN BK BX	1841970000	E.31	SL-SMT 5.00HC/04/90LF 3.2SN BK BX	1840370000	G.24	SL-SMT 5.00HC/18/180G 3.2SN BK BX	1841320000	G.27	SL-SMT 5.08HC/04/270GL 3.2SN BK BX	1877510000	G.62
SL-SMT 3.50/14/90RF 1.5SN BK BX	1000690000	E.33	SL-SMT 5.00HC/05/180 1.5SN BK RL	1797830000	G.27	SL-SMT 5.00HC/18/180LF 3.2SN BK BX	1841550000	G.28	SL-SMT 5.08HC/04/270FL 3.2SN BK BX	1774784001	G.51
SL-SMT 3.50/15/135F 3.2SN BK BX	1003650000	E.41	SL-SMT 5.00HC/05/180 3.2SN BK BX	1840950000	G.26	SL-SMT 5.00HC/18/90 3.2SN BK BX	1840050000	G.22	SL-SMT 5.08HC/04/90 3.2SN BK BX	1779970000	G.50
SL-SMT 3.50/15/180G 3.2SN BK BX	1842440000	E.34	SL-SMT 5.00HC/05/180G 1.5SN BK RL	1797900000	G.27	SL-SMT 5.00HC/18/90G 3.2SN BK BX	1840280000	G.23	SL-SMT 5.08HC/04/90F 3.2SN BK BX	1837650000	G.52
SL-SMT 3.50/15/180LF 3.2SN BK BX	1842670000	E.35	SL-SMT 5.00HC/05/180G 3.2SN BK BX	1841190000	G.27	SL-SMT 5.00HC/18/90LF 3.2SN BK BX	1840510000	G.24	SL-SMT 5.08HC/04/90G 1.5SN BK RL	1775024001	G.51
SL-SMT 3.50/15/90F 3.2SN BK BX	1842210000	E.32	SL-SMT 5.00HC/05/180LF 1.5SN BK RL	1797960000	G.28	SL-SMT 5.00HC/19/180 3.2SN BK BX	1841100000	G.26	SL-SMT 5.08HC/04/90G 3.2SN BK BX	1780200000	G.51
SL-SMT 3.50/15/90G 3.2SN BK BX	1841760000	E.30	SL-SMT 5.00HC/05/180LF 3.2SN BK BX	1841420000	G.29	SL-SMT 5.00HC/19/180G 3.2SN BK BX	1841330000	G.27	SL-SMT 5.08HC/04/90LF 1.5SN BK RL	1775254001	G.55
SL-SMT 3.50/15/90LF 3.2SN BK BX	1841980000	E.31	SL-SMT 5.00HC/05/90 1.5SN BK RL	1797650000	G.23	SL-SMT 5.00HC/19/180LF 3.2SN BK BX	1841560000	G.28	SL-SMT 5.08HC/04/90LF 3.2SN BK BX	1780430000	G.54
SL-SMT 3.50/15/90RF 1.5SN BK BX	1000700000	E.33	SL-SMT 5.00HC/05/90 3.2SN BK BX	1839920000	G.22	SL-SMT 5.00HC/19/90 3.2SN BK BX	1840060000	G.22	SL-SMT 5.08HC/05/180 1.5SN BK RL	1775634001	G.57
SL-SMT 3.50/16/135F 3.2SN BK BX	1003660000	E.41	SL-SMT 5.00HC/05/90G 1.5SN BK RL	1797720000	G.23	SL-SMT 5.00HC/19/90G 3.2SN BK BX	1840290000	G.23	SL-SMT 5.08HC/05/180 3.2SN BK BX	1838010000	G.56
SL-SMT 3.50/16/180G 3.2SN BK BX	1842450000	E.34	SL-SMT 5.00HC/05/90G 3.2SN BK BX	1840150000	G.23	SL-SMT 5.00HC/19/90LF 3.2SN BK BX	1840520000	G.24	SL-SMT 5.08HC/05/180F 3.2SN BK BX	1820770000	G.58
SL-SMT 3.50/16/180LF 3.2SN BK BX	1842680000	E.35	SL-SMT 5.00HC/05/90LF 1.5SN BK RL	1797780000	G.25	SL-SMT 5.00HC/20/180 3.2SN BK BX	1841110000	G.26	SL-SMT 5.08HC/05/180G 1.5SN BK RL	1775954001	G.57
SL-SMT 3.50/16/90F 3.2SN BK BX	1842220000	E.32	SL-SMT 5.00HC/05/90LF 3.2SN BK BX	1840380000	G.24	SL-SMT 5.00HC/20/180G 3.2SN BK BX	1841340000	G.27	SL-SMT 5.08HC/05/180G 3.2SN BK BX	1838240000	G.57
SL-SMT 3.50/16/90G 3.2SN BK BX	1841770000	E.30	SL-SMT 5.00HC/06/180 1.5SN BK RL	1797840000	G.27	SL-SMT 5.00HC/20/180LF 3.2SN BK BX	1841570000	G.28	SL-SMT 5.08HC/05/180LF 1.5SN BK RL	1776394001	G.61
SL-SMT 3.50/16/90LF 3.2SN BK BX	1841990000	E.31	SL-SMT 5.00HC/06/180 3.2SN BK BX	1840960000	G.26	SL-SMT 5.00HC/20/90 3.2SN BK BX	1840070000	G.22	SL-SMT 5.08HC/05/180LF 3.2SN BK BX	1838470000	G.60
SL-SMT 3.50/16/90RF 1.5SN BK BX	1060820000	E.33	SL-SMT 5.00HC/06/180G 1.5SN BK RL	1797910000	G.27	SL-SMT 5.00HC/20/90G 3.2SN BK BX	1840300000	G.23	SL-SMT 5.08HC/05/270FH 1.5SN BK RL	1876950000	G.65
SL-SMT 3.50/17/135F 3.2SN BK BX	1003670000	E.41	SL-SMT 5.00HC/06/180G 3.2SN BK BX	1841200000	G.27	SL-SMT 5.00HC/20/90G 3.2SN BK BX	1840530000	G.24	SL-SMT 5.08HC/05/270FH 3.2SN BK BX	1877430000	G.65
SL-SMT 3.50/17/180G 3.2SN BK BX	1842460000	E.34	SL-SMT 5.00HC/06/180LF 1.5SN BK RL	1797970000	G.28	SL-SMT 5.00HC/21/180 3.2SN BK BX	1841120000	G.26	SL-SMT 5.08HC/05/270FL 1.5SN BK RL	1877070000	G.65
SL-SMT 3.50/17/180LF 3.2SN BK BX	1842690000	E.35	SL-SMT 5.00HC/06/180LF 3.2SN BK BX	1841430000	G.29	SL-SMT 5.00HC/21/180G 3.2SN BK BX	1841350000	G.27	SL-SMT 5.08HC/05/270FL 3.2SN BK BX	1876880000	G.64
SL-SMT 3.50/17/90F 3.2SN BK BX	1842230000	E.32	SL-SMT 5.00HC/06/90 1.5SN BK RL	1797660000	G.23	SL-SMT 5.00HC/21/180LF 3.2SN BK BX	1841580000	G.28	SL-SMT 5.08HC/05/270GH 1.5SN BK RL	1877620000	G.63
SL-SMT 3.50/17/90G 3.2SN BK BX	1841780000	E.30	SL-SMT 5.00HC/06/90 3.2SN BK BX	1839930000	G.22	SL-SMT 5.00HC/21/90 3.2SN BK BX	1840080000	G.22	SL-SMT 5.08HC/05/270GH 3.2SN BK BX	1877400000	G.63
SL-SMT 3.50/17/90LF 3.2SN BK BX	1842000000	E.31	SL-SMT 5.00HC/06/90G 1.5SN BK RL	1797730000	G.23	SL-SMT 5.00HC/21/90G 3.2SN BK BX	1840310000	G.23	SL-SMT 5.08HC/05/270GL 1.5SN BK RL	1877700000	G.63
SL-SMT 3.50/18/135F 3.2SN BK BX	1003680000	E.41	SL-SMT 5.00HC/06/90G 3.2SN BK BX	1840160000	G.23	SL-SMT 5.00HC/21/90LF 3.2SN BK BX	1840540000	G.24	SL-SMT 5.08HC/05/270GL 3.2SN BK BX	1877520000	G.62
SL-SMT 3.50/18/180G 3.2SN BK BX	1842470000	E.34	SL-SMT 5.00HC/06/90LF 1.5SN BK RL	1797790000	G.25	SL-SMT 5.00HC/22/180 3.2SN BK BX	1841130000	G.26	SL-SMT 5.08HC/05/90 1.5SN BK RL	1774794001	G.51
SL-SMT 3.50/18/180LF 3.2SN BK BX	1842700000	E.35	SL-SMT 5.00HC/06/90LF 3.2SN BK BX	1840390000	G.24	SL-SMT 5.00HC/22/180G 3.2SN BK BX	1841360000	G.27	SL-SMT 5.08HC/05/90 3.2SN BK BX	1779980000	G.50
SL-SMT 3.50/18/90F 3.2SN BK BX	1842240000	E.32	SL-SMT 5.00HC/07/180 1.5SN BK RL	1797850000	G.27	SL-SMT 5.00HC/22/180LF 3.2SN BK BX	1841590000	G.28	SL-SMT 5.08HC/05/90F 3.2SN BK BX	1837660000	G.52
SL-SMT 3.50/18/90G 3.2SN BK BX	1841790000	E.30	SL-SMT 5.00HC/07/180 3.2SN BK BX	1840970000	G.26	SL-SMT 5.00HC/22/90 3.2SN BK BX	1840090000	G.22	SL-SMT 5.08HC/05/90G 1.5SN BK RL	1775034001	G.51
SL-SMT 3.50/18/90LF 3.2SN BK BX	1842010000	E.31	SL-SMT 5.00HC/07/180G 1.5SN BK RL	1797920000	G.27	SL-SMT 5.00HC/22/90G 3.2SN BK BX	1840320000	G.23	SL-SMT 5.08HC/05/90G 3.2SN BK BX	1780210000	G.51
SL-SMT 3.50/19/135F 3.2SN BK BX	1003690000	E.41	SL-SMT 5.00HC/07/180G 3.2SN BK BX</								



Type	Order No.	Page	Type	Order No.	Page	Type	Order No.	Page	Type	Order No.	Page
SLD 5.08/40/180G 3.2SN OR BX	1602570000	G.83	SLDV-THR 5.00/16/180G 3.2SN BK BX	1862380000	G.30	SLDV-THR 5.08/36/180FLF 3.2SN BK BX	1889270000	G.69	SL5 5.08/05/180F SN OR BX	1846390000	G.97
SLD 5.08/40/90G 3.2SN OR BX	1601970000	G.82	SLDV-THR 5.00/16/180GFLF 3.2SN BK BX	1911360000	G.31	SLDV-THR 5.08/38/180F 3.2SN BK BX	1889380000	G.68	SL5 5.08/05/180F SN OR BX	1846240000	G.97
SLD 5.08/42/180G 3.2SN OR BX	1602580000	G.83	SLDV-THR 5.00/18/180F 3.2SN BK BX	1883000000	G.31	SLDV-THR 5.08/38/180FLF 3.2SN BK BX	1889280000	G.69	SL5 5.08/06/180 SN OR BX	1627130000	G.96
SLD 5.08/42/90G 3.2SN OR BX	1601980000	G.82	SLDV-THR 5.00/18/180FLF 3.2SN BK BX	1883170000	G.31	SLDV-THR 5.08/40/180F 3.2SN BK BX	1889390000	G.68	SL5 5.08/06/180B SN OR BX	1627280000	G.97
SLD 5.08/44/180G 3.2SN OR BX	1602590000	G.83	SLDV-THR 5.00/18/180G 3.2SN BK BX	1882740000	G.30	SLDV-THR 5.08/40/180FLF 3.2SN BK BX	1889290000	G.69	SL5 5.08/06/180F SN OR BX	1355250000	G.86
SLD 5.08/44/90G 3.2SN OR BX	1601990000	G.82	SLDV-THR 5.00/18/180GFLF 3.2SN BK BX	1911370000	G.31	SLDV-THR 5.08/42/180F 3.2SN BK BX	1889400000	G.68	SL5 5.08/06/180F SN OR BX	1846400000	G.97
SLD 5.08/46/180G 3.2SN OR BX	1602600000	G.83	SLDV-THR 5.00/20/180F 3.2SN BK BX	1881340000	G.31	SLDV-THR 5.08/42/180FLF 3.2SN BK BX	1889300000	G.69	SL5 5.08/06/180B SN OR BX	1846250000	G.97
SLD 5.08/46/90G 3.2SN OR BX	1602000000	G.82	SLDV-THR 5.00/20/180GFLF 3.2SN BK BX	1883180000	G.31	SLDV-THR 5.08/44/180F 3.2SN BK BX	1889410000	G.68	SL5 5.08/06/180TB KF SN OR BX	1846140000	G.99
SLD 5.08/48/180G 3.2SN OR BX	1602610000	G.83	SLDV-THR 5.00/20/180G 3.2SN BK BX	1882390000	G.30	SLDV-THR 5.08/44/180FLF 3.2SN BK BX	1889310000	G.69	SL5 5.08/07/180 SN OR BX	1846600000	G.98
SLD 5.08/48/90G 3.2SN OR BX	1602010000	G.82	SLDV-THR 5.00/22/180GFLF 3.2SN BK BX	1911410000	G.31	SLDV-THR 5.08/46/180F 3.2SN BK BX	1889420000	G.68	SL5 5.08/07/180B SN OR BX	1627140000	G.96
SLD 5.08/04/180 3.2SN OR BX	1725650000	G.81	SLDV-THR 5.00/22/180F 3.2SN BK BX	1883010000	G.31	SLDV-THR 5.08/46/180FLF 3.2SN BK BX	1889320000	G.69	SL5 5.08/07/180B SN OR BX	1627290000	G.97
SLD 5.08/04/90 3.2SN OR BX	1725170000	G.80	SLDV-THR 5.00/22/180FLF 3.2SN BK BX	1883190000	G.31	SLDV-THR 5.08/48/180F 3.2SN BK BX	1889430000	G.68	SL5 5.08/07/180F SN OR BX	1353530000	G.86
SLD 5.08/06/180 3.2SN OR BX	1725660000	G.81	SLDV-THR 5.00/22/180G 3.2SN BK BX	1882750000	G.30	SLDV-THR 5.08/48/180FLF 3.2SN BK BX	1889330000	G.69	SL5 5.08/07/180F SN OR BX	1846410000	G.97
SLD 5.08/06/90 3.2SN OR BX	1725180000	G.80	SLDV-THR 5.00/22/180GFLF 3.2SN BK BX	1911470000	G.31	SLF 5.08/02/180 SN OR BX	1335330000	G.102	SL5 5.08/07/180B SN OR BX	1846260000	G.97
SLD 5.08/08/180 3.2SN OR BX	1725670000	G.81	SLDV-THR 5.00/24/180F 3.2SN BK BX	1881370000	G.31	SLF 5.08/02/180B SN OR BX	1335440000	G.103	SL5 5.08/08/180 SN OR BX	1627150000	G.96
SLD 5.08/08/90 3.2SN OR BX	1725190000	G.80	SLDV-THR 5.00/24/180GFLF 3.2SN BK BX	1883200000	G.31	SLF 5.08/02/180B SN OR BX	1335580000	G.103	SL5 5.08/08/180B SN OR BX	1627300000	G.97
SLD 5.08/10/180 3.2SN OR BX	1725680000	G.81	SLDV-THR 5.00/24/180G 3.2SN BK BX	1882760000	G.30	SLF 5.08/02/180F SN OR BX	1335590000	G.103	SL5 5.08/08/180F SN OR BX	1355540000	G.86
SLD 5.08/10/90 3.2SN OR BX	1725200000	G.80	SLDV-THR 5.00/24/180GFLF 3.2SN BK BX	1911500000	G.31	SLF 5.08/02/180F SN OR BX	1336400000	G.103	SL5 5.08/08/180F SN OR BX	1846420000	G.97
SLD 5.08/12/180 3.2SN OR BX	1725690000	G.81	SLDV-THR 5.00/26/180F 3.2SN BK BX	1883020000	G.31	SLF 5.08/03/180 SN OR BX	1335340000	G.102	SL5 5.08/08/180F SN OR BX	1846270000	G.97
SLD 5.08/12/90 3.2SN OR BX	1725210000	G.80	SLDV-THR 5.00/26/180FLF 3.2SN BK BX	1883230000	G.31	SLF 5.08/03/180B SN OR BX	1335450000	G.103	SL5 5.08/08/180TB KF SN OR BX	1846150000	G.99
SLD 5.08/16/180 3.2SN OR BX	1725700000	G.81	SLDV-THR 5.00/26/180G 3.2SN BK BX	1882770000	G.30	SLF 5.08/03/180B SN OR BX	1335350000	G.103	SL5 5.08/08/180TB KF SN OR BX	1846070000	G.98
SLD 5.08/16/90 3.2SN OR BX	1725220000	G.80	SLDV-THR 5.00/28/180F 3.2SN BK BX	1911520000	G.31	SLF 5.08/03/180F SN OR BX	1335620000	G.103	SL5 5.08/09/180 SN OR BX	1627160000	G.96
SLD 5.08/18/180 3.2SN OR BX	1725710000	G.81	SLDV-THR 5.00/28/180FLF 3.2SN BK BX	1881390000	G.31	SLF 5.08/03/180F SN OR BX	1336410000	G.103	SL5 5.08/09/180B SN OR BX	1627310000	G.97
SLD 5.08/18/90 3.2SN OR BX	1725230000	G.80	SLDV-THR 5.00/28/180FLF 3.2SN BK BX	1883240000	G.31	SLF 5.08/04/180 SN OR BX	1335350000	G.102	SL5 5.08/09/180F SN OR BX	1353550000	G.86
SLD 5.08/18/180 3.2SN OR BX	1725720000	G.81	SLDV-THR 5.00/28/180G 3.2SN BK BX	1882780000	G.30	SLF 5.08/04/180B SN OR BX	1335460000	G.103	SL5 5.08/09/180F SN OR BX	1846430000	G.97
SLD 5.08/18/90 3.2SN OR BX	1725240000	G.80	SLDV-THR 5.00/28/180GFLF 3.2SN BK BX	1911550000	G.31	SLF 5.08/04/180B SN OR BX	1335600000	G.103	SL5 5.08/09/180B SN OR BX	1846280000	G.97
SLD 5.08/20/180 3.2SN OR BX	1725730000	G.81	SLDV-THR 5.00/30/180F 3.2SN BK BX	1883030000	G.31	SLF 5.08/04/180F SN OR BX	1336420000	G.103	SL5 5.08/10/180 SN OR BX	1627170000	G.96
SLD 5.08/20/90 3.2SN OR BX	1725250000	G.80	SLDV-THR 5.00/30/180FLF 3.2SN BK BX	1883250000	G.31	SLF 5.08/04/180F SN OR BX	1336430000	G.103	SL5 5.08/10/180B SN OR BX	1627320000	G.97
SLD 5.08/22/180 3.2SN OR BX	1725740000	G.81	SLDV-THR 5.00/30/180G 3.2SN BK BX	1882790000	G.30	SLF 5.08/05/180 SN OR BX	1335360000	G.102	SL5 5.08/10/180B SN OR BX	1353560000	G.86
SLD 5.08/22/90 3.2SN OR BX	1725260000	G.80	SLDV-THR 5.00/30/180GFLF 3.2SN BK BX	1911640000	G.31	SLF 5.08/05/180B SN OR BX	1335470000	G.103	SL5 5.08/10/180F SN OR BX	1846440000	G.97
SLD 5.08/24/180 3.2SN OR BX	1725750000	G.81	SLDV-THR 5.00/32/180F 3.2SN BK BX	1881400000	G.31	SLF 5.08/05/180F SN OR BX	1335370000	G.103	SL5 5.08/10/180F SN OR BX	1846290000	G.97
SLD 5.08/24/90 3.2SN OR BX	1725270000	G.80	SLDV-THR 5.00/32/180FLF 3.2SN BK BX	1883270000	G.31	SLF 5.08/05/180F SN OR BX	1335600000	G.103	SL5 5.08/10/180TB KF SN OR BX	1846160000	G.99
SLD 5.08/26/180 3.2SN OR BX	1725760000	G.81	SLDV-THR 5.00/32/180G 3.2SN BK BX	1882800000	G.30	SLF 5.08/05/180F SN OR BX	1336430000	G.103	SL5 5.08/10/180TB KF SN OR BX	1846080000	G.98
SLD 5.08/26/90 3.2SN OR BX	1725280000	G.80	SLDV-THR 5.00/32/180GFLF 3.2SN BK BX	1911650000	G.31	SLF 5.08/06/180 SN OR BX	1335370000	G.102	SL5 5.08/11/180 SN OR BX	1627180000	G.96
SLD 5.08/28/180 3.2SN OR BX	1725770000	G.81	SLDV-THR 5.00/34/180F 3.2SN BK BX	1881420000	G.31	SLF 5.08/06/180B SN OR BX	1335480000	G.103	SL5 5.08/11/180B SN OR BX	1627330000	G.97
SLD 5.08/28/90 3.2SN OR BX	1725290000	G.80	SLDV-THR 5.00/34/180FLF 3.2SN BK BX	1883280000	G.31	SLF 5.08/06/180B SN OR BX	1335380000	G.102	SL5 5.08/11/180F SN OR BX	1846450000	G.97
SLD 5.08/30/180 3.2SN OR BX	1725780000	G.81	SLDV-THR 5.00/34/180G 3.2SN BK BX	1882810000	G.30	SLF 5.08/06/180F SN OR BX	1335630000	G.103	SL5 5.08/11/180F SN OR BX	1846300000	G.97
SLD 5.08/30/90 3.2SN OR BX	1725300000	G.80	SLDV-THR 5.00/34/180GFLF 3.2SN BK BX	1911660000	G.31	SLF 5.08/06/180F SN OR BX	1336440000	G.103	SL5 5.08/12/180 SN OR BX	1627190000	G.96
SLD 5.08/32/180 3.2SN OR BX	1725790000	G.81	SLDV-THR 5.00/36/180F 3.2SN BK BX	1881470000	G.31	SLF 5.08/07/180 SN OR BX	1335380000	G.102	SL5 5.08/12/180B SN OR BX	1627340000	G.97
SLD 5.08/32/90 3.2SN OR BX	1725310000	G.80	SLDV-THR 5.00/36/180FLF 3.2SN BK BX	1883290000	G.31	SLF 5.08/07/180 SN OR BX	1335490000	G.103	SL5 5.08/12/180B SN OR BX	1846460000	G.97
SLD 5.08/34/180 3.2SN OR BX	1725800000	G.81	SLDV-THR 5.00/36/180G 3.2SN BK BX	1882820000	G.30	SLF 5.08/07/180B SN OR BX	1335390000	G.102	SL5 5.08/12/180F SN OR BX	1846310000	G.97
SLD 5.08/34/90 3.2SN OR BX	1725320000	G.80	SLDV-THR 5.00/36/180GFLF 3.2SN BK BX	1911670000	G.31	SLF 5.08/07/180B SN OR BX	1335700000	G.103	SL5 5.08/12/180TB KF SN OR BX	1846320000	G.97
SLD 5.08/36/180 3.2SN OR BX	1725810000	G.81	SLDV-THR 5.00/38/180F 3.2SN BK BX	1883040000	G.31	SLF 5.08/07/180F SN OR BX	1336450000	G.103	SL5 5.08/12/180TB KF SN OR BX	1846090000	G.98
SLD 5.08/36/90 3.2SN OR BX	1725330000	G.80	SLDV-THR 5.00/38/180FLF 3.2SN BK BX	1883300000	G.31	SLF 5.08/07/180F SN OR BX	1335390000	G.102	SL5 5.08/13/180 SN OR BX	1627200000	G.96
SLD 5.08/38/180 3.2SN OR BX	1725820000	G.81	SLDV-THR 5.00/38/180G 3.2SN BK BX	1882830000	G.30	SLF 5.08/08/180 SN OR BX	1335510000	G.103	SL5 5.08/13/180B SN OR BX	1627350000	G.97
SLD 5.08/38/90 3.2SN OR BX	1725340000	G.80	SLDV-THR 5.00/38/180GFLF 3.2SN BK BX	1911680000	G.31	SLF 5.08/08/180B SN OR BX	1335650000	G.103	SL5 5.08/13/180F SN OR BX	1846470000	G.97
SLD 5.08/40/180 3.2SN OR BX	1725830000	G.81	SLDV-THR 5.00/40/180F 3.2SN BK BX	1881490000	G.31	SLF 5.08/08/180F SN OR BX	1335720000	G.103	SL5 5.08/13/180F SN OR BX	1846320000	G.97
SLD 5.08/40/90 3.2SN OR BX	1725350000	G.80	SLDV-THR 5.00/40/180FLF 3.2SN BK BX	1883310000	G.31	SLF 5.08/08/180F SN OR BX	1336470000	G.103	SL5 5.08/14/180 SN OR BX	1627210000	G.96
SLD 5.08/42/180 3.2SN OR BX	1725840000	G.81	SLDV-THR 5.00/40/180G 3.2SN BK BX	1882400000	G.30	SLF 5.08/09/180 SN OR BX	1335400000	G.102	SL5 5.08/14/180B SN OR BX	1627360000	G.97
SLD 5.08/42/90 3.2SN OR BX	1725360000	G.80	SLDV-THR 5.00/40/180GFLF 3.2SN BK BX	1911690000	G.31	SLF 5.08/09/180B SN OR BX	1335520000	G.103	SL5 5.08/14/180F SN OR BX	1846480000	G.97
SLD 5.08/44/180 3.2SN OR BX	1725850000	G.81	SLDV-THR 5.00/42/180F 3.2SN BK BX	1883050000	G.31	SLF 5.08/09/180B SN OR BX	1335760000	G.103	SL5 5.08/14/180F SN OR BX	1846330000	G.97
SLD 5.08/44/90 3.2SN OR BX	1725370000	G.80	SLDV-THR 5.00/42/180FLF 3.2SN BK BX	1883320000	G.31	SLF 5.08/09/180F SN OR BX	1335740000	G.103	SL5 5.08/15/180 SN OR BX	1627220000	G.96
SLD 5.08/46/180 3.2SN OR BX	1725860000	G.81	SLDV-THR 5.00/42/180G 3.2SN BK BX	1882840000	G.30	SLF 5.08/09/180F SN OR BX	1336480000	G.103	SL5 5.08/15/180B SN OR BX	1627370000	G.97
SLD 5.08/46/90 3.2SN OR BX	1725380000	G.80	SLDV-THR 5.00/42/180GFLF 3.2SN BK BX	1911710000	G.31	SLF 5.08/10/180 SN OR BX	1335410000	G.102	SL5 5.08/15/180B SN OR BX	1846490000	G.97
SLD 5.08/48/180 3.2SN OR BX	1725870000	G.81	SLDV-THR 5.00/44/180F 3.2SN BK BX	1883060000	G.31	SLF 5.08/10/180B SN OR BX	1335530000	G.103	SL5 5.08/15/180F SN OR BX	1846340000	G.97
SLD 5.08/48/90 3.2SN OR BX	1725390000	G.80	SLDV-THR 5.00/44/180FLF 3.2SN BK BX	1883330000	G.31	SLF 5.08/10/180B SN OR BX	1335680000	G.103	SL5 5.08/16/180 SN OR BX	1627230000	G.96
SLD 5.08/50/180 3.2SN OR BX	1599210000	G.84	SLDV-THR 5.00/44/180G 3.2SN BK BX	1882850000	G.30	SLF 5.08/10/180F SN OR BX	1335760000	G.103	SL5 5.08/16/180B SN OR BX	1627380000	G.97
SLD 5.08/50/90 3.2SN OR BX	1599220000	G.84	SLDV-THR 5.00/44/180GFLF 3.2SN BK BX	1911720000	G.31	SLF 5.08/11/180 SN OR BX	1336490000	G.103	SL5 5.08/16/180F SN OR BX	1846500000	G.97
SLD 5.08/52/180 3.2SN OR BX	1599230000	G.84	SLDV-THR 5.00/46/180F 3.2SN BK BX	1883070000	G.31	SLF 5.08/11/180B SN OR BX	1335420000	G.102	SL5 5.08/16/180F SN OR BX	1846350000	G.97
SLD 5.08/52/90 3.2SN OR BX	1599240000	G.84	SLDV-THR 5.00/46/180FLF 3.2SN BK BX	1883340000	G.31	SLF 5.08/11/180B SN OR BX	1335540000	G.103	SL5 5.08/16/180TB KF SN OR BX	1846180000	G.99
SLD 5.08/54/180 3.2SN OR BX	1599250000	G.84	SLDV-THR 5.00/46/180G 3.2SN BK BX	1882860000	G.30	SLF 5.08/11/180B SN OR BX	1335780000	G.103	SL5 5.08/16/180TB KF SN OR BX	1846100000	G.98
SLD 5.08/54/90 3.2SN OR BX	1599260000	G.84	SLDV-THR 5.00/46/180								

Type	Order No.	Page	Type	Order No.	Page	Type	Order No.	Page	Type	Order No.	Page
SLT 5.08/11/180B SN DR BX	1611800000	G.100	SU 10.16HP/06/90SF 3.5AG BK BX	1851080000	K.187	SV 762HP/03/270MSF3 SC/04R SN BK BX	1089610000	K.31	SV 762HP/05/270MF3 3.5SN BK BX	1048640000	K.129
SLT 5.08/12/180B SN DR BX	1611810000	G.100	SU 10.16HP/07/180F 3.5AG BK BX	1813700000	K.191	SV 762HP/03/270MSF3 SC/06R SN BK BX	1089670000	K.31	SV 762HP/05/270MF3 SC/04R SN BK BX	1156300000	K.29
SLT 5.08/13/180B SN DR BX	1611820000	G.100	SU 10.16HP/07/180G 3.5AG BK BX	1813460000	K.191	SV 762HP/03/270MSF3 SC/08R SN BK BX	1156220000	K.31	SV 762HP/05/270MF3 SC/06R SN BK BX	1156310000	K.29
SLT 5.08/14/180B SN DR BX	1611830000	G.100	SU 10.16HP/07/180SF 3.5AG BK BX	1850930000	K.190	SV 762HP/03/270SF 3.5SN BK BX	1931490000	K.127	SV 762HP/05/270MF3 SC/08R SN BK BX	1156320000	K.29
SLT 5.08/15/180B SN DR BX	1611840000	G.100	SU 10.16HP/07/270F 3.5AG BK BX	1813780000	K.193	SV 762HP/03/90F 3.5SN BK BX	1930390000	K.119	SV 762HP/05/270MF3 4.5SN BK BX	1048650000	K.129
SLT 5.08/16/180B SN DR BX	1611850000	G.100	SU 10.16HP/07/270G 3.5AG BK BX	1813540000	K.192	SV 762HP/03/90G 3.5SN BK BX	1930280000	K.118	SV 762HP/05/270MF4 SC/04R SN BK BX	1093030000	K.29
SLZ 7.62HP/02/180F SN BK BX	1043430000	K.89	SU 10.16HP/07/270SF 3.5AG BK BX	1851170000	K.193	SV 762HP/03/90G SC/04R SN BK BX	1090040000	K.20	SV 762HP/05/270MF4 SC/06R SN BK BX	1090380000	K.29
SLZ 7.62HP/02/180G SN BK BX	1043350000	K.88	SU 10.16HP/07/90F 3.5AG BK BX	1813620000	K.187	SV 762HP/03/90G SC/06R SN BK BX	1090120000	K.20	SV 762HP/05/270MF4 SC/08R SN BK BX	1156340000	K.29
SLZ 7.62HP/02/180L SN BK BX	1043510000	K.89	SU 10.16HP/07/90G 3.5AG BK BX	1813380000	K.186	SV 762HP/03/90G SC/08R SN BK BX	1157050000	K.20	SV 762HP/05/270MF2 SC/04R SN BK BX	2628090000	K.30
SLZ 7.62HP/03/180F SN BK BX	1043440000	K.89	SU 10.16HP/07/90SF 3.5AG BK BX	1851090000	K.187	SV 762HP/03/90MF2 3.5SN BK BX	1048490000	K.121	SV 762HP/05/270MF2 SC/06R SN BK BX	2628090000	K.30
SLZ 7.62HP/03/180G SN BK BX	1043360000	K.88	SU 10.16HP/08/180F 3.5AG BK BX	1813710000	K.191	SV 762HP/03/90MF2 SC/04R SN BK BX	1156230000	K.22	SV 762HP/05/270MF2 SC/08R SN BK BX	2628100000	K.30
SLZ 7.62HP/03/180L SN BK BX	1043520000	K.89	SU 10.16HP/08/180G 3.5AG BK BX	1813470000	K.190	SV 762HP/03/90MF2 SC/06R SN BK BX	1156240000	K.22	SV 762HP/05/270MF3 SC/04R SN BK BX	1156370000	K.31
SLZ 7.62HP/04/180F SN BK BX	1043450000	K.89	SU 10.16HP/08/180SF 3.5AG BK BX	1850940000	K.191	SV 762HP/03/90MF2 SC/08R SN BK BX	1156840000	K.22	SV 762HP/05/270MF3 SC/06R SN BK BX	1156390000	K.31
SLZ 7.62HP/04/180G SN BK BX	1043370000	K.88	SU 10.16HP/08/270F 3.5AG BK BX	1813790000	K.193	SV 762HP/03/90MF3 3.5SN BK BX	1048500000	K.120	SV 762HP/05/270MF3 SC/08R SN BK BX	1156410000	K.31
SLZ 7.62HP/04/180L SN BK BX	1043530000	K.89	SU 10.16HP/08/270G 3.5AG BK BX	1813550000	K.192	SV 762HP/03/90MF3 SC/04R SN BK BX	1089660000	K.23	SV 762HP/05/270MF4 SC/04R SN BK BX	1090540000	K.31
SLZ 7.62HP/05/180F SN BK BX	1043460000	K.89	SU 10.16HP/08/270SF 3.5AG BK BX	1851180000	K.193	SV 762HP/03/90MF3 SC/06R SN BK BX	1089730000	K.23	SV 762HP/05/270MF4 SC/06R SN BK BX	1090610000	K.31
SLZ 7.62HP/05/180G SN BK BX	1043380000	K.88	SU 10.16HP/08/90F 3.5AG BK BX	1813630000	K.187	SV 762HP/03/90MF3 SC/08R SN BK BX	1156850000	K.23	SV 762HP/05/270MF5 SC/04R SN BK BX	1156430000	K.31
SLZ 7.62HP/05/180L SN BK BX	1043540000	K.89	SU 10.16HP/08/90G 3.5AG BK BX	1813390000	K.186	SV 762HP/03/90MF2 SC/04R SN BK BX	1156250000	K.24	SV 762HP/05/270SF 3.5SN BK BX	1931510000	K.127
SMSE 1 MSD ZB	4060540000	N.40	SU 10.16HP/08/90SF 3.5AG BK BX	1851100000	K.187	SV 762HP/03/90MF2 SC/06R SN BK BX	1156270000	K.24	SV 762HP/05/90F 3.5SN BK BX	1930410000	K.119
SMSE FE MCZ 1.5/PE	1003280000	N.41	SU 10.16HP/09/180F 3.5AG BK BX	1813720000	K.191	SV 762HP/03/90MF2 SC/08R SN BK BX	1156870000	K.24	SV 762HP/05/90G 3.5SN BK BX	1930300000	K.118
SMSE FE MSA	2279350000	N.40	SU 10.16HP/09/180G 3.5AG BK BX	1813480000	K.190	SV 762HP/03/90MF3 SC/04R SN BK BX	1089890000	K.25	SV 762HP/05/90G SC/04R SN BK BX	1900520000	K.20
SMSE KU FE MCZ 1.5	2224390000	N.41	SU 10.16HP/09/180SF 3.5AG BK BX	1850950000	K.191	SV 762HP/03/90MF3 SC/06R SN BK BX	1089970000	K.25	SV 762HP/05/90G SC/06R SN BK BX	1909509000	K.20
SMSE LN FE MCZ 1.5	2242830000	N.41	SU 10.16HP/09/270F 3.5AG BK BX	1813800000	K.193	SV 762HP/03/90MF3 SC/08R SN BK BX	1156880000	K.25	SV 762HP/05/90G SC/08R SN BK BX	1157080000	K.20
SMSE MSA ZB	4286260000	N.40	SU 10.16HP/09/270G 3.5AG BK BX	1813560000	K.192	SV 762HP/03/90F3 3.5SN BK BX	1930500000	K.119	SV 762HP/05/90MF2 3.5SN BK BX	1464280000	K.120
SMSEZ ZF MSD	2277800000	N.40	SU 10.16HP/09/270SF 3.5AG BK BX	1851190000	K.193	SV 762HP/04/180F 3.5SN BK BX	1930730000	K.123	SV 762HP/05/90MF2 SC/04R SN BK BX	2628170000	K.22
SR-SMD 4.50/05/90 AU BK BX	1155840000	N.34	SU 10.16HP/09/90F 3.5AG BK BX	1813640000	K.187	SV 762HP/04/180G3 3.5SN BK BX	1930620000	K.122	SV 762HP/05/90MF2 SC/06R SN BK BX	2628180000	K.22
SR-SMD 4.50/05/90 AU BL RL	1155850000	N.35	SU 10.16HP/09/90G 3.5AG BK BX	1813400000	K.186	SV 762HP/04/180MF2 3.5SN BK BX	1464310000	K.124	SV 762HP/05/90MF2 SC/08R SN BK BX	2628190000	K.22
SR-SMD 4.50/05/90LF 1.5AU BK BX	1155890000	N.34	SU 10.16HP/09/90SF 3.5AG BK BX	1851110000	K.187	SV 762HP/04/270MF3 3.5SN BK BX	1048530000	K.125	SV 762HP/05/90MF3 3.5SN BK BX	1048680000	K.121
SR-SMD 4.50/05/90LF 1.5AU BL RL	1155900000	N.35	SU 10.16HP/09/90SF 3.5AG BK BX	1851110000	K.187	SV 762HP/04/180MF3 4.5SN BK BX	1464330000	K.125	SV 762HP/05/90MF3 SC/04R SN BK BX	1156910000	K.23
SR-SMD 4.50/05/90LFM 3.2AU BK BX	1155870000	N.35	SU 10.16IT/02/270MF2 3.5AG BK BX SO	1157310000	K.68	SV 762HP/04/180MF3 3.5SN BK BX	1930840000	K.123	SV 762HP/05/90MF3 SC/06R SN BK BX	1156930000	K.23
SR-SMD 4.50/05/90LFM 3.2AU BL RL	1155880000	N.35	SU 10.16IT/02/270MF2 3.5AG BK BX	1157320000	K.68	SV 762HP/04/270F 3.5SN BK BX	1931390000	K.127	SV 762HP/05/90MF3 SC/08R SN BK BX	1156950000	K.23
SU 10.16HP/02/180F 3.5AG BK BX	1813650000	K.191	SU 10.16IT/03/270MF3 3.5AG BK BX	1157330000	K.69	SV 762HP/04/270G 3.5SN BK BX	1931280000	K.126	SV 762HP/05/90MF4 3.5SN BK BX	1048690000	K.121
SU 10.16HP/02/180G 3.5AG BK BX	1813410000	K.190	SU 10.16IT/03/90MF2 3.5AG BK BX	1156670000	K.66	SV 762HP/04/270G SC/04R SN BK BX	1091120000	K.26	SV 762HP/05/90MF4 SC/04R SN BK BX	1090600000	K.23
SU 10.16HP/02/180SF 3.5AG BK BX	1850880000	K.191	SU 10.16IT/03/90MF3 3.5AG BK BX	1156680000	K.67	SV 762HP/04/270G SC/06R SN BK BX	1091160000	K.26	SV 762HP/05/90MF4 SC/06R SN BK BX	1090670000	K.23
SU 10.16HP/02/270F 3.5AG BK BX	1813730000	K.193	SU 10.16IT/04/270MF2 3.5AG BK BX	1157340000	K.68	SV 762HP/04/270G SC/08R SN BK BX	1156970000	K.26	SV 762HP/05/90MF4 SC/08R SN BK BX	1156980000	K.23
SU 10.16HP/02/270G 3.5AG BK BX	1813490000	K.192	SU 10.16IT/04/270MF3 3.5AG BK BX SO	2630190000	K.69	SV 762HP/04/270MF2 3.5SN BK BX	1464340000	K.128	SV 762HP/05/90MF2 SC/04R SN BK BX	2628260000	K.24
SU 10.16HP/02/270MF2 3.5AG BK BX	2580350000	K.194	SU 10.16IT/04/270MF4 3.5AG BK BX	1157350000	K.69	SV 762HP/04/270MF2 SC/04R SN BK BX	2627960000	K.128	SV 762HP/05/90MF2 SC/06R SN BK BX	2628270000	K.24
SU 10.16HP/02/270SF 3.5AG BK BX	1851120000	K.193	SU 10.16IT/04/90MF2 3.5AG BK BX	1156690000	K.66	SV 762HP/04/270MF2 SC/06R SN BK BX	2627970000	K.28	SV 762HP/05/90MF2 SC/08R SN BK BX	2628280000	K.24
SU 10.16HP/02/90F 3.5AG BK BX	1813570000	K.187	SU 10.16IT/04/90MF3 3.5AG BK BX SO	2629720000	K.67	SV 762HP/04/270MF2 SC/08R SN BK BX	2627980000	K.28	SV 762HP/05/90MF3 SC/04R SN BK BX	1157000000	K.25
SU 10.16HP/02/90G 3.5AG BK BX	1813330000	K.186	SU 10.16IT/04/90MF4 3.5AG BK BX	1156700000	K.67	SV 762HP/04/270MF2 3.5SN BK BX	1048550000	K.129	SV 762HP/05/90MF3 SC/06R SN BK BX	1157010000	K.25
SU 10.16HP/02/90MF2 3.5AG BK BX	2580340000	K.188	SUZ 10.16HP/02/180G AG BK BX	1947480000	K.196	SV 762HP/04/270MF3 SC/04R SN BK BX	2628020000	K.29	SV 762HP/05/90MF3 SC/08R SN BK BX	1157020000	K.25
SU 10.16HP/02/90SF 3.5AG BK BX	1851040000	K.187	SUZ 10.16HP/03/180G AG BK BX	1947490000	K.196	SV 762HP/04/270MF3 SC/06R SN BK BX	2628030000	K.29	SV 762HP/05/90MF4 SC/04R SN BK BX	1090830000	K.25
SU 10.16HP/03/180F 3.5AG BK BX	1813660000	K.191	SUZ 10.16HP/04/180G AG BK BX	1947500000	K.196	SV 762HP/04/270MF3 SC/08R SN BK BX	2628040000	K.29	SV 762HP/05/90MF4 SC/06R SN BK BX	1090900000	K.25
SU 10.16HP/03/180G 3.5AG BK BX	1813420000	K.190	SUZ 10.16HP/05/180G AG BK BX	1947510000	K.196	SV 762HP/04/270MF4 3.5SN BK BX	1464360000	K.129	SV 762HP/05/90MF4 SC/08R SN BK BX	1157030000	K.25
SU 10.16HP/03/180SF 3.5AG BK BX	1850890000	K.191	SUZ 10.16HP/06/180G AG BK BX	1966920000	K.196	SV 762HP/04/270MF4 SC/04R SN BK BX	1089820000	K.29	SV 762HP/05/90SF 3.5SN BK BX	1930520000	K.119
SU 10.16HP/03/270F 3.5AG BK BX	1813740000	K.193	SUZ 10.16HP/07/180G AG BK BX	1966930000	K.196	SV 762HP/04/270MF4 SC/06R SN BK BX	1089910000	K.29	SV 762HP/06/180F 3.5SN BK BX	1930750000	K.123
SU 10.16HP/03/270G 3.5AG BK BX	1813500000	K.192	SUZ 10.16HP/08/180G AG BK BX	1962440000	K.196	SV 762HP/04/270MF4 SC/08R SN BK BX	1156280000	K.29	SV 762HP/06/180G 3.5SN BK BX	1930640000	K.123
SU 10.16HP/03/270MF2 3.5AG BK BX	2580830000	K.194	SUZ 10.16HP/09/180G AG BK BX	1966910000	K.196	SV 762HP/04/270MF2 SC/04R SN BK BX	2628050000	K.30	SV 762HP/06/180MF2 3.5SN BK BX	1543190000	K.124
SU 10.16HP/03/270SF 3.5AG BK BX	2580850000	K.195	SV 7.62HP/02/180F 3.5SN BK BX	1930710000	K.123	SV 762HP/04/270MF2 SC/06R SN BK BX	2628060000	K.30	SV 762HP/06/180MF3 3.5SN BK BX	1543210000	K.124
SU 10.16HP/03/270SF 3.5AG BK BX	1851130000	K.193	SV 7.62HP/02/180G 3.5SN BK BX	1930600000	K.122	SV 762HP/04/270MF2 SC/08R SN BK BX	2628070000	K.30	SV 762HP/06/180MF4 3.5SN BK BX	1543220000	K.124
SU 10.16HP/03/90F 3.5AG BK BX	1813580000	K.187	SV 7.62HP/02/180MF2 3.5SN BK BX	1048350000	K.124	SV 762HP/04/270MF3 SC/04R SN BK BX	2628110000	K.31	SV 762HP/06/180SF 3.5SN BK BX	1930860000	K.123
SU 10.16HP/03/90G 3.5AG BK BX	1813400000	K.186	SV 7.62HP/02/180SF 3.5SN BK BX	1930820000	K.123	SV 762HP/04/270MF3 SC/06R SN BK BX	2628120000	K.31	SV 762HP/06/270F 3.5SN BK BX	1931410000	K.127
SU 10.16HP/03/90MF2 3.5AG BK BX	2580390000	K.188	SV 7.62HP/02/270F 3.5SN BK BX	1931370000	K.127	SV 762HP/04/270MF3 SC/08R SN BK BX	2628130000	K.31	SV 762HP/06/270G 3.5SN BK BX	1931300000	K.126
SU 10.16HP/03/90MF3 3.5AG BK BX	2580440000	K.189	SV 7.62HP/02/270G 3.5SN BK BX	1931260000	K.126	SV 762HP/04/270MF4 SC/04R SN BK BX	1090060000	K.31	SV 762HP/06/270SF 3.5SN BK BX	1543250000	K.128
SU 10.16HP/03/90SF 3.5AG BK BX	1851050000	K.187	SV 7.62HP/02/270G SC/04R SN BK BX	1090770000	K.26	SV 762HP/04/270MF4 SC/06R SN BK BX	1090140000	K.31	SV 762HP/06/270MF3 3.5SN BK BX	1543260000	K.129
SU 10.16HP/04/180F 3.5AG BK BX	1813670000	K.191	SV 7.62HP/02/270G SC/06R SN BK BX	1090850000	K.26	SV 762HP/04/270MF4 SC/08R SN BK BX	1156290000	K.31	SV 762HP/06/270MF4 3.5SN BK BX	1048740000	K.129
SU 10.16HP/04/180G 3.5AG BK BX	1813430000	K.190	SV 7.62HP/02/270G SC/08R SN BK BX	1156920000	K.26	SV 7.62HP/04/270SF 3.5SN BK BX	1931500000	K.127	SV 762HP/06/270SF 3.5SN BK BX	1931520000	K.127
SU 10.16HP/04/180SF 3.5AG BK BX	1850900000	K.191	SV 7.62HP/02/270MF2 3.5SN BK BX	1048370000	K.128	SV 7.62HP/04/90F 3.5SN BK BX	1930400000	K.119	SV 762HP/06/90F 3.5SN BK BX	1930420000	K.119
SU 10.16HP/04/270F 3.5AG BK BX	1813750000	K.193	SV 7.62HP/02/270MF2 SC/04R SN BK BX	1092860000	K.28	SV 7.62HP/04/90G 3.5SN BK BX	1930200000	K.118	SV 762HP/06/90G 3.5SN BK BX	1930310000	K.118
SU 10.16HP/04/270G 3.5AG BK BX	1813510000	K.192	SV 7.62HP/02/270MF2 SC/06R SN BK BX	1092890000</							

Table with 3 columns: Type, Order No., Page. Contains product information for SV-7.6ZHP/11/180F 3.5SN BK BX and SV-SMT 7.6ZHP/03/90SF 2.6SN BK BX.

Table with 3 columns: Type, Order No., Page. Contains product information for SV-SMT 7.6ZHP/03/90MSF3 SC/8 2.6SN BX and SV-SMT 7.6ZHP/03/90SF 2.6SN BK BX.

Table with 3 columns: Type, Order No., Page. Contains product information for SV-SMT 7.6ZHP/05/90MF4 SC/8 2.6SN BX and SV-SMT 7.6ZHP/05/90MSF2 SC/4 2.6SN BX.

Table with 3 columns: Type, Order No., Page. Contains product information for SVFL 7.6ZHP/04/180MF2 SN BK BX and SVFL 7.6ZHP/04/180MF3 SN BK BX.

Type	Order No.	Page
TOP1.56S21/90 5 2STI OR	0595160000	C.36
TOP1.56S22/180 5 2STI OR	0598860000	C.37
TOP1.56S22/90 5 2STI OR	0595260000	C.36
TOP1.56S23/180 5 2STI OR	0598960000	C.37
TOP1.56S23/90 5 2STI OR	0595360000	C.36
TOP1.56S24/180 5 2STI OR	0599060000	C.37
TOP1.56S24/90 5 2STI OR	0595460000	C.36
TOP1.56S3/180 5 2STI OR	0570160000	C.37
TOP1.56S3/180 7 2STI OR	0391460000	C.39
TOP1.56S3/90 5 2STI OR	0642060000	C.36
TOP1.56S3/90 7 2STI OR	0393460000	C.38
TOP1.56S4/180 5 2STI OR	0570360000	C.37
TOP1.56S4/180 7 2STI OR	0391560000	C.39
TOP1.56S4/90 5 2STI OR	0642160000	C.36
TOP1.56S4/90 7 2STI OR	0393560000	C.38
TOP1.56S5/180 5 2STI OR	0597360000	C.37
TOP1.56S5/180 7 2STI OR	1490460000	C.39
TOP1.56S5/90 5 2STI OR	1578820000	C.36
TOP1.56S5/90 7 2STI OR	0393860000	C.38
TOP1.56S6/180 5 2STI OR	0597460000	C.37
TOP1.56S6/180 7 2STI OR	1597060000	C.39
TOP1.56S6/90 5 2STI OR	0593860000	C.36
TOP1.56S6/90 7 2STI OR	1683990000	C.38
TOP1.56S7/180 5 2STI OR	1695700000	C.37
TOP1.56S7/180 7 2STI OR	1597070000	C.39
TOP1.56S7/90 5 2STI OR	0593960000	C.36
TOP1.56S7/90 7 2STI OR	1647310000	C.38
TOP1.56S8/180 5 2STI OR	0597660000	C.37
TOP1.56S8/180 7 2STI OR	0570960000	C.39
TOP1.56S8/90 5 2STI OR	0594060000	C.36
TOP1.56S8/90 7 2STI OR	0642460000	C.38
TOP1.56S9/180 5 2STI OR	1474660000	C.37
TOP1.56S9/180 7 2STI OR	1597080000	C.39
TOP1.56S9/90 5 2STI OR	0594160000	C.36
TOP1.56S9/90 7 2STI OR	0393960000	C.38
TOP4GS10/180 6.35 OR	1786270000	C.41
TOP4GS10/180 7.62 OR	1786570000	C.43
TOP4GS10/90 6.35 OR	1786080000	C.40
TOP4GS10/90 7.62 OR	1786440000	C.42
TOP4GS11/180 6.35 OR	1786280000	C.41
TOP4GS11/180 7.62 OR	1786580000	C.43
TOP4GS11/90 6.35 OR	1786090000	C.40
TOP4GS11/90 7.62 OR	1759860000	C.42
TOP4GS12/180 6.35 OR	1786290000	C.41
TOP4GS12/180 7.62 OR	1749170000	C.43
TOP4GS12/90 6.35 OR	1786100000	C.40
TOP4GS12/90 7.62 OR	1786450000	C.42
TOP4GS2/180 6.35 OR	1786190000	C.41
TOP4GS2/180 7.62 OR	0298360000	C.43
TOP4GS2/90 6.35 OR	1401760000	C.40
TOP4GS2/90 7.62 OR	0298660000	C.42
TOP4GS3/180 6.35 OR	1786200000	C.41
TOP4GS3/180 7.62 OR	0298460000	C.43
TOP4GS3/90 6.35 OR	1650300000	C.40
TOP4GS3/90 7.62 OR	0289760000	C.42
TOP4GS4/180 6.35 OR	1786210000	C.41
TOP4GS4/180 7.62 OR	0298560000	C.43
TOP4GS4/90 6.35 OR	1786030000	C.40
TOP4GS4/90 7.62 OR	0290160000	C.42
TOP4GS5/180 6.35 OR	1786220000	C.41
TOP4GS5/180 7.62 OR	1786540000	C.43
TOP4GS5/90 6.35 OR	1786040000	C.40
TOP4GS5/90 7.62 OR	1698740000	C.42
TOP4GS6/180 6.35 OR	1786230000	C.41
TOP4GS6/180 7.62 OR	1494560000	C.43
TOP4GS6/90 6.35 OR	1786050000	C.40
TOP4GS6/90 7.62 OR	1786410000	C.42
TOP4GS7/180 6.35 OR	1786240000	C.41
TOP4GS7/180 7.62 OR	1786550000	C.43
TOP4GS7/90 6.35 OR	1786060000	C.40
TOP4GS7/90 7.62 OR	1647300000	C.42
TOP4GS8/180 6.35 OR	1786250000	C.41
TOP4GS8/180 7.62 OR	1786560000	C.43
TOP4GS8/90 6.35 OR	1667910000	C.40
TOP4GS8/90 7.62 OR	1786420000	C.42
TOP4GS9/180 6.35 OR	1786260000	C.41
TOP4GS9/180 7.62 OR	1571700000	C.43
TOP4GS9/90 6.35 OR	1786070000	C.40
TOP4GS9/90 7.62 OR	1786430000	C.42
TS 35X15/LL 1M/ST/ZN	0236510000	N.37
TS 35X7.5/LL 1M/ST/ZN	0514510000	N.37

## U

USB2.0A RIV 2.5N4 TY BK	2563730000	B.46
USB2.0A S1H 1.4N4 TY BK	2563720000	B.44
USB2.0A T1H 2.5N4 TY BK	2563710000	B.50
USB2.0A T1V 2.5N4 TY BK	1985910000	B.48
USB3.0A RIV 3.0N2 TY BL	1549730000	B.47
USB3.0A T1H 2.3N4 TY BL	2563550000	B.51

## V

VDS180 SV7.62	1853940000	K.122
VDS180 SV7.62	1853940000	K.124
VDS180 SV7.62	1853940000	K.176
VDS180 SV7.62	1853940000	K.190
VDS180 SV7.62	1853940000	M.4
VREL PGK4 OR VPE 30	1288610000	L.10

Type	Order No.	Page
VWVG 4 BK BX	1250650000	L.13
VWVG 4 GN/YE BX	1936480000	L.13
VWVG 4 GY BX	1936490000	L.13
VWVG 6 BK BX	2484810000	L.14
VWVG 6 GN/YE BX	2484680000	L.14
VWVG 6 GY BX	2484800000	L.14

## W

WGK 10 BK BX	2439470000	L.16
WGK 10 GN/YE BX	2439380000	L.16
WGK 10 GY BX	2439390000	L.16
WGK 10 VP GN/YE BX	2439430000	L.17
WGK 10 VP GY BX	2439450000	L.17
WGK 10 VP/Z GN/YE BX	2439440000	L.17
WGK 10 VP/Z GY BX	2439420000	L.17
WGK 10/Z BK BX	2439460000	L.16
WGK 10/Z GN/YE BX	2439400000	L.16
WGK 10/Z GY BX	2439410000	L.16
WGK 16 BK BX	2440590000	L.18
WGK 16 GN/YE BX	2439600000	L.18
WGK 16 GY BX	2440560000	L.18
WGK 16 VP BK BX	2440660000	L.19
WGK 16 VP GN/YE BX	2440610000	L.19
WGK 16 VP GY BX	2440620000	L.19
WGK 16 VP/Z BK BX	2440710000	L.19
WGK 16 VP/Z GN/YE BX	2440630000	L.19
WGK 16 VP/Z GY BX	2440640000	L.19
WGK 16/Z BK BX	2440600000	L.18
WGK 16/Z GN/YE BX	2440570000	L.18
WGK 16/Z GY BX	2440580000	L.18
WGK 25 BK BX	2444670000	L.20
WGK 25 GN/YE BX	2444650000	L.20
WGK 25 GY BX	2444660000	L.20
WGK 25 VP BK BX	2444800000	L.21
WGK 25 VP GN/YE BX	2444700000	L.21
WGK 25 VP GY BX	2444710000	L.21
WGK 25 VP/Z BK BX	2444790000	L.21
WGK 25 VP/Z GN/YE BX	2444720000	L.21
WGK 25 VP/Z GY BX	2444730000	L.21
WGK 25/Z BK BX	2444680000	L.20
WGK 25/Z GN/YE BX	2444640000	L.20
WGK 25/Z GY BX	2444300000	L.20
WGK 4 BK BX	1250930000	L.12
WGK 4 GN/YE BX	1936540000	L.12
WGK 4 GY BX	1936550000	L.12
WGK 4 VP BK BX	1339790000	L.13
WGK 4 VP GN/YE BX	1003890000	L.13
WGK 4 VP GY BX	1981890000	L.13
WGK 4 VP/Z BK BX	1339810000	L.13
WGK 4 VP/Z GN/YE BX	1003900000	L.13
WGK 4 VP/Z GY BX	1003910000	L.13
WGK 4/Z BK BX	1250940000	L.12
WGK 4/Z GN/YE BX	1936560000	L.12
WGK 4/Z GY BX	1936570000	L.12
WGK 50 BK BX	2427680000	L.22
WGK 50 GN/YE BX	2427660000	L.22
WGK 50 GY BX	2427640000	L.22
WGK 50 VP BK BX	2428440000	L.23
WGK 50 VP GN/YE BX	2428270000	L.23
WGK 50 VP GY BX	2428280000	L.23
WGK 50 VP/Z GY BX	2428300000	L.23
WGK 50 VP/Z BK BX	2428450000	L.23
WGK 50 VP/Z GN/YE BX	2428290000	L.23
WGK 50/Z BK BX	2427690000	L.22
WGK 50/Z GN/YE BX	2427810000	L.22
WGK 50/Z GY BX	2427650000	L.22
WGK 95 BK BX	1250680000	L.24
WGK 95 GN/YE BX	1937370000	L.24
WGK 95 GY BX	1937380000	L.24
WGK 95/Z BK BX	1250690000	L.24
WGK 95/Z GN/YE BX	1937390000	L.24
WGK 95/Z GY BX	1937400000	L.24
WGK 95F VP BK BX	1250660000	L.25
WGK 95F VP GN/YE BX	1937120000	L.25
WGK 95F VP GY BX	1937130000	L.25
WGK 95F VP/Z BK BX	1250670000	L.25
WGK 95F VP/Z GN/YE BX	1937360000	L.25
WGK 95F VP/Z GY BX	1937140000	L.25
WGKV 10 BK BX	2439570000	L.17
WGKV 10 GN/YE BX	2439530000	L.17
WGKV 10 GY BX	2439520000	L.17
WGKV 10/Z BK BX	2439580000	L.17
WGKV 10/Z GN/YE BX	2439540000	L.17
WGKV 10/Z GY BX	2439550000	L.17
WGKV 16 BK BX	2440790000	L.19
WGKV 16 GN/YE BX	2440740000	L.19
WGKV 16 GY BX	2440750000	L.19
WGKV 16/Z BK BX	2440800000	L.19
WGKV 16/Z GN/YE BX	2440720000	L.19
WGKV 16/Z GY BX	2440730000	L.19
WGKV 25 BK BX	2444840000	L.21
WGKV 25 GN/YE BX	2444830000	L.21
WGKV 25 GY BX	2444820000	L.21
WGKV 25/Z BK BX	2444870000	L.21
WGKV 25/Z GN/YE BX	2444810000	L.21
WGKV 25/Z GY BX	2444860000	L.21
WGKV 4 BK BX	1250950000	L.13
WGKV 4 GN/YE BX	1936610000	L.13

Type	Order No.	Page
WGKV 4 GY BX	1934050000	L.13
WGKV 4/Z BK BX	1250960000	L.13
WGKV 4/Z GN/YE BX	1936620000	L.13
WGKV 4/Z GY BX	1936630000	L.13
WS 10/5 MC NE WS	1635000000	L.18
WS 10/5 MC NE WS	1635000000	N.52
WS 12/5 MC NE WS	1609860000	L.18
WS 12/5 MC NE WS	1609860000	N.52
WSM TOOL AUTOMATIK	1774470000	K.40

## Z

ZBSC DL12.5/M2.5X6 SET	1919670000	N.40
ZDV 4N/2 BL	1793960000	N.40
ZDV 4N/2 BL	1793960000	N.41
ZDV 4N/2 GE	1758250000	N.40
ZDV 4N/2 GE	1758250000	N.41
ZDV 4N/2 RT	1793950000	N.40
ZDV 4N/2 RT	1793950000	N.41
ZW 15 RS OR	0119860000	N.47
ZW 25 RS OR	0126160000	N.47
ZW 30 RS OR	0119960000	N.47
ZW 45 RS OR	0120060000	N.47
ZW 5 RS OR	0119760000	N.47





Order No.	Type	Page
-----------	------	------

## 011000000

0119560000	RF RS 70 RE/A3/M.BEZ OR	N.47
0119660000	RF RS 70 LI/A2/O.SG OR 1665	N.47
0119760000	ZW 5 RS OR	N.47
0119860000	ZW 15 RS OR	N.47
0119960000	ZW 30 RS OR	N.47

## 012000000

0120060000	ZW 45 RS OR	N.47
0126160000	ZW 25 RS OR	N.47
0126260000	RF RS 70 RE/A4/O.BEZ OR	N.47

## 015000000

0157261187	DEK 5 GS PE	L.17
0157261187	DEK 5 GS PE	M.7
0157261202	DEK 5 GS ERDE	L.17
0157261202	DEK 5 GS ERDE	M.7
0157261203	DEK 5 GS ERDEIM KREIS	L.17
0157261203	DEK 5 GS ERDEIM KREIS	M.7

## 018000000

0180400000	PS 2.3 RT	L.10
------------	-----------	------

## 021000000

0213760000	RF RS 70 MI/A6 OR	N.47
------------	-------------------	------

## 023000000

0236510000	TS 35X15/LL 1M/ST/ZN	N.37
------------	----------------------	------

## 028000000

0289660000	TOP4GS2/90 7.62 OR	C.42
0289760000	TOP4GS3/90 7.62 OR	C.42

## 029000000

0290160000	TOP4GS4/90 7.62 OR	C.42
0298360000	TOP4GS2/180 7.62 OR	C.43
0298460000	TOP4GS3/180 7.62 OR	C.43
0298560000	TOP4GS4/180 7.62 OR	C.43

## 031000000

0310000000	PS 2.0 MC	C.90
0310000000	PS 2.0 MC	C.92
0310000000	PS 2.0 MC	L.15
0310000000	PS 2.0 MC	J.19
0310000000	PS 2.0 MC	J.20
0310000000	PS 2.0 MC	J.21
0310000000	PS 2.0 MC	J.22
0310000000	PS 2.0 MC	J.24
0310000000	PS 2.0 MC	J.26
0310000000	PS 2.0 MC	J.27
0310000000	PS 2.0 MC	J.28
0310000000	PS 2.0 MC	J.29
0310000000	PS 2.0 MC	J.30
0310000000	PS 2.0 MC	J.31
0310000000	PS 2.0 MC	J.32
0310000000	PS 2.0 MC	J.33
0310000000	PS 2.0 MC	J.34
0310000000	PS 2.0 MC	J.35
0310000000	PS 2.0 MC	J.36
0310000000	PS 2.0 MC	J.37
0310000000	PS 2.0 MC	J.38
0310000000	PS 2.0 MC	J.39
0310000000	PS 2.0 MC	J.40
0310000000	PS 2.0 MC	J.41
0310000000	PS 2.0 MC	M.4

## 033000000

0331500001	SF 10 BEZ 1-10	L.18
0331500011	SF 10 BEZ 11-20	L.18
0332400000	SF 10 BEZ 0-9	L.18
0332500000	SG 10	L.18
0332500001	SG 10 BEZ 1	L.18
0332500002	SG 10 BEZ 2	L.18
0332500003	SG 10 BEZ 3	L.18
0332500004	SG 10 BEZ 4	L.18
0332500005	SG 10 BEZ 5	L.18
0332500006	SG 10 BEZ 6	L.18
0332500007	SG 10 BEZ 7	L.18
0332500008	SG 10 BEZ 8	L.18
0332500009	SG 10 BEZ 9	L.18

## 035000000

0354361187	DEK 5 FWZ L1-PE	L.17
0354361187	DEK 5 FWZ L1-PE	M.7

## 039000000

0391360000	TOP1.5GS2/180 7.2STI OR	C.39
------------	-------------------------	------

Order No.	Type	Page
-----------	------	------

0391460000	TOP1.5GS3/180 7.2STI OR	C.39
0391560000	TOP1.5GS4/180 7.2STI OR	C.39
0392160000	TOP1.5GS12/180 7.2STI OR	C.39
0393360000	TOP1.5GS2/90 7.2STI OR	C.38
0393460000	TOP1.5GS3/90 7.2STI OR	C.38
0393560000	TOP1.5GS4/90 7.2STI OR	C.38
0393660000	TOP1.5GS5/90 7.2STI OR	C.38
0393960000	TOP1.5GS9/90 7.2STI OR	C.38
0394060000	TOP1.5GS11/90 7.2STI OR	C.38
0394160000	TOP1.5GS12/90 7.2STI OR	C.38

## 046000000

0460660001	DEK 5 FSZ 1-10	L.17
0460660001	DEK 5 FSZ 1-10	M.7
0460660011	DEK 5 FSZ 11-20	L.17
0460660011	DEK 5 FSZ 11-20	M.7
0460660091	DEK 5 FSZ 91-100	L.17
0460660091	DEK 5 FSZ 91-100	M.7

## 047000000

0473360000	DEK 5 NEUTRAL	L.17
0473360000	DEK 5 NEUTRAL	J.18
0473360000	DEK 5 NEUTRAL	J.19
0473360000	DEK 5 NEUTRAL	J.20
0473360000	DEK 5 NEUTRAL	J.21
0473360000	DEK 5 NEUTRAL	J.22
0473360000	DEK 5 NEUTRAL	J.24
0473360000	DEK 5 NEUTRAL	M.7
0473460001	DEK 5 FW 1-50	L.17
0473460001	DEK 5 FW 1-50	M.7
0473460051	DEK 5 FW 51-100	L.17
0473460051	DEK 5 FW 51-100	M.7
0473460951	DEK 5 FW 951-999	L.17
0473460951	DEK 5 FW 951-999	M.7
0473560001	DEK 5 FS 1-50	L.17
0473560001	DEK 5 FS 1-50	M.7
0473560051	DEK 5 FS 51-100	L.17
0473560051	DEK 5 FS 51-100	M.7
0473560951	DEK 5 FS 951-999	L.17
0473560951	DEK 5 FS 951-999	M.7

## 048000000

0485200000	ADP 1/HP1 1M	N.46
------------	--------------	------

## 049000000

0490790000	DEK 5 SONDERDRUCK FARB.	L.17
0490790000	DEK 5 SONDERDRUCK FARB.	M.7

## 051000000

05144510000	TS 35X7.5/LL 1M/ST/ZN	N.37
-------------	-----------------------	------

## 052000000

0522361075	DEK 5 GW L1	L.17
0522361075	DEK 5 GW L1	M.7
0522361076	DEK 5 GW L2	L.17
0522361076	DEK 5 GW L2	M.7
0522361077	DEK 5 GW L3	L.17
0522361077	DEK 5 GW L3	M.7
0522660001	DEK 5 GW 1	L.17
0522660001	DEK 5 GW 1	M.7
0522660002	DEK 5 GW 2	L.17
0522660002	DEK 5 GW 2	M.7
0522660200	DEK 5 GW 200	L.17
0522660200	DEK 5 GW 200	M.7
0522761021	DEK 5 GW A	L.17
0522761021	DEK 5 GW A	M.7
0522761022	DEK 5 GW B	L.17
0522761022	DEK 5 GW B	M.7
0522761023	DEK 5 GW C	L.17
0522761023	DEK 5 GW C	M.7
0522761024	DEK 5 GW D	L.17
0522761024	DEK 5 GW D	M.7
0522761025	DEK 5 GW E	L.17
0522761025	DEK 5 GW E	M.7
0522761026	DEK 5 GW F	L.17
0522761026	DEK 5 GW F	M.7
0522761027	DEK 5 GW G	L.17
0522761027	DEK 5 GW G	M.7
0522761028	DEK 5 GW H	L.17
0522761028	DEK 5 GW H	M.7
0522761029	DEK 5 GW I	L.17
0522761029	DEK 5 GW I	M.7
0522761030	DEK 5 GW J	L.17
0522761030	DEK 5 GW J	M.7
0522761031	DEK 5 GW K	L.17
0522761031	DEK 5 GW K	M.7
0522761032	DEK 5 GW L	L.17
0522761032	DEK 5 GW L	M.7
0522761033	DEK 5 GW M	L.17
0522761033	DEK 5 GW M	M.7
0522761034	DEK 5 GW N	L.17
0522761034	DEK 5 GW N	M.7
0522761035	DEK 5 GW O	L.17

Order No.	Type	Page
-----------	------	------

0522761035	DEK 5 GW O	M.7
0522761036	DEK 5 GW P	L.17
0522761036	DEK 5 GW P	M.7
0522761037	DEK 5 GW Q	L.17
0522761037	DEK 5 GW Q	M.7
0522761038	DEK 5 GW R	L.17
0522761038	DEK 5 GW R	M.7
0522761039	DEK 5 GW S	L.17
0522761039	DEK 5 GW S	M.7
0522761040	DEK 5 GW T	L.17
0522761040	DEK 5 GW T	M.7
0522761041	DEK 5 GW U	L.17
0522761041	DEK 5 GW U	M.7
0522761042	DEK 5 GW V	L.17
0522761042	DEK 5 GW V	M.7
0522761043	DEK 5 GW W	L.17
0522761043	DEK 5 GW W	M.7
0522761044	DEK 5 GW X	L.17
0522761044	DEK 5 GW X	M.7
0522761045	DEK 5 GW Y	L.17
0522761045	DEK 5 GW Y	M.7
0522761046	DEK 5 GW Z	L.17
0522761046	DEK 5 GW Z	M.7
0523060001	DEK 5 FWZ 1-10	L.17
0523060001	DEK 5 FWZ 1-10	M.7
0523060011	DEK 5 FWZ 11-20	L.17
0523060011	DEK 5 FWZ 11-20	M.7
0523060091	DEK 5 FWZ 91-100	L.17
0523060091	DEK 5 FWZ 91-100	M.7

## 056000000

0569960000	TOP1.5GS2/180 5.2STI OR	C.37
------------	-------------------------	------

## 057000000

0570160000	TOP1.5GS3/180 5.2STI OR	C.37
0570360000	TOP1.5GS4/180 5.2STI OR	C.37
0570560000	TOP1.5GS10/180 5.2STI OR	C.37
0570760000	TOP1.5GS16/180 5.2STI OR	C.37
0570960000	TOP1.5GS18/180 5.2STI OR	C.39
0571160000	TOP1.5GS10/180 7.2STI OR	C.39
0576261198	DEK 5 GW +	L.17
0576261198	DEK 5 GW +	M.7
0576261199	DEK 5 GW -	L.17
0576261199	DEK 5 GW -	M.7
0576261202	DEK 5 GW ERDE	L.17
0576261202	DEK 5 GW ERDE	M.7
0576261203	DEK 5 GW ERDE I.K.R.	L.17
0576261203	DEK 5 GW ERDE I.K.R.	M.7
0576261215	DEK 5 GW W-STROM	L.17
0576261215	DEK 5 GW W-STROM	M.7

## 059000000

0593860000	TOP1.5GS6/90 5.2STI OR	C.36
0593960000	TOP1.5GS7/90 5.2STI OR	C.36
0594060000	TOP1.5GS8/90 5.2STI OR	C.36
0594160000	TOP1.5GS9/90 5.2STI OR	C.36
0594260000	TOP1.5GS11/90 5.2STI OR	C.36
0594360000	TOP1.5GS12/90 5.2STI OR	C.36
0594460000	TOP1.5GS13/90 5.2STI OR	C.36
0594560000	TOP1.5GS14/90 5.2STI OR	C.36
0594660000	TOP1.5GS15/90 5.2STI OR	C.36
0594760000	TOP1.5GS17/90 5.2STI OR	C.36
0594960000	TOP1.5GS19/90 5.2STI OR	C.36
0595060000	TOP1.5GS20/90 5.2STI OR	C.36
0595160000	TOP1.5GS21/90 5.2STI OR	C.36
0595260000	TOP1.5GS22/90 5.2STI OR	C.36
0595360000	TOP1.5GS23/90 5.2STI OR	C.36
0595460000	TOP1.5GS24/90 5.2STI OR	C.36
0597360000	TOP1.5GS15/180 5.2STI OR	C.37
0597460000	TOP1.5GS16/180 5.2STI OR	C.37
0597660000	TOP1.5GS18/180 5.2STI OR	C.37
0597960000	TOP1.5GS12/180 5.2STI OR	C.37
0598160000	TOP1.5	

Table with columns: Order No., Type, Page. Contains a list of order entries from 1002350000 to 1005410000.

Table with columns: Order No., Type, Page. Contains a list of order entries from 1013720000 to 1020640000.

Table with columns: Order No., Type, Page. Contains a list of order entries from 1020690000 to 1032140000.

Table with columns: Order No., Type, Page. Contains a list of order entries from 1032150000 to 1035630000.

1010000000

1020000000



Order No.	Type	Page
1069680000	SHL-SMT 5.00/02GR 3.2BX	N.19
1069680000	SHL-SMT 5.00/02GR 3.2BX	N.31
1069690000	SHL-SMT 5.00/03GR 5.9BX	N.21
1069690000	SHL-SMT 5.00/03GR 5.9BX	N.31
1069710000	SHL-SMT 5.00/04GR 5.9BX	N.23
1069710000	SHL-SMT 5.00/04GR 5.9BX	N.25
1069710000	SHL-SMT 5.00/04GR 5.9BX	N.27
1069710000	SHL-SMT 5.00/04GR 5.9BX	N.31
1069720000	SHL-SMT 5.00/02GR 3.2RL	N.19
1069720000	SHL-SMT 5.00/02GR 3.2RL	N.21
1069730000	SHL-SMT 5.00/03GR 5.9RL	N.19
1069730000	SHL-SMT 5.00/03GR 5.9RL	N.23
1069740000	SHL-SMT 5.00/04GR 5.9RL	N.23
1069740000	SHL-SMT 5.00/04GR 5.9RL	N.25
1069740000	SHL-SMT 5.00/04GR 5.9RL	N.27
1069740000	SHL-SMT 5.00/04GR 5.9RL	N.31
1069750000	SHL-SMT 5.00/02GL 3.2BX	N.19
1069750000	SHL-SMT 5.00/02GL 3.2BX	N.30
1069760000	SHL-SMT 5.00/03GL 5.9BX	N.30
1069760000	SHL-SMT 5.00/03GL 5.9BX	N.23
1069770000	SHL-SMT 5.00/04GL 5.9BX	N.25
1069770000	SHL-SMT 5.00/04GL 5.9BX	N.27
1069770000	SHL-SMT 5.00/04GL 5.9BX	N.30
1069780000	SHL-SMT 5.00/02GL 3.2RL	N.19
1069780000	SHL-SMT 5.00/02GL 3.2RL	N.30
1069790000	SHL-SMT 5.00/03GL 5.9RL	N.21
1069790000	SHL-SMT 5.00/03GL 5.9RL	N.30
1069810000	SHL-SMT 5.00/04GL 5.9RL	N.23
1069810000	SHL-SMT 5.00/04GL 5.9RL	N.25
1069810000	SHL-SMT 5.00/04GL 5.9RL	N.27
1069810000	SHL-SMT 5.00/04GL 5.9RL	N.30

Order No.	Type	Page
1073410000	CH20M6 C TP 8089	N.17
1073420000	CH20M22 C TP 8089	N.23

### 1080000000

1080320000	BVF 7.62HP/02/180 BCF/06R SN BK BX	K.32
1080440000	BVF 7.62HP/04/180 BCF/06R SN BK BX	K.32
1080490000	BVF 7.62HP/03/180 BCF/04R SN BK BX	K.32
1080510000	BVF 7.62HP/04/180 BCF/04R SN BK BX	K.32
1080550000	BVF 7.62HP/02/180 BCF/04R SN BK BX	K.32
1080570000	BVF 7.62HP/03/180 BCF/06R SN BK BX	K.32
1080630000	CH20M22 S PSC5 BK 2010	N.22
1080720000	BVF 7.62HP/05/180MSF4 BCF/06R SN BK BX	K.37
1080940000	BVF 7.62HP/05/180MSF4 BCF/04R SN BK BX	K.37
1081030000	BVF 7.62HP/02/180M2F BCF/06R SN BK BX	K.34
1081150000	BVF 7.62HP/04/180M4 BCF/04R SN BK BX	K.35
1081610000	BVF 7.62HP/02/180M2F BCF/04R SN BK BX	K.34
1081630000	BVF 7.62HP/03/180M3 BCF/04R SN BK BX	K.35
1081660000	BVF 7.62HP/04/180M4 BCF/04R SN BK BX	K.37
1081720000	BVF 7.62HP/03/180M3 BCF/06R SN BK BX	K.35
1081730000	BVF 7.62HP/03/180M3 BCF/06R SN BK BX	K.37
1081750000	BVF 7.62HP/04/180MSF4 BCF/06R SN BK BX	K.37
1081760000	BVF 7.62HP/05/180M4 BCF/06R SN BK BX	K.35
1081930000	BVF 7.62HP/02/180MSF2 BCF/04R SN BK BX	K.36
1082000000	BVF 7.62HP/04/180M4 BCF/06R SN BK BX	K.35
1082082000	BVF 7.62HP/02/180MSF2 BCF/06R SN BK BX	K.36
1082110000	BVF 7.62HP/03/180MSF3 BCF/04R SN BK BX	K.37
1082140000	BVF 7.62HP/05/180MSF4 BCF/04R SN BK BX	K.35
1082490000	ESG 6.6/11 BHZ 5.00/02	N.19
1082490000	ESG 6.6/11 BHZ 5.00/02	N.33
1082520000	ESG 6.6/15 BHZ 5.00/03	N.21
1082520000	ESG 6.6/15 BHZ 5.00/03	N.33
1082540000	ESG 6.6/20 BHZ 5.00/04	N.23
1082540000	ESG 6.6/20 BHZ 5.00/04	N.25
1082540000	ESG 6.6/20 BHZ 5.00/04	N.27
1082540000	ESG 6.6/20 BHZ 5.00/04	N.33
1082750000	BLZP 5.08HC/02/90LR SN OR BX	6.107
1082760000	BLZP 5.08HC/03/90LR SN OR BX	6.107
1082770000	BLZP 5.08HC/04/90LR SN OR BX	6.107
1082780000	BLZP 5.08HC/05/90LR SN OR BX	6.107
1082790000	BLZP 5.08HC/06/90LR SN OR BX	6.107
1082930000	BLZP 5.08HC/07/90LR SN OR BX	6.107
1082970000	BLZP 5.08HC/08/90LR SN OR BX	6.107
1082970000	BLZP 5.08HC/09/90LR SN OR BX	6.107
1082970000	BLZP 5.08HC/10/90LR SN OR BX	6.107
1082970000	BLZP 5.08HC/11/90LR SN OR BX	6.107
1082970000	BLZP 5.08HC/12/90LR SN OR BX	6.107
1082970000	BLZP 5.08HC/13/90LR SN OR BX	6.107
1082970000	BLZP 5.08HC/14/90LR SN OR BX	6.107
1082970000	BLZP 5.08HC/15/90LR SN OR BX	6.107
1082970000	BLZP 5.08HC/16/90LR SN OR BX	6.107
1082970000	BLZP 5.08HC/17/90LR SN OR BX	6.107
1082970000	BLZP 5.08HC/18/90LR SN OR BX	6.107
1082970000	BLZP 5.08HC/19/90LR SN OR BX	6.107
1082970000	BLZP 5.08HC/20/90LR SN OR BX	6.107
1082970000	BLZP 5.08HC/21/90LR SN OR BX	6.107
1082970000	BLZP 5.08HC/22/90LR SN OR BX	6.107
1082970000	BLZP 5.08HC/23/90LR SN OR BX	6.107
1082970000	BLZP 5.08HC/24/90LR SN OR BX	6.107
1082970000	BLZP 5.08HC/25/90LR SN OR BX	6.107
1089260000	SV 7.62HP/02/270MF2 SC/04R SN BK BX	K.28
1089280000	SV 7.62HP/02/270MF2 SC/06R SN BK BX	K.28
1089340000	SV 7.62HP/02/270MF2 SC/04R SN BK BX	K.28
1089370000	SV 7.62HP/02/90MF2 SC/04R SN BK BX	K.22
1089380000	SV 7.62HP/02/270MF2 SC/06R SN BK BX	K.28

Order No.	Type	Page
1089410000	SV 7.62HP/02/90MF2 SC/06R SN BK BX	K.22
1089440000	SV 7.62HP/03/270MF3 SC/04R SN BK BX	K.29
1089490000	SV 7.62HP/03/270MF3 SC/06R SN BK BX	K.29
1089510000	SV 7.62HP/02/90MF2 SC/04R SN BK BX	K.24
1089570000	SV 7.62HP/02/90MF2 SC/06R SN BK BX	K.24
1089610000	SV 7.62HP/03/270MF3 SC/04R SN BK BX	K.29
1089660000	SV 7.62HP/03/90MF3 SC/04R SN BK BX	K.23
1089670000	SV 7.62HP/03/270MF3 SC/06R SN BK BX	K.23
1089730000	SV 7.62HP/03/90MF3 SC/06R SN BK BX	K.21
1089820000	SV 7.62HP/04/270MF4 SC/04R SN BK BX	K.29
1089840000	SV 7.62HP/02/90G SC/04R SN BK BX	K.20
1089890000	SV 7.62HP/03/90MF3 SC/04R SN BK BX	K.25
1089910000	SV 7.62HP/04/270MF4 SC/06R SN BK BX	K.29
1089920000	SV 7.62HP/02/90G SC/06R SN BK BX	K.20
1089970000	SV 7.62HP/03/90MF3 SC/06R SN BK BX	K.25

### 1090000000

1090040000	SV 7.62HP/03/90G SC/04R SN BK BX	K.20
1090060000	SV 7.62HP/04/270MSF3 SC/04R SN BK BX	K.31
1090120000	SV 7.62HP/03/90G SC/06R SN BK BX	K.20
1090130000	SV 7.62HP/04/90MF4 SC/04R SN BK BX	K.23
1090140000	SV 7.62HP/04/270MSF4 SC/06R SN BK BX	K.31
1090210000	SV 7.62HP/04/90MF4 SC/06R SN BK BX	K.23
1090280000	SV 7.62HP/04/90G SC/04R SN BK BX	K.20
1090300000	SV 7.62HP/05/270MF4 SC/04R SN BK BX	K.29
1090360000	SV 7.62HP/04/90G SC/06R SN BK BX	K.26
1090370000	SV 7.62HP/04/90MSF4 SC/04R SN BK BX	K.25
1090380000	SV 7.62HP/05/270MF4 SC/06R SN BK BX	K.29
1090450000	SV 7.62HP/04/90MSF4 SC/06R SN BK BX	K.25
1090520000	SV 7.62HP/05/90G SC/04R SN BK BX	K.20
1090540000	SV 7.62HP/05/270MSF4 SC/04R SN BK BX	K.31
1090590000	SV 7.62HP/05/90G SC/06R SN BK BX	K.20
1090600000	SV 7.62HP/05/90MF4 SC/04R SN BK BX	K.23
1090610000	SV 7.62HP/05/270MSF4 SC/06R SN BK BX	K.31
1090670000	SV 7.62HP/05/90MF4 SC/06R SN BK BX	K.23
1090700000	SV 7.62HP/02/270G SC/04R SN BK BX	K.26
1090830000	SV 7.62HP/05/90MSF4 SC/04R SN BK BX	K.25
1090850000	SV 7.62HP/02/270G SC/06R SN BK BX	K.26
1090900000	SV 7.62HP/05/90MSF4 SC/06R SN BK BX	K.25
1090950000	SV 7.62HP/03/270G SC/04R SN BK BX	K.26
1091010000	SV 7.62HP/03/270G SC/06R SN BK BX	K.26
1091120000	SV 7.62HP/04/270G SC/04R SN BK BX	K.26
1091160000	SV 7.62HP/04/270G SC/06R SN BK BX	K.26
1091240000	SV 7.62HP/05/270G SC/04R SN BK BX	K.26
1091260000	SV 7.62HP/05/270G SC/06R SN BK BX	K.26
1093430000	BLZ 7.62HP/02/180LR SN BK BX	K.93
1093440000	BLZ 7.62HP/03/180LR SN BK BX	K.93
1093450000	BLZ 7.62HP/04/180LR SN BK BX	K.93
1093460000	BLZ 7.62HP/05/180LR SN BK BX	K.93
1095640000	BLZ 7.62HP/02/90LF 3.2 SN BK BX	K.97
1095650000	BLZ 7.62HP/03/90LF 3.2 SN BK BX	K.97
1095660000	BLZ 7.62HP/04/90LF 3.2 SN BK BX	K.97
1095670000	BLZ 7.62HP/05/90LF 3.2 SN BK BX	K.97
1095920000	SL 7.62HP/02/90LF 3.2 SN BK BX	K.83
1095930000	SL 7.62HP/03/90LF 3.2 SN BK BX	K.83
1095940000	SL 7.62HP/04/90LF 3.2 SN BK BX	K.83
1095950000	SL 7.62HP/05/90LF 3.2 SN BK BX	K.83
1095960000	SL 7.62HP/06/90LF 3.2 SN BK BX	K.83
1095970000	SL 7.62HP/07/90LF 3.2 SN BK BX	K.83
1095980000	SL 7.62HP/08/90LF 3.2 SN BK BX	K.83
1095990000	SL 7.62HP/09/90LF 3.2 SN BK BX	K.83
1096000000	SL 7.62HP/10/90LF 3.2 SN BK BX	K.83
1096010000	SL 7.62HP/11/90LF 3.2 SN BK BX	K.83
1096020000	SL 7.62HP/12/90LF 3.2 SN BK BX	K.83

### 1100000000

1104170000	CH20M12 B BK/BK	N.18
1104180000	CH20M12 B BK/OR	N.18
1104190000	CH20M12 F BK 2010	N.19
1104200000	CH20M12 S PSC5 BK 2010	N.18
1104210000	CH20M12 S PSC5 BK 2010	N.18
1104240000	CH20M12 CBK 1819	N.19
1104250000	CH20M12 C TP 8089	N.19
1104400000	CH20M45 B BK/BK	N.24
1104410000	CH20M45 B BK/OR	N.24
1104420000	CH20M45 FBK 2010	N.25
1104430000	CH20M45 CBK 1819	N.25
1104440000	CH20M45 C TP 8089	N.25
1104450000	CH20M22 B BK/OR	N.22
1105600000	SK DEMO CH20M22	N.22

### 1110000000

1110720000	SL-SMT 5.00HC/08/180G 1.5SN BK RL	6.27
1111630000	SK DEMO CH20M12	N.18
1111640000	SK DEMO CH20M45	N.24
1111720000	CH20M45 S 2PSC/2PSC BK 2010	N.24
1118470000	BVF 7.62HP SH180 4-6 KIT	K.34
1118470000	BVF 7.62HP SH180 4-6 KIT	K.36
1118470000	BVF 7.62HP SH180 4-6 KIT	K.38
1118470000	BVF 7.62HP SH180 4-6 KIT	K.42
1118470000	BVF 7.62HP SH180 4-6 KIT	K.44
1118470000	BVF 7.62HP SH180 4-6 KIT	M.3
1118480000	BVF 7.62HP SH150 4-6 KIT	K.36
1118480000	BVF 7.62HP SH150 4-6 KIT	K.38
1118480000	BVF 7.62HP SH150 4-6 KIT	K.42
1118480000	BVF 7.62HP SH150 4-6 KIT	K.44
1118480000	BVF 7.62HP SH150 4-6 KIT	K.46
1118480000	BVF 7.62HP SH150 4-6 KIT	K.48

Order No.	Type	Page
1118480000	BVF 7.62HP SH150 4-6 KIT	K.44
1118480000	BVF 7.62HP SH150 4-6 KIT	M.3
1118490000	BVF 7.62HP SH210 4-6 KIT	K.34
1118490000	BVF 7.62HP SH210 4-6 KIT	K.36
1118490000	BVF 7.62HP SH210 4-6 KIT	K.38
1118490000	BVF 7.62HP SH210 4-6 KIT	K.42
1118490000	BVF 7.62HP SH210 4-6 KIT	K.44
1118490000	BVF 7.62HP SH210 4-6 KIT	M.3

### 1120000000

1122070000	BLL 7.62HP/02/180 3.2SN BK BX	K.98
1122080000	BLL 7.62HP/03/180 3.2SN BK BX	K.98
1122090000	BLL 7.62HP/04/180 3.2SN BK BX	K.98
1122100000	BLL 7.62HP/05/180 3.2SN BK BX	K.98
1122110000	BLL 7.62HP/02/180F 3.2SN BK BX	K.99
1122120000	BLL 7.62HP/03/180F 3.2SN BK BX	K.99
1122130000	BLL 7.62HP/04/180F 3.2SN BK BX	K.99
1122140000	BLL 7.62HP/05/180F 3.2SN BK BX	K.99
1122550000	SL 7.62HP/02/180G 3.2SN BK BX	K.84
1122570000	SL 7.62HP/03/180G 3.2SN BK BX	K.84
1122580000	SL 7.62HP/04/180G 3.2SN BK BX	K.84
1122590000	SL 7.62HP/07/180G 3.2SN BK BX	K.84
1122600000	SL 7.62HP/09/180G 3.2SN BK BX	K.84
1122610000	SL 7.62HP/10/180G 3.2SN BK BX	K.84
1122640000	SL 7.62HP/11/180G 3.2SN BK BX	K.84
1122650000	SL 7.62HP/12/180G 3.2SN BK BX	K.84
1124250000	SL 7.62HP/06/90F 3.2 SN BK BX	K.83
1124270000	SL 7.62HP/07/90F 3.2 SN BK BX	K.83
1124280000	SL 7.62HP/08/90F 3.2 SN BK BX	K.83
1124290000	SL 7.62HP/09/90F 3.2 SN BK BX	K.83
1124300000	SL 7.62HP/10/90F 3.2 SN BK BX	K.83
1124310000	SL 7.62HP/11/90F 3.2 SN BK BX	K.83
1124320000	SL 7.62HP/12/90F 3.2 SN BK BX	K.83
1124750000	SVF 7.62HP/02/180F1 SN BK BX	K.144
1124760000	SVF 7.62HP/03/180F1 SN BK BX	K.144
1124770000	SVF 7.62HP/04/180F1 SN BK BX	K.144
1124780000	SVF 7.62HP/05/180F1 SN BK BX	K.144
1124810000	SVF 7.62HP/02/180SF1 SN BK BX	K.145
11248		

Table with columns: Order No., Type, Page. Contains multiple rows of product identifiers and page numbers.

Table with columns: Order No., Type, Page. Contains multiple rows of product identifiers and page numbers.

Table with columns: Order No., Type, Page. Contains multiple rows of product identifiers and page numbers.

Table with columns: Order No., Type, Page. Contains multiple rows of product identifiers and page numbers.

115000000

Table with columns: Order No., Type, Page. Contains rows for product identifiers 115000000 through 1154980000.

116000000

Table with columns: Order No., Type, Page. Contains rows for product identifiers 1164630000 through 1168970000.

117000000

Table with columns: Order No., Type, Page. Contains rows for product identifiers 1173490000 through 1177030000.

118000000

Table with columns: Order No., Type, Page. Contains rows for product identifiers 1185060000 through 1189370000.

119000000

Table with columns: Order No., Type, Page. Contains rows for product identifiers 1190600000 through 1193170000.

120000000

Table with columns: Order No., Type, Page. Contains rows for product identifiers 1203290000 through 1221310000.

123000000

Table with columns: Order No., Type, Page. Contains multiple rows of product identifiers and page numbers.

Order No.	Type	Page
1235250000	CH20M67 B BK/OR	N.26
1235270000	CH20M67 B BK/BK	N.26
1235310000	CH20M67 FC BK 2010	N.27
1235320000	CH20M67 S 2PSC/2PSC/2PSC BK 2010	N.26
1235790000	BCF 3.81/05/180ZE SN OR BX	F.56
1235800000	BCF 3.81/06/180ZE SN OR BX	F.56
1235810000	BCF 3.81/07/180ZE SN OR BX	F.56
1235820000	BCF 3.81/08/180ZE SN OR BX	F.56
1235830000	BCF 3.81/09/180ZE SN OR BX	F.56
1235840000	BCF 3.81/10/180ZE SN OR BX	F.56
1235870000	BCF 3.81/11/180ZE SN OR BX	F.56
1235880000	BCF 3.81/12/180ZE SN OR BX	F.56
1235890000	BCF 3.81/13/180ZE SN OR BX	F.56
1235900000	BCF 3.81/14/180ZE SN OR BX	F.56
1235910000	BCF 3.81/15/180ZE SN OR BX	F.56
1235920000	BCF 3.81/16/180ZE SN OR BX	F.56
1235930000	BCF 3.81/17/180ZE SN OR BX	F.56
1235940000	BCF 3.81/18/180ZE SN OR BX	F.56
1235970000	BCF 3.81/05/180FZE SN OR BX	F.57
1235980000	BCF 3.81/06/180FZE SN OR BX	F.57
1235990000	BCF 3.81/07/180FZE SN OR BX	F.57
1236000000	BCF 3.81/08/180FZE SN OR BX	F.57
1236010000	BCF 3.81/09/180FZE SN OR BX	F.57
1236020000	BCF 3.81/10/180FZE SN OR BX	F.57
1236030000	BCF 3.81/11/180FZE SN OR BX	F.57
1236040000	BCF 3.81/12/180FZE SN OR BX	F.57
1236050000	BCF 3.81/13/180FZE SN OR BX	F.57
1236070000	BCF 3.81/14/180FZE SN OR BX	F.57
1236080000	BCF 3.81/15/180FZE SN OR BX	F.57
1236090000	BCF 3.81/16/180FZE SN OR BX	F.57
1236100000	BCF 3.81/17/180FZE SN OR BX	F.57
1236110000	BCF 3.81/18/180FZE SN OR BX	F.57
1236270000	BCZ 3.81/05/180ZE SN OR BX	F.50
1236280000	BCZ 3.81/06/180ZE SN OR BX	F.50
1236290000	BCZ 3.81/07/180ZE SN OR BX	F.50
1236300000	BCZ 3.81/08/180ZE SN OR BX	F.50
1236320000	BCZ 3.81/09/180ZE SN OR BX	F.50
1236330000	BCZ 3.81/10/180ZE SN OR BX	F.50
1236340000	BCZ 3.81/11/180ZE SN OR BX	F.50
1236370000	BCZ 3.81/12/180ZE SN OR BX	F.50
1236380000	BCZ 3.81/13/180ZE SN OR BX	F.50
1236390000	BCZ 3.81/14/180ZE SN OR BX	F.50
1236400000	BCZ 3.81/15/180ZE SN OR BX	F.50
1236410000	BCZ 3.81/16/180ZE SN OR BX	F.50
1236420000	BCZ 3.81/17/180ZE SN OR BX	F.50
1236430000	BCZ 3.81/18/180ZE SN OR BX	F.50
1236440000	BCZ 3.81/19/180ZE SN OR BX	F.50
1236470000	BCZ 3.81/20/180ZE SN OR BX	F.50
1236530000	BCZ 3.81/05/180FZE SN OR BX	F.51
1236540000	BCZ 3.81/06/180FZE SN OR BX	F.51
1236570000	BCZ 3.81/07/180FZE SN OR BX	F.51
1236590000	BCZ 3.81/08/180FZE SN OR BX	F.51
1236600000	BCZ 3.81/09/180FZE SN OR BX	F.51
1236610000	BCZ 3.81/10/180FZE SN OR BX	F.51
1236620000	BCZ 3.81/11/180FZE SN OR BX	F.51
1236630000	BCZ 3.81/12/180FZE SN OR BX	F.51
1236640000	BCZ 3.81/13/180FZE SN OR BX	F.51
1236670000	BCZ 3.81/14/180FZE SN OR BX	F.51
1236680000	BCZ 3.81/15/180FZE SN OR BX	F.51
1236690000	BCZ 3.81/16/180FZE SN OR BX	F.51
1236700000	BCZ 3.81/17/180FZE SN OR BX	F.51
1236720000	BCZ 3.81/18/180FZE SN OR BX	F.51
1236730000	BCZ 3.81/19/180FZE SN OR BX	F.51
1236740000	BCZ 3.81/20/180FZE SN OR BX	F.51
1237000000	SC2 3.81/04/180GZE SN OR BX	F.46
1237010000	SC2 3.81/05/180GZE SN OR BX	F.46
1237020000	SC2 3.81/06/180GZE SN OR BX	F.46
1237030000	SC2 3.81/07/180GZE SN OR BX	F.46
1237040000	SC2 3.81/08/180GZE SN OR BX	F.46
1237070000	SC2 3.81/09/180GZE SN OR BX	F.46
1237080000	SC2 3.81/10/180GZE SN OR BX	F.46
1237090000	SC2 3.81/11/180GZE SN OR BX	F.46
1237100000	SC2 3.81/12/180GZE SN OR BX	F.46
1237120000	SC2 3.81/04/180FZE SN OR BX	F.47
1237130000	SC2 3.81/05/180FZE SN OR BX	F.47
1237140000	SC2 3.81/06/180FZE SN OR BX	F.47
1237170000	SC2 3.81/07/180FZE SN OR BX	F.47
1237180000	SC2 3.81/08/180FZE SN OR BX	F.47
1237190000	SC2 3.81/09/180FZE SN OR BX	F.47
1237200000	SC2 3.81/10/180FZE SN OR BX	F.47
1237210000	SC2 3.81/11/180FZE SN OR BX	F.47
1237220000	SC2 3.81/12/180FZE SN OR BX	F.47
1237550000	SCZ 3.81/04/180FZE SN OR BX	F.47
1237560000	SCZ 3.81/05/180FZE SN OR BX	F.47
1237570000	SCZ 3.81/06/180FZE SN OR BX	F.47
1237580000	SCZ 3.81/07/180FZE SN OR BX	F.47
1237590000	SCZ 3.81/08/180FZE SN OR BX	F.47
1237610000	SCZ 3.81/09/180FZE SN OR BX	F.47
1237620000	SCZ 3.81/10/180FZE SN OR BX	F.47
1237630000	SCZ 3.81/11/180FZE SN OR BX	F.47
1237640000	SCZ 3.81/12/180FZE SN OR BX	F.47
1238340000	DEK 5/5 MC NE OR	L.17
1238340000	DEK 5/5 MC NE OR	M.7

## 1240000000

1247240000	CH20M67 B BUS BK/OR	N.26
1247250000	CH20M67 B FE BK/OR	N.26
1248150000	CH20M BUS-PROFIL TS 35X75/250	N.36

Order No.	Type	Page
1248160000	CH20M BUS-PROFIL TS 35X75/500	N.36
1248170000	CH20M BUS-PROFIL TS 35X75/750	N.36
1248180000	CH20M BUS-PROFIL TS 35X15/250	N.36
1248190000	CH20M BUS-PROFIL TS 35X15/500	N.36
1248210000	CH20M BUS-PROFIL TS 35X15/750	N.36
1248220000	CH20M BUS 4.50/05 AU/250	N.36
1248230000	CH20M BUS 4.50/05 AU/500	N.36
1248240000	CH20M BUS 4.50/05 AU/750	N.36
1248250000	CH20M BUS-ADP TS 35/250	N.36
1248260000	CH20M BUS-ADP TS 35/500	N.36
1248270000	CH20M BUS-ADP TS 35/750	N.36
1249860000	DEK 5/5 MC NE VI	L.17
1249860000	DEK 5/5 MC NE VI	M.7

## 1250000000

1250360000	LSF-SMD 3.50/02/180 SN BK RL	C.85
1250370000	LSF-SMD 3.50/03/180 SN BK RL	C.85
1250380000	LSF-SMD 3.50/04/180 SN BK RL	C.85
1250390000	LSF-SMD 3.50/05/180 SN BK RL	C.85
1250410000	LSF-SMD 3.50/06/180 SN BK RL	C.85
1250420000	LSF-SMD 3.50/07/180 SN BK RL	C.85
1250430000	LSF-SMD 3.50/08/180 SN BK RL	C.85
1250440000	LSF-SMD 3.50/09/180 SN BK RL	C.85
1250450000	LSF-SMD 3.50/10/180 SN BK RL	C.85
1250460000	LSF-SMD 3.50/11/180 SN BK RL	C.85
1250470000	LSF-SMD 3.50/12/180 SN BK RL	C.85
1250580000	DP WGK 16 BK BX	L.11
1250590000	DP WGK 25 BK BX	L.20
1250610000	DP WGK 50 BK BX	L.22
1250620000	DP WGK 95 BK BX	L.24
1250630000	DP VWG 6 BK BX	L.14
1250640000	DP VWG 6 BK BX	L.16
1250650000	VGW 4 BK BX	L.13
1250660000	VGW 95F VP BK BX	L.25
1250670000	VGW 95F VP2 BK BX	L.25
1250680000	VGW 95 BK BX	L.24
1250690000	VGW 95Z BK BX	L.24
1250930000	VGW 4 BK BX	L.12
1250940000	VGW 4Z BK BX	L.12
1250950000	VGW 4 BK BX	L.13
1250960000	VGW 4Z BK BX	L.13
1251030000	DP WGK 4 BK BX	L.12
1251330000	LL 5.00/13/90 3.2SN OR BX	C.28
1251340000	LL 5.00/15/90 3.2SN OR BX	C.28
1251350000	LL 5.00/17/90 3.2SN OR BX	C.28
1251360000	LL 5.00/18/90 3.2SN OR BX	C.28
1251370000	LL 5.00/19/90 3.2SN OR BX	C.28
1251380000	LL 5.00/20/90 3.2SN OR BX	C.28
1251390000	LL 5.00/21/90 3.2SN OR BX	C.28
1251410000	LL 5.00/22/90 3.2SN OR BX	C.28
1251420000	LL 5.00/23/90 3.2SN OR BX	C.28
1254110000	CH20M AD SHL 5.00/03 BK 2010	N.21
1254120000	CH20M17 B BK/OR	N.20
1254130000	CH20M17 B BK/OR	N.20
1254140000	CH20M17 F BK 2010	N.21
1254150000	CH20M17 C BK 1819	N.21
1254160000	CH20M17 C TP 8089	N.21
1254170000	CH20M17 S PPP BK 2010	N.20
1254180000	CH20M17 B BUS BK/OR	N.20
1254190000	CH20M17 B FE BK/OR	N.20
1255820000	SK S-KIT CH20M17	N.20

## 1260000000

1264240000	CH20M FE 12-67 3.2SN RL	N.35
------------	-------------------------	------

## 1270000000

1275810000	SK S-KIT CH20M67	N.26
1277270000	B2CF 3.50/04/180 SN OR BX	E.12
1277280000	B2CF 3.50/06/180 SN OR BX	E.12
1277290000	B2CF 3.50/08/180 SN OR BX	E.12
1277310000	B2CF 3.50/10/180 SN OR BX	E.12
1277320000	B2CF 3.50/12/180 SN OR BX	E.12
1277330000	B2CF 3.50/14/180 SN OR BX	E.12
1277340000	B2CF 3.50/16/180 SN OR BX	E.12
1277350000	B2CF 3.50/18/180 SN OR BX	E.12
1277360000	B2CF 3.50/20/180 SN OR BX	E.12
1277370000	B2CF 3.50/22/180 SN OR BX	E.12
1277380000	B2CF 3.50/24/180 SN OR BX	E.12
1277390000	B2CF 3.50/26/180 SN OR BX	E.12
1277410000	B2CF 3.50/28/180 SN OR BX	E.12
1277420000	B2CF 3.50/30/180 SN OR BX	E.12
1277430000	B2CF 3.50/32/180 SN OR BX	E.12
1277440000	B2CF 3.50/34/180 SN OR BX	E.12
1277450000	B2CF 3.50/36/180 SN OR BX	E.12
1277460000	B2CF 3.50/04/180F SN OR BX	E.13
1277470000	B2CF 3.50/06/180F SN OR BX	E.13
1277480000	B2CF 3.50/08/180F SN OR BX	E.13
1277490000	B2CF 3.50/10/180F SN OR BX	E.13
1277500000	B2CF 3.50/12/180F SN OR BX	E.13
1277510000	B2CF 3.50/14/180F SN OR BX	E.13
1277520000	B2CF 3.50/16/180F SN OR BX	E.13
1277530000	B2CF 3.50/18/180F SN OR BX	E.13
1277540000	B2CF 3.50/20/180F SN OR BX	E.13
1277550000	B2CF 3.50/22/180F SN OR BX	E.13
1277560000	B2CF 3.50/24/180F SN OR BX	E.13
1277570000	B2CF 3.50/26/180F SN OR BX	E.13
1277580000	B2CF 3.50/28/180F SN OR BX	E.13
1277590000	B2CF 3.50/30/180F SN OR BX	E.13

Order No.	Type	Page
1277810000	B2CF 3.50/28/180F SN OR BX	E.13
1277820000	B2CF 3.50/30/180F SN OR BX	E.13
1277830000	B2CF 3.50/32/180F SN OR BX	E.13
1277840000	B2CF 3.50/34/180F SN OR BX	E.13
1277850000	B2CF 3.50/36/180F SN OR BX	E.13
1278040000	B2CF 3.50/04/180LR SN OR BX	E.13
1278050000	B2CF 3.50/06/180LR SN OR BX	E.13
1278060000	B2CF 3.50/08/180LR SN OR BX	E.13
1278070000	B2CF 3.50/10/180LR SN OR BX	E.13
1278080000	B2CF 3.50/12/180LR SN OR BX	E.13
1278090000	B2CF 3.50/14/180LR SN OR BX	E.13
1278100000	B2CF 3.50/16/180LR SN OR BX	E.13
1278110000	B2CF 3.50/18/180LR SN OR BX	E.13
1278120000	B2CF 3.50/20/180LR SN OR BX	E.13
1278130000	B2CF 3.50/22/180LR SN OR BX	E.13
1278140000	B2CF 3.50/24/180LR SN OR BX	E.13
1278150000	B2CF 3.50/26/180LR SN OR BX	E.13
1278170000	B2CF 3.50/28/180LR SN OR BX	E.13
1278180000	B2CF 3.50/30/180LR SN OR BX	E.13
1278190000	B2CF 3.50/32/180LR SN OR BX	E.13
1278200000	B2CF 3.50/34/180LR SN OR BX	E.13
1278210000	B2CF 3.50/36/180LR SN OR BX	E.13

## 1280000000

1288470000	PGK 4 BK	L.10
1288590000	PGK 4 BT BK	L.11
1288600000	EPL PGK4 BK	L.11
1288610000	VREL PGK4 OR VPE 30	L.10
1288980000	S2C-SMT 3.50/04/90G 3.2SN BK BX	E.6
1289000000	BUL 10.16HP/02/180 4.5AG BK BX SD	K.202
1289010000	BUL 10.16HP/04/180 4.5AG BK BX SD	K.202
1289270000	S2C-SMT 3.50/06/90G 3.2SN BK BX	E.6
1289280000	S2C-SMT 3.50/08/90G 3.2SN BK BX	E.6
1289290000	S2C-SMT 3.50/10/90G 3.2SN BK BX	E.6
1289300000	S2C-SMT 3.50/12/90G 3.2SN BK BX	E.6
1289310000	S2C-SMT 3.50/14/90G 3.2SN BK BX	E.6
1289320000	S2C-SMT 3.50/16/90G 3.2SN BK BX	E.6
1289330000	S2C-SMT 3.50/18/90G 3.2SN BK BX	E.6
1289340000	S2C-SMT 3.50/20/90G 3.2SN BK BX	E.6
1289350000	S2C-SMT 3.50/22/90G 3.2SN BK BX	E.6
1289370000	S2C-SMT 3.50/24/90G 3.2SN BK BX	E.6
1289380000	S2C-SMT 3.50/26/90G 3.2SN BK BX	E.6
1289390000	S2C-SMT 3.50/28/90G 3.2SN BK BX	E.6
1289410000	S2C-SMT 3.50/30/90G 3.2SN BK BX	E.6
1289420000	S2C-SMT 3.50/32/90G 3.2SN BK BX	E.6
1289430000	S2C-SMT 3.50/34/90G 3.2SN BK BX	E.6
1289440000	S2C-SMT 3.50/36/90G 3.2SN BK BX	E.6
1289450000	S2C-SMT 3.50/04/90LF 3.2SN BK BX	E.7
1289460000	S2C-SMT 3.50/06/90LF 3.2SN BK BX	E.7
1289470000	S2C	





Order No.	Type	Page
1426800000	CB1,6R18-16 AU,75,12,5	H.16
1426900000	CB1,6E18-16 AU,75,12,5	H.16
1427220000	SVF 7.62HP/02/180SFM2 SN BK BX	K.150
1427230000	SVF 7.62HP/03/180SFM2 SN BK BX	K.150
1427240000	SVF 7.62HP/03/180SFM3 SN BK BX	K.151
1427250000	SVF 7.62HP/04/180SFM2 SN BK BX	K.150
1427260000	SVF 7.62HP/04/180SFM3 SN BK BX	K.151
1427270000	SVF 7.62HP/04/180SFM4 SN BK BX	K.151
1427500000	CS1,6R18-16 SN,12,5	H.16
1427600000	CS1,6E18-16 SN,12,5	H.16
1427700000	CSL1,6E18-16 SN,12,5	H.16
1427800000	CB1,6R18-16 SN,12,5	H.16
1427900000	CB1,6E18-16 SN,12,5	H.16
1428500000	CS1,6R14-12 AU,75,13,5	H.16
1428600000	CS1,6E14-12 AU,75,13,5	H.16
1428700000	CSL1,6E14-12 AU,75,13,5	H.16
1428800000	CB1,6R14-12 AU,75,13,5	H.16
1428900000	CB1,6E14-12 AU,75,13,5	H.16
1429500000	CS1,6R14-12 SN,13,5	H.16
1429600000	CS1,6E14-12 SN,13,5	H.16
1429700000	CSL1,6E14-12 SN,13,5	H.16
1429800000	CB1,6R14-12 SN,13,5	H.16
1429900000	CB1,6E14-12 SN,13,5	H.16
1429920000	SVF 7.62HP/02/180SFBMF2 SN BK BX	K.152
1429930000	SVF 7.62HP/03/180SFBMF2 SN BK BX	K.152
1429940000	SVF 7.62HP/03/180SFBMF3 SN BK BX	K.153
1429950000	SVF 7.62HP/04/180SFBMF2 SN BK BX	K.152
1429960000	SVF 7.62HP/04/180SFBMF3 SN BK BX	K.153
1429970000	SVF 7.62HP/04/180SFBMF4 SN BK BX	K.153

## 1430000000

1430010000	SVF 7.62HP/04/180MF2 SN BK BX	K.146
1430020000	SVF 7.62HP/05/180MF2 SN BK BX	K.146
1430030000	SVF 7.62HP/04/180MF4 SN BK BX	K.147
1430060000	SVF 7.62HP/04/180MF2 SN BK BX	K.148
1430070000	SVF 7.62HP/05/180MF2 SN BK BX	K.148
1430080000	SVF 7.62HP/04/180MF4 SN BK BX	K.149
1430090000	BVF 7.62HP/04/180MF2 SN BK BX	K.168
1430100000	BVF 7.62HP/05/180MF2 SN BK BX	K.168
1430110000	BVF 7.62HP/04/180MF4 SN BK BX	K.169
1430120000	BVF 7.62HP/04/180MF2 SN BK BX	K.166
1430130000	BVF 7.62HP/05/180MF2 SN BK BX	K.166
1430140000	BVF 7.62HP/04/180MF4 SN BK BX	K.167
1433800000	RJ45C3 T1D 3.2N4N TY	B.20
1433810000	RJ45C3 T1V 3.2N4N TY	B.19
1433890000	RJ45C3 S1D 2.7N4N RL	B.9
1433900000	RJ45C3 S1V 2.7N4N RL	B.6
1433910000	RJ45C8 T1U 2.7N4N TY	B.22
1433920000	RJ45C8 T1V 3.2N4N TY	B.18

## 1440000000

1440200000	RSV1,6 LB4 GR 3,2 AU	H.12
1440300000	RSV1,6 LB4 GR 3,2 SN	H.8
1440400000	RSV1,6 LS4 GR 3,2 AU	H.10
1440500000	RSV1,6 LS4 GR 3,2 SN	H.6
1440600000	RSV1,6 LBF4 GR 3,2 AU	H.13
1440700000	RSV1,6 LBF4 GR 3,2 SN	H.9
1440800000	RSV1,6 LSF4 GR 3,2 AU	H.11
1440850000	SVF/BVF 7.62HP COUPLE SET	K.150
1440850000	SVF/BVF 7.62HP COUPLE SET	K.152
1440850000	SVF/BVF 7.62HP COUPLE SET	K.170
1440850000	SVF/BVF 7.62HP COUPLE SET	K.172
1440900000	RSV1,6 LSF4 GR 3,2 SN	H.7
1441200000	RSV1,6 LBF6 GR 3,2 AU	H.12
1441300000	RSV1,6 LBF6 GR 3,2 SN	H.8
1441400000	RSV1,6 LBF6 GR 3,2 AU	H.10
1441500000	RSV1,6 LSF6 GR 3,2 SN	H.6
1441600000	RSV1,6 LBF6 GR 3,2 AU	H.13
1441700000	RSV1,6 LBF6 GR 3,2 SN	H.9
1441800000	RSV1,6 LSF6 GR 3,2 AU	H.11
1441900000	RSV1,6 LSF6 GR 3,2 SN	H.7
1442200000	RSV1,6 LB9 GR 3,2 AU	H.12
1442300000	RSV1,6 LB9 GR 3,2 SN	H.8
1442400000	RSV1,6 LSF9 GR 3,2 AU	H.10
1442500000	RSV1,6 LSF9 GR 3,2 SN	H.6
1442600000	RSV1,6 LBF9 GR 3,2 AU	H.13
1442700000	RSV1,6 LBF9 GR 3,2 SN	H.9
1442800000	RSV1,6 LSF9 GR 3,2 AU	H.11
1442900000	RSV1,6 LSF9 GR 3,2 SN	H.7
1443200000	RSV1,6 LB12 GR 3,2 AU	H.12
1443300000	RSV1,6 LB12 GR 3,2 SN	H.8
1443400000	RSV1,6 LS12 GR 3,2 AU	H.10
1443500000	RSV1,6 LS12 GR 3,2 SN	H.6
1443600000	RSV1,6 LBF12 GR 3,2 AU	H.13
1443700000	RSV1,6 LBF12 GR 3,2 SN	H.9
1443800000	RSV1,6 LSF12 GR 3,2 AU	H.11
1443900000	RSV1,6 LSF12 GR 3,2 SN	H.7
1444200000	RSV1,6 LB18 GR 3,2 AU	H.12
1444300000	RSV1,6 LB18 GR 3,2 SN	H.8
1444400000	RSV1,6 LS18 GR 3,2 AU	H.10
1444500000	RSV1,6 LS18 GR 3,2 SN	H.6
1444600000	RSV1,6 LBF18 GR 3,2 AU	H.13
1444700000	RSV1,6 LBF18 GR 3,2 SN	H.9
1444800000	RSV1,6 LSF18 GR 3,2 AU	H.11
1444900000	RSV1,6 LSF18 GR 3,2 SN	H.7
1445200000	RSV1,6 LB24 GR 3,2 AU	H.12
1445300000	RSV1,6 LB24 GR 3,2 SN	H.8

Order No.	Type	Page
1445400000	RSV1,6 LS24 GR 3,2 AU	H.10
1445500000	RSV1,6 LS24 GR 3,2 SN	H.6
1445600000	RSV1,6 LBF24 GR 3,2 AU	H.13
1445700000	RSV1,6 LBF24 GR 3,2 SN	H.9
1445800000	RSV1,6 LSF24 GR 3,2 AU	H.11
1445900000	RSV1,6 LSF24 GR 3,2 SN	H.7
1446060000	SLA BB8 RH DR	G.98
1446060000	SLA BB8 RH DR	G.99
1446200000	RSV1,6 LB36 GR 3,2 AU	H.12
1446300000	RSV1,6 LB36 GR 3,2 SN	H.8
1446400000	RSV1,6 LB36 GR 3,2 AU	H.10
1446500000	RSV1,6 LB36 GR 3,2 SN	H.6
1446600000	RSV1,6 LBF36 GR 3,2 AU	H.13
1446700000	RSV1,6 LBF36 GR 3,2 SN	H.9
1446800000	RSV1,6 LSF36 GR 3,2 AU	H.11
1446900000	RSV1,6 LSF36 GR 3,2 SN	H.7

## 1450000000

1455220000	RJ45C3 S1U 0.9N4N RL	B.10
1455240000	RJ45C3 T1U 2.8N4N TY	B.23
1457550000	DEK 5/5 MC NE SW	M.17
1457550000	DEK 5/5 MC NE SW	M.17

## 1460000000

1464270000	SV 7.62HP/04/90MF2 3.5SN BK BX	K.120
1464280000	SV 7.62HP/05/90MF2 3.5SN BK BX	K.120
1464290000	SV 7.62HP/04/90MF4 3.5SN BK BX	K.121
1464310000	SV 7.62HP/04/180MF2 3.5SN BK BX	K.124
1464320000	SV 7.62HP/05/180MF2 3.5SN BK BX	K.124
1464330000	SV 7.62HP/04/180MF4 3.5SN BK BX	K.125
1464340000	SV 7.62HP/04/270MF2 3.5SN BK BX	K.128
1464350000	SV 7.62HP/05/270MF2 3.5SN BK BX	K.128
1464360000	SV 7.62HP/04/270MF4 3.5SN BK BX	K.129

## 1470000000

1472200000	LPA OB 2	I.15
1472240000	SL 7.62HP/02/270G 3.2SN BK BX	K.86
1472250000	SL 7.62HP/03/270G 3.2SN BK BX	K.86
1472260000	SL 7.62HP/04/270G 3.2SN BK BX	K.86
1472270000	SL 7.62HP/05/270G 3.2SN BK BX	K.86
1472280000	SL 7.62HP/06/270G 3.2SN BK BX	K.86
1472290000	SL 7.62HP/07/270G 3.2SN BK BX	K.86
1472300000	LPA OB 3	I.15
1472310000	SL 7.62HP/08/270G 3.2SN BK BX	K.86
1472320000	SL 7.62HP/09/270G 3.2SN BK BX	K.86
1472330000	SL 7.62HP/10/270G 3.2SN BK BX	K.86
1472340000	SL 7.62HP/11/270G 3.2SN BK BX	K.86
1472350000	SL 7.62HP/12/270G 3.2SN BK BX	K.86
1472360000	SL 7.62HP/02/270LF 3.2SN BK BX	K.87
1472370000	SL 7.62HP/03/270LF 3.2SN BK BX	K.87
1472380000	SL 7.62HP/04/270LF 3.2SN BK BX	K.87
1472390000	SL 7.62HP/05/270LF 3.2SN BK BX	K.87
1472400000	LPA OB 4	I.15
1472410000	SL 7.62HP/06/270LF 3.2SN BK BX	K.87
1472420000	SL 7.62HP/07/270LF 3.2SN BK BX	K.87
1472430000	SL 7.62HP/08/270LF 3.2SN BK BX	K.87
1472440000	SL 7.62HP/09/270LF 3.2SN BK BX	K.87
1472450000	SL 7.62HP/10/270LF 3.2SN BK BX	K.87
1472460000	SL 7.62HP/11/270LF 3.2SN BK BX	K.87
1472470000	SL 7.62HP/12/270LF 3.2SN BK BX	K.87
1472500000	LPA OB 10	I.15
1472600000	LPA OB 24	I.15
1473110000	LSF-SMD 3.50/02/135 SN BK RL	C.85
1473200000	LSF-SMD 3.50/03/135 SN BK RL	C.85
1473300000	LSF-SMD 3.50/04/135 SN BK RL	C.85
1473340000	LSF-SMD 3.50/05/135 SN BK RL	C.85
1473350000	LSF-SMD 3.50/06/135 SN BK RL	C.85
1473370000	LSF-SMD 3.50/07/135 SN BK RL	C.85
1473380000	LSF-SMD 3.50/08/135 SN BK RL	C.85
1473390000	LSF-SMD 3.50/09/135 SN BK RL	C.85
1473410000	LSF-SMD 3.50/10/135 SN BK RL	C.85
1473420000	LSF-SMD 3.50/11/135 SN BK RL	C.85
1473430000	LSF-SMD 3.50/12/135 SN BK RL	C.85
1473510000	LSF-SMD 3.50/04/90 SN BK RL	C.84
1473520000	LSF-SMD 3.50/05/90 SN BK RL	C.84
1473530000	LSF-SMD 3.50/06/90 SN BK RL	C.84
1473540000	LSF-SMD 3.50/07/90 SN BK RL	C.84
1473550000	LSF-SMD 3.50/08/90 SN BK RL	C.84
1473560000	LSF-SMD 3.50/09/90 SN BK RL	C.84
1473570000	LSF-SMD 3.50/10/90 SN BK RL	C.84
1473580000	LSF-SMD 3.50/11/90 SN BK RL	C.84
1473590000	LSF-SMD 3.50/12/90 SN BK RL	C.84
1473600000	LSF-SMD 3.50/02/180 SN BK RL	C.87
1473610000	LSF-SMD 3.50/03/180 SN BK RL	C.87
1473620000	LSF-SMD 3.50/04/180 SN BK RL	C.87
1473630000	LSF-SMD 3.50/05/180 SN BK RL	C.87
1473640000	LSF-SMD 3.50/06/180 SN BK RL	C.87
1473650000	LSF-SMD 3.50/07/180 SN BK RL	C.87
1473660000	LSF-SMD 3.50/08/180 SN BK RL	C.87
1473670000	LSF-SMD 3.50/09/180 SN BK RL	C.87
1473680000	LSF-SMD 3.50/10/180 SN BK RL	C.87
1473690000	LSF-SMD 3.50/11/180 SN BK RL	C.87
1473700000	LSF-SMD 3.50/12/180 SN BK RL	C.87
1473710000	LSF-SMD 3.50/02/135 SN BK RL	C.85
1473720000	LSF-SMD 3.50/03/135 SN BK RL	C.85
1473730000	LSF-SMD 3.50/04/135 SN BK RL	C.85
1473740000	LSF-SMD 3.50/05/135 SN BK RL	C.85
1473750000	LSF-SMD 3.50/06/135 SN BK RL	C.85
1473760000	LSF-SMD 3.50/07/135 SN BK RL	C.85

Order No.	Type	Page
1473770000	LSF-SMD 5.00/02/90 SN BK RL	C.86
1473780000	LSF-SMD 5.00/03/90 SN BK RL	C.86
1473790000	LSF-SMD 5.00/04/90 SN BK RL	C.86
1473800000	LSF-SMD 5.00/05/90 SN BK RL	C.86
1473810000	LSF-SMD 5.00/06/90 SN BK RL	C.86
1473820000	LSF-SMD 5.00/07/90 SN BK RL	C.86
1473830000	LSF-SMD 5.00/08/90 SN BK RL	C.86
1473840000	LSF-SMD 7.50/02/180 SN BK RL	C.89
1473850000	LSF-SMD 7.50/03/180 SN BK RL	C.89
1473860000	LSF-SMD 7.50/04/180 SN BK RL	C.89
1473870000	LSF-SMD 7.50/05/180 SN BK RL	C.89
1473880000	LSF-SMD 7.50/06/180 SN BK RL	C.89
1473890000	LSF-SMD 7.50/07/135 SN BK RL	C.89
1473900000	LSF-SMD 7.50/03/135 SN BK RL	C.89
1473910000	LSF-SMD 7.50/04/135 SN BK RL	C.89
1473920000	LSF-SMD 7.50/05/135 SN BK RL	C.89
1473930000	LSF-SMD 7.50/06/135 SN BK RL	C.89
1473940000	LSF-SMD 7.50/02/90 SN BK RL	C.88
1473950000	LSF-SMD 7.50/03/90 SN BK RL	C.88
1473960000	LSF-SMD 7.50/04/90 SN BK RL	C.88
1473970000	LSF-SMD 7.50/05/90 SN BK RL	C.88
1473980000	LSF-SMD 7.50/06/90 SN BK RL	C.88
1474660000	TOP1.5G5S/180 5.2STI OR	C.37
1474760000	TOP1.5G5S/11/180 5.2STI OR	C.37

## 1480000000

1480000000	DFFC 0.5-1.0 SN 3000	G.132
1480100000	DFFC 1.5-2.5 SN 2500	G.132

## 1490000000

1490460000	TOP1.5G5S/180 7.2STI OR	C.39
1494560000	TOP4G6S/180 7.62 OR	C.43
1495060000	LPA SI STI3.2 OR	I.13
1495460000	LPA TR STI3.2 OR	I.13
1495960000	LPA FA2	I.14
1496060000	LPA FA3	I.14
1496160000	LPA FA2 BZ	I.14
1496260000	LPA FA3 BZ	I.14
1497260000	LPA B22	I.14
1497360000	LPA B23	I.14
1499560000	BLT 5.08HC/02/180 SN OR BX	G.112
1499660000	BLT 5.08HC/03/180 SN OR BX	G.112
1499760000	BLT 5.08HC/04/180 SN OR BX	G.112
1499860000	BLT 5.08HC/05/180 SN OR BX	G.112
1499960000	BLT 5.08HC/06/180 SN OR BX	G.112

## 1500000000







Order No.	Type	Page
1649010000	BLL 5.08/24/180 3.2 SN DR BX	G.136
1649370000	BLC 5.08/02/180BR DR BX	G.133
1649380000	BLC 5.08/03/180BR DR BX	G.133
1649390000	BLC 5.08/04/180BR DR BX	G.133
1649400000	BLC 5.08/05/180BR DR BX	G.133
1649410000	BLC 5.08/06/180BR DR BX	G.133
1649420000	BLC 5.08/07/180BR DR BX	G.133
1649430000	BLC 5.08/08/180BR DR BX	G.133
1649440000	BLC 5.08/09/180BR DR BX	G.133
1649450000	BLC 5.08/10/180BR DR BX	G.133
1649460000	BLC 5.08/11/180BR DR BX	G.133
1649470000	BLC 5.08/12/180BR DR BX	G.133
1649480000	BLC 5.08/13/180BR DR BX	G.133
1649490000	BLC 5.08/14/180BR DR BX	G.133
1649500000	BLC 5.08/15/180BR DR BX	G.133
1649510000	BLC 5.08/16/180BR DR BX	G.133

## 1650000000

1650300000	TOP4G53/90 6.35 DR	C.40
1651740000	BLDT 5.08/02/-B SN DR BX	G.123
1651750000	BLDT 5.08/03/-B SN DR BX	G.123
1651760000	BLDT 5.08/04/-B SN DR BX	G.123
1651770000	BLDT 5.08/05/-B SN DR BX	G.123
1651780000	BLDT 5.08/06/-B SN DR BX	G.123
1651790000	BLDT 5.08/07/-B SN DR BX	G.123
1651800000	BLDT 5.08/08/-B SN DR BX	G.123
1651810000	BLDT 5.08/09/-B SN DR BX	G.123
1651820000	BLDT 5.08/10/-B SN DR BX	G.123
1651830000	BLDT 5.08/11/-B SN DR BX	G.123
1651840000	BLDT 5.08/12/-B SN DR BX	G.123
1652040000	BLZ 5.08 2E08 DR BX	G.40
1652040000	BLZ 5.08 2E08 DR BX	L.2
1652050000	BLZ 5.08 2E08 DR BX	G.86
1652050000	BLZ 5.08 2E08 DR BX	G.96
1652050000	BLZ 5.08 2E08 DR BX	G.104
1652050000	BLZ 5.08 2E08 DR BX	G.114
1652050000	BLZ 5.08 2E08 DR BX	L.2
1652060000	BLZ 5.08 2E08 BK BX	G.40
1652060000	BLZ 5.08 2E08 BK BX	L.2
1652070000	BLZ 5.08 2E08 BK BX	G.86
1652070000	BLZ 5.08 2E08 BK BX	G.96
1652070000	BLZ 5.08 2E08 BK BX	G.104
1652070000	BLZ 5.08 2E08 BK BX	G.114
1652070000	BLZ 5.08 2E08 BK BX	L.2
1652100000	BLZ 5.08 2E04 DR BX	G.40
1652100000	BLZ 5.08 2E04 DR BX	L.2
1652110000	BLZ 5.08 2E04 DR BX	G.86
1652110000	BLZ 5.08 2E04 DR BX	G.96
1652110000	BLZ 5.08 2E04 DR BX	G.104
1652110000	BLZ 5.08 2E04 DR BX	G.114
1652110000	BLZ 5.08 2E04 DR BX	L.2
1652130000	BLZ 5.08 2E04 BK BX	G.86
1652130000	BLZ 5.08 2E04 BK BX	G.96
1652130000	BLZ 5.08 2E04 BK BX	G.104
1652130000	BLZ 5.08 2E04 BK BX	G.114
1652250001	KSW 2.5 24/3.5 1-24	L.16
1652260001	KSW 2.5 16/3.5 1-16	L.16
1652270001	KSW 4 12/7.62 1-12	L.16
1652270001	KSW 4 12/7.62 1-12	M.6

## 1660000000

1667750000	LM 3.50/02/90 3.2SN DR BX	C.14
1667770000	LM 3.50/03/90 3.2SN DR BX	C.14
1667810000	TOP4G58/90 6.35 DR	C.40
1669300000	BL/SL 3.50 VR BK BX	E.30
1669300000	BL/SL 3.50 VR BK BX	E.32
1669300000	BL/SL 3.50 VR BK BX	E.34
1669300000	BL/SL 3.50 VR BK BX	E.36
1669300000	BL/SL 3.50 VR BK BX	E.38
1669300000	BL/SL 3.50 VR BK BX	E.40
1669300000	BL/SL 3.50 VR BK BX	E.41
1669300000	BL/SL 3.50 VR BK BX	E.48
1669300000	BL/SL 3.50 VR BK BX	L.5
1669310000	BL/SL 3.50 VR DR BX	E.30
1669310000	BL/SL 3.50 VR DR BX	E.32
1669310000	BL/SL 3.50 VR DR BX	E.34
1669310000	BL/SL 3.50 VR DR BX	E.36
1669310000	BL/SL 3.50 VR DR BX	E.40
1669310000	BL/SL 3.50 VR DR BX	E.41
1669310000	BL/SL 3.50 VR DR BX	E.48
1669310000	BL/SL 3.50 VR DR BX	L.5
1669650000	SLD 3.50V/22/90G 3.2SN DR BX	E.44
1669660000	SLD 3.50V/22/90F 3.2SN DR BX	E.45

## 1680000000

1682730000	BLL 5.08/02/180B 3.2SN DR BX	G.137
1682740000	BLL 5.08/03/180B 3.2SN DR BX	G.137
1682750000	BLL 5.08/04/180B 3.2SN DR BX	G.137
1682760000	BLL 5.08/05/180B 3.2SN DR BX	G.137
1682770000	BLL 5.08/06/180B 3.2SN DR BX	G.137
1682780000	BLL 5.08/07/180B 3.2SN DR BX	G.137
1682790000	BLL 5.08/08/180B 3.2SN DR BX	G.137

Order No.	Type	Page
1682800000	BLL 5.08/09/180B 3.2SN DR BX	G.137
1682810000	BLL 5.08/10/180B 3.2SN DR BX	G.137
1682820000	BLL 5.08/11/180B 3.2SN DR BX	G.137
1682830000	BLL 5.08/12/180B 3.2SN DR BX	G.137
1682840000	BLL 5.08/13/180B 3.2SN DR BX	G.137
1682850000	BLL 5.08/14/180B 3.2SN DR BX	G.137
1682860000	BLL 5.08/15/180B 3.2SN DR BX	G.137
1682870000	BLL 5.08/16/180B 3.2SN DR BX	G.137
1682880000	BLL 5.08/17/180B 3.2SN DR BX	G.137
1682890000	BLL 5.08/18/180B 3.2SN DR BX	G.137
1682900000	BLL 5.08/19/180B 3.2SN DR BX	G.137
1682910000	BLL 5.08/20/180B 3.2SN DR BX	G.137
1682920000	BLL 5.08/21/180B 3.2SN DR BX	G.137
1682930000	BLL 5.08/22/180B 3.2SN DR BX	G.137
1682940000	BLL 5.08/23/180B 3.2SN DR BX	G.137
1682950000	BLL 5.08/24/180B 3.2SN DR BX	G.137
1683990000	TOP1.56S6/90 7.2STI DR	C.38

## 1690000000

1690110000	RSV1.6 RF4/35x15 SW	H.14
1690110000	RSV1.6 RF4/35x15 SW	L.3
1690120000	RSV1.6 RF6/35x15 SW	H.14
1690120000	RSV1.6 RF6/35x15 SW	L.3
1690130000	RSV1.6 RF9/35x15 SW	H.14
1690130000	RSV1.6 RF9/35x15 SW	L.3
1690140000	RSV1.6 RF12/35x15 SW	H.14
1690140000	RSV1.6 RF12/35x15 SW	L.3
1690150000	RSV1.6 RF18/35x15 SW	H.14
1690150000	RSV1.6 RF18/35x15 SW	L.3
1690160000	RSV1.6 RF24/35x15 SW	H.14
1690160000	RSV1.6 RF24/35x15 SW	L.3
1690170000	RSV1.6 RF36/35x15 SW	H.14
1690170000	RSV1.6 RF36/35x15 SW	L.3
1692340000	SLA BB11R SW	G.32
1692340000	SLA BB11R SW	G.34
1692340000	SLA BB11R SW	G.72
1692340000	SLA BB11R SW	G.76
1692340000	SLA BB11R SW	G.96
1692340000	SLA BB11R SW	G.100
1692340000	SLA BB11R SW	G.134
1692340000	SLA BB11R SW	G.136
1692340000	SLA BB11R SW	L.6
1693430000	BL SL 3.5 KO DR	E.30
1693430000	BL SL 3.5 KO DR	E.32
1693430000	BL SL 3.5 KO DR	E.34
1693430000	BL SL 3.5 KO DR	E.36
1693430000	BL SL 3.5 KO DR	E.38
1693430000	BL SL 3.5 KO DR	E.40
1693430000	BL SL 3.5 KO DR	E.41
1693430000	BL SL 3.5 KO DR	E.42
1693430000	BL SL 3.5 KO DR	E.44
1693430000	BL SL 3.5 KO DR	E.46
1693430000	BL SL 3.5 KO DR	E.48
1693430000	BL SL 3.5 KO DR	E.50
1693430000	BL SL 3.5 KO DR	E.54
1693430000	BL SL 3.5 KO DR	E.56
1693430000	BL SL 3.5 KO DR	E.58
1693430000	BL SL 3.5 KO DR	E.60
1693430000	BL SL 3.5 KO DR	E.62
1693430000	BL SL 3.5 KO DR	E.64
1693430000	BL SL 3.5 KO DR	L.10
1695700000	TOP1.56S7/180 5.2STI DR	C.37
1698740000	TOP4G55/90 7.62 DR	C.40
1699580000	S2L/S2C 3.5 FLA 20/10	L.14
1699580000	S2L/S2C 3.5 FLA 20/10	L.18
1699800000	SCT 4.6/127 C	K.40

## 1700000000

1700660001	KSW 2.5 8/5.00 W 1-8	L.16
1700670001	KSW 4 8/5.00 W 1-8	L.16
1700680001	KSW 4 8/7.62 W 1-8	L.16
1700680001	KSW 4 8/7.62 W 1-8	M.6
1700700001	KSW 4 16/5.00 W 1-16	L.16
1700710001	KSW 4 24/5.00 W 1-24	L.16
1703700000	LM2N 3.50/04/90 3.2SN DR BX	C.17
1703710000	LM2N 3.50/06/90 3.2SN DR BX	C.17
1703720000	LM2N 3.50/08/90 3.2SN DR BX	C.17
1703730000	LM2N 3.50/10/90 3.2SN DR BX	C.17
1703740000	LM2N 3.50/12/90 3.2SN DR BX	C.17
1703750000	LM2N 3.50/14/90 3.2SN DR BX	C.17
1703760000	LM2N 3.50/16/90 3.2SN DR BX	C.17
1703770000	LM2N 3.50/18/90 3.2SN DR BX	C.17
1703780000	LM2N 3.50/20/90 3.2SN DR BX	C.17
1703790000	LM2N 3.50/22/90 3.2SN DR BX	C.17
1703800000	LM2N 3.50/24/90 3.2SN DR BX	C.17
1703810000	LM2N 3.50/26/90 3.2SN DR BX	C.17
1703820000	LM2N 3.50/28/90 3.2SN DR BX	C.17
1703830000	LM2N 3.50/30/90 3.2SN DR BX	C.17
1703840000	LM2N 3.50/32/90 3.2SN DR BX	C.17
1703850000	LM2N 3.50/34/90 3.2SN DR BX	C.17
1703860000	LM2N 3.50/36/90 3.2SN DR BX	C.17
1703870000	LM2N 3.50/38/90 3.2SN DR BX	C.17
1703880000	LM2N 3.50/40/90 3.2SN DR BX	C.17
1703890000	LM2N 3.50/42/90 3.2SN DR BX	C.17
1703900000	LM2N 3.50/44/90 3.2SN DR BX	C.17
1703910000	LM2N 3.50/46/90 3.2SN DR BX	C.17
1703920000	LM2N 3.50/48/90 3.2SN DR BX	C.17

Order No.	Type	Page
1707040000	TOP1.56S18/90 5.2STI DR	C.36
1710000000		
1713970001	KSW 2.5 16/5.08 W 1-16	L.16
1713980001	KSW 2.5 24/5.00 W 1-24	L.16
1713990001	KSW 2.5 24/5.08 W 1-24	L.16
1714980000	LM 3.50/02/135 3.2SN DR BX	C.15
1715020000	LM 3.50/03/135 3.2SN DR BX	C.15
1715310000	LM 5.00/02/90 3.5SN DR BX	C.20
1715320000	LM 5.00/03/90 3.5SN DR BX	C.20
1715330000	LM 5.00/02/180 3.5SN DR BX	C.21
1715340000	LM 5.00/03/180 3.5SN DR BX	C.21
1715350000	LM 5.00/02/135 3.5SN DR BX	C.21
1715360000	LM 5.00/03/135 3.5SN DR BX	C.21
1716080000	LM 5.08/02/90 3.5SN DR BX	C.22
1716090000	LM 5.08/03/90 3.5SN DR BX	C.22
1716100000	LM 5.08/02/180 3.5SN DR BX	C.23
1716110000	LM 5.08/03/180 3.5SN DR BX	C.23
1716120000	LM 5.08/02/135 3.5SN DR BX	C.23
1716130000	LM 5.08/03/135 3.5SN DR BX	C.23
1716710000	LM1N 3.50/02/90 3.2SN DR BX	C.16
1716720000	LM1N 3.50/03/90 3.2SN DR BX	C.16

## 1720000000

1720250000	LM 3.50/05/90 3.2SN DR BX	C.14
1723430000	SLA BB1R DR	L.6
1723440000	SLA BB2R DR	L.6
1723480000	SLA BB1R SW	L.6
1723490000	SLA BB2R SW	L.6
1724680000	LL 9.52/02/90 5.0SN DR BX	C.34
1724690000	LL 9.52/03/90 5.0SN DR BX	C.34
1724740000	TOP1.56S13/180 5.2ST DR	C.37
1725170000	SID 5.08V/04/90 3.2 SN DR BX	G.80
1725180000	SID 5.08V/06/90 3.2 SN DR BX	G.80
1725190000	SID 5.08V/08/90 3.2 SN DR BX	G.80
1725200000	SID 5.08V/10/90 3.2 SN DR BX	G.80
1725210000	SID 5.08V/12/90 3.2 SN DR BX	G.80
1725220000	SID 5.08V/14/90 3.2 SN DR BX	G.80
1725230000	SID 5.08V/16/90 3.2 SN DR BX	G.80
1725240000	SID 5.08V/18/90 3.2 SN DR BX	G.80
1725250000	SID 5.08V/20/90 3.2 SN DR BX	G.80
1725260000	SID 5.08V/22/90 3.2 SN DR BX	G.80
1725270000	SID 5.08V/24/90 3.2 SN DR BX	G.80
1725280000	SID 5.08V/26/90 3.2 SN DR BX	G.80
1725290000	SID 5.08V/28/90 3.2 SN DR BX	G.80
1725300000	SID 5.08V/30/90 3.2 SN DR BX	G.80
1725310000	SID 5.08V/32/90 3.2 SN DR BX	G.80
1725320000	SID 5.08V/34/90 3.2 SN DR BX	G.80
1725330000	SID 5.08V/36/90 3.2 SN DR BX	G.80
1725340000	SID 5.08V/38/90 3.2 SN DR BX	G.80
1725350000	SID 5.08V/40/90 3.2 SN DR BX	G.80
1725360000	SID 5.08V/42/90 3.2 SN DR BX	G.80
1725370000	SID 5.08V/44/90 3.2 SN DR BX	G.80
1725380000	SID 5.08V/46/90 3.2 SN DR BX	G.80
1725390000	SID 5.08V/48/90 3.2 SN DR BX	G.80
1725650000	SID 5.08V/04/180 3.2SN DR BX	G.81
1725660000	SID 5.08V/06/180 3.2SN DR BX	G.81
1725670000	SID 5.08V/08/180 3.2SN DR BX	G.81
1725680000		

Table with 4 columns: Order No., Type, Page, and a blank column. Rows include 1752984002, 1752994002, 1753004002, etc.

Table with 4 columns: Order No., Type, Page, and a blank column. Rows include 1769430000, 1769440000, 1769450000, etc.

Table with 4 columns: Order No., Type, Page, and a blank column. Rows include 1775974001, 1776364001, 1776374001, etc.

Table with 4 columns: Order No., Type, Page, and a blank column. Rows include 1781650000, 1781660000, 1781670000, etc.

176000000

Table with 4 columns: Order No., Type, Page, and a blank column. Rows include 1760490000, 1760500000, 1761544002, etc.

177000000

Table with 4 columns: Order No., Type, Page, and a blank column. Rows include 1770240000, 1770240000, 1770240000, etc.

178000000

Table with 4 columns: Order No., Type, Page, and a blank column. Rows include 1780000000, 1780010000, 1780020000, etc.

179000000

Table with 4 columns: Order No., Type, Page, and a blank column. Rows include 1791610000, 1791620000, 1791630000, etc.









Table with 4 columns: Order No., Type, Page, and Order No., Type, Page. Contains 900 rows of part numbers and descriptions.

Table with 4 columns: Order No., Type, Page, and Order No., Type, Page. Contains 900 rows of part numbers and descriptions.

1880000000

Table with 4 columns: Order No., Type, Page, and Order No., Type, Page. Contains 900 rows of part numbers and descriptions.

Table with 4 columns: Order No., Type, Page, and Order No., Type, Page. Contains 900 rows of part numbers and descriptions.



Order No.	Type	Page
1930480000	SV 7.62HP/12/90F 3.5SN BK BX	K.119
1930490000	SV 7.62HP/02/90SF 3.5SN BK BX	K.119
1930500000	SV 7.62HP/03/90SF 3.5SN BK BX	K.119
1930510000	SV 7.62HP/04/90SF 3.5SN BK BX	K.119
1930520000	SV 7.62HP/05/90SF 3.5SN BK BX	K.119
1930530000	SV 7.62HP/06/90SF 3.5SN BK BX	K.119
1930540000	SV 7.62HP/07/90SF 3.5SN BK BX	K.119
1930550000	SV 7.62HP/08/90SF 3.5SN BK BX	K.119
1930560000	SV 7.62HP/09/90SF 3.5SN BK BX	K.119
1930570000	SV 7.62HP/10/90SF 3.5SN BK BX	K.119
1930580000	SV 7.62HP/11/90SF 3.5SN BK BX	K.119
1930590000	SV 7.62HP/12/90SF 3.5SN BK BX	K.119
1930600000	SV 7.62HP/02/180G 3.5SN BK BX	K.122
1930610000	SV 7.62HP/03/180G 3.5SN BK BX	K.122
1930620000	SV 7.62HP/04/180G 3.5SN BK BX	K.122
1930630000	SV 7.62HP/05/180G 3.5SN BK BX	K.122
1930640000	SV 7.62HP/06/180G 3.5SN BK BX	K.122
1930650000	SV 7.62HP/07/180G 3.5SN BK BX	K.122
1930660000	SV 7.62HP/08/180G 3.5SN BK BX	K.122
1930670000	SV 7.62HP/09/180G 3.5SN BK BX	K.122
1930680000	SV 7.62HP/10/180G 3.5SN BK BX	K.122
1930690000	SV 7.62HP/11/180G 3.5SN BK BX	K.122
1930700000	SV 7.62HP/12/180G 3.5SN BK BX	K.122
1930710000	SV 7.62HP/02/180F 3.5SN BK BX	K.123
1930720000	SV 7.62HP/03/180F 3.5SN BK BX	K.123
1930730000	SV 7.62HP/04/180F 3.5SN BK BX	K.123
1930740000	SV 7.62HP/05/180F 3.5SN BK BX	K.123
1930750000	SV 7.62HP/06/180F 3.5SN BK BX	K.123
1930760000	SV 7.62HP/07/180F 3.5SN BK BX	K.123
1930770000	SV 7.62HP/08/180F 3.5SN BK BX	K.123
1930780000	SV 7.62HP/09/180F 3.5SN BK BX	K.123
1930790000	SV 7.62HP/10/180F 3.5SN BK BX	K.123
1930800000	SV 7.62HP/11/180F 3.5SN BK BX	K.123
1930810000	SV 7.62HP/12/180F 3.5SN BK BX	K.123
1930820000	SV 7.62HP/02/180SF 3.5SN BK BX	K.123
1930830000	SV 7.62HP/03/180SF 3.5SN BK BX	K.123
1930840000	SV 7.62HP/04/180SF 3.5SN BK BX	K.123
1930850000	SV 7.62HP/05/180SF 3.5SN BK BX	K.123
1930860000	SV 7.62HP/06/180SF 3.5SN BK BX	K.123
1930870000	SV 7.62HP/07/180SF 3.5SN BK BX	K.123
1930880000	SV 7.62HP/08/180SF 3.5SN BK BX	K.123
1930890000	SV 7.62HP/09/180SF 3.5SN BK BX	K.123
1930900000	SV 7.62HP/10/180SF 3.5SN BK BX	K.123
1930910000	SV 7.62HP/11/180SF 3.5SN BK BX	K.123
1930920000	SV 7.62HP/12/180SF 3.5SN BK BX	K.123
1931260000	SV 7.62HP/02/270G 3.5SN BK BX	K.126
1931270000	SV 7.62HP/03/270G 3.5SN BK BX	K.126
1931280000	SV 7.62HP/04/270G 3.5SN BK BX	K.126
1931290000	SV 7.62HP/05/270G 3.5SN BK BX	K.126
1931300000	SV 7.62HP/06/270G 3.5SN BK BX	K.126
1931310000	SV 7.62HP/07/270G 3.5SN BK BX	K.126
1931320000	SV 7.62HP/08/270G 3.5SN BK BX	K.126
1931330000	SV 7.62HP/09/270G 3.5SN BK BX	K.126
1931340000	SV 7.62HP/10/270G 3.5SN BK BX	K.126
1931350000	SV 7.62HP/11/270G 3.5SN BK BX	K.126
1931360000	SV 7.62HP/12/270G 3.5SN BK BX	K.126
1931370000	SV 7.62HP/02/270F 3.5SN BK BX	K.127
1931380000	SV 7.62HP/03/270F 3.5SN BK BX	K.127
1931390000	SV 7.62HP/04/270F 3.5SN BK BX	K.127
1931400000	SV 7.62HP/05/270F 3.5SN BK BX	K.127
1931410000	SV 7.62HP/06/270F 3.5SN BK BX	K.127
1931420000	SV 7.62HP/07/270F 3.5SN BK BX	K.127
1931430000	SV 7.62HP/08/270F 3.5SN BK BX	K.127
1931440000	SV 7.62HP/09/270F 3.5SN BK BX	K.127
1931450000	SV 7.62HP/10/270F 3.5SN BK BX	K.127
1931460000	SV 7.62HP/11/270F 3.5SN BK BX	K.127
1931470000	SV 7.62HP/12/270F 3.5SN BK BX	K.127
1931480000	SV 7.62HP/02/270SF 3.5SN BK BX	K.127
1931490000	SV 7.62HP/03/270SF 3.5SN BK BX	K.127
1931500000	SV 7.62HP/04/270SF 3.5SN BK BX	K.127
1931510000	SV 7.62HP/05/270SF 3.5SN BK BX	K.127
1931520000	SV 7.62HP/06/270SF 3.5SN BK BX	K.127
1931530000	SV 7.62HP/07/270SF 3.5SN BK BX	K.127
1931540000	SV 7.62HP/08/270SF 3.5SN BK BX	K.127
1931550000	SV 7.62HP/09/270SF 3.5SN BK BX	K.127
1931570000	SV 7.62HP/10/270SF 3.5SN BK BX	K.127
1931580000	SV 7.62HP/11/270SF 3.5SN BK BX	K.127
1931590000	SV 7.62HP/12/270SF 3.5SN BK BX	K.127
1931620000	SVZ 7.62HP/02/180G SN BK BX	K.132
1931630000	SVZ 7.62HP/03/180G SN BK BX	K.132
1931640000	SVZ 7.62HP/04/180G SN BK BX	K.132
1931660000	SVZ 7.62HP/05/180G SN BK BX	K.132
1931670000	SVZ 7.62HP/06/180G SN BK BX	K.132
1931680000	SVZ 7.62HP/07/180G SN BK BX	K.132
1931740000	SVZ 7.62HP/02/180F SN BK BX	K.133
1931760000	SVZ 7.62HP/03/180F SN BK BX	K.133
1931820000	SVZ 7.62HP/04/180F SN BK BX	K.133
1931840000	SVZ 7.62HP/05/180F SN BK BX	K.133
1931850000	SVZ 7.62HP/06/180F SN BK BX	K.133
1931860000	SVZ 7.62HP/07/180F SN BK BX	K.133
1931960000	SVZ 7.62HP/02/180SF SN BK BX	K.133
1931970000	SVZ 7.62HP/03/180SF SN BK BX	K.133
1931980000	SVZ 7.62HP/04/180SF SN BK BX	K.133
1931990000	SVZ 7.62HP/05/180SF SN BK BX	K.133
1932000000	SVZ 7.62HP/06/180SF SN BK BX	K.133
1932010000	SVZ 7.62HP/07/180SF SN BK BX	K.133
1932070000	SVZ 7.62HP/02/180F SN BK BX	K.136
1932080000	SVZ 7.62HP/03/180F SN BK BX	K.136
1932090000	SVZ 7.62HP/04/180F SN BK BX	K.136

Order No.	Type	Page
1932100000	SVZ 7.62HP/05/180F SN BK BX	K.136
1932110000	SVZ 7.62HP/06/180F SN BK BX	K.136
1932120000	SVZ 7.62HP/07/180F SN BK BX	K.136
1932180000	SVZ 7.62HP/02/180SFI SN BK BX	K.137
1932190000	SVZ 7.62HP/03/180SFI SN BK BX	K.137
1932200000	SVZ 7.62HP/04/180SFI SN BK BX	K.137
1932210000	SVZ 7.62HP/05/180SFI SN BK BX	K.137
1932220000	SVZ 7.62HP/06/180SFI SN BK BX	K.137
1932230000	SVZ 7.62HP/07/180SFI SN BK BX	K.137
1932460000	SVZ 7.62HP/03/180SH180 SN BK BX	K.138
1932470000	SVZ 7.62HP/04/180SH180 SN BK BX	K.138
1932480000	SVZ 7.62HP/05/180SH180 SN BK BX	K.138
1932490000	SVZ 7.62HP/06/180SH180 SN BK BX	K.138
1932500000	SVZ 7.62HP/07/180SH180 SN BK BX	K.140
1932510000	SVZ 7.62HP/04/180RSH180 SN BK BX	K.140
1932520000	SVZ 7.62HP/05/180RSH180 SN BK BX	K.140
1932530000	SVZ 7.62HP/06/180RSH180 SN BK BX	K.140
1933160000	SL DN 5.08/5/90F 3.5AU GR	G.116
1933170000	SL DN 5.08/5/90F 3.5AU GR	G.116
1933340000	BVZ 7.62HP/03/180RSH180 SN BK BX	K.161
1933350000	BVZ 7.62HP/04/180RSH180 SN BK BX	K.161
1933360000	BVZ 7.62HP/05/180RSH180 SN BK BX	K.161
1933370000	BVZ 7.62HP/06/180RSH180 SN BK BX	K.161
1933380000	BVZ 7.62HP/03/180SH180 SN BK BX	K.163
1933390000	BVZ 7.62HP/04/180SH180 SN BK BX	K.163
1933400000	BVZ 7.62HP/05/180SH180 SN BK BX	K.163
1933410000	BVZ 7.62HP/06/180SH180 SN BK BX	K.163
1933430000	BVZ 7.62HP/04/180RSH200 SN BK BX	K.161
1933440000	BVZ 7.62HP/05/180RSH200 SN BK BX	K.161
1933460000	BVZ 7.62HP/06/180RSH200 SN BK BX	K.161
1933470000	BVZ 7.62HP/03/180SH210 SN BK BX	K.163
1933480000	BVZ 7.62HP/04/180SH210 SN BK BX	K.163
1933490000	BVZ 7.62HP/05/180SH210 SN BK BX	K.163
1933500000	BVZ 7.62HP/06/180SH210 SN BK BX	K.163
1933550000	BLZ DN 5.08/05/180F AU GY BX PRT	G.119
1933560000	BLZ DN 5.08/05/180F AU GY BX SO	G.119
1933570000	BLZ DN 5.08/05/180F AU GY BX SO	G.119
1934050000	WGK V 4 GY BX	L.13
1934140000	LU 10.16/02/90 4.5SN BK BX	J.18
1934250000	LL 5.08/02/90 3.2SN OR BX	C.29
1934260000	LL 5.08/03/90 3.2SN OR BX	C.29
1934270000	LL 5.00/02/90 3.2SN OR BX	C.28
1934280000	LL 5.00/03/90 3.2SN OR BX	C.28
1934310000	LL2N 5.00/04/90 3.2SN OR BX	C.31
1934340000	LL3R 5.08/06/90 3.2SN OR BX	C.33
1934360000	LL3R 5.00/06/90 3.2SN OR BX	C.31
1936340000	SL-SMT 3.50/10/180FL 1.5SN BK RL	E.35
1936430000	DP VWG 4 GY BX	L.12
1936450000	DP VWG 4 GY BX	L.12
1936470000	DP VWG 4 GY BX	L.12
1936480000	VWGK 4 GN/YE BX	L.13
1936490000	VWGK 4 GY BX	L.13
1936540000	WGK 4 GN/YE BX	L.12
1936550000	WGK 4 GY BX	L.12
1936560000	WGK 4/Z GN/YE BX	L.12
1936570000	WGK 4/Z GY BX	L.12
1936610000	WGK 4 GN/YE BX	L.13
1936620000	WGK 4/Z GN/YE BX	L.13
1936630000	WGK 4/Z GY BX	L.13
1936690000	DP VWG V 25	L.20
1936700000	DP VWG 16 GY BX	L.18
1936710000	DP VWG 25 GY BX	L.20
1937020000	DP VWG 95 GY BX	L.24
1937030000	DP VWG 50	L.22
1937120000	WGK 95F VP GN/YE BX	L.25
1937130000	WGK 95F VP GY BX	L.25
1937140000	WGK 95F VP/Z GY BX	L.25
1937360000	WGK 95F VP/Z GN/YE BX	L.25
1937370000	WGK 95 GN/YE BX	L.24
1937380000	WGK 95 GY BX	L.24
1937390000	WGK 95/Z GN/YE BX	L.24
1937400000	WGK 95/Z GY BX	L.24
1937550000	BV/SV 7.62HP/02 ZE GR	K.64
1937560000	BV/SV 7.62HP/02 ZE GR	K.132
1937570000	BV/SV 7.62HP/02 ZE GR	K.134
1937580000	BV/SV 7.62HP/02 ZE GR	K.136
1937590000	BV/SV 7.62HP/02 ZE GR	K.160
1937550000	BV/SV 7.62HP/02 ZE GR	K.162
1937560000	BV/SV 7.62HP/02 ZE GR	K.166
1937570000	BV/SV 7.62HP/02 ZE GR	M.2
1937580000	BV/SV 7.62HP/04 ZE GR	K.64
1937590000	BV/SV 7.62HP/04 ZE GR	K.132
1937600000	BV/SV 7.62HP/04 ZE GR	K.134
1937610000	BV/SV 7.62HP/04 ZE GR	K.136
1937620000	BV/SV 7.62HP/04 ZE GR	K.158
1937630000	BV/SV 7.62HP/04 ZE GR	K.162
1937640000	BV/SV 7.62HP/04 ZE GR	K.166
1937650000	BV/SV 7.62HP/04 ZE GR	M.2
1937950000	BV/SV 7.62HP KO	K.8
1937960000	BV/SV 7.62HP KO	K.10
1937970000	BV/SV 7.62HP KO	K.12
1937980000	BV/SV 7.62HP KO	K.14
1937990000	BV/SV 7.62HP KO	K.16
1938000000	BV/SV 7.62HP KO	K.18
1938010000	BV/SV 7.62HP KO	K.20
1938020000	BV/SV 7.62HP KO	K.22

Order No.	Type	Page
1937590000	BV/SV 7.62HP KO	K.24
1937590000	BV/SV 7.62HP KO	K.26
1937590000	BV/SV 7.62HP KO	K.28
1937590000	BV/SV 7.62HP KO	K.30
1937590000	BV/SV 7.62HP KO	K.32
1937590000	BV/SV 7.62HP KO	K.34
1937590000	BV/SV 7.62HP KO	K.36
1937590000	BV/SV 7.62HP KO	K.38
1937590000	BV/SV 7.62HP KO	K.40
1937590000	BV/SV 7.62HP KO	K.42
1937590000	BV/SV 7.62HP KO	K.44
1937590000	BV/SV 7.62HP KO	K.56
1937590000	BV/SV 7.62HP KO	K.58
1937590000	BV/SV 7.62HP KO	K.60
1937590000	BV/SV 7.62HP KO	K.62
1937590000	BV/SV 7.62HP KO	K.64
1937590000	BV/SV 7.62HP KO	K.110
1937590000	BV/SV 7.62HP KO	K.112
1937590000	BV/SV 7.62HP KO	K.114
1937590000	BV/SV 7.62HP KO	K.116
1937590000	BV/SV 7.62HP KO	K.118
1937590000	BV/SV 7.62HP KO	K.120
1937590000	BV/SV 7.62HP KO	K.122
1937590000	BV/SV 7.62HP KO	K.124
1937590000	BV/SV 7.62HP KO	K.126
1937590000	BV/SV 7.62HP KO	K.128
1937590000	BV/SV 7.62HP KO	K.130
1937590000	BV/SV 7.62HP KO	K.132
1937590000	BV/SV 7.62HP KO	K.134
1937590000	BV/SV 7.62HP KO	K.136
1937590000	BV/SV 7.62HP KO	K.138
1937590000	BV/SV 7.62HP KO	K.139
1937590000	BV/SV 7.62HP KO	K.140
1937590000	BV/SV 7.62HP KO	K.142
1937590000	BV/SV 7.62HP KO	K.144
1937590000	BV/SV 7.62HP KO	K.146
1937590000	BV/SV 7.62HP KO	K.148
1937590000	BV/SV 7.62HP KO	K.150
1937590000	BV/SV 7.62HP KO	K.152
1937590000	BV/SV 7.62HP KO	K.154
1937590000	BV/SV 7.62HP KO	K.158
1937590000	BV/SV 7.62HP KO	K.160
1937590000	BV/SV 7.62HP KO	K.162
1937590000	BV/SV 7.62HP KO	K.164
1937590000	BV/SV 7.62HP KO	K.166
1937590000	BV/SV 7.62HP KO	M.4
1937590000	BV/SV 7.62HP KO	K.170
1937590000	BV/SV 7.62HP KO	K.172
1937590000	BV/SV 7.62HP KO	K.174
1937590000	BV/SV 7.62HP KO	K.176
1937590000	BV/SV 7.62HP KO	



Order No.	Type	Page
1955780000	BLZP 5.00HC/04/180F SN OR BX	G.41
1955790000	BLZP 5.00HC/03/180F SN OR BX	G.41
1955800000	BLZP 5.00HC/02/180F SN OR BX	G.41
1956150000	BLZP 5.00HC/24/180L SN OR BX	G.41
1956160000	BLZP 5.00HC/23/180L SN OR BX	G.41
1956170000	BLZP 5.00HC/22/180L SN OR BX	G.41
1956180000	BLZP 5.00HC/21/180L SN OR BX	G.41
1956190000	BLZP 5.00HC/20/180L SN OR BX	G.41
1956200000	BLZP 5.00HC/19/180L SN OR BX	G.41
1956210000	BLZP 5.00HC/18/180L SN OR BX	G.41
1956220000	BLZP 5.00HC/17/180L SN OR BX	G.41
1956230000	BLZP 5.00HC/16/180L SN OR BX	G.41
1956240000	BLZP 5.00HC/15/180L SN OR BX	G.41
1956250000	BLZP 5.00HC/14/180L SN OR BX	G.41
1956260000	BLZP 5.00HC/13/180L SN OR BX	G.41
1956270000	BLZP 5.00HC/12/180L SN OR BX	G.41
1956280000	BLZP 5.00HC/11/180L SN OR BX	G.41
1956290000	BLZP 5.00HC/10/180L SN OR BX	G.41
1956300000	BLZP 5.00HC/09/180L SN OR BX	G.41
1956310000	BLZP 5.00HC/08/180L SN OR BX	G.41
1956320000	BLZP 5.00HC/07/180L SN OR BX	G.41
1956330000	BLZP 5.00HC/06/180L SN OR BX	G.41
1956340000	BLZP 5.00HC/05/180L SN OR BX	G.41
1956350000	BLZP 5.00HC/04/180L SN OR BX	G.41
1956360000	BLZP 5.00HC/03/180L SN OR BX	G.41
1956370000	BLZP 5.00HC/02/180L SN OR BX	G.41
1957780000	BLZP 5.00HC/24/90 SN OR BX	G.42
1957800000	BLZP 5.00HC/23/90 SN OR BX	G.42
1957820000	BLZP 5.00HC/22/90 SN OR BX	G.42
1957830000	BLZP 5.00HC/21/90 SN OR BX	G.42
1957850000	BLZP 5.00HC/20/90 SN OR BX	G.42
1957880000	BLZP 5.00HC/19/90 SN OR BX	G.42
1957900000	BLZP 5.00HC/18/90 SN OR BX	G.42
1957910000	BLZP 5.00HC/17/90 SN OR BX	G.42
1957960000	BLZP 5.00HC/16/90 SN OR BX	G.42
1958040000	BLZP 5.00HC/15/90 SN OR BX	G.42
1958060000	BLZP 5.00HC/14/90 SN OR BX	G.42
1958090000	BLZP 5.00HC/13/90 SN OR BX	G.42
1958120000	BLZP 5.00HC/12/90 SN OR BX	G.42
1958130000	BLZP 5.00HC/11/90 SN OR BX	G.42
1958160000	BLZP 5.00HC/10/90 SN OR BX	G.42
1958190000	BLZP 5.00HC/09/90 SN OR BX	G.42
1958230000	BLZP 5.00HC/08/90 SN OR BX	G.42
1958250000	BLZP 5.00HC/07/90 SN OR BX	G.42
1958260000	BLZP 5.00HC/06/90 SN OR BX	G.42
1958270000	BLZP 5.00HC/05/90 SN OR BX	G.42
1958280000	BLZP 5.00HC/04/90 SN OR BX	G.42
1958290000	BLZP 5.00HC/03/90 SN OR BX	G.42
1958300000	BLZP 5.00HC/02/90 SN OR BX	G.42
1958320000	LMZF 5/13/135 3.50R	C.97
1958330000	LMZF 5/14/135 3.50R	C.97
1958350000	LMZF 5/15/135 3.50R	C.97
1958370000	LMZF 5/16/135 3.50R	C.97
1958390000	LMZF 5/17/135 3.50R	C.97
1958410000	LMZF 5/18/135 3.50R	C.97
1958440000	LMZF 5/19/135 3.50R	C.97
1958450000	LMZF 5/20/135 3.50R	C.97
1958470000	LMZF 5/21/135 3.50R	C.97
1958490000	LMZF 5/22/135 3.50R	C.97
1958500000	LMZF 5/23/135 3.50R	C.97
1958510000	LMZF 5/24/135 3.50R	C.97
1958660000	BLZP 5.00HC/24/270 SN OR BX	G.44
1958670000	BLZP 5.00HC/23/270 SN OR BX	G.44
1958680000	BLZP 5.00HC/22/270 SN OR BX	G.44
1958690000	BLZP 5.00HC/21/270 SN OR BX	G.44
1958700000	BLZP 5.00HC/20/270 SN OR BX	G.44
1958710000	BLZP 5.00HC/19/270 SN OR BX	G.44
1958720000	BLZP 5.00HC/18/270 SN OR BX	G.44
1958730000	BLZP 5.00HC/17/270 SN OR BX	G.44
1958740000	BLZP 5.00HC/16/270 SN OR BX	G.44
1958750000	BLZP 5.00HC/15/270 SN OR BX	G.44
1958760000	BLZP 5.00HC/14/270 SN OR BX	G.44
1958770000	BLZP 5.00HC/13/270 SN OR BX	G.44
1958780000	BLZP 5.00HC/12/270 SN OR BX	G.44
1958790000	BLZP 5.00HC/11/270 SN OR BX	G.44
1958800000	BLZP 5.00HC/10/270 SN OR BX	G.44
1958810000	BLZP 5.00HC/09/270 SN OR BX	G.44
1958820000	BLZP 5.00HC/08/270 SN OR BX	G.44
1958830000	BLZP 5.00HC/07/270 SN OR BX	G.44
1958830000	BLZP 5.00HC/06/270 SN OR BX	G.44
1958840000	BLZP 5.00HC/05/270 SN OR BX	G.44
1958850000	BLZP 5.00HC/04/270 SN OR BX	G.44
1958860000	BLZP 5.00HC/03/270 SN OR BX	G.44
1958870000	BLZP 5.00HC/02/270 SN OR BX	G.44
1959150000	BLZP 5.00HC/12/270F SN OR BX	G.45
1959170000	BLZP 5.00HC/24/270F SN OR BX	G.45
1959180000	BLZP 5.00HC/23/270F SN OR BX	G.45
1959190000	BLZP 5.00HC/22/270F SN OR BX	G.45
1959200000	BLZP 5.00HC/21/270F SN OR BX	G.45
1959210000	BLZP 5.00HC/20/270F SN OR BX	G.45
1959220000	BLZP 5.00HC/19/270F SN OR BX	G.45
1959230000	BLZP 5.00HC/18/270F SN OR BX	G.45
1959240000	BLZP 5.00HC/17/270F SN OR BX	G.45
1959250000	BLZP 5.00HC/16/270F SN OR BX	G.45
1959260000	BLZP 5.00HC/15/270F SN OR BX	G.45
1959270000	BLZP 5.00HC/14/270F SN OR BX	G.45
1959280000	BLZP 5.00HC/13/270F SN OR BX	G.45
1959290000	BLZP 5.00HC/12/270F SN OR BX	G.45
1959300000	BLZP 5.00HC/11/270F SN OR BX	G.45
1959310000	BLZP 5.00HC/10/270F SN OR BX	G.45

Order No.	Type	Page
1959320000	BLZP 5.00HC/09/90F SN OR BX	G.43
1959330000	BLZP 5.00HC/08/90F SN OR BX	G.43
1959340000	BLZP 5.00HC/07/90F SN OR BX	G.43
1959350000	BLZP 5.00HC/06/90F SN OR BX	G.43
1959360000	BLZP 5.00HC/05/90F SN OR BX	G.43
1959370000	BLZP 5.00HC/04/90F SN OR BX	G.43
1959380000	BLZP 5.00HC/03/90F SN OR BX	G.43
1959390000	BLZP 5.00HC/02/90F SN OR BX	G.43
1959400000	BLZP 5.00HC/15/270F SN OR BX	G.45
1959410000	BLZP 5.00HC/14/270F SN OR BX	G.45
1959420000	BLZP 5.00HC/13/270F SN OR BX	G.45
1959430000	BLZP 5.00HC/12/270F SN OR BX	G.45
1959440000	BLZP 5.00HC/11/270F SN OR BX	G.45
1959450000	BLZP 5.00HC/10/270F SN OR BX	G.45
1959460000	BLZP 5.00HC/09/270F SN OR BX	G.45
1959470000	BLZP 5.00HC/08/270F SN OR BX	G.45
1959480000	BLZP 5.00HC/07/270F SN OR BX	G.45
1959490000	BLZP 5.00HC/06/270F SN OR BX	G.45
1959500000	BLZP 5.00HC/05/270F SN OR BX	G.45
1959510000	BLZP 5.00HC/04/270F SN OR BX	G.45
1959520000	BLZP 5.00HC/03/270F SN OR BX	G.45

## 1960000000

1960140000	LMZF 5/13/135 3.50R	C.96
1960150000	LMZF 5/14/135 3.50R	C.96
1960160000	LMZF 5/15/135 3.50R	C.96
1960170000	LMZF 5/16/135 3.50R	C.96
1960180000	LMZF 5/17/135 3.50R	C.96
1960190000	LMZF 5/18/135 3.50R	C.96
1960200000	LMZF 5/19/135 3.50R	C.96
1960210000	LMZF 5/20/135 3.50R	C.96
1960220000	LMZF 5/21/135 3.50R	C.96
1960230000	LMZF 5/22/135 3.50R	C.96
1960240000	LMZF 5/23/135 3.50R	C.96
1960250000	LMZF 5/24/135 3.50R	C.96
1960370000	BLZP 5.00HC/11/270F SN OR BX	G.45
1960380000	BLZP 5.00HC/10/270F SN OR BX	G.45
1960390000	BLZP 5.00HC/09/270F SN OR BX	G.45
1960400000	BLZP 5.00HC/08/270F SN OR BX	G.45
1960410000	BLZP 5.00HC/07/270F SN OR BX	G.45
1960420000	BLZP 5.00HC/06/270F SN OR BX	G.45
1960430000	BLZP 5.00HC/05/270F SN OR BX	G.45
1960440000	BLZP 5.00HC/04/270F SN OR BX	G.45
1960450000	BLZP 5.00HC/03/270F SN OR BX	G.45
1960460000	BLZP 5.00HC/02/270F SN OR BX	G.45
1960740000	BLZP 5.00HC/24/270L SN OR BX	G.45
1960750000	BLZP 5.00HC/23/270L SN OR BX	G.45
1960760000	BLZP 5.00HC/22/270L SN OR BX	G.45
1960770000	BLZP 5.00HC/21/270L SN OR BX	G.45
1960780000	BLZP 5.00HC/20/270L SN OR BX	G.45
1960790000	BLZP 5.00HC/19/270L SN OR BX	G.45
1960800000	BLZP 5.00HC/18/270L SN OR BX	G.45
1960810000	BLZP 5.00HC/17/270L SN OR BX	G.45
1960820000	BLZP 5.00HC/16/270L SN OR BX	G.45
1960830000	BLZP 5.00HC/15/270L SN OR BX	G.45
1960840000	BLZP 5.00HC/14/270L SN OR BX	G.45
1960850000	BLZP 5.00HC/13/270L SN OR BX	G.45
1960860000	BLZP 5.00HC/12/270L SN OR BX	G.45
1960870000	BLZP 5.00HC/11/270L SN OR BX	G.45
1960880000	BLZP 5.00HC/10/270L SN OR BX	G.45
1960890000	BLZP 5.00HC/09/270L SN OR BX	G.45
1960900000	BLZP 5.00HC/08/270L SN OR BX	G.45
1960910000	BLZP 5.00HC/07/270L SN OR BX	G.45
1960920000	BLZP 5.00HC/06/270L SN OR BX	G.45
1960930000	BLZP 5.00HC/05/270L SN OR BX	G.45
1960940000	BLZP 5.00HC/04/270L SN OR BX	G.45
1960950000	BLZP 5.00HC/03/270L SN OR BX	G.45
1960960000	BLZP 5.00HC/02/270L SN OR BX	G.45
1961880000	AP 90 OR	N.49
1961890000	AP 90 GR	N.49
1962250000	MTA 45 BK	N.52
1962400000	SUZ 10.16HP/08/180G AG BK BX	K.196
1965750000	DP VWG 6 GY BX	L.14
1965750000	DP VWG 6 GY BX	L.16
1965940000	Bl-I/D 3.50/10F PNP LED SN LTGY BX	E.58
1965970000	Bl-I/D 3.00/30F PNP LED SN LTGY BX	E.59
1966910000	SUZ 10.16HP/09/180G AG BK BX	K.196
1966920000	SUZ 10.16HP/06/180G AG BK BX	K.196
1966930000	SUZ 10.16HP/07/180G AG BK BX	K.196
1968900000	SC-SMT 3.81 KO GY BX	F.8
1968900000	SC-SMT 3.81 KO GY BX	F.10
1968900000	SC-SMT 3.81 KO GY BX	F.12
1968900000	SC-SMT 3.81 KO GY BX	F.14
1968900000	SC-SMT 3.81 KO GY BX	F.16
1968900000	SC-SMT 3.81 KO GY BX	F.18
1968900000	SC-SMT 3.81 KO GY BX	F.20
1968900000	SC-SMT 3.81 KO GY BX	F.22
1968900000	SC-SMT 3.81 KO GY BX	F.24
1968900000	SC-SMT 3.81 KO GY BX	F.26
1968900000	SC-SMT 3.81 KO GY BX	F.28
1968900000	SC-SMT 3.81 KO GY BX	F.30
1968900000	SC-SMT 3.81 KO GY BX	F.32
1968900000	SC-SMT 3.81 KO GY BX	F.34
1968900000	SC-SMT 3.81 KO GY BX	F.36
1968900000	SC-SMT 3.81 KO GY BX	F.38
1968900000	SC-SMT 3.81 KO GY BX	F.40
1968900000	SC-SMT 3.81 KO GY BX	F.42
1968900000	SC-SMT 3.81 KO GY BX	F.44

Order No.	Type	Page
1968900000	SC-SMT 3.81 KO GY BX	F.46
1969090000	BCF 3.81/02/180 SN OR BX	F.54
1969100000	BCF 3.81/03/180 SN OR BX	F.54
1969110000	BCF 3.81/04/180 SN OR BX	F.54
1969120000	BCF 3.81/05/180 SN OR BX	F.54
1969130000	BCF 3.81/06/180 SN OR BX	F.54
1969140000	BCF 3.81/07/180 SN OR BX	F.54
1969150000	BCF 3.81/08/180 SN OR BX	F.54
1969160000	BCF 3.81/09/180 SN OR BX	F.54
1969170000	BCF 3.81/10/180 SN OR BX	F.54
1969180000	BCF 3.81/11/180 SN OR BX	F.54
1969190000	BCF 3.81/12/180 SN OR BX	F.54
1969200000	BCF 3.81/13/180 SN OR BX	F.54
1969210000	BCF 3.81/14/180 SN OR BX	F.54
1969220000	BCF 3.81/15/180 SN OR BX	F.54
1969230000	BCF 3.81/16/180 SN OR BX	F.54
1969240000	BCF 3.81/17/180 SN OR BX	F.54
1969250000	BCF 3.81/18/180 SN OR BX	F.54
1969520000	SC2 3.81/02/180G SN OR BX	F.44
1969540000	SC2 3.81/03/180G SN OR BX	F.44
1969560000	SC2 3.81/04/180G SN OR BX	F.44
1969570000	SC2 3.81/05/180G SN OR BX	F.44
1969580000	SC2 3.81/06/180G SN OR BX	F.44
1969590000	SC2 3.81/07/180G SN OR BX	F.44
1969610000	SC2 3.81/08/180G SN OR BX	F.44
1969630000	SC2 3.81/09/180G SN OR BX	F.44
1969640000	SC2 3.81/10/180G SN OR BX	F.44
1969660000	SC2 3.81/11/180G SN OR BX	F.44
1969670000	SC2 3.81/12/180G SN OR BX	F.44

## 1970000000

1970260000	SCZ 3.81/02/180F SN OR BX	F.45
1970270000	SCZ 3.81/03/180F SN OR BX	F.45
1970300000	BCF 3.81/02/180F SN OR BX	F.55
1970310000	BCF 3.81/03/180F SN OR BX	F.55
1970320000	BCF 3.81/04/180F SN OR BX	F.55
1970330000	BCF 3.81/05/180F SN OR BX	F.55
1970340000	BCF 3.81/06/180F SN OR BX	F.55
1970350000	BCF 3.81/07/180F SN OR BX	F.55
1970360000	BCF 3.81/0	



Order No.	Type	Page
2439520000	WGKV 10 GY BX	L17
2439530000	WGKV 10 GN/YE BX	L17
2439540000	WGKV 10 Z GN/YE BX	L17
2439550000	WGKV 10 Z GY BX	L17
2439570000	WGKV 10 BK BX	L17
2439580000	WGKV 10 Z BK BX	L17
2439600000	WGK 16 GN/YE BX	L18
2439650000	BLF 2.50/03/180 SN BK BX	D.8
2439660000	SL 2.50/02/90G 3.2SN BK BX	D.6
2439670000	BLF 2.50/04/180 SN BK BX	D.8
2439680000	BLF 2.50/05/180 SN BK BX	D.8
2439690000	BLF 2.50/06/180 SN BK BX	D.8
2439700000	BLF 2.50/07/180 SN BK BX	D.8
2439710000	BLF 2.50/08/180 SN BK BX	D.8
2439720000	BLF 2.50/09/180 SN BK BX	D.8
2439730000	BLF 2.50/10/180 SN BK BX	D.8
2439740000	BLF 2.50/11/180 SN BK BX	D.8
2439750000	BLF 2.50/12/180 SN BK BX	D.8
2439760000	SL 2.50/03/90G 3.2SN BK BX	D.6
2439770000	SL 2.50/04/90G 3.2SN BK BX	D.6
2439780000	SL 2.50/05/90G 3.2SN BK BX	D.6
2439790000	SL 2.50/06/90G 3.2SN BK BX	D.6
2439800000	SL 2.50/07/90G 3.2SN BK BX	D.6
2439810000	SL 2.50/08/90G 3.2SN BK BX	D.6
2439820000	SL 2.50/09/90G 3.2SN BK BX	D.6
2439830000	SL 2.50/10/90G 3.2SN BK BX	D.6
2439840000	SL 2.50/11/90G 3.2SN BK BX	D.6
2439850000	SL 2.50/12/90G 3.2SN BK BX	D.6
2439890000	SL 2.50/02/180G 3.2SN BK BX	D.7
2439900000	SL 2.50/03/180G 3.2SN BK BX	D.7
2439910000	SL 2.50/04/180G 3.2SN BK BX	D.7
2439920000	SL 2.50/05/180G 3.2SN BK BX	D.7
2439930000	SL 2.50/06/180G 3.2SN BK BX	D.7
2439940000	SL 2.50/07/180G 3.2SN BK BX	D.7
2439950000	SL 2.50/08/180G 3.2SN BK BX	D.7
2439960000	SL 2.50/09/180G 3.2SN BK BX	D.7
2439970000	SL 2.50/10/180G 3.2SN BK BX	D.7

## 2440000000

2440000000	SL 2.50/11/180G 3.2SN BK BX	D.7
2440010000	SL 2.50/12/180G 3.2SN BK BX	D.7
2440560000	WGK 16 GY BX	L18
2440570000	WGK 16 Z GN/YE BX	L18
2440580000	WGK 16 Z GY BX	L18
2440590000	WGK 16 BK BX	L18
2440600000	WGK 16 Z BK BX	L18
2440610000	WGK 16 VP GN/YE BX	L19
2440620000	WGK 16 VP GY BX	L19
2440630000	WGK 16 VP Z GN/YE BX	L19
2440640000	WGK 16 VP Z GY BX	L19
2440650000	WGK 16 VP BK BX	L19
2440660000	WGK 16 VP Z BK BX	L19
2440710000	WGK 16 VP Z BK BX	L19
2440720000	WGKV 16 Z GN/YE BX	L19
2440730000	WGKV 16 Z GY BX	L19
2440740000	WGKV 16 GN/YE BX	L19
2440750000	WGKV 16 GY BX	L19
2440790000	WGKV 16 BK BX	L19
2440800000	WGKV 16 Z BK BX	L19
2442030000	BCF 3.81/05/180LZR SN OR BX	F.51
2442040000	BCF 3.81/02/180LZR SN OR BX	F.55
2442050000	SCZ 3.81/02/180LZR SN OR BX	F.45
2442160000	BCZ 3.81/16/180LZR SN OR BX	F.51
2442170000	BCZ 3.81/18/180LZR SN OR BX	F.51
2442180000	BCZ 3.81/20/180LZR SN OR BX	F.51
2442190000	BCZ 3.81/13/180LZR SN OR BX	F.51
2442200000	BCZ 3.81/15/180LZR SN OR BX	F.51
2442210000	BCZ 3.81/07/180LZR SN OR BX	F.51
2442220000	BCZ 3.81/11/180LZR SN OR BX	F.51
2442230000	BCZ 3.81/19/180LZR SN OR BX	F.51
2442240000	BCZ 3.81/10/180LZR SN OR BX	F.51
2442250000	BCZ 3.81/17/180LZR SN OR BX	F.51
2442260000	BCZ 3.81/06/180LZR SN OR BX	F.51
2442270000	BCZ 3.81/12/180LZR SN OR BX	F.51
2442280000	BCZ 3.81/14/180LZR SN OR BX	F.51
2442290000	BCZ 3.81/08/180LZR SN OR BX	F.51
2442300000	BCZ 3.81/09/180LZR SN OR BX	F.51
2442310000	BCZ 3.81/04/180LZR SN OR BX	F.49
2442320000	BCZ 3.81/05/180LZR SN OR BX	F.49
2442330000	BCZ 3.81/06/180LZR SN OR BX	F.49
2442340000	BCZ 3.81/07/180LZR SN OR BX	F.49
2442350000	BCZ 3.81/11/180LZR SN OR BX	F.49
2442360000	BCZ 3.81/02/180LZR SN OR BX	F.49
2442370000	BCZ 3.81/03/180LZR SN OR BX	F.49
2442380000	BCZ 3.81/08/180LZR SN OR BX	F.49
2442390000	BCZ 3.81/09/180LZR SN OR BX	F.49
2442400000	BCZ 3.81/10/180LZR SN OR BX	F.49
2442410000	BCZ 3.81/12/180LZR SN OR BX	F.49
2442420000	BCZ 3.81/14/180LZR SN OR BX	F.49
2442430000	BCZ 3.81/15/180LZR SN OR BX	F.49
2442440000	BCZ 3.81/17/180LZR SN OR BX	F.49
2442450000	BCZ 3.81/18/180LZR SN OR BX	F.49
2442460000	BCZ 3.81/13/180LZR SN OR BX	F.49
2442470000	BCZ 3.81/19/180LZR SN OR BX	F.49
2442500000	BCZ 3.81/16/180LZR SN OR BX	F.49
2442510000	BCZ 3.81/20/180LZR SN OR BX	F.49
2442610000	BCF 3.81/03/180LZR SN OR BX	F.55
2442620000	BCF 3.81/04/180LZR SN OR BX	F.55
2442630000	BCF 3.81/05/180LZR SN OR BX	F.55

Order No.	Type	Page
2442640000	BCF 3.81/06/180LZR SN OR BX	F.55
2442650000	BCF 3.81/07/180LZR SN OR BX	F.55
2442660000	BCF 3.81/08/180LZR SN OR BX	F.55
2442670000	BCF 3.81/09/180LZR SN OR BX	F.55
2442680000	BCF 3.81/10/180LZR SN OR BX	F.55
2442690000	BCF 3.81/11/180LZR SN OR BX	F.55
2442700000	BCF 3.81/12/180LZR SN OR BX	F.55
2442710000	BCF 3.81/13/180LZR SN OR BX	F.55
2442720000	BCF 3.81/14/180LZR SN OR BX	F.55
2442730000	BCF 3.81/15/180LZR SN OR BX	F.55
2442740000	BCF 3.81/16/180LZR SN OR BX	F.55
2442750000	BCF 3.81/17/180LZR SN OR BX	F.55
2442760000	BCF 3.81/18/180LZR SN OR BX	F.55
2442910000	BCF 3.81/10/180LZR SN OR BX	F.57
2442920000	BCF 3.81/11/180LZR SN OR BX	F.57
2442930000	BCF 3.81/13/180LZR SN OR BX	F.57
2442940000	BCF 3.81/16/180LZR SN OR BX	F.57
2442950000	BCF 3.81/18/180LZR SN OR BX	F.57
2442960000	BCF 3.81/05/180LZR SN OR BX	F.57
2442970000	BCF 3.81/17/180LZR SN OR BX	F.57
2442980000	BCF 3.81/15/180LZR SN OR BX	F.57
2442990000	BCF 3.81/14/180LZR SN OR BX	F.57
2443010000	BCF 3.81/06/180LZR SN OR BX	F.57
2443020000	BCF 3.81/08/180LZR SN OR BX	F.57
2443030000	BCF 3.81/09/180LZR SN OR BX	F.57
2443050000	BCF 3.81/12/180LZR SN OR BX	F.57
2443060000	SCZ 3.81/07/180LZR SN OR BX	F.45
2444060000	SCZ 3.81/03/180LZR SN OR BX	F.45
2444090000	SCZ 3.81/04/180LZR SN OR BX	F.45
2444100000	SCZ 3.81/05/180LZR SN OR BX	F.45
2444110000	SCZ 3.81/06/180LZR SN OR BX	F.45
2444120000	SCZ 3.81/07/180LZR SN OR BX	F.45
2444130000	SCZ 3.81/08/180LZR SN OR BX	F.45
2444140000	SCZ 3.81/09/180LZR SN OR BX	F.45
2444150000	SCZ 3.81/10/180LZR SN OR BX	F.45
2444160000	SCZ 3.81/11/180LZR SN OR BX	F.45
2444170000	SCZ 3.81/12/180LZR SN OR BX	F.45
2442000000	SCZ 3.81/07/180LZR SN OR BX	F.47
2442200000	SCZ 3.81/05/180LZR SN OR BX	F.47
2442300000	SCZ 3.81/09/180LZR SN OR BX	F.47
2442400000	SCZ 3.81/04/180LZR SN OR BX	F.47
2442500000	SCZ 3.81/11/180LZR SN OR BX	F.47
2442600000	SCZ 3.81/08/180LZR SN OR BX	F.47
2442700000	SCZ 3.81/06/180LZR SN OR BX	F.47
2442800000	SCZ 3.81/12/180LZR SN OR BX	F.47
2442900000	WGK 25/2 GY BX	L.20
2444640000	WGK 25/2 GN/YE BX	L.20
2444650000	WGK 25 GN/YE BX	L.20
2444660000	WGK 25 GY BX	L.20
2444670000	WGK 25 BK BX	L.20
2444680000	WGK 25 Z BK BX	L.20
2444700000	WGK 25 VP GN/YE BX	L.21
2444710000	WGK 25 VP GY BX	L.21
2444720000	WGK 25 VP Z GN/YE BX	L.21
2444730000	WGK 25 VP Z GY BX	L.21
2444790000	WGK 25 VP Z BK BX	L.21
2444810000	WGK 25 Z GN/YE BX	L.21
2444820000	WGK 25 GY BX	L.21
2444830000	WGK 25 GN/YE BX	L.21
2444840000	WGK 25 BK BX	L.21
2444860000	WGK 25 Z GY BX	L.21
2444870000	WGK 25 Z BK BX	L.21

## 2450000000

2453690000	LUF 10.00/02/90V 5.0SN BK BX	J.33
2453700000	LUF 10.00/03/90V 5.0SN BK BX	J.33
2453710000	LUF 10.00/04/90V 5.0SN BK BX	J.33
2453720000	LUF 10.00/05/90V 5.0SN BK BX	J.33
2453730000	LUF 10.00/06/90V 5.0SN BK BX	J.33
2453740000	LUF 10.00/07/90V 5.0SN BK BX	J.33
2453750000	LUF 10.00/08/90V 5.0SN BK BX	J.33
2453760000	LUF 10.00/09/90V 5.0SN BK BX	J.33
2453770000	LUF 10.00/10/90V 5.0SN BK BX	J.33
2453780000	LUF 10.00/11/90V 5.0SN BK BX	J.33
2453790000	LUF 10.00/12/90V 5.0SN BK BX	J.33
2454110000	SV-SMT 762IT/04/90MF4 2.6SN BK BX	K.57
2458950000	BLF 3.50/02/180 SN OR BX	E.52
2459060000	BLF 3.50/03/180 SN OR BX	E.52
2459070000	BLF 3.50/04/180 SN OR BX	E.52
2459080000	BLF 3.50/05/180 SN OR BX	E.52
2459090000	BLF 3.50/06/180 SN OR BX	E.52
2459100000	BLF 3.50/07/180 SN OR BX	E.52
2459110000	BLF 3.50/08/180 SN OR BX	E.52
2459120000	BLF 3.50/09/180 SN OR BX	E.52
2459130000	BLF 3.50/10/180 SN OR BX	E.52
2459140000	BLF 3.50/11/180 SN OR BX	E.52
2459150000	BLF 3.50/12/180 SN OR BX	E.52
2459160000	BLF 3.50/13/180 SN OR BX	E.52
2459170000	BLF 3.50/14/180 SN OR BX	E.52
2459180000	BLF 3.50/15/180 SN OR BX	E.52
2459190000	BLF 3.50/16/180 SN OR BX	E.52
2459200000	BLF 3.50/17/180 SN OR BX	E.52
2459210000	BLF 3.50/18/180 SN OR BX	E.52
2459220000	BLF 3.50/19/180 SN OR BX	E.52
2459230000	BLF 3.50/20/180 SN OR BX	E.52
2459240000	BLF 3.50/21/180 SN OR BX	E.52

Order No.	Type	Page
2459250000	BLF 3.50/22/180 SN OR BX	E.52
2459260000	BLF 3.50/23/180 SN OR BX	E.52
2459270000	BLF 3.50/24/180 SN OR BX	E.52
2459390000	BLF 3.50/02/180F SN OR BX	E.53
2459400000	BLF 3.50/03/180F SN OR BX	E.53
2459410000	BLF 3.50/04/180F SN OR BX	E.53
2459420000	BLF 3.50/05/180F SN OR BX	E.53
2459430000	BLF 3.50/06/180F SN OR BX	E.53
2459440000	BLF 3.50/07/180F SN OR BX	E.53
2459450000	BLF 3.50/08/180F SN OR BX	E.53
2459460000	BLF 3.50/09/180F SN OR BX	E.53
2459470000	BLF 3.50/10/180F SN OR BX	E.53
2459480000	BLF 3.50/11/180F SN OR BX	E.53
2459490000	BLF 3.50/12/180F SN OR BX	E.53
2459500000	BLF 3.50/13/180F SN OR BX	E.53
2459510000	BLF 3.50/14/180F SN OR BX	E.53
2459520000	BLF 3.50/15/180F SN OR BX	E.53
2459530000	BLF 3.50/16/180F SN OR BX	E.53
2459540000	BLF 3.50/17/180F SN OR BX	E.53
2459550000	BLF 3.50/18/180F SN OR BX	E.53
2459560000	BLF 3.50/19/180F SN OR BX	E.53
2459570000	BLF 3.50/20/180F SN OR BX	E.53
2459680000	BLF 3.50/02/180LZR SN OR BX	E.53
2459690000	BLF 3.50/03/180LZR SN OR BX	E.53
2459700000	BLF 3.50/04/180LZR SN OR BX	E.53
2459710000	BLF 3.50/05/180LZR SN OR BX	E.53
2459720000	BLF 3.50/06/180LZR SN OR BX	E.53
2459730000	BLF 3.50/07/180LZR SN OR BX	E.53
2459740000	BLF 3.50/08/180LZR SN OR BX	E.53
2459750000	BLF 3.50/09/180LZR SN OR BX	E.53
2459760000	BLF 3.50/10/180LZR SN OR BX	E.53
2459770000	BLF 3.50/11/180LZR SN OR BX	E.53
2459780000	BLF 3.50/12/180LZR SN OR BX	E.53
2459790000	BLF 3.50/13/180LZR SN OR BX	E.53
2459800000	BLF 3.50/14/180LZR SN OR BX	E.53
2459810000	BLF 3.50/15/180LZR SN OR BX	E.53
2459820000	BLF 3.50/16/180LZR SN OR BX	E.53
2459830000	BLF 3.50/24/180LZR SN OR BX	E.53

## 2460000000

2460150000	BLF 3.50/02/180FV SN OR BX	E.53
2460240000	BLF 3.50/04/180FV SN OR BX	E.53
2461060000	RJ45M RID 3.3N4Y6/TY	B.32
2461070000	RJ45M RID 3.3N4Y6/TY	B.29
2467670000	SC-SMT 3.81 KO WT BX	I.10

## 2470000000

24711390000	BL/0 3.50/10F CJC AU BK BX	E.62
2471520000	LLF 7.50/01/90V 5.0SN BK BX	J.26
2471530000	LLF 7.50/02/90V 5.0SN BK BX	J.27
2472090000	LLF 7.50/03/90V 5.0SN BK BX	J.27
2472100000	LLF 7.50/04/90V 5.0SN BK BX	J.27
2472110000	LLF 7.50/05/90V 5.0SN BK BX	J.27
2472120000	LLF 7.50/06/90V 5.0SN BK BX	J.27
2472130000	LLF	



Order No.	Type	Page
2499960000	SV-SMT 7.62HP/04/270SF 2.6SN BK BX	K.115
2499970000	SV-SMT 7.62HP/05/270SF 2.6SN BK BX	K.115

## 2500000000

2500460000	LUFS 10.00/03/90V 5.0SN BK BX	J.35
2500470000	LUFS 10.00/04/90V 5.0SN BK BX	J.35
2500480000	LUFS 10.00/05/90V 5.0SN BK BX	J.35
2500490000	LUFS 10.00/06/90V 5.0SN BK BX	J.35
2500500000	LUFS 10.00/07/90V 5.0SN BK BX	J.35
2500510000	LUFS 10.00/08/90V 5.0SN BK BX	J.35
2500520000	LUFS 10.00/09/90V 5.0SN BK BX	J.35
2500530000	LUFS 10.00/10/90V 5.0SN BK BX	J.35
2500540000	LUFS 10.00/11/90V 5.0SN BK BX	J.35
2500550000	LUFS 10.00/12/90V 5.0SN BK BX	J.35
2500560000	LUFS 10.00/01/90 5.0SN BK BX	J.35
2500570000	LUFS 15.00/03/90V 5.0SN BK BX	J.40
2500580000	LUFS 15.00/04/90V 5.0SN BK BX	J.40
2500590000	LUFS 15.00/05/90V 5.0SN BK BX	J.40
2500600000	LUFS 15.00/07/90V 5.0SN BK BX	J.40
2500610000	LUFS 15.00/08/90V 5.0SN BK BX	J.40
2500660000	LUFS 15.00/06/90V 5.0SN BK BX	J.40

## 2510000000

2514600000	RJ45C3 STV 2.7E4N RL	B.7
2516380000	RJ45C5 R1V 3.2N4G/Y TY	B.12

## 2520000000

2528950000	SV-SMT 7.62HP/02/90G SC/4 2.6SN BX	K.8
2528970000	SV-SMT 7.62HP/02/270G SC/4 2.6SN BX	K.14
2529000000	SV-SMT 7.62HP/02/90MF2 SC/4 2.6SN BX	K.10
2529010000	SV-SMT 7.62HP/02/270MF2 SC/4 2.6SN BX	K.16
2529030000	SV-SMT 7.62HP/02/90G SC/6 2.6SN BX	K.8
2529040000	SV-SMT 7.62HP/02/90G SC/8 2.6SN BX	K.8
2529050000	SV-SMT 7.62HP/03/90G SC/4 2.6SN BX	K.8
2529060000	SV-SMT 7.62HP/03/90G SC/6 2.6SN BX	K.8
2529070000	SV-SMT 7.62HP/03/90G SC/8 2.6SN BX	K.8
2529080000	SV-SMT 7.62HP/04/90G SC/4 2.6SN BX	K.8
2529090000	SV-SMT 7.62HP/04/90G SC/6 2.6SN BX	K.8
2529100000	SV-SMT 7.62HP/04/90G SC/8 2.6SN BX	K.8
2529110000	SV-SMT 7.62HP/05/90G SC/4 2.6SN BX	K.8
2529120000	SV-SMT 7.62HP/05/90G SC/6 2.6SN BX	K.8
2529130000	SV-SMT 7.62HP/05/90G SC/8 2.6SN BX	K.8
2529260000	SV-SMT 7.62HP/02/270G SC/6 2.6SN BX	K.14
2529270000	SV-SMT 7.62HP/02/270G SC/8 2.6SN BX	K.14
2529280000	SV-SMT 7.62HP/03/270G SC/4 2.6SN BX	K.14
2529290000	SV-SMT 7.62HP/03/270G SC/6 2.6SN BX	K.14
2529300000	SV-SMT 7.62HP/03/270G SC/8 2.6SN BX	K.14
2529310000	SV-SMT 7.62HP/04/270G SC/4 2.6SN BX	K.14
2529320000	SV-SMT 7.62HP/04/270G SC/6 2.6SN BX	K.14
2529330000	SV-SMT 7.62HP/04/270G SC/8 2.6SN BX	K.14
2529340000	SV-SMT 7.62HP/05/270G SC/4 2.6SN BX	K.14
2529350000	SV-SMT 7.62HP/05/270G SC/6 2.6SN BX	K.14
2529360000	SV-SMT 7.62HP/05/270G SC/8 2.6SN BX	K.14
2529370000	SV-SMT 7.62HP/05/270MF2 SC/6 2.6SN BX	K.16
2529380000	SV-SMT 7.62HP/05/270MF2 SC/8 2.6SN BX	K.16
2529390000	SV-SMT 7.62HP/05/270MF2 SC/8 2.6SN BX	K.16
2529400000	SV-SMT 7.62HP/03/270MF3 SC/8 2.6SN BX	K.17
2529410000	SV-SMT 7.62HP/03/270MF3 SC/6 2.6SN BX	K.17
2529420000	SV-SMT 7.62HP/03/270MF3 SC/8 2.6SN BX	K.17
2529430000	SV-SMT 7.62HP/04/270MF4 SC/4 2.6SN BX	K.17
2529440000	SV-SMT 7.62HP/04/270MF4 SC/6 2.6SN BX	K.17
2529470000	SV-SMT 7.62HP/04/270MF4 SC/8 2.6SN BX	K.17
2529480000	SV-SMT 7.62HP/05/270MF3 SC/4 2.6SN BX	K.17
2529490000	SV-SMT 7.62HP/05/270MF3 SC/6 2.6SN BX	K.17
2529500000	SV-SMT 7.62HP/05/270MF3 SC/8 2.6SN BX	K.17
2529510000	SV-SMT 7.62HP/05/270MF3 SC/8 2.6SN BX	K.17
2529520000	SV-SMT 7.62HP/05/270MF4 SC/6 2.6SN BX	K.17
2529530000	SV-SMT 7.62HP/05/270MF4 SC/8 2.6SN BX	K.17
2529540000	SV-SMT 7.62HP/02/270MF2 SC/4 2.6SN BX	K.18
2529550000	SV-SMT 7.62HP/02/270MF2 SC/6 2.6SN BX	K.18
2529560000	SV-SMT 7.62HP/02/270MF2 SC/8 2.6SN BX	K.18
2529570000	SV-SMT 7.62HP/03/270MF2 SC/4 2.6SN BX	K.18
2529580000	SV-SMT 7.62HP/03/270MF2 SC/6 2.6SN BX	K.18
2529590000	SV-SMT 7.62HP/03/270MF2 SC/8 2.6SN BX	K.18
2529600000	SV-SMT 7.62HP/03/270MF3 SC/4 2.6SN BX	K.19
2529610000	SV-SMT 7.62HP/03/270MF3 SC/6 2.6SN BX	K.19
2529620000	SV-SMT 7.62HP/03/270MF3 SC/8 2.6SN BX	K.19
2529630000	SV-SMT 7.62HP/04/270MF4 SC/4 2.6SN BX	K.19
2529640000	SV-SMT 7.62HP/04/270MF4 SC/6 2.6SN BX	K.19
2529650000	SV-SMT 7.62HP/04/270MF4 SC/8 2.6SN BX	K.19
2529660000	SV-SMT 7.62HP/05/270MF3 SC/4 2.6SN BX	K.19
2529670000	SV-SMT 7.62HP/05/270MF3 SC/6 2.6SN BX	K.19
2529680000	SV-SMT 7.62HP/05/270MF3 SC/8 2.6SN BX	K.19
2529690000	SV-SMT 7.62HP/05/270MF4 SC/4 2.6SN BX	K.19
2529700000	SV-SMT 7.62HP/05/270MF4 SC/6 2.6SN BX	K.19
2529710000	SV-SMT 7.62HP/05/270MF4 SC/8 2.6SN BX	K.19
2529720000	SV-SMT 7.62HP/02/90MF2 SC/6 2.6SN BX	K.10
2529730000	SV-SMT 7.62HP/02/90MF2 SC/8 2.6SN BX	K.10
2529740000	SV-SMT 7.62HP/03/90MF2 SC/4 2.6SN BX	K.10
2529750000	SV-SMT 7.62HP/03/90MF2 SC/6 2.6SN BX	K.10
2529760000	SV-SMT 7.62HP/03/90MF2 SC/8 2.6SN BX	K.10
2529770000	SV-SMT 7.62HP/03/90MF3 SC/6 2.6SN BX	K.11
2529780000	SV-SMT 7.62HP/03/90MF3 SC/8 2.6SN BX	K.11
2529790000	SV-SMT 7.62HP/03/90MF3 SC/8 2.6SN BX	K.11

Order No.	Type	Page
2529800000	SV-SMT 7.62HP/04/90MF4 SC/4 2.6SN BX	K.11
2529810000	SV-SMT 7.62HP/04/90MF4 SC/6 2.6SN BX	K.11
2529820000	SV-SMT 7.62HP/04/90MF4 SC/8 2.6SN BX	K.11
2529830000	SV-SMT 7.62HP/05/90MF3 SC/4 2.6SN BX	K.11
2529840000	SV-SMT 7.62HP/05/90MF3 SC/6 2.6SN BX	K.11
2529850000	SV-SMT 7.62HP/05/90MF3 SC/8 2.6SN BX	K.11
2529860000	SV-SMT 7.62HP/05/90MF4 SC/4 2.6SN BX	K.11
2529870000	SV-SMT 7.62HP/05/90MF4 SC/6 2.6SN BX	K.11
2529880000	SV-SMT 7.62HP/05/90MF4 SC/8 2.6SN BX	K.11
2529890000	SV-SMT 7.62HP/02/90MF2 SC/4 2.6SN BX	K.12
2529900000	SV-SMT 7.62HP/02/90MF2 SC/6 2.6SN BX	K.12
2529910000	SV-SMT 7.62HP/02/90MF2 SC/8 2.6SN BX	K.12
2529920000	SV-SMT 7.62HP/03/90MF2 SC/4 2.6SN BX	K.12
2529930000	SV-SMT 7.62HP/03/90MF2 SC/6 2.6SN BX	K.12
2529940000	SV-SMT 7.62HP/03/90MF2 SC/8 2.6SN BX	K.12
2529950000	SV-SMT 7.62HP/03/90MF3 SC/4 2.6SN BX	K.13
2529960000	SV-SMT 7.62HP/03/90MF3 SC/6 2.6SN BX	K.13
2529970000	SV-SMT 7.62HP/03/90MF3 SC/8 2.6SN BX	K.13
2529980000	SV-SMT 7.62HP/04/90MF4 SC/4 2.6SN BX	K.13
2529990000	SV-SMT 7.62HP/04/90MF4 SC/6 2.6SN BX	K.13

## 2530000000

2530000000	SV-SMT 7.62HP/04/90MF4 SC/8 2.6SN BX	K.13
2530010000	SV-SMT 7.62HP/05/90MF3 SC/4 2.6SN BX	K.13
2530020000	SV-SMT 7.62HP/05/90MF3 SC/6 2.6SN BX	K.13
2530030000	SV-SMT 7.62HP/05/90MF3 SC/8 2.6SN BX	K.13
2530040000	SV-SMT 7.62HP/05/90MF3 SC/4 2.6SN BX	K.13
2530050000	SV-SMT 7.62HP/05/90MF3 SC/6 2.6SN BX	K.13
2530060000	SV-SMT 7.62HP/05/90MF3 SC/8 2.6SN BX	K.13
2532826000	BLF 3.50/17/180LR SN OR BX	E.53
2532870000	BLF 3.50/18/180LR SN OR BX	E.53

## 2540000000

2544500000	RJ45G1 R1D2 3.3E4G/Y TY	B.35
2544510000	RJ45G1 R1D 3.3E4G/Y TY	B.35
2544950000	BUF 10.16T/04/180MF4 AG BK BX	K.73
2545800000	SV-SMT 7.62HP/02/90G 2.6SN BK RL	K.111
2545810000	SV-SMT 7.62HP/02/90SF 2.6SN BK RL	K.112
2545950000	SV-SMT 7.62HP/03/90SF 2.6SN BK RL	K.112
2545960000	SV-SMT 7.62HP/03/90SF 2.6SN BK RL	K.112
2545970000	SV-SMT 7.62HP/05/90SF 2.6SN BK RL	K.112
2546020000	SV-SMT 7.62HP/02/270SF 2.6SN BK RL	K.116
2546030000	SV-SMT 7.62HP/03/270SF 2.6SN BK RL	K.116
2546040000	SV-SMT 7.62HP/04/270SF 2.6SN BK RL	K.116
2546050000	SV-SMT 7.62HP/05/270SF 2.6SN BK RL	K.116
2546110000	SV-SMT 7.62HP/03/90G 2.6SN BK RL	K.111
2546120000	SV-SMT 7.62HP/04/90G 2.6SN BK RL	K.111
2546130000	SV-SMT 7.62HP/05/90G 2.6SN BK RL	K.111
2546140000	SV-SMT 7.62HP/02/270G 2.6SN BK RL	K.115
2546150000	SV-SMT 7.62HP/03/270G 2.6SN BK RL	K.115
2546160000	SV-SMT 7.62HP/04/270G 2.6SN BK RL	K.115
2546170000	SV-SMT 7.62HP/05/270G 2.6SN BK RL	K.115
2548870000	BVFL 7.62HP/02/180 SN BK BX	K.170
2548880000	BVFL 7.62HP/03/180 SN BK BX	K.170
2548890000	BVFL 7.62HP/04/180 SN BK BX	K.170
2549280000	BVFL 7.62HP/02/180F SN BK BX	K.171
2549300000	BVFL 7.62HP/02/180MF3 SN BK BX	K.172
2549310000	BVFL 7.62HP/02/180 BCF/04R SN BK BX	K.48
2549320000	BVFL 7.62HP/02/180MF2 BCF/04R SN BK BX	K.42
2549330000	BVFL 7.62HP/03/180F SN BK BX	K.171
2549350000	BVFL 7.62HP/03/180F SN BK BX	K.171
2549360000	BVFL 7.62HP/03/180MF2 SC/8 SN BK BX	K.173
2549370000	BVFL 7.62HP/05/180MF4 SC/8 SN BK BX	K.173
2549400000	BVFL 7.62HP/03/180 BCF/04R SN BK BX	K.38
2549410000	BVFL 7.62HP/03/180 BCF/06R SN BK BX	K.38
2549420000	BVFL 7.62HP/03/180 BCF/08R SN BK BX	K.38
2549430000	BVFL 7.62HP/04/180 BCF/08R SN BK BX	K.38
2549440000	BVFL 7.62HP/04/180 BCF/06R SN BK BX	K.38
2549450000	BVFL 7.62HP/05/180 BCF/04R SN BK BX	K.38
2549460000	BVFL 7.62HP/05/180MF3 BCF/04R SN BK BX	K.43
2549470000	BVFL 7.62HP/05/180MF3 BCF/06R SN BK BX	K.43
2549480000	BVFL 7.62HP/03/180MF3 BCF/06R SN BK BX	K.43
2549490000	BVFL 7.62HP/04/180MF4 BCF/06R SN BK BX	K.43
2549500000	BVFL 7.62HP/04/180MF4 BCF/08R SN BK BX	K.43
2549510000	BVFL 7.62HP/04/180MF4 BCF/08R SN BK BX	K.43
2549520000	BVFL 7.62HP/05/180MF4 BCF/04R SN BK BX	K.43
2549530000	BVFL 7.62HP/05/180MF4 BCF/06R SN BK BX	K.43
2549540000	BVFL 7.62HP/05/180MF4 BCF/08R SN BK BX	K.43
2549550000	BVFL 7.62HP/05/180MF4 BCF/06R SN BK BX	K.45
2549560000	BVFL 7.62HP/03/180MF3 BCF/06R SN BK BX	K.45
2549570000	BVFL 7.62HP/03/180MF3 BCF/08R SN BK BX	K.45
2549580000	BVFL 7.62HP/04/180MF4 BCF/08R SN BK BX	K.45
2549590000	BVFL 7.62HP/05/180MF4 BCF/04R SN BK BX	K.45
2549600000	BVFL 7.62HP/05/180MF4 BCF/06R SN BK BX	K.45
2549610000	BVFL 7.62HP/05/180MF4 BCF/08R SN BK BX	K.45

## 2550000000

2551900000	RJ45M R1D2 3.2N4G/Y RL	B.36
------------	------------------------	------

## 2560000000

2562150000	RJ45M R1V 1.9N4YG/YG RL	B.29
2562160000	RJ45G1 R1V 1.9N4YG/YG RL	B.28

Order No.	Type	Page
2562820000	RJ45C5 T1D 3.2E4G/Y TY	B.21
2562870000	RJ45C5 R1D 3.2E4G/Y RL	B.14
2562880000	RJ45C5 T1U 2.8E4G/Y TY	B.23
2562890000	RJ45C3 STU DE4G/Y RL	B.11
2562900000	RJ45C5 T1D 3.3E4N TY	B.21
2562910000	RJ45C5 R1D 3.3E4N RL	B.15
2562920000	RJ45C5 T1U 2.8E4N TY	B.23
2562930000	RJ45C5 R1U 2.8E4N RL	B.16
2562940000	RJ45C3 STU DE4N RL	B.11
2562950000	RJ45C5 R1U 2.8N4G/Y RL	B.17
2562960000	RJ45C5 T1V 3.2N4G/Y TY	B.19
2562970000	RJ45C5 R1V 3.2N4N RL	B.13

Order No.	Type	Page
2628980000	BVFL 7.62HP/05/180MF3 BCF/08R SN BK BX	K.43
2629020000	BVFL 7.62HP/02/180MSF2 BCF/08R SN BK BX	K.44
2629030000	BVFL 7.62HP/02/180MSF2 BCF/08R SN BK BX	K.44
2629060000	BVFL 7.62HP/03/180MSF2 BCF/04R SN BK BX	K.44
2629070000	BVFL 7.62HP/03/180MSF2 BCF/08R SN BK BX	K.44
2629080000	BVFL 7.62HP/03/180MSF2 BCF/08R SN BK BX	K.44
2629120000	BVFL 7.62HP/04/180MSF2 BCF/04R SN BK BX	K.44
2629130000	BVFL 7.62HP/04/180MSF2 BCF/08R SN BK BX	K.44
2629140000	BVFL 7.62HP/04/180MSF2 BCF/04R SN BK BX	K.44
2629180000	BVFL 7.62HP/05/180MSF2 BCF/04R SN BK BX	K.44
2629190000	BVFL 7.62HP/05/180MSF2 BCF/08R SN BK BX	K.44
2629200000	BVFL 7.62HP/05/180MSF2 BCF/08R SN BK BX	K.44
2629240000	BVFL 7.62HP/04/180MSF3 BCF/04R SN BK BX	K.45
2629250000	BVFL 7.62HP/04/180MSF3 BCF/08R SN BK BX	K.45
2629260000	BVFL 7.62HP/04/180MSF3 BCF/08R SN BK BX	K.45
2629300000	BVFL 7.62HP/05/180MSF3 BCF/04R SN BK BX	K.45
2629310000	BVFL 7.62HP/05/180MSF3 BCF/08R SN BK BX	K.45
2629320000	BVFL 7.62HP/05/180MSF3 BCF/08R SN BK BX	K.45
2629360000	SL 7.62IT/05/90MF2 3.2SN BK BX	K.52
2629480000	SL 7.62IT/06/90MF2 3.2SN BK BX	K.52
2629490000	SL 7.62IT/04/90MF3 3.2SN BK BX SO	K.53
2629500000	SL 7.62IT/06/90MF4 3.2SN BK BX SO	K.53
2629690000	BLZ 7.62IT/05/180MF2 SN BK BX	K.54
2629730000	SU 10.16IT/04/90MF3 3.5AG BK BX SO	K.67
2629740000	BLZ 7.62IT/06/180MF2 SN BK BX	K.54
2629750000	BLZ 7.62IT/04/180MF3 SN BK BX	K.55
2629820000	BVF 7.62HP/06/180MF2 SN BK BX	K.166

## 2630000000

2630190000	SU 10.16IT/04/270MF3 3.5AG BK BX SO	K.69
2630260000	SVFL 7.62HP/02/180MF2 SN BK BX	K.156
2630270000	BVF 7.62HP/06/180MF3 SN BK BX	K.167
2630320000	BVF 7.62HP/06/180MSF3 SN BK BX	K.169
2630420000	SVFL 7.62HP/03/180MF2 SN BK BX	K.156
2630430000	SVFL 7.62HP/04/180MF2 SN BK BX	K.156
2630440000	SVFL 7.62HP/05/180MF2 SN BK BX	K.156
2630450000	SVFL 7.62HP/03/180MF3 SN BK BX	K.157
2630460000	SVFL 7.62HP/05/180MF3 SN BK BX	K.157
2630470000	SVFL 7.62HP/04/180MF4 SN BK BX	K.157
2630480000	SVFL 7.62HP/05/180MF4 SN BK BX	K.157
2630700000	BVFL 7.62HP/04/180MF2 SN BK BX	K.172
2630710000	BVFL 7.62HP/05/180MF2 SN BK BX	K.172
2630720000	BVFL 7.62HP/06/180MF2 SN BK BX	K.172
2630730000	BVFL 7.62HP/06/180MF3 SN BK BX	K.173
2630740000	BVFL 7.62HP/04/180MF4 SN BK BX	K.173

## 4010000000

4010870000	PF RS 100 GR 2000MM A.1	N.50
4011200000	LKSC M2.9x13VZ	N.46
4011200000	LKSC M2.9x13VZ	N.48
4011200000	LKSC M2.9x13VZ	N.49
4019420000	PTSC KB40X14	N.50

## 4020000000

4027750000	PF RS 45 GR 2000MM	N.46
------------	--------------------	------

## 4050000000

4051810000	PF RS 90 GR 2000MM	N.49
4053240000	PF RS 90 OR 2000MM	N.49

## 4060000000

4060540000	SMSE 1 MSD ZB	N.40
------------	---------------	------

## 4140000000

4144870000	PF RS 100 OR 2000MM A.1	N.50
4148400000	PF RS 100 OR 155.5 MM	N.50

## 4150000000

4157440000	PF RS 80 OR 2000MM	N.48
------------	--------------------	------

## 4160000000

4167150000	ADP 5	N.48
4167160000	ADP 6	N.48
4169320000	ADP 10	N.50
4169330000	ADP 11	N.50

## 4180000000

4183130000	PF RS 80 GR 2000MM	N.48
------------	--------------------	------

## 4280000000

4286620000	SMSE MSA ZB	N.40
------------	-------------	------

## 4340000000

4340430000	PF RS 45 OR 2000MM	N.46
------------	--------------------	------

## 8140000000

8140860000	AP 45/RE DI GR	N.46
------------	----------------	------

Order No.	Type	Page
8140870000	AP 45/LI DI GR	N.46
8140880000	PF RS 45 GR 1000MM	N.46
8143900000	AP 45/RE GR 2025	N.46
8143910000	AP 45/LI GR 2025	N.46

## 8150000000

8156200000	AP RF 80 RE 2025	N.48
8156210000	AP RF 80 LI 2025	N.48

## 8320000000

8320300000	AP 80 GR	N.48
------------	----------	------

## 8380000000

8389030000	AP MCZ1.5 1674	N.41
------------	----------------	------

## 8850000000

8857560000	MCZ 5	N.41
------------	-------	------

## 9000000000

9004530000	DW RSV 1.6	H.14
9004530000	DW RSV 1.6	L.21
9004590000	H0.5/14S W	G.46
9004590000	H0.5/14S W	G.48
9004590000	H0.5/14S W	G.90
9004590000	H0.5/14S W	G.94
9004590000	H0.5/14S W	G.102
9004590000	H0.5/14S W	G.124
9004590000	H0.5/14S W	G.126
9004590000	H0.5/14S W	G.128
9004590000	H0.5/14S W	G.130
9005990000	PZ 1.5	E.12
9005990000	PZ 1.5	E.18
9005990000	PZ 1.5	E.56
9005990000	PZ 1.5	E.58
9005990000	PZ 1.5	E.60
9005990000	PZ 1.5	E.62
9005990000	PZ 1.5	F.54
9005990000	PZ 1.5	F.56
9008320000	SDS 0.5X3.0X80	L.22
9008320000	SDS 0.5X3.0X80	J.26
9008320000	SDS 0.5X3.0X80	J.27
9008320000	SDS 0.5X3.0X80	K.94
9008320000	SDS 0.5X3.0X80	L.10
9008320000	SDS 0.5X3.0X80	M.5
9008320000	SDS 0.5X3.0X80	N.53
9008330000	SDS 0.6X3.5X100	C.18
9008330000	SDS 0.6X3.5X100	C.20
9008330000	SDS 0.6X3.5X100	C.22
9008330000	SDS 0.6X3.5X100	C.24
9008330000	SDS 0.6X3.5X100	C.26
9008330000	SDS 0.6X3.5X100	C.28
9008330000	SDS 0.6X3.5X100	C.30
9008330000	SDS 0.6X3.5X100	C.32
9008330000	SDS 0.6X3.5X100	C.36
9008330000	SDS 0.6X3.5X100	C.38
9008330000	SDS 0.6X3.5X100	C.40
9008330000	SDS 0.6X3.5X100	C.42
9008330000	SDS 0.6X3.5X100	C.90
9008330000	SDS 0.6X3.5X100	C.92
9008330000	SDS 0.6X3.5X100	C.96
9008330000	SDS 0.6X3.5X100	C.98
9008330000	SDS 0.6X3.5X100	C.100
9008330000	SDS 0.6X3.5X100	C.102
9008330000	SDS 0.6X3.5X100	G.40
9008330000	SDS 0.6X3.5X100	G.42
9008330000	SDS 0.6X3.5X100	G.44
9008330000	SDS 0.6X3.5X100	G.46
9008330000	SDS 0.6X3.5X100	G.48
9008330000	SDS 0.6X3.5X100	G.86
9008330000	SDS 0.6X3.5X100	G.88
9008330000	SDS 0.6X3.5X100	G.90
9008330000	SDS 0.6X3.5X100	G.98
9008330000	SDS 0.6X3.5X100	G.100
9008330000	SDS 0.6X3.5X100	G.102
9008330000	SDS 0.6X3.5X100	G.104
9008330000	SDS 0.6X3.5X100	G.106
9008330000	SDS 0.6X3.5X100	G.108
9008330000	SDS 0.6X3.5X100	G.110
9008330000	SDS 0.6X3.5X100	G.112
9008330000	SDS 0.6X3.5X100	G.114
9008330000	SDS 0.6X3.5X100	G.118
9008330000	SDS 0.6X3.5X100	G.120
9008330000	SDS 0.6X3.5X100	G.122
9008330000	SDS 0.6X3.5X100	G.126
9008330000	SDS 0.6X3.5X100	G.128
9008330000	SDS 0.6X3.5X100	G.130
9008330000	SDS 0.6X3.5X100	L.22
9008330000	SDS 0.6X3.5X100	K.40
9008330000	SDS 0.6X3.5X100	K.42

Order No.	Type	Page
9008330000	SDS 0.6X3.5X100	K.44
9008330000	SDS 0.6X3.5X100	K.54
9008330000	SDS 0.6X3.5X100	K.88
9008330000	SDS 0.6X3.5X100	K.90
9008330000	SDS 0.6X3.5X100	K.92
9008330000	SDS 0.6X3.5X100	K.148
9008330000	SDS 0.6X3.5X100	K.170
9008330000	SDS 0.6X3.5X100	K.172
9008330000	SDS 0.6X3.5X100	M.5
9008330000	SDS 0.6X3.5X100	N.53
9008340000	SDS 0.8X4.0X100	C.34
9008340000	SDS 0.8X4.0X100	C.35
9008340000	SDS 0.8X4.0X100	L.22
9008340000	SDS 0.8X4.0X100	J.16
9008340000	SDS 0.8X4.0X100	J.28
9008340000	SDS 0.8X4.0X100	J.29
9008340000	SDS 0.8X4.0X100	C.34
9008340000	SDS 0.8X4.0X100	C.35
9008340000	SDS 0.8X4.0X100	L.22
9008340000	SDS 0.8X4.0X100	J.16
9008340000	SDS 0.8X4.0X100	J.28
9008340000	SDS 0.8X4.0X100	J.29
9008340000	SDS 0.8X4.0X100	M.5
9008340000	SDS 0.8X4.0X100	N.53
9008340000	SDS 0.8X4.0X100	C.34
9008340000	SDS 0.8X4.0X100	C.35
9008340000	SDS 0.8X4.0X100	L.22
9008340000	SDS 0.8X4.0X100	J.16
9008340000	SDS 0.8X4.0X100	J.28
9008340000	SDS 0.8X4.0X100	J.29
9008340000	SDS 0.8X4.0X100	M.5
9008340000	SDS 0.8X4.0X100	N.53
9008350000	SDS 1.0X5.5X150	L.22
9008350000	SDS 1.0X5.5X150	J.18
9008350000	SDS 1.0X5.5X150	J.19
9008350000	SDS 1.0X5.5X150	J.20
9008350000	SDS 1.0X5.5X150	J.21
9008350000	SDS 1.0X5.5X150	M.5
9008350000	SDS 1.0X5.5X150	N.53
9008370000	SDS 0.4X2.5X75	C.14
9008370000	SDS 0.4X2.5X75	C.15
9008370000	SDS 0.4X2.5X75	C.16
9008370000	SDS 0.4X2.5X75	C.17
9008370000	SDS 0.4X2.5X75	C.48
9008370000	SDS 0.4X2.5X75	C.50
9008370000	SDS 0.4X2.5X75	C.52
9008370000	SDS 0.4X2.5X75	C.54
9008370000	SDS 0.4X2.5X75	C.56
9008370000	SDS 0.4X2.5X75	C.58
9008370000	SDS 0.4X2.5X75	C.60
9008370000	SDS 0.4X2.5X75	C.62
9008370000	SDS 0.4X2.5X75	C.64
9008370000	SDS 0.4X2.5X75	C.66
9008370000	SDS 0.4X2.5X75	C.68
9008370000	SDS 0.4X2.5X75	C.70
9008370000	SDS 0.4X2.5X75	C.72
9008370000	SDS 0.4X2.5X75	C.74
9008370000	SDS 0.4X2.5X75	C.76
9008370000	SDS 0.4X2.5X75	C.78
9008370000	SDS 0.4X2.5X75	C.80
9008370000	SDS 0.4X2.5X75	C.82
9008370000	SDS 0.4X2.5X75	C.84
9008370000	SDS 0.4X2.5X75	C.86
9008370000	SDS 0.4X2.5X75	C.88
9008370000	SDS 0.4X2.5X75	C.94
9008370000	SDS 0.4X2.5X75	E.48
9008370000	SDS 0.4X2.5X75	E.50
9008370000	SDS 0.4X2.5X75	E.54
9008370000	SDS 0.4X2.5X75	E.56
9008370000	SDS 0.4X2.5X75	E.58
9008370000	SDS 0.4X2.5X75	E.60
9008370000	SDS 0.4X2.5X75	E.62
9008370000	SDS 0.4X2.5X75	F.44
9008370000	SDS 0.4X2.5X75	F.46
9008370000	SDS 0.4X2.5X75	F.48
9008370000	SDS 0.4X2.5X75	F.50
9008370000	SDS 0.4X2.5X75	F.52
9008		

Order No.	Type	Page
9008480000	SDK PH1	K.134
9008480000	SDK PH1	K.136
9008480000	SDK PH1	K.138
9008480000	SDK PH1	K.139
9008480000	SDK PH1	K.140
9008480000	SDK PH1	K.158
9008480000	SDK PH1	K.160
9008480000	SDK PH1	K.162
9008480000	SDK PH1	M.5
9008480000	SDK PH1	N.53
9008490000	SDK PH2	I.22
9008490000	SDK PH2	M.5
9008490000	SDK PH2	N.53
9008500000	SDK PH3	I.22
9008500000	SDK PH3	M.5
9008500000	SDK PH3	N.53
9008530000	SDK PZ1	C.34
9008530000	SDK PZ1	C.35
9008530000	SDK PZ1	G.40
9008530000	SDK PZ1	G.42
9008530000	SDK PZ1	G.44
9008530000	SDK PZ1	G.104
9008530000	SDK PZ1	G.106
9008530000	SDK PZ1	G.108
9008530000	SDK PZ1	G.110
9008530000	SDK PZ1	I.22
9008530000	SDK PZ1	J.16
9008530000	SDK PZ1	M.5
9008530000	SDK PZ1	N.53
9008540000	SDK PZ2	I.22
9008540000	SDK PZ2	J.18
9008540000	SDK PZ2	J.19
9008540000	SDK PZ2	J.20
9008540000	SDK PZ2	J.21
9008540000	SDK PZ2	J.22
9008540000	SDK PZ2	J.24
9008540000	SDK PZ2	K.70
9008540000	SDK PZ2	K.196
9008540000	SDK PZ2	K.198
9008540000	SDK PZ2	M.5
9008540000	SDK PZ2	N.53
9008550000	SDK PZ3	I.22
9008550000	SDK PZ3	M.5
9008550000	SDK PZ3	N.53
9008890000	SDIK PZ2	J.18
9008890000	SDIK PZ2	J.19
9008890000	SDIK PZ2	J.20
9008890000	SDIK PZ2	J.21
9008890000	SDIK PZ2	J.22
9008890000	SDIK PZ2	J.24
9008890000	SDIK PZ2	K.70
9008890000	SDIK PZ2	K.196
9008890000	SDIK PZ2	K.198
9008910000	SDIS 1.0X4.5X125	I.22
9008910000	SDIS 1.0X4.5X125	M.5
9008910000	SDIS 1.0X4.5X125	N.53
9009010000	SDS 1.2X6.5X150	J.22
9009010000	SDS 1.2X6.5X150	J.24
9009010000	SDS 1.2X6.5X150	M.5
9009010000	SDS 1.2X6.5X150	N.53
9009020000	SDS 0.8X4.5X125	I.22
9009020000	SDS 0.8X4.5X125	K.32
9009020000	SDS 0.8X4.5X125	K.34
9009020000	SDS 0.8X4.5X125	K.36
9009020000	SDS 0.8X4.5X125	K.38
9009020000	SDS 0.8X4.5X125	K.64
9009020000	SDS 0.8X4.5X125	K.72
9009020000	SDS 0.8X4.5X125	K.74
9009020000	SDS 0.8X4.5X125	K.132
9009020000	SDS 0.8X4.5X125	K.134
9009020000	SDS 0.8X4.5X125	K.136
9009020000	SDS 0.8X4.5X125	K.138
9009020000	SDS 0.8X4.5X125	K.139
9009020000	SDS 0.8X4.5X125	K.140
9009020000	SDS 0.8X4.5X125	K.142
9009020000	SDS 0.8X4.5X125	K.144
9009020000	SDS 0.8X4.5X125	K.146
9009020000	SDS 0.8X4.5X125	K.150
9009020000	SDS 0.8X4.5X125	K.152
9009020000	SDS 0.8X4.5X125	K.154
9009020000	SDS 0.8X4.5X125	K.158
9009020000	SDS 0.8X4.5X125	K.160
9009020000	SDS 0.8X4.5X125	K.162
9009020000	SDS 0.8X4.5X125	K.164
9009020000	SDS 0.8X4.5X125	K.166
9009020000	SDS 0.8X4.5X125	K.168
9009020000	SDS 0.8X4.5X125	K.200
9009020000	SDS 0.8X4.5X125	M.5
9009020000	SDS 0.8X4.5X125	N.53
9009030000	SDS 0.4X2.5X75	C.14
9009030000	SDS 0.4X2.5X75	C.15
9009030000	SDS 0.4X2.5X75	C.16
9009030000	SDS 0.4X2.5X75	C.17
9009030000	SDS 0.4X2.5X75	C.48
9009030000	SDS 0.4X2.5X75	C.50
9009030000	SDS 0.4X2.5X75	C.52
9009030000	SDS 0.4X2.5X75	C.54
9009030000	SDS 0.4X2.5X75	C.56

Order No.	Type	Page
9009030000	SDS 0.4X2.5X75	C.58
9009030000	SDS 0.4X2.5X75	C.60
9009030000	SDS 0.4X2.5X75	C.62
9009030000	SDS 0.4X2.5X75	C.64
9009030000	SDS 0.4X2.5X75	C.66
9009030000	SDS 0.4X2.5X75	C.68
9009030000	SDS 0.4X2.5X75	C.70
9009030000	SDS 0.4X2.5X75	C.72
9009030000	SDS 0.4X2.5X75	C.74
9009030000	SDS 0.4X2.5X75	C.76
9009030000	SDS 0.4X2.5X75	C.78
9009030000	SDS 0.4X2.5X75	C.80
9009030000	SDS 0.4X2.5X75	C.82
9009030000	SDS 0.4X2.5X75	C.84
9009030000	SDS 0.4X2.5X75	C.86
9009030000	SDS 0.4X2.5X75	C.88
9009030000	SDS 0.4X2.5X75	C.94
9009030000	SDS 0.4X2.5X75	E.12
9009030000	SDS 0.4X2.5X75	E.18
9009030000	SDS 0.4X2.5X75	E.48
9009030000	SDS 0.4X2.5X75	E.50
9009030000	SDS 0.4X2.5X75	E.54
9009030000	SDS 0.4X2.5X75	E.56
9009030000	SDS 0.4X2.5X75	E.58
9009030000	SDS 0.4X2.5X75	E.60
9009030000	SDS 0.4X2.5X75	E.62
9009030000	SDS 0.4X2.5X75	F.44
9009030000	SDS 0.4X2.5X75	F.46
9009030000	SDS 0.4X2.5X75	F.48
9009030000	SDS 0.4X2.5X75	F.50
9009030000	SDS 0.4X2.5X75	F.52
9009030000	SDS 0.4X2.5X75	F.54
9009030000	SDS 0.4X2.5X75	F.56
9009030000	SDS 0.4X2.5X75	I.22
9009030000	SDS 0.4X2.5X75	L.10
9009030000	SDS 0.4X2.5X75	M.5
9009030000	SDS 0.4X2.5X75	N.53
<b>9010000000</b>		
9011460000	PZ 6/5	E.12
9011460000	PZ 6/5	E.18
9011460000	PZ 6/5	E.56
9011460000	PZ 6/5	E.58
9011460000	PZ 6/5	E.60
9011460000	PZ 6/5	E.62
9011460000	PZ 6/5	F.54
9011460000	PZ 6/5	F.56
9011460000	PZ 6/5	K.32
9011460000	PZ 6/5	K.34
9011460000	PZ 6/5	K.36
9011460000	PZ 6/5	K.38
9011460000	PZ 6/5	K.40
9011460000	PZ 6/5	K.42
9011460000	PZ 6/5	K.44
9011460000	PZ 6/5	K.94
9011460000	PZ 6/5	K.142
9011460000	PZ 6/5	K.144
9011460000	PZ 6/5	K.146
9011460000	PZ 6/5	K.148
9011460000	PZ 6/5	K.150
9011460000	PZ 6/5	K.152
9011460000	PZ 6/5	K.154
9011460000	PZ 6/5	K.164
9011460000	PZ 6/5	K.166
9011460000	PZ 6/5	K.168
9011460000	PZ 6/5	K.170
9011460000	PZ 6/5	K.172
9011460000	PZ 6/5	L.10
9013090000	HTF 28	120
9013400000	HTF 63	120
9013550000	HTF RSV 12	120
9013560000	HTF RSV 16 WI	H.14
9013560000	HTF RSV 16 WI	120
9014140000	HTF DFF	G.132
9014140000	HTF DFF	120
9018560000	H1,0/14S R	G.46
9018560000	H1,0/14S R	G.48
9018560000	H1,0/14S R	G.102
9018560000	H1,0/14S R	G.124
9018560000	H1,0/14S R	G.126
9018560000	H1,0/14S R	G.128
9018560000	H1,0/14S R	G.130
<b>9020000000</b>		
9025240000	H1,5/14S SW	G.46
9025240000	H1,5/14S SW	G.48
9025240000	H1,5/14S SW	G.90
9025240000	H1,5/14S SW	G.94
9025240000	H1,5/14S SW	G.102
9025240000	H1,5/14S SW	G.124
9025240000	H1,5/14S SW	G.126
9025240000	H1,5/14S SW	G.128
9025240000	H1,5/14S SW	G.130
<b>9990000000</b>		
9994130000	LM 5.08/04/90 3.5SN DR BX	C.22

Order No.	Type	Page
9994140000	LM 5.08/05/90 3.5SN DR BX	C.22
9994150000	LM 5.08/06/90 3.5SN DR BX	C.22
9994160000	LM 5.08/07/90 3.5SN DR BX	C.22
9994170000	LM 5.08/08/90 3.5SN DR BX	C.22
9994180000	LM 5.08/09/90 3.5SN DR BX	C.22
9994190000	LM 5.08/10/90 3.5SN DR BX	C.22
9994200000	LM 5.08/11/90 3.5SN DR BX	C.22
9994210000	LM 5.08/12/90 3.5SN DR BX	C.22
9994220000	LM 5.08/13/90 3.5SN DR BX	C.22
9994230000	LM 5.08/14/90 3.5SN DR BX	C.22
9994240000	LM 5.08/15/90 3.5SN DR BX	C.22
9994250000	LM 5.08/16/90 3.5SN DR BX	C.22
9994260000	LM 5.08/17/90 3.5SN DR BX	C.22
9994270000	LM 5.08/18/90 3.5SN DR BX	C.22
9994280000	LM 5.08/19/90 3.5SN DR BX	C.22
9994290000	LM 5.08/20/90 3.5SN DR BX	C.22
9994300000	LM 5.08/21/90 3.5SN DR BX	C.22
9994310000	LM 5.08/22/90 3.5SN DR BX	C.22
9994320000	LM 5.08/23/90 3.5SN DR BX	C.22
9994330000	LM 5.08/24/90 3.5SN DR BX	C.22
9994550000	LM 5.08/04/135 3.5SN DR BX	C.23
9994560000	LM 5.08/05/135 3.5SN DR BX	C.23
9994570000	LM 5.08/06/135 3.5SN DR BX	C.23
9994580000	LM 5.08/07/135 3.5SN DR BX	C.23
9994590000	LM 5.08/08/135 3.5SN DR BX	C.23
9994600000	LM 5.08/09/135 3.5SN DR BX	C.23
9994610000	LM 5.08/10/135 3.5SN DR BX	C.23
9994620000	LM 5.08/11/135 3.5SN DR BX	C.23
9994630000	LM 5.08/12/135 3.5SN DR BX	C.23
9994640000	LM 5.08/13/135 3.5SN DR BX	C.23
9994650000	LM 5.08/14/135 3.5SN DR BX	C.23
9994660000	LM 5.08/15/135 3.5SN DR BX	C.23
9994670000	LM 5.08/16/135 3.5SN DR BX	C.23
9994680000	LM 5.08/17/135 3.5SN DR BX	C.23
9994690000	LM 5.08/18/135 3.5SN DR BX	C.23
9994700000	LM 5.08/19/135 3.5SN DR BX	C.23
9994710000	LM 5.08/20/135 3.5SN DR BX	C.23
9994720000	LM 5.08/21/135 3.5SN DR BX	C.23
9994730000	LM 5.08/22/135 3.5SN DR BX	C.23
9994740000	LM 5.08/23/135 3.5SN DR BX	C.23
9994750000	LM 5.08/24/135 3.5SN DR BX	C.23
9994970000	LM 5.08/04/180 3.5SN DR BX	C.23
9994980000	LM 5.08/05/180 3.5SN DR BX	C.23
9994990000	LM 5.08/06/180 3.5SN DR BX	C.23
9995000000	LM 5.08/07/180 3.5SN DR BX	C.23
9995010000	LM 5.08/08/180 3.5SN DR BX	C.23
9995020000	LM 5.08/09/180 3.5SN DR BX	C.23
9995030000	LM 5.08/10/180 3.5SN DR BX	C.23
9995040000	LM 5.08/11/180 3.5SN DR BX	C.23
9995050000	LM 5.08/12/180 3.5SN DR BX	C.23
9995060000	LM 5.08/13/180 3.5SN DR BX	C.23
9995070000	LM 5.08/14/180 3.5SN DR BX	C.23
9995080000	LM 5.08/15/180 3.5SN DR BX	C.23
9995090000	LM 5.08/16/180 3.5SN DR BX	C.23
9995100000	LM 5.08/17/180 3.5SN DR BX	C.23
9995110000	LM 5.08/18/180 3.5SN DR BX	C.23
9995120000	LM 5.08/19/180 3.5SN DR BX	C.23
9995130000	LM 5.08/20/180 3.5SN DR BX	C.23
9995140000	LM 5.08/21/180 3.5SN DR BX	C.23
9995150000	LM 5.08/22/180 3.5SN DR BX	C.23
9995210000	LM 5.08/23/180 3.5SN DR BX	C.23
9995220000	LM 5.08/24/180 3.5SN DR BX	C.23

# Addresses worldwide

Let's connect.

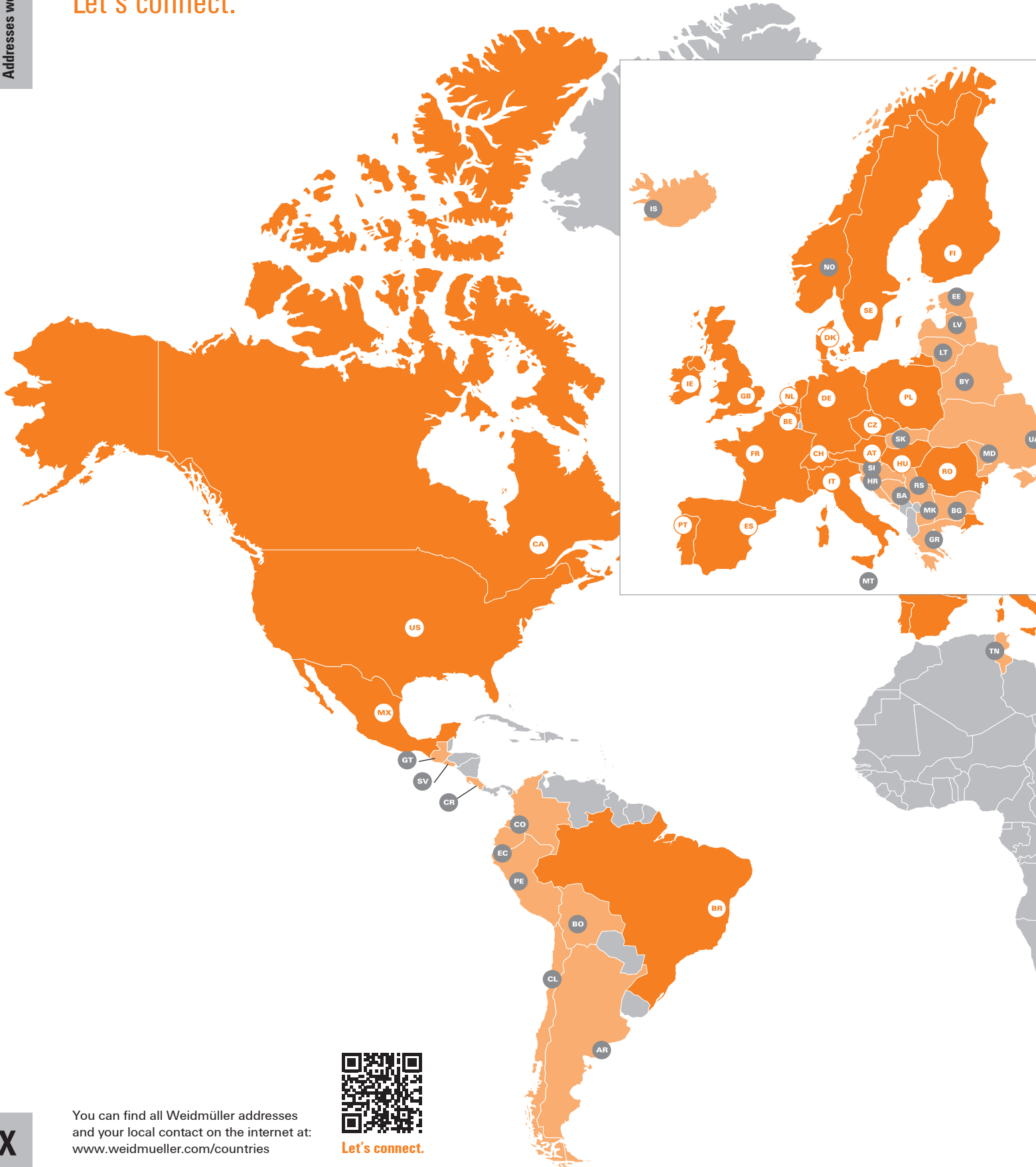

You can find all Weidmüller addresses and your local contact on the internet at: [www.weidmueller.com/countries](http://www.weidmueller.com/countries)



Let's connect.

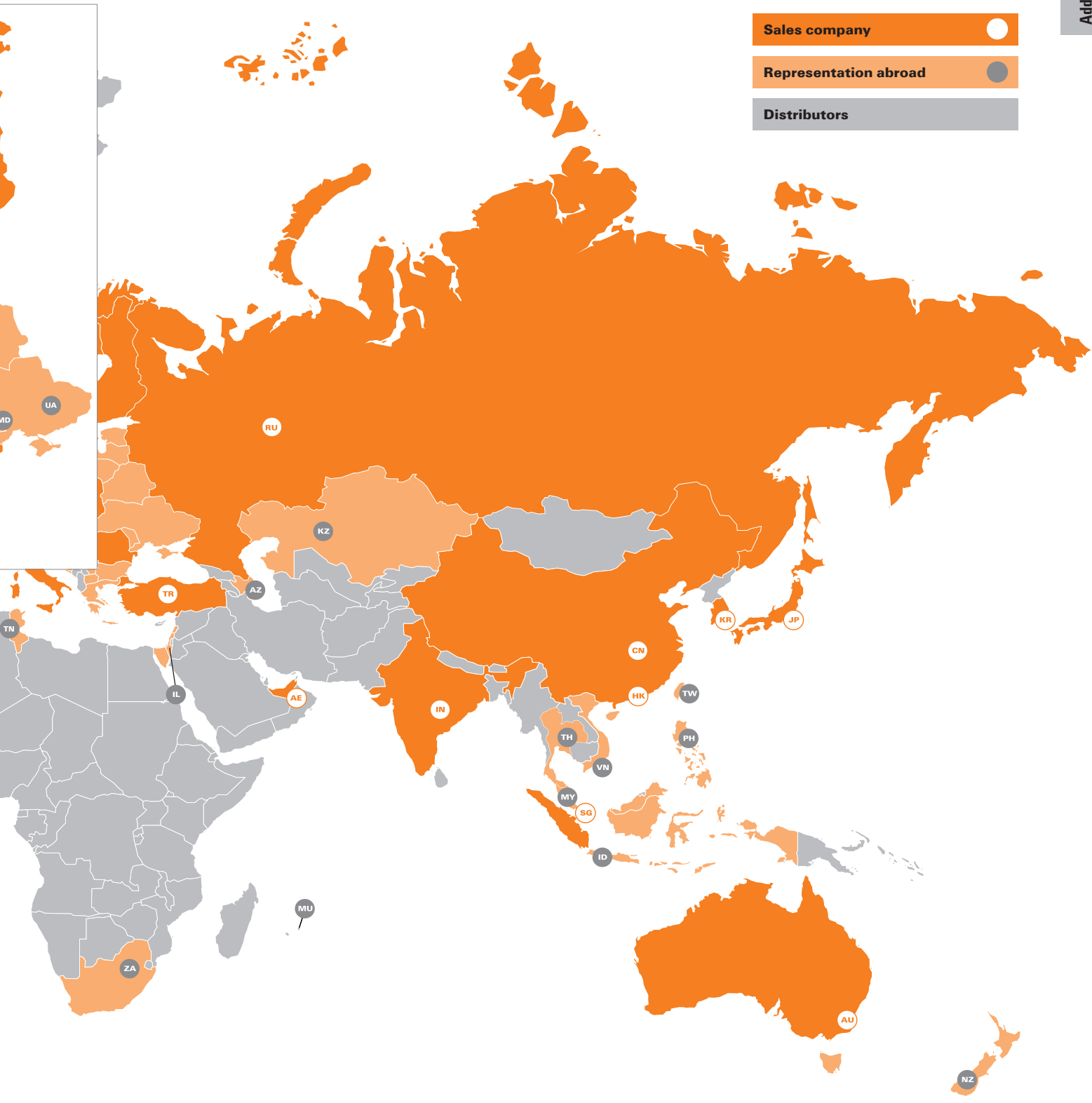





We cannot guarantee that there are no mistakes in the publications or software provided by us to the customer for the purpose of making orders. We try our best to quickly correct errors in our printed media.

All orders are based on our general terms of delivery, which can be reviewed on the websites of our group companies where you place your order. On demand we can also send the general terms of delivery to you.

X





## Weidmüller – Your partner in Industrial Connectivity

As experienced experts we support our customers and partners around the world with products, solutions and services in the industrial environment of power, signal and data. We are at home in their industries and markets and know the technological challenges of tomorrow. We are therefore continuously developing innovative, sustainable and useful solutions for their individual needs. Together we set standards in Industrial Connectivity.

Weidmüller Interface GmbH & Co. KG  
Klingenbergstraße 16  
32758 Detmold, Germany  
T +49 5231 14-0  
F +49 5231 14-292083  
[www.weidmueller.com](http://www.weidmueller.com)

Personal support can  
be found on our website:  
[www.weidmueller.com/contact](http://www.weidmueller.com/contact)

Made in Germany



Order number: 2596870000/02/2019/SMR