

**Complete Range
Sensor Systems**

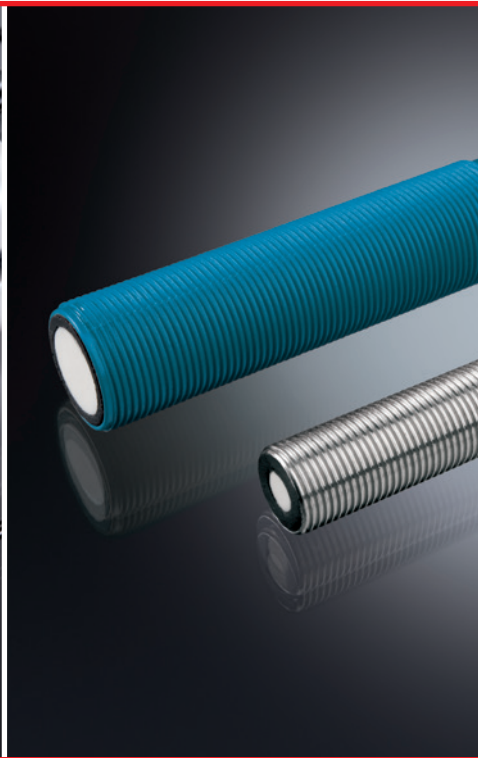

BERNSTEIN AG

A Success Story



Safety for man and machine

BERNSTEIN AG ranks among the world's leading providers of industrial **safety technology**. With our comprehensive range of **switches, sensors, enclosures, suspension systems** and other components for industrial applications, we offer our customers effective and versatile solutions.

In-depth market knowledge, the close proximity to end users as well as years of experience in mechanical engineering and electronics are reflected down to the last detail in our products.

By conforming to international safety guidelines, our products perfectly integrate in individual system solutions. Our focus is complete commitment to safety for man, machine and industrial processes.

Our expertise for your safety

With sound application expertise we support our customers from all branches of industry in the planning and implementation of systems designed to meet stringent safety requirements. In addition to classic **plant and machine construction**, we look after customers in the **lift construction, automotive, agriculture, conveyor construction, automation engineering, wood-working, renewable energy, medical technology industries, AS-Interface** and **ATEX**.



**Our knowledge
is your success**

Our philosophy

Customer Satisfaction is our number one priority. For us, **Quality** is more than making a good product, it's about designing them to perfectly match ALL of your needs.

Customized Solutions are fully integrated into our business and form part of our everyday working life. Employees are treated as our greatest asset as they are responsible for the quality and success of our products. All **BERNSTEIN TEAM** members are trained and educated to the highest possible standard so they can deliver **"Best in Class" Service and Support**. The BERNSTEIN TEAM will support you both personally and professionally, working together we will provide you with the **best Safe Solution** – for any size of project.

Future-proof solutions

Our objective is to actively influence technical innovation and modern application solutions. BERNSTEIN has therefore always been at the centre of defining trends in technology. With an unwavering commitment to the future we will continue providing the best possible answers in terms of technology, ecology and economic efficiency.

That is our definition of progress!

BERNSTEIN AG

The Product Lines

Switch Systems



Switch systems – Economy meets safety

BERNSTEIN electromechanical switches offer a convincing price/performance ratio and impress with their extreme reliability for many different operating voltages. The range extends from limit switches, encapsulated in insulating material or metal, through foot switches to safety switching devices. The AS-i compatible products save time and material in installation and provide cost advantages in operation. The comprehensive range of designs and sizes, the possible switching functions and the choice of actuators make virtually any application reality.

Sensor Systems



Sensor systems – Compact intelligence

The extremely fast and exceptionally precise BERNSTEIN sensors operate without interference and wear in all applications. The tried-and-tested reliability and the compact dimensions are greatly appreciated in all branches of industry. Matching the specific application, in addition to ultrasonic sensors and level switches, customers can choose from a wide range of inductive, capacitive, magnetic or optical sensors. Alongside the comprehensive standard range of sensors, we also offer comprehensive development and design for individual solutions.

Enclosure Systems



Enclosure systems – Function and design

With its long tradition in manufacturing enclosures, BERNSTEIN combines superior enclosure technology, designed for encapsulating a diverse range of applications, with ultramodern and variable suspension systems. An extensive range of aluminium and plastic terminal boxes as well as the wiring and circuitry in standard and control enclosures conforming to specific customer requirements round off the product portfolio. Our enclosures conform to standards used in medical technology, industry as well as food and EX applications.

Product Line

Sensor Systems



Sensor systems – Compact intelligence

BERNSTEIN is an established manufacturer of high quality electromechanical and electronic low voltage switching devices and sensors. Our products are used in the most diverse range of applications, ranging from lift construction through wood-working and packaging machines through to machine tools.

Contactless sensors are characterised by absolute reliability, suitability for a wide range of applications and optimum cost-benefit ratio. Their main purpose is to convert mechanical movement into electrical signals that are processed in control systems.

In modern day applications, however, sensors directly connected to bus systems are being used to an ever greater extent to monitor mechanical movement and convert it into digital information.

Selecting the right sensor for the job depends on the prevailing ambient and operating conditions as well as corresponding technical requirements. In addition to the detection method (inductive, capacitive, optical, ultrasonic or magnetic) it is also necessary to select the corresponding output function (PNP, NPN, AC, normally-closed or normally-open contact). Sensing distances as well as the direction and type of approach are also important selection criteria. In view of the large number of possible combinations, the scope of application is virtually unlimited.

Maximum functions – minimum space

The range of applications in which limit switches are used has changed in line with increasing automation. Sensors are no longer used purely for the purpose of detecting position but rather they must be able to output analogue values for the purpose of calculating the distance with the necessary signal processing already taking place in the sensor itself. A sensor can also be used to sample two switching points in order to reduce the number of components in machines and systems.



This functionality is achieved by the use of state-of-the-art microcontrollers and advanced sensor technologies. Modern sensors from BERNSTEIN therefore open up new applications, extend the range of functions and as a result significantly increase efficiency.

Complementing our product range we offer attractive customer services:

- Assistance in assessing risk and configuring safety functions
- Preassembly of products with standard power supply lines or customised cables
- Supply of M8 or M12 connection technology
- Development of sensors to customer specifications
- Development and manufacture of customer-specific system solutions







Inductive Sensors

Type	Page
General	12
 <ul style="list-style-type: none"> • \varnothing 3 mm • \varnothing 4 mm • \varnothing 6,5 mm • M4 • M5 	14
 <ul style="list-style-type: none"> • M8 	16
 <ul style="list-style-type: none"> • M12 	18
 <ul style="list-style-type: none"> • M18 	22
 <ul style="list-style-type: none"> • M30 	28
 <ul style="list-style-type: none"> • \varnothing 34 mm 	32
 <ul style="list-style-type: none"> • 5 x 5 x 25 mm • 8 x 8 x 40 mm • 8 x 8 x 56 mm • 12 x 12 x 55 mm 	32
 <ul style="list-style-type: none"> • 27 x 10 x 5 mm • 28 x 16 x 11 mm • 40 x 26 x 12 mm • 50 x 25 x 10 mm • 60 x 36 x 10 mm 	33
 <ul style="list-style-type: none"> • 68 x 30 x 15 mm • 40 x 40 mm 	36

Capacitive Sensors

Type	Page
General	38
 <ul style="list-style-type: none"> • M12 • M18 	42
 <ul style="list-style-type: none"> • M30 • M32 	44
 <ul style="list-style-type: none"> • \varnothing 20 mm • \varnothing 34 mm 	46
 <ul style="list-style-type: none"> • 50 x 25 x 10 mm • 68 x 30 x 15 mm 	47

Optoelectronic Sensors

Type	Page
General	48
 <ul style="list-style-type: none"> • M12 	50
 <ul style="list-style-type: none"> • M18 • M30 	51
 <ul style="list-style-type: none"> • 12 x 12 x 55 mm • 12 x 12 x 60 mm • 12 x 12 x 65 mm 	56
 <ul style="list-style-type: none"> • 30 x 30 x 15 mm • 40 x 26 x 12 mm 	57
 <ul style="list-style-type: none"> • 88 x 63 x 24 mm 	60
 <ul style="list-style-type: none"> • \varnothing 20 mm 	62

Magnetic Switches

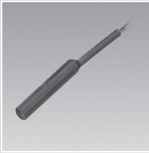
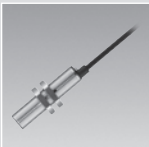
Type	Page
General	64
 Electromechanical magnetic switches	68
• Plastic	
• Metal	
General	76
 Electronic magnetic sensors	78
• Plastic	
• Metal	

Ultrasonic Sensors

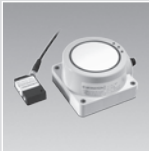
Type	Page
General	98
 • M12	100
• M18	
• M30	
 • 40,5 x 26 x 12 mm	104
• 80 x 80 x 50 mm	





Accessories

 Magnets	136
 Cable couplers	142
 • Reflectors	144
• Mounting brackets	
 Sensor tester	147

Slot Sensors

Type	Page
General	85
 • E22	86
• E30	
• Analogue	
• Teachable	
• Electronic	
• Reed contact	

Float Switches

Type	Page
General	106
 Standard float switches	112
• Stainless	
• Brass	
• PVC	
 Miniature float switches	120
• Stainless	
• Brass	
• PP	
• PVC	
 Adjustable float switches	124
• Stainless	
• PVC	
 Accessories	128
• Range of floats	
• Technical data	
• Chemical resistance table	
• Enquiry/order form	

Contactless safety technology

Type	Page
General	90
 CSMS RFID Safety sensor	91
 Magnetic Monitoring Systems	95
 Magnetic Safety Sensors	95

Annex

Type code	148
Wiring diagrams	178

Inductive Sensors

Functional principle

In general, inductive proximity switches consist of four basic elements: a coil, an oscillator, a threshold switch and an output stage with short-circuit protection. The oscillator generates a high frequency, electromagnetic alternating field which is emitted from the active face of the coil. Eddy currents are induced in a metal object that enters this field. These eddy currents draw energy from both the electromagnetic field and from the oscillator which is consequently attenuated. The more energy taken the closer the metal object moves towards the active face. The threshold switch switches on the output stage at a defined attenuation value. In proximity switches with a DC voltage supply, this switch is designed as an NPN transistor which switches the connected load to the negative pole or as a PNP transistor which switches the load to the positive pole. The output stage is a thyristor or a triac in AC voltage switches.

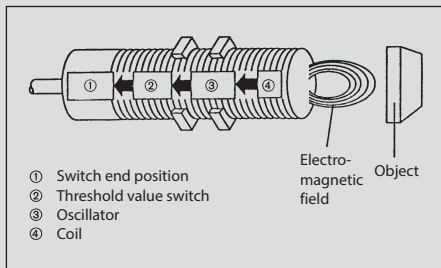

Sensing distance

The sensing distance (gap) is determined by the coil diameter, i.e. larger sensors are required for larger sensing distances. The sensing distance is also dependent on the size of the metal object to be detected as well as the material it is made from.

Target

The sensing distance is measured with a 1 mm thick square measuring plate made of steel (ST 37) referred to as a target. The edge length is equal to the diameter of the active face or equal to three times the sensing distance depending on which value is greater.

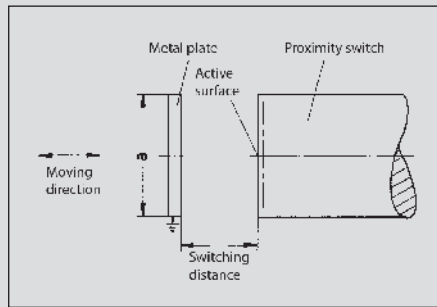

Nominal sensing distance: (S_n)

The nominal sensing distance is a device-specific characteristic value that is dependent on the coil diameter.

Real sensing distance: (S_r)

The real sensing distance is measured at nominal voltage and nominal temperature. It must be between 90 % – 110 % of the nominal sensing distance.

Useable sensing distance: (S_u)

The useable sensing distance is measured within the permissible temperature and voltage ranges and is 90 % – 110 % of the real sensing distance.

Operational sensing distance: (S_a) (Assured operation distance)

The operational sensing distance takes into account the influence of the supply voltage, temperature and control systems. Reliable switching under all permissible operating conditions is assured within 0 % – 81 % of the nominal sensing distance. $S_a \sim 0.81 S_n$.

Hysteresis: (H)

Hysteresis refers to the difference between the switch-on point as an object approaches and the switch-off point as the object moves away. This hysteresis is specified as a percentage of the nominal sensing distance and is typically 10 %. It is required to prevent the output chattering in response to slowly approaching objects, temperature drift, electrical interference or vibration.

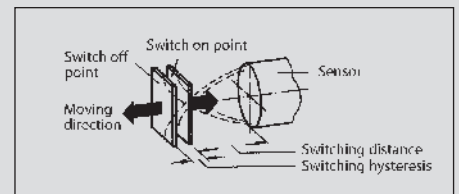
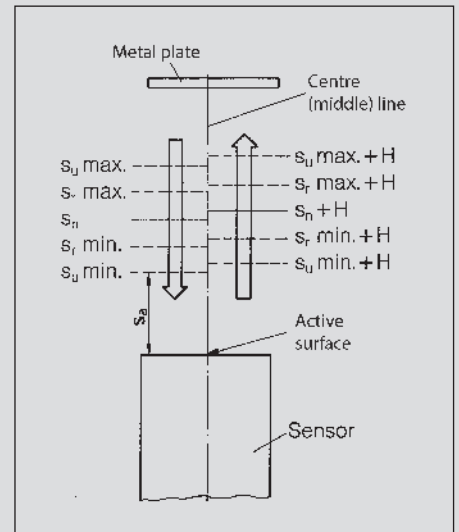

Repeatability

Repeatability is the ability of a sensor to repeatedly detect an object at the same distance away from the sensing surface. The typical deviation is < 5 %.

Reduction factors

The definition of the sensing distance is based on the measurement performed with a standardised square target made of steel. If other materials with the same dimensions are used, the sensing distance will be reduced as shown in the following graphic.

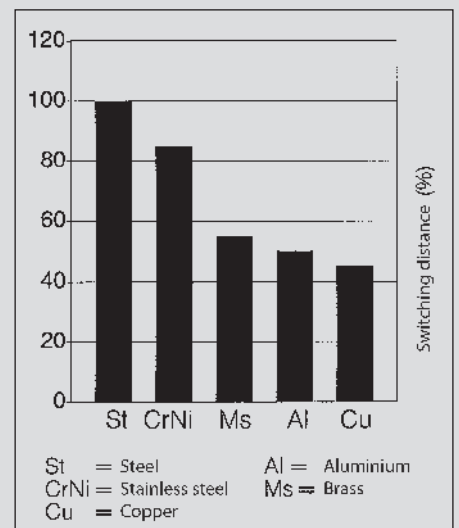

Switching frequency

The switching frequency is measured with a redating, non-conductive plate, on which the standard targets are mounted as illustrated (size of targets as previously defined).

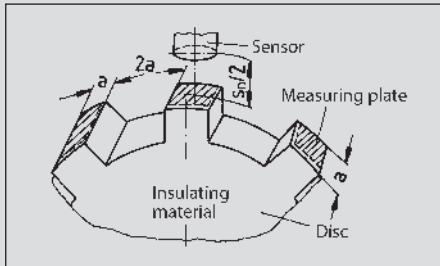

The distance between the targets and sensor is equal to half the nominal sensing distance. The maximum switching frequency is reached when the switch-on or switch-off signal time drops below 50 µs.

Temperature range

For most sensors, the permissible ambient temperature range is between -25 °C and +70 °C (-13 °F to +158 °F). Sensors with an extended temperature range of -40 °C to +100 °C are also available.

Assembly

Inductive sensors contain a coil on a ferromagnetic core that bundles the electromagnetic alternating field. The core is installed into the enclosure in such a way that the field emerges from the switch at the active face. A part of the magnetic field, however, also emerges from the side of the core. The sensor in a flush mount arrangement would already be influenced by the metal on the sides. For this reason, a metal band is fitted about the core in plastic enclosures, thus restricting the lateral magnetic field in a flush mount configuration. Due to the pre-attenuation attributed to the metal ring or a metal enclosure, flush mount versions have a shorter sensing distance than non-flush mount sensors and can be mounted closer to each other.

Flush mount

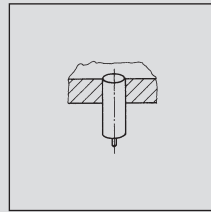

The active face can be flush with a metal surface.

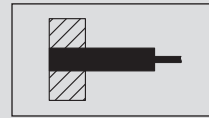

Catalogue symbol for flush mount

Non-flush mount

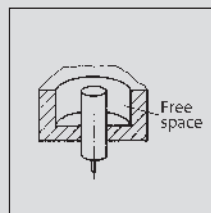

Sensors for non-flush mount require a clearance equal to three times the sensor enclosure diameter and a min. depth of 2x Sn.

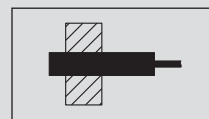

Catalogue symbol for non-flush mount

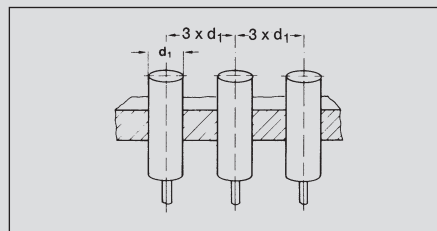

Minimum spacing between non-flush mount sensors

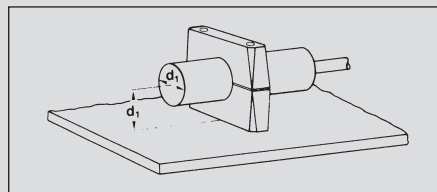

Installation with a mounting bracket parallel to a steel wall

NAMUR sensors

(Standardization association for measurement and control in chemical industries)

Protection class

Corresponding to their ID code, the enclosures are dustproof and waterproof in accordance with IP 65 or IP 67 (EN 60529).

Short-circuit protection

Standard sensors are protected against short-circuit (cyclic) and polarity reversal.

Tightening torque requirements

BERNSTEIN supplies corresponding mounting nuts with its sensors. Refer to the respective datasheets for the required tightening torque.

Tightening torque examples for sensors in brass enclosure:

M4	0.8 Nm
M5	1.5 Nm
M8	8 Nm
M12	10 Nm
M18	25 Nm
M30	70 Nm

Materials

The sensors are protected by a glass fibre reinforced thermoplastic, brass or stainless steel enclosure. The connection cable has a PVC or PU sheathing.

Connection systems

The following connection systems are available for standard sensors:

- Cable variants (2 m) with PVC or PUR sheathing
- Connector variants with M8, M12 connector or connector conforming to DIN 43650
- Quick-connect system with Ultralock connectors

Standards and approvals

All sensors are CE-certified. The following European standards apply in accordance with CENELEC:

- EN 60947-5-2 Proximity switches
- EN 60947-5-6 NAMUR sensors

Inductive Sensors (Type Ø 3 mm, Ø 4 mm, Ø 6.5 mm, M4, M5)

Type	Ø 3 mm	Ø 4 mm	Ø 6.5 mm	
Type of installation	Flush	Flush	Flush	Flush
Nominal sensing distance	0.6 mm	0.8 mm	1.5 mm	1.5 mm
Type of connection	Cable 2 m	Cable 2 m	Cable 2 m	Connector M8
Special feature				

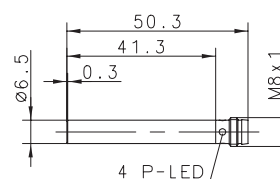
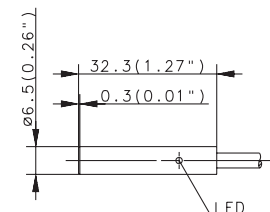
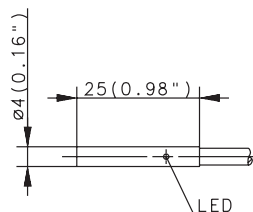
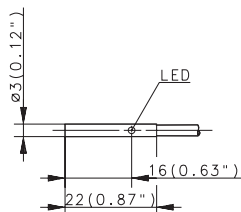

PNP	DC	NO contact	6502999019 KIB-D03PS/0,6-KL2PU	6502999004 KIB-D04NS/0,8-KL2PU	6502999010 KIB-D06PS/1,5-KL2	6502999012 KIB-D06PS/1,5-KLSM8
		Type NC contact Type Antivalent NO/NC				
NPN	DC	NO contact		6502399004 KIB-D04NS/0,8-KL2PU		
		Type NC contact Antivalent NO/NC				
PNP/NPN	DC	NO/NC prog. push-pull operation				
NAMUR	DC	Type				
Analogue	DC					
2-wire	DC	NO contact NC contact				
	AC	NO contact NC contact Changeover contact				

Technical data

Rated operating voltage	U_B	10–30 VDC	10–30 VDC	10–36 VDC	10–36 VDC
Rated operating current	I_B	≤ 100 mA	≤ 200 mA	≤ 200 mA	≤ 200 mA
Switching frequency (max)	F	3000 Hz	3000 Hz	1000 Hz	1000 Hz
Short circuit-protection		Cyclic	Cyclic	Cyclic	Cyclic
Function/operating voltage indicator		LED/-	LED/-	LED/-	LED/-
Sensing distance, adjustable					

Mechanical data

Ambient temperature (min/max)		-25°C/+70°C	-25°C/+70°C	-25°C/+70°C	-25°C/+70°C
Protection class in accordance with IEC 529, EN 60529		IP67	IP67	IP67	IP67
Enclosure material		Stainless steel 1.4305	Stainless steel 1.4401	Stainless steel 1.4401	Stainless steel 1.4401
Connection		3 x 0.055 mm ²	3 x 0.14 mm ²	3 x 0.14 mm ²	M8 x 1

Please refer to Accessories for cable couplers, mounting brackets and sensor tester.



Ø 6.5 mm		M4	M5	M5	
Flush	Flush	Flush	Flush	Flush	Flush
1.5 mm	1.5 mm	0.6 mm	1 mm	1 mm	1 mm
Cable 2 m	Cable 5 m	Cable 2 m	Cable 2 m	Connector M8	Cable 2 m
					NAMUR

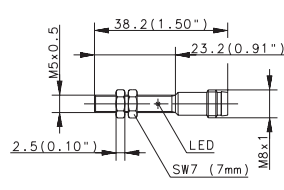
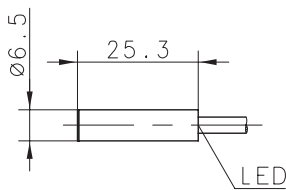
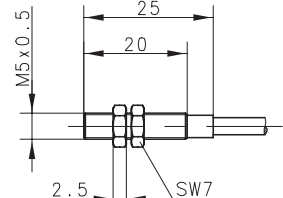
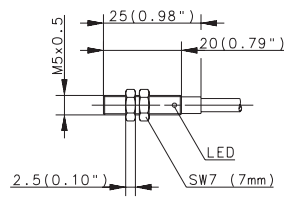
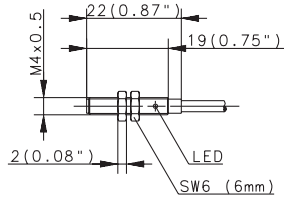
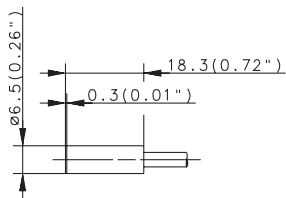

6502999034 KIB-D06PS/1,5-K2VPU	6602999460 KIB-D06PS/1,5-KL5V	6502999020 KIB-M04PS/0,6-KL2PU		6502999003 KIB-M05NS/001-KL2PU 6502799001 KIB-M05PÖ/001-KL2PU	6502999018 KIB-M05PS/001-KLSM8 6502799019 KIB-M05PÖ/001-KLSM8		
				6502399003 KIB-M05NS/001-KL2PU			
							6501699008 KIB-M05EA/001-2

10–36 VDC	10–36 VDC	10–30 VDC	10–30 VDC	10–30 VDC	5–25 VDC
≤ 200 mA	≤ 200 mA	≤ 100 mA	≤ 200 mA	≤ 200 mA	–
1000 Hz	1000 Hz	3000 Hz	3000 Hz	3000 Hz	≈ 3 kHz
Cyclic	Cyclic	Cyclic	Cyclic	Cyclic	–
–/–	LED/–	LED/–	LED/–	LED/–	–/–

–25°C/+70°C	–25°C/+70°C	–25°C/+70°C	–25°C/+70°C	–25°C/+70°C	–25°C/+70°C
IP67	IP67	IP67	IP67	IP67	IP67
Stainless steel 1.4401	Stainless steel 1.4401	Stainless steel 1.4305	CuZn39Pb3	CuZn39Pb3	CuZn39Pb3
3 x 0.14 mm ²	3 x 0.14 mm ²	3 x 0.055 mm ²	3 x 0.14 mm ²	M8 x 1	2 x 0.14 mm ²

You will find detailed data sheets to the products under www.bernstein.eu



Inductive Sensors (Type M8)

Type	M8		M8		M8
Type of installation	Flush	Flush	Flush	Flush	Flush
Nominal sensing distance	1.5 mm	1.5 mm	1.5 mm	1.5 mm	1.5 mm
Type of connection	Cable 2 m	Cable 6 m	Connector M8	Connector M8	Connector M12
Special feature					

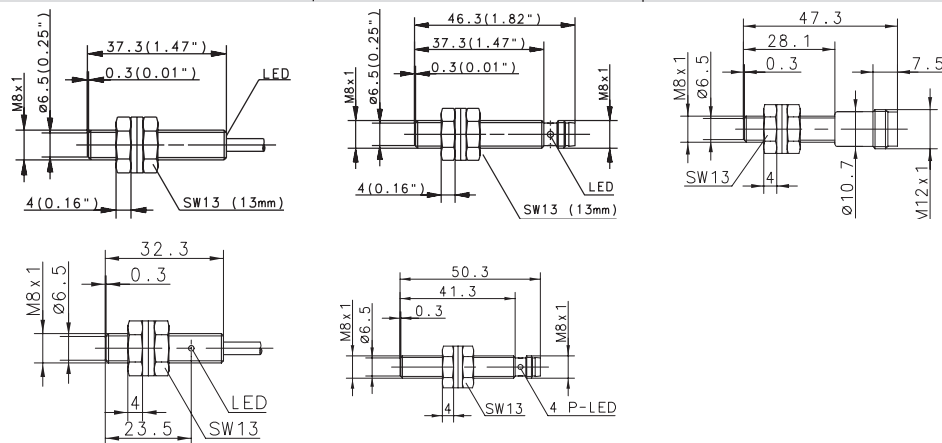

PNP	DC	NO contact Type NC contact Type Antivalent NO/NC	6932901001 KIB-M08PS/1,5-KL2	6502901004 KIB-M08PS/1,5-KL6 6502701001 KIB-M08PÖ/1,5-KL2	6932942001 KIB-M08PS/1,5-KLSM8	6502742001 KIB-M08PÖ/1,5-KLSM8	6502942007 KIB-M08PS/0,1-KS12
NPN	DC	NO contact Type NC contact Antivalent NO/NC	6932301001 KIB-M08NS/1,5-KL2		6932342001 KIB-M08PS/1,5-KLSM8		
PNP/NPN	DC	NO/NC prog. push-pull operation					
NAMUR	DC	Type					
Analogue	DC						
2-wire	DC	NO contact NC contact					
	AC	NO contact NC contact Changeover contact					

Technical data

Rated operating voltage	U_B	10–36 VDC	10–36 VDC	10–36 VDC	10–36 VDC	10–36 VDC
Rated operating current	I_B	≤ 200 mA	≤ 200 mA	≤ 200 mA	≤ 200 mA	≤ 200 mA
Switching frequency (max)	F	1000 Hz	1000 Hz	1000 Hz	1000 Hz	1000 Hz
Short circuit-protection		Cyclic	Cyclic	Cyclic	Cyclic	Cyclic
Function/operating voltage indicator		LED/-	LED/-	LED/-	LED/-	-/-
Sensing distance, adjustable						

Mechanical data

Ambient temperature (min/max)		-25°C/+70°C	-25°C/+70°C	-25°C/+70°C	-25°C/+70°C	-25°C/+70°C
Protection class in accordance with IEC 529, EN 60529		IP67	IP67	IP67	IP67	IP67
Enclosure material		Stainless steel 1.4305	Stainless steel 1.4305	Stainless steel 1.4305	Stainless steel 1.4305	Stainless steel 1.4305
Connection		3 x 0.14 mm ²	3 x 0.14 mm ²	M8 x 1	M8 x 1	M12 x 1

Please refer to Accessories for cable couplers, mounting brackets and sensor tester.



M8	M8	M8	
Flush	Non-flush	Non-flush	Non-flush
1.5 mm	2 mm	2 mm	2 mm
Cable 2 m	Cable 2 m	Connector M8	Connector M12
NAMUR			

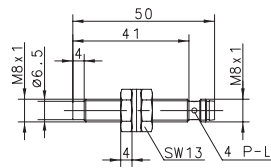
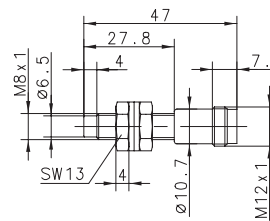
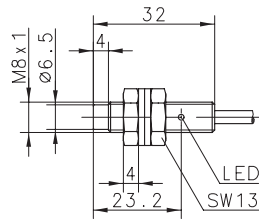
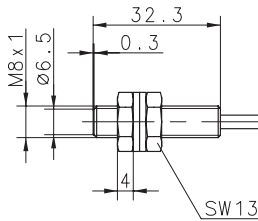

		6502916003 KIN-M08PS/002-KL2	6502942006 KIN-M08PS/002-KLSM8	6502942008 KIN-M08PS/002-KS12		
6501601003 KIB-M08EA/1,5-2						

5-25 VDC	10-36 VDC	10-36 VDC	10-36 VDC
-	≤ 200 mA	≤ 200 mA	≤ 200 mA
≈ 1 kHz	750 Hz	750 Hz	750 Hz
-	Cyclic	Cyclic	Cyclic
-/-	LED/-	LED/-	-/-

-25°C/+70°C	-25°C/+70°C	-25°C/+70°C	-25°C/+70°C
IP67	IP67	IP67	IP67
Stainless steel 1.4305	Stainless steel 1.4305	Stainless steel 1.4305	Stainless steel 1.4305
2 x 0.25 mm ²	3 x 0.14 mm ²	M8 x 1	M12 x 1

You will find detailed data sheets to the products under www.bernstein.eu



Inductive Sensors (Type M8, M12)

Type	M8	M12	M12	M12
Type of installation	Non-flush	Flush	Flush	Flush
Nominal sensing distance	2 mm	2 mm	2 mm	2 mm
Type of connection	Cable 2 m	Cable 2 m	Cable 2 m	Connector M12
Special feature	NAMUR			

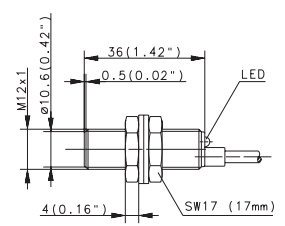
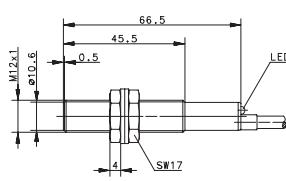
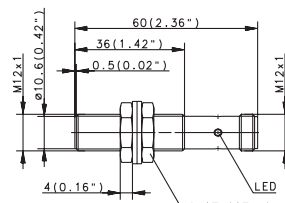
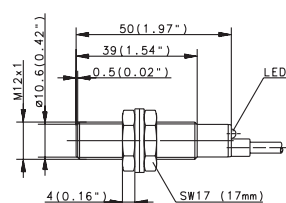
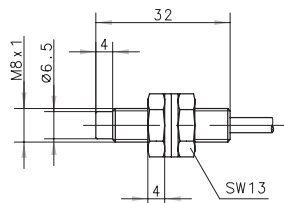

PNP	DC	NO contact Type NC contact Type Antivalent NO/NC		6932903001 KIB-M12PS/002-KL2	6932943001 KIB-M12PS/002-KLS12 6602743112 KIB-M12PÖ/002-KLS12	6502903016 KIB-M12PS/002-KL2V 6502703005 KIB-M12PÖ/002-KL2V
NPN	DC	NO contact Type NC contact Type Antivalent NO/NC		6932303001 KIB-M12NS/002-KL2	6932343001 KIB-M12NS/002-KLS12	6502103003 KIB-M12NÖ/002-KL2V
PNP/NPN	DC	NO/NC prog. push-pull operation				
NAMUR	DC	Type		6501601005 KIN-M08EA/002-2		
Analogue	DC					
2-wire	DC	NO contact NC contact				
	AC	NO contact Type NC contact Changeover contact		6503503001 KIB-M12AS/002-L2		

Technical data

Rated operating voltage	U_B	5–25 VDC	10–36 VDC	76–250 V AC	10–36 VDC	10–36 VDC
Rated operating current	I_B	–	≤ 200 mA	≤ 200 mA	≤ 200 mA	≤ 200 mA
Switching frequency (max)	F	≈ 1 kHz	800 Hz	≈ 10 Hz	800 Hz	800 Hz
Short circuit-protection		–	Cyclic	–	Cyclic	Cyclic
Function/operating voltage indicator		–/–	LED/–	LED/–	LED/–	LED/–
Sensing distance, adjustable						

Mechanical data

Ambient temperature (min/max)	–25°C/+70°C	–25°C/+70°C	–25°C/+70°C	–25°C/+70°C	–25°C/+70°C
Protection class in accordance with IEC 529, EN 60529	IP67	IP67	IP67	IP67	IP67
Enclosure material	Stainless steel 1.4305	CuZn39Pb3	CuZn39Pb3	CuZn39Pb3	CuZn39Pb3
Connection	2 x 0.25 mm ²	3 x 0.14 mm ²	2 x 0.14 mm ²	M12 x 1	3 x 0.14 mm ²

Please refer to Accessories for cable couplers, mounting brackets and sensor tester.



M12	M12	M12	
Flush	Flush	Flush	Flush
2 mm	2 mm	2 mm	2 mm
Connector M8	Connector M12	Cable 2 m	Cable 2 m
		4000 Hz	NAMUR

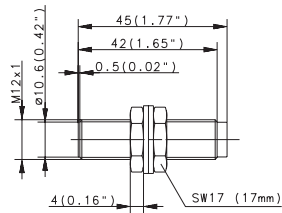
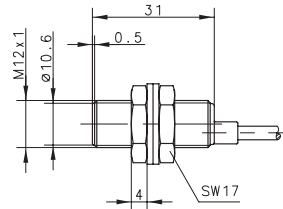
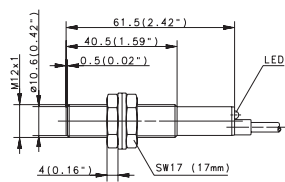
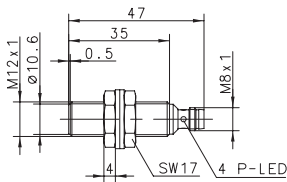

6502943008 KIB-M12PS/002-KLSM8V	6502943006 KIB-M12PS/002-KS12V 6502743005 KIB-M12PÖ/002-KS12V	6502903012 KIB-M12PS/002-KL2F				
				6501624760 KIB-M12EA/002-2		

10–30 VDC	10–36 VDC	10–60 VDC	5–25 VDC
≤ 200 mA	≤ 200 mA	≤ 200 mA	–
800 Hz	800 Hz	4000 Hz	≤ 800 Hz
Cyclic	Cyclic	Cyclic	–
LED/–	–/–	LED/–	–/–

–25°C/+70°C	–25°C/+70°C	–25°C/+70°C	–25°C/+70°C
IP67	IP67	IP67	IP67
CuZn39Pb3	CuZn39Pb3	CuZn39Pb3	CuZn39Pb3
M8 x 1	M12 x 1	3 x 0.14 mm ²	2 x 0.25 mm ²

You will find detailed data sheets to the products under www.bernstein.eu



Inductive Sensors (Type M12)

Type	M12		M12		M12	
Type of installation	Flush	Flush	Flush	Non-flush	Non-flush	
Nominal sensing distance	4 mm	4 mm	4 mm	4 mm	4 mm	
Type of connection	Cable 2 m	Connector M12	Cable 2 m	Cable 2 m	Cable 2 m	
Special feature	Sensing dist.	Sensing dist.	Sensing dist.			

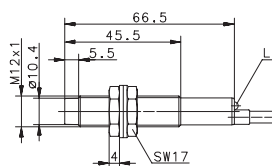
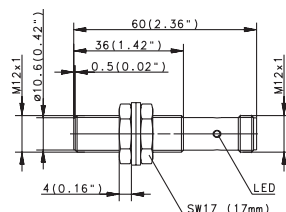
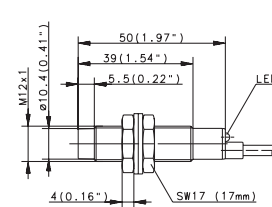
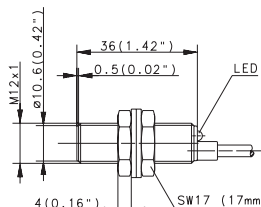
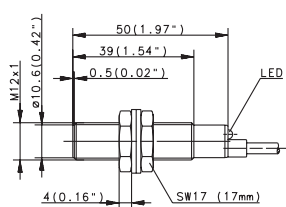

PNP	DC	NO contact	6502903025	6502943015	6502903023	6932904001	6932704001
		Type					
NPN	DC	NC contact					6932304001
		Type					
PNP/NPN	DC	Antivalent NO/NC					6932104001
		Type					
NAMUR	DC	Antivalent NO/NC					
		Type					
Analogue	DC	NO/NC prog. push-pull operation					
2-wire	DC	NO contact					6503504001
		NC contact					
2-wire	AC	NO contact					6503404001
		NC contact					
2-wire	AC	Changeover contact					
		Type					

Technical data

Rated operating voltage	U_B	10–30 VDC	10–36 VDC	10–36 VDC	10–36 VDC	76–250 V AC
Rated operating current	I_B	≤ 200 mA	≤ 200 mA	≤ 200 mA	≤ 200 mA	≤ 200 mA
Switching frequency (max)	F	800 Hz	800 Hz	800 Hz	400 Hz	≈ 10 Hz
Short circuit-protection		Cyclic	Cyclic	Cyclic	Cyclic	–
Function/operating voltage indicator		LED/–	LED/–	LED/–	LED/–	LED/–
Sensing distance, adjustable						

Mechanical data

Ambient temperature (min/max)		–25°C/+70°C	–25°C/+70°C	–25°C/+70°C	–25°C/+70°C	–25°C/+70°C
Protection class in accordance with IEC 529, EN 60529		IP67	IP67	IP67	IP67	IP67
Enclosure material		CuZn39Pb3	CuZn39Pb3	CuZn39Pb3	CuZn39Pb3	CuZn39Pb3
Connection		3 x 0.14 mm ²	M12 x 1	3 x 0.14 mm ²	3 x 0.14 mm ²	2 x 0.14 mm ²

Please refer to Accessories for cable couplers, mounting brackets and sensor tester.



M12		M12			
Non-flush 4 mm Connector M12	Non-flush 4 mm Cable 2 m	Non-flush 4 mm Connector M12	Non-flush 4 mm Cable 2 m Plastic		

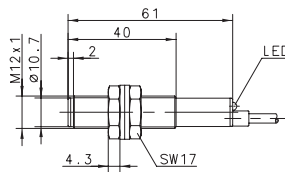
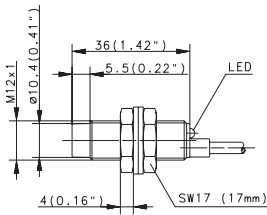
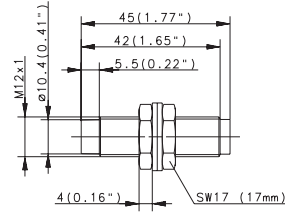
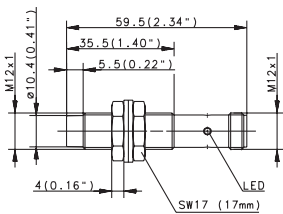

6932944001 KIN-M12PS/004-KLS12	6502904014 KIN-M12PS/004-KL2V	6502944006 KIN-M12PS/004-KS12V	6502919001 KIN-T12PS/004-KL2				
6502744003 KIN-M12PÖ/004-KLS12							
6932344001 KIN-M12NS/004-KLS12							

10–36 VDC	10–36 VDC	10–36 VDC	10–30 VDC		
≤ 200 mA	≤ 200 mA	≤ 200 mA	≤ 200 mA		
400 Hz	400 Hz	400 Hz	400 Hz		
Cyclic	Cyclic	Cyclic	Cyclic		
LED/–	LED/–	–/–	LED/–		

–25°C/+70°C	–25°C/+70°C	–25°C/+70°C	–25°C/+70°C		
IP67	IP67	IP67	IP67		
CuZn39Pb3	CuZn39Pb3	CuZn39Pb3	PA, red		
M12 x 1	3 x 0.14 mm ²	M12 x 1	3 x 0.14 mm ²		

You will find detailed data sheets to the products under www.bernstein.eu



Inductive Sensors (Type M12, M18)

Type	M12	M12	M12	M18	M18
Type of installation	Non-flush	Non-flush	Non-flush	Flush	Flush
Nominal sensing distance	4 mm	8 mm	8 mm	5 mm	5 mm
Type of connection	Cable 2 m	Cable 2 m	Connector M12	Cable 2 m	Cable 2 m
Special feature	NAMUR	Sensing dist.	Sensing dist.		

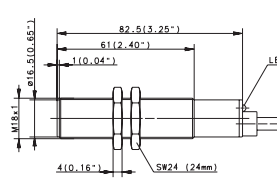
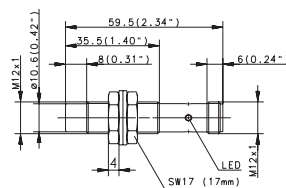
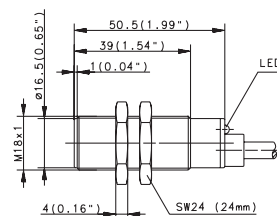
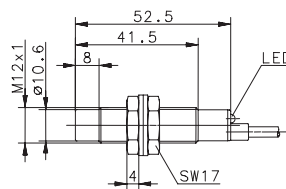
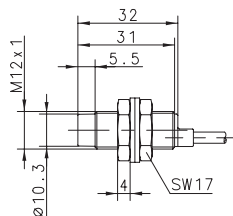

PNP	DC	NO contact Type NC contact Type Antivalent NO/NC Type		6502904021 KIN-M12PS/008-KL2E	6502944013 KIN-M12PS/008-KLS12E	6932905001 KIB-M18PS/005-KL2 6932705001 KIB-M18PÖ/005-KL2
NPN	DC	NO contact Type NC contact Type Antivalent NO/NC Type			6602344458 KIN-M12NS/008-KLS12E	6932105001 KIB-M18NÖ/005-KL2
PNP/NPN	DC	NO/NC prog. push-pull operation				
NAMUR	DC	Type	6501625761 KIN-M12EA/004-2			
Analogue	DC					
2-wire	DC	NO contact NC contact				6503505004 KIB-M18AS/005-L2 6503405001 KIB-M18AÖ/005-L2
	AC	NO contact Type NC contact Type Changeover contact				

Technical data

Rated operating voltage	U_B	5–25 VDC	10–36 VDC	10–36 VDC	10–36 VDC	20–250 V AC
Rated operating current	I_B	–	≤ 200 mA	≤ 200 mA	≤ 200 mA	≤ 400 mA
Switching frequency (max)	F	≤ 400 Hz	400 Hz	400 Hz	500 Hz	≈ 10 Hz
Short circuit-protection		–	Cyclic	Cyclic	Cyclic	–
Function/operating voltage indicator		–/–	LED/–	LED/–	LED/–	LED/–
Sensing distance, adjustable						

Mechanical data

Ambient temperature (min/max)		–25°C/+70°C	–25°C/+70°C	–25°C/+70°C	–25°C/+70°C	–25°C/+70°C
Protection class in accordance with IEC 529, EN 60529		IP67	IP67	IP67	IP67	IP67
Enclosure material		CuZn39Pb3	CuZn39Pb3	CuZn39Pb3	CuZn39Pb3	CuZn39Pb3
Connection		2 x 0.25 mm ²	3 x 0.14 mm ²	M12 x 1	3 x 0.5 mm ²	2 x 0.5 mm ²

Please refer to Accessories for cable couplers, mounting brackets and sensor tester.



M18		M18		M18		M18	
Flush	Flush	Flush	Flush	Flush	Flush	Flush	Flush
5 mm	5 mm	5 mm	5 mm	5 mm	5 mm	5 mm	5 mm
Connector M12	Cable 6 m	Connector M12	DIN Connector	DIN Connector	DIN Connector	Cable 2 m	Cable 2 m
						Plastic	Plastic

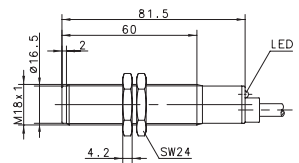
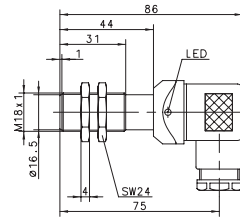
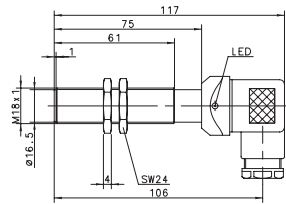
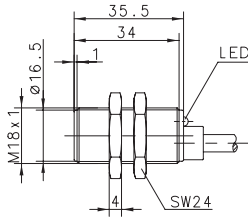
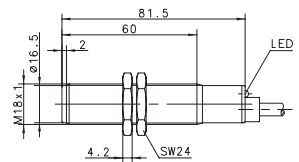
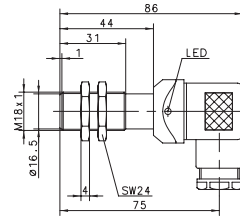
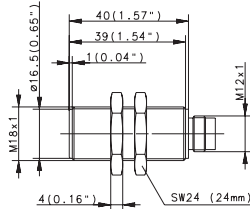
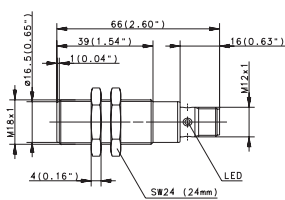

6932905004 KIB-M18PS/005-KLS12	6502905013 KIB-M18PS/005-KL6V	6502905012 KIB-M18PS/005-KS12V 6502705007 KIB-M18PÖ/005-KS12V	6602905662 KIB-M18PS/005-KLSD 6502705001 KIB-M18PÖ/005-KLSD	6502940001 KIB-M18PS/005-KLSDV 6502840002 KIB-M18PU/005-KSDV	6502920990 KIB-T18PS/005-KL2		
6932305004 KIB-M18NS/005-KLS12							6503520697 KIB-T18AS/005-L2

10–36 VDC	10–60 VDC	10–60 VDC	10–60 VDC	10–60 VDC	10–60 VDC	10–60 VDC	24–250 V AC
≤ 200 mA	≤ 200 mA	≤ 200 mA	≤ 200 mA	≤ 200 mA	≤ 200 mA	≤ 200 mA	≤ 200 mA
500 Hz	500 Hz	500 Hz	500 Hz	500 Hz	500 Hz	500 Hz	≈ 10 Hz
Cyclic	Cyclic	Cyclic	–	Cyclic	Cyclic	Cyclic	–
LED/–	LED/–	–/–	LED/–	LED/–	–/–	LED/–	LED/–

–25°C/+70°C	–25°C/+70°C	–25°C/+70°C	–25°C/+70°C	–25°C/+70°C	–25°C/+70°C	–25°C/+70°C	–25°C/+70°C
IP67	IP67	IP67	IP65	IP65	IP65	IP67	IP67
CuZn39Pb3	CuZn39Pb3	CuZn39Pb3	CuZn39Pb3	CuZn39Pb3	CuZn39Pb3	PA, red	PA, red
M12 x 1	3 x 0.5 mm ²	M12 x 1	DIN 43650	DIN 43650	DIN 43650	3 x 0.5 mm ²	2 x 0.5 mm ²

You will find detailed data sheets to the products under www.bernstein.eu



Inductive Sensors (Type M18)

Type	M18		M18		M18	
Type of installation	Flush	Flush	Flush	Flush	Flush	Flush
Nominal sensing distance	5 mm	5 mm	5 mm	8 mm	8 mm	8 mm
Type of connection	Connector M12	Cable 2 m	Cable 2 m	Cable 2 m	Connector M12	Connector M12
Special feature	Temperature	Temperature	NAMUR	Sensing dist.	Sensing dist.	Sensing dist.

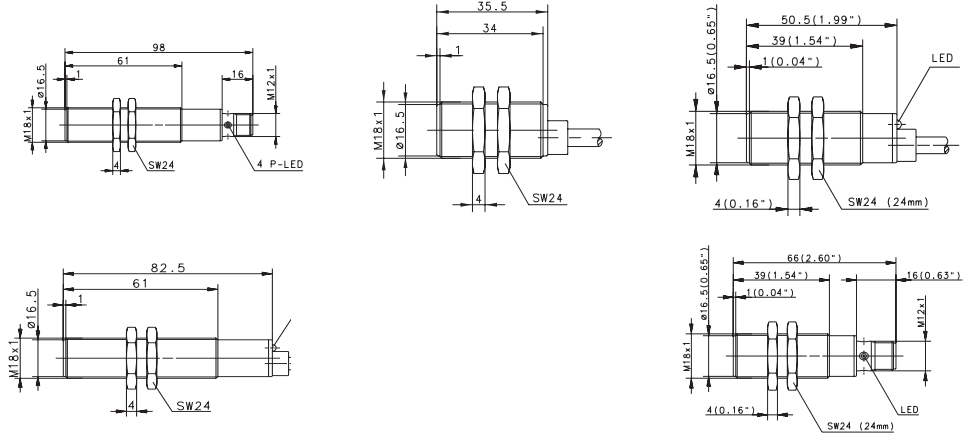

PNP	DC	NO contact Type NC contact Type Antivalent NO/NC Type	6502940006 KIB-M18PS/005-KLS12T	6502905023 KIB-M18PS/005-KL2PUT		6502905022 KIB-M18PS/008-KL2E	6502940005 KIB-M18PS/008-KLS12E
	NPN	DC	NO contact Type NC contact Antivalent NO/NC Type				
PNP/NPN	DC	NO/NC prog. push-pull operation					
NAMUR	DC	Type			6501626762 KIB-M18EA/005-2		
Analogue	DC						
	2-wire	DC	NO contact NC contact				
	AC	NO contact Type NC contact Type Changeover contact					

Technical data

Rated operating voltage	U_B	10–30 VDC	10–30 VDC	5–25 VDC	10–36 VDC	10–36 VDC
Rated operating current	I_B	≤ 200 mA	≤ 200 mA	–	≤ 200 mA	≤ 200 mA
Switching frequency (max)	F	500 Hz	500 Hz	≤ 400 Hz	500 Hz	500 Hz
Short circuit-protection		Cyclic	Cyclic	–	Cyclic	Cyclic
Function/operating voltage indicator		LED/–	LED/–	–/–	LED/–	LED/–
Sensing distance, adjustable						

Mechanical data

Ambient temperature (min/max)	–40°C/+100°	–40°C/+100°	–25°C/+70°C	–25°C/+70°C	–25°C/+70°C
Protection class in accordance with IEC 529, EN 60529	IP67	IP67	IP67	IP67	IP67
Enclosure material	CuZn39Pb3	CuZn39Pb3	CuZn39Pb3	CuZn39Pb3	CuZn39Pb3
Connection	M12 x 1	3 x 0.5 mm ²	2 x 0.5 mm ²	3 x 0.5 mm ²	M12 x 1

Please refer to Accessories for cable couplers, mounting brackets and sensor tester.



M18		M18		M18	
Flush	Flush	Flush	Non-flush	Non-flush	
8 mm	8 mm	8 mm	8 mm	8 mm	
Cable 2 m	DIN Connector	Connector M12	Cable 2 m	Cable 2 m	
Sensing dist.	Sensing dist.	Sensing dist.			

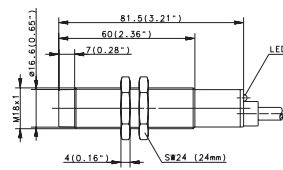
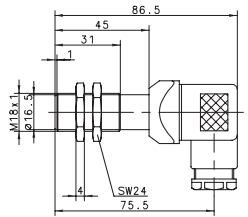
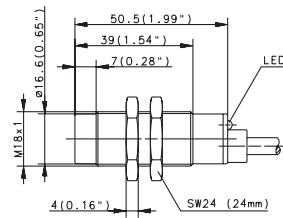
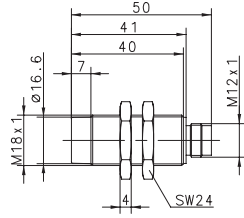
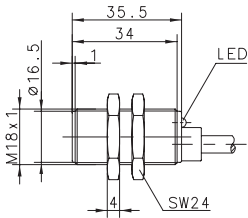

6502905010 KIB-M18PS/008-KL2VE	6602840128 KIB-M18PU/008-KSDVE	6502906009 KIB-M18PS/008-KS12V	6932906001 KIN-M18PS/008-KL2 6932706001 KIN-M18PÖ/008-KL2		
			6932306001 KIN-M18NS/008-KL2		
				6503506002 KIN-M18AS/008-L2 6503406001 KIN-M18AÖ/008-L2	

10–36 VDC	12–48 VDC	10–60 VDC	10–36 VDC	20–250 V AC
≤ 200 mA	≤ 400 mA	≤ 200 mA	≤ 200 mA	≤ 400 mA
500 Hz	500 Hz	200 Hz	200 Hz	≈ 10 Hz
Cyclic	–	Cyclic	Cyclic	–
LED/–	–/–	–/–	LED/–	LED/–

–25°C/+70°C	–25°C/+70°C	–25°C/+70°C	–25°C/+70°C	–25°C/+70°C
IP67	IP65	IP67	IP67	IP67
CuZn39Pb3	CuZn39Pb3	CuZn39Pb3	CuZn39Pb3	CuZn39Pb3
3 x 0.5 mm ²	DIN 43650	M12 x 1	3 x 0.5 mm ²	2 x 0.5 mm ²

You will find detailed data sheets to the products under www.bernstein.eu



Inductive Sensors (Type M18)

Type	M18		M18		M18
Type of installation	Non-flush	Non-flush	Non-flush	Non-flush	Non-flush
Nominal sensing distance	8 mm	8 mm	8 mm	8 mm	8 mm
Type of connection	Cable 2 m	Connector M12	Cable 2 m	Cable 2 m	Cable 2 m
Special feature	Plastic			Plastic	

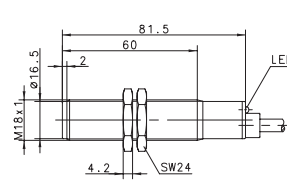
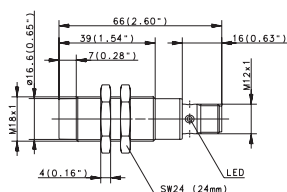
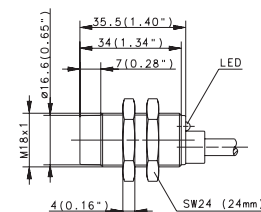
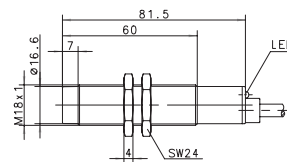
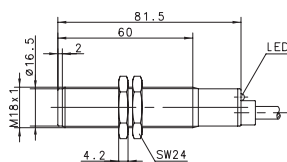

PNP	DC	NO contact Type NC contact Type Antivalent NO/NC Type	6932906004 KIN-M18PS/008-KLS12 6932706002 KIN-M18PÖ/008-KLS12	6502921975 KIN-T18PS/008-KL2	6502906006 KIN-M18PS/008-KL2V 6502706002 KIN-M18PÖ/008-KL2V
NPN	DC	NO contact Type NC contact Antivalent NO/NC	6932306004 KIN-M18NS/008-KLS12		6502306004 KIN-M18NS/008-KL2V
PNP/NPN	DC	NO/NC prog. push-pull operation			
NAMUR	DC				
Analogue	DC	Type			
2-wire	DC	NO contact NC contact Type	6503521705 KIN-T18AS/008-L2 6503421704 KIN-T18AÖ/008-L2	6501306001 KIN-M18ZS/008-L2	
	AC	NO contact Type NC contact Type Changeover contact			

Technical data

Rated operating voltage	U_B	24–250 V AC	10–36 VDC	10–60 VDC	10–60 VDC	10–60 VDC
Rated operating current	I_B	≤ 200 mA	≤ 200 mA	≤ 200 mA	≤ 200 mA	≤ 200 mA
Switching frequency (max)	F	≈ 10 Hz	200 Hz	200 Hz	200 Hz	200 Hz
Short circuit-protection		–	Cyclic	–	Cyclic	Cyclic
Function/operating voltage indicator		LED/–	LED/–	LED/–	LED/–	LED/–
Sensing distance, adjustable						

Mechanical data

Ambient temperature (min/max)		–25°C/+70°C	–25°C/+70°C	–25°C/+70°C	–25°C/+70°C	–25°C/+70°C
Protection class in accordance with IEC 529, EN 60529		IP67	IP67	IP67	IP67	IP67
Enclosure material		PA, red	CuZn39Pb3	CuZn39Pb3	PA, red	CuZn39Pb3
Connection		2 x 0.5 mm ²	M12 x 1	2 x 0.5 mm ²	3 x 0.5 mm ²	3 x 0.5 mm ²

Please refer to Accessories for cable couplers, mounting brackets and sensor tester.



M18		M18		M18	
Non-flush 8 mm DIN Connector	Non-flush 8 mm DIN Connector	Non-flush 8 mm Connector M12 Ultralock	Non-flush 8 mm Cable 2 m	Non-flush 8 mm Connector M12	

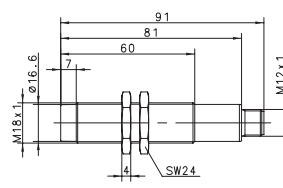
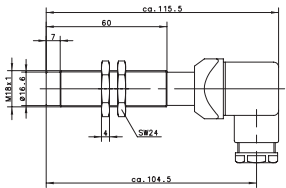
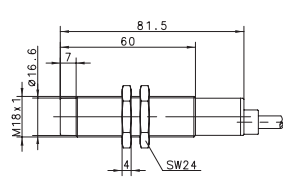
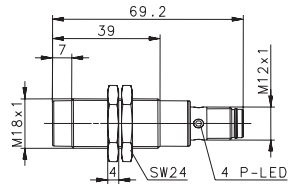
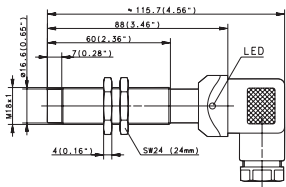

6502941001 KIN-M18PS/008-KLSD					
6502741001 KIN-M18PÖ/008-KLSD	6602841421 KIN-M18PU/008-KSD				
		6502306011 KIN-M18NS/008-KLS12U			
			6502006001 KIN-M18PA/008-2	6602006111 KIN-M18PA/008-S12	

10–60 VDC	10–60 VDC	10–36 VDC	10–36 VDC	10–36 VDC
≤ 200 mA	≤ 200 mA	≤ 200 mA	–	–
200 Hz	200 Hz	200 Hz	–	–
Cyclic	–	Cyclic	Cyclic	–
LED/–	–/–	LED/–	–/–	–/–

–25°C/+70°C	–40°C/+80°C	–25°C/+70°C	–25°C/+70°C	–25°C/+70°C
IP65	IP65	IP67	IP67	IP67
CuZn39Pb3	CuZn39Pb3	CuZn39Pb3	CuZn39Pb3	CuZn39Pb3
DIN 43650	DIN 43650	M12 x 1	3 x 0.5 mm ²	M12 x 1

You will find detailed data sheets to the products under www.bernstein.eu



Inductive Sensors (Type M18, M30)

Type	M18		M30		M30	
Type of installation	Non-flush	Non-flush	Flush	Flush	Flush	Flush
Nominal sensing distance	16 mm	16 mm	10 mm	10 mm	10 mm	10 mm
Type of connection	Cable 2 m	Connector M12	Cable 2 m	Cable 2 m	Connector M12	Cable 2 m
Special feature	Sensing dist.	Sensing dist.				

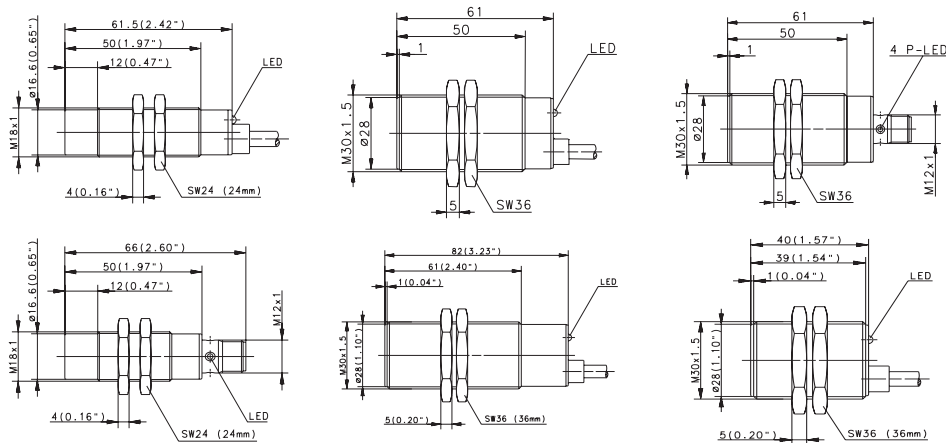

PNP	DC	NO contact Type NC contact Type Antivalent NO/NC	6502906018 KIN-M18PS/016-KL2E	6502941004 KIN-M18PS/016-KLS12E	6932907001 KIN-M18PS/016-KLS12E	6932907002 KIB-M30PS/010-KLS12	6502907003 KIB-M30PS/010-KL2V 6502707001 KIB-M30PÖ/010-KL2V
NPN	DC	NO contact Type NC contact Antivalent NO/NC					
PNP/NPN	DC	NO/NC prog. Type push-pull operation					
NAMUR	DC						
Analogue	DC	Type					
2-wire	DC	NO contact NC contact Type					
	AC	NO contact Type NC contact Type Changeover contact				6503507378 KIB-M30AS/010-L2 6503407240 KIB-M30AÖ/010-L2	

Technical data

Rated operating voltage	U_B	10–36 VDC	10–36 VDC	10–36 VDC	20–250 V AC	10–36 VDC	10–60 VDC
Rated operating current	I_B	≤ 200 mA	≤ 200 mA	≤ 200 mA	≤ 400 mA	≤ 200 mA	≤ 200 mA
Switching frequency (max)	F	200 Hz	200 Hz	300 Hz	≈ 10 Hz	300 Hz	300 Hz
Short circuit-protection		Cyclic	Cyclic	Cyclic	–	Cyclic	Cyclic
Function/operating voltage indicator		LED/–	LED/–	LED/–	LED/–	LED/–	LED/–
Sensing distance, adjustable							

Mechanical data

Ambient temperature (min/max)		–25°C/+70°C	–25°C/+70°C	–25°C/+70°C	–25°C/+70°C	–25°C/+70°C	–25°C/+70°C
Protection class in accordance with IEC 529, EN 60529		IP67	IP67	IP67	IP67	IP67	IP67
Enclosure material		CuZn39Pb3	CuZn39Pb3	CuZn39Pb3	CuZn39Pb3	CuZn39Pb3	CuZn39Pb3
Connection		3 x 0.5 mm ²	M12 x 1	3 x 0.5 mm ²	2 x 0.5 mm ²	M12 x 1	3 x 0.5 mm ²

Please refer to Accessories for cable couplers, mounting brackets and sensor tester.



M30		M30		M30	
Flush	Flush	Flush	Flush	Flush	Flush
10 mm	10 mm	10 mm	10 mm	10 mm	10 mm
Cable 2 m	DIN Connector	DIN Connector	DIN Connector	Cable 2 m	Connector M12
Plastic	Plastic			Temperature	Temperature

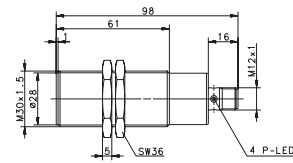
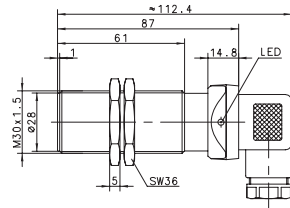
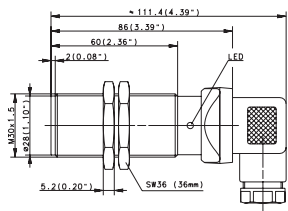
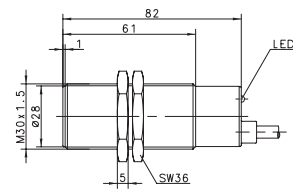
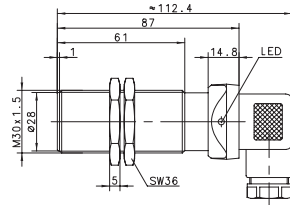
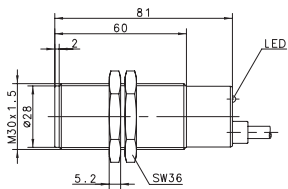

6502722708 KIB-T30PÖ/010-KL2		6502939001 KIB-M30PS/010-KLSD		6502907013 KIB-M30PS/010-KL2PUT	6502939006 KIB-M30PS/010-KLS12T	
	6502822862 KIB-T30PP/010-KLSD					
			6503535960 KIB-M30AS/010-LSD 6503435959 KIB-M30AÖ/010-LSD			

10–60 VDC	10–60 VDC	10–60 VDC	20–265 V AC	10–30 VDC	10–30 VDC
≤ 200 mA	≤ 200 mA	≤ 200 mA	≤ 500 mA	≤ 200 mA	≤ 200 mA
300 Hz	300 Hz	300 Hz	20 Hz	300 Hz	300 Hz
Cyclic	Cyclic	Cyclic	–	Cyclic	Cyclic
LED/–	LED/–	LED/–	LED/–	LED/–	LED/–

–25°C/+70°C	–25°C/+70°C	–25°C/+70°C	–25°C/+70°C	–40°C/+100°	–40°C/+100°
IP67	IP65	IP65	IP65	IP67	IP67
PA, red	PA, red	CuZn39Pb3	CuZn39Pb3	CuZn39Pb3	CuZn39Pb3
3 x 0.5 mm ²	DIN 43650	DIN 43650	DIN 43650	3 x 0.5 mm ²	M12 x 1

You will find detailed data sheets to the products under www.bernstein.eu



Inductive Sensors (Type M30)

Type	M30	M30	M30	M30	
Type of installation	Flush	Non-flush	Non-flush	Non-flush	Non-flush
Nominal sensing distance	10 mm	15 mm	15 mm	15 mm	15 mm
Type of connection	Cable 2 m	Cable 2 m	Cable 2 m	Cable 2.5 m	Connector M12
Special feature	NAMUR				

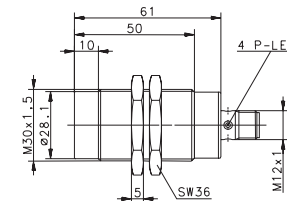
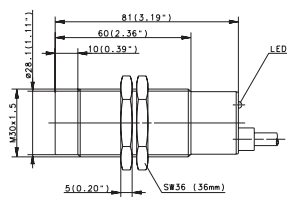
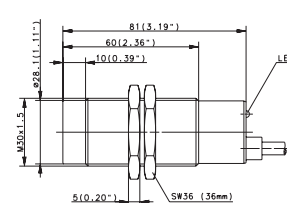
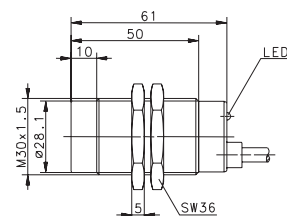
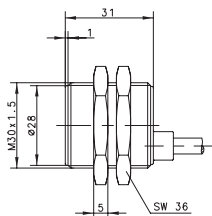

PNP	DC	NO contact Type NC contact Type Antivalent NO/NC Type		6932908001 KIN-M30PS/015-KL2	6502908002 KIN-M30PS/015-KL2		6932908002 KIN-M30PS/015-KLS12 6602308459 KIN-M30NS/015-KLS12
NPN	DC	NO contact Type NC contact Type Antivalent NO/NC			6502808001 KIN-M30PU/015-KL2		
PNP/NPN	DC	NO/NC prog. Type push-pull operation			6502308001 KIN-M30NS/015-KL2		
NAMUR	DC	Type	6501699012 KIB-M30EA/010-2				
Analogue	DC	Type					
2-wire	DC	NO contact NC contact					
	AC	NO contact Type NC contact Changeover contact				6503508246 KIN-M30AS/015-L2,5	

Technical data

Rated operating voltage	U_B	5–25 VDC	10–36 VDC	10–60 VDC	20–250 V AC	10–36 VDC
Rated operating current	I_B	–	≤ 200 mA	≤ 200 mA	≤ 400 mA	≤ 200 mA
Switching frequency (max)	F	≤ 300 Hz	100 Hz	100 Hz	≈ 10 Hz	100 Hz
Short circuit-protection		–	Cyclic	Cyclic	–	Cyclic
Function/operating voltage indicator		–/–	LED/–	LED/–	LED/–	LED/–
Sensing distance, adjustable						

Mechanical data

Ambient temperature (min/max)		–25°C/+70°C	–25°C/+70°C	–25°C/+70°C	–25°C/+70°C	–25°C/+70°C
Protection class in accordance with IEC 529, EN 60529		IP67	IP67	IP67	IP67	IP67
Enclosure material		CuZn39Pb3	CuZn39Pb3	CuZn39Pb3	CuZn39Pb3	CuZn39Pb3
Connection		2 x 0.5 mm ²	3 x 0.5 mm ²	3 x 0.5 mm ²	2 x 0.5 mm ²	M12 x 1

Please refer to Accessories for cable couplers, mounting brackets and sensor tester.



M30		M30		M30		M30	
Non-flush 15 mm	Non-flush 15 mm	Non-flush 15 mm	Non-flush 15 mm	Non-flush 15 mm	Non-flush 40 mm	Non-flush 40 mm	Non-flush 40 mm
Cable 2 m	Cable 2.5 m	DIN Connector	DIN Connector	Connector M12	Cable 2 m	Cable 2 m	Cable 2 m
Plastic	Plastic	Plastic	Plastic	Analogue	Sensing dist.	Sensing dist.	Sensing dist.

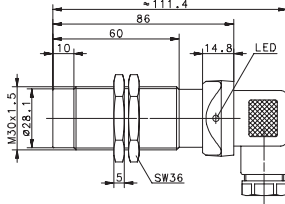
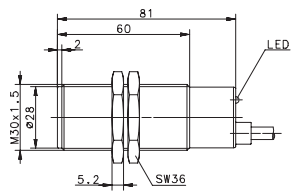
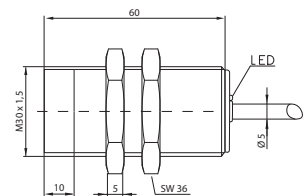
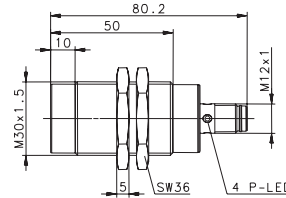
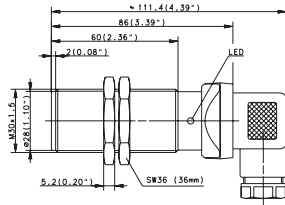
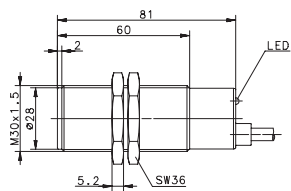

6502923981 KIN-T30PS/015-KL2		6502935001 KIN-M30PS/015-KLSD			6502908009 KIN-M30PS/040-KL2E	
		6502836860 KIN-T30PP/015-KLSD				
				6502008001 KIN-M30PA/015-2		
	6503523956 KIN-T30AS/015-L2,5					

10–60 VDC	20–250 V AC	10–60 VDC	10–60 VDC	10–36 VDC	10–30 VDC
≤ 200 mA	≤ 400 mA	≤ 200 mA	≤ 200 mA	≤ 200 mA	≤ 200 mA
100 Hz	≈ 10 Hz	100 Hz	100 Hz	100 Hz	≤ 100 Hz
Cyclic	–	Cyclic	Cyclic	Cyclic	Cyclic
LED/–	LED/–	LED/–	LED/–	LED/–	LED/–

–25°C/+70°C	–25°C/+70°C	–25°C/+70°C	–25°C/+70°C	–25°C/+70°C	–25°C/+70°C
IP67	IP67	IP65	IP65	IP67	IP67
PA, red	PA, red	PA, red	CuZn39Pb3	CuZn39Pb3	CuZn39Pb3
3 x 0.5 mm ²	2 x 0.5 mm ²	DIN 43650	DIN 43650	M12 x 1	3 x 0.34 mm ²

You will find detailed data sheets to the products under www.bernstein.eu



Inductive Sensors (Type Ø 34 mm, 5 x 5, 8 x 8, 12 x 12, 27 x 10, 28 x 16)

Type	Ø 34 mm	5 x 5 x 25 mm	8 x 8 x 40 mm		8 x 8 x 56 mm
Type of installation	Non-flush	Flush	Flush	Flush	Flush
Nominal sensing distance	20.0 mm	1.5 mm	1.5 mm	1.5 mm	1.5 mm
Type of connection	Cable 2 m	Cable	Cable 2 m	Cable 2 m	Connector M8
Special feature					

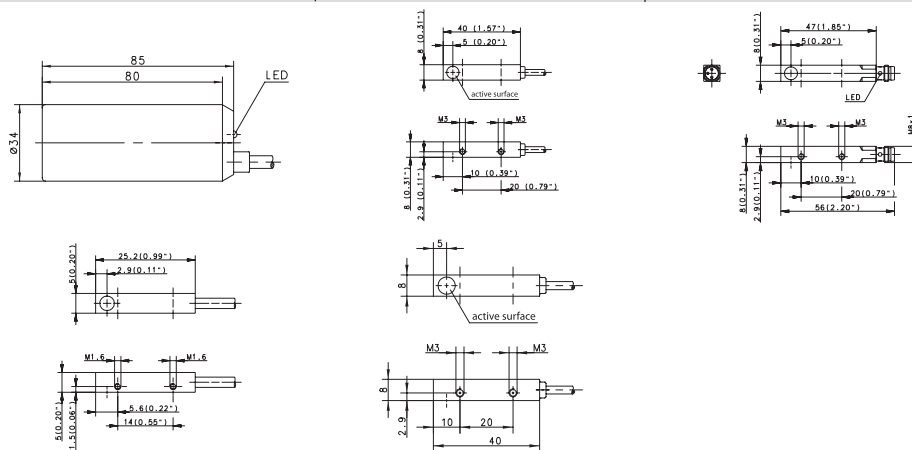

PNP	DC	NO contact Type NC contact Type Antivalent NO/NC	6502915002 KIN-R34PS/020-KL2	6502999026 KIB-Q05PS/001-K2PU 6502799010 KIB-Q05PÖ/001-K2PU	6502980004 KIB-Q08PS/1,5-K2 6502780001 KIB-Q08PÖ/1,5-K2	6602980087 KIB-Q08PS/1,5-K2T	6502980002 KIB-Q08PS/1,5-KLSM8 6502780002 KIB-Q08PÖ/1,5-KLSM8
NPN	DC	NO contact Type NC contact Type Antivalent NO/NC					
PNP/NPN	DC	NO/NC prog. Type push-pull operation	6502915001 KIN-R34PP/020-KLSD				
NAMUR	DC						
Analogue	DC						
2-wire	DC	NO contact NC contact					
	AC	NO contact NC contact Changeover contact					

Technical data

Rated operating voltage	U_B	10–60 VDC	10–30 VDC	10–36 VDC	10–36 VDC	10–36 VDC
Rated operating current	I_B	≤ 200 mA	200 mA	≤ 200 mA	≤ 200 mA	≤ 200 mA
Switching frequency (max)	F	100 Hz	1000 Hz	1000 Hz	1000 Hz	1000 Hz
Short circuit-protection		Cyclic	Cyclic	Cyclic	Cyclic	Cyclic
Function/operating voltage indicator		LED/-	-/-	-/-	-/-	LED/-
Sensing distance, adjustable						

Mechanical data

Ambient temperature (min/max)		-25°C/+70°C	-25°C/+70°C	-25°C/+70°C	0°C/+100°C	-25°C/+70°C
Protection class in accordance with IEC 529, EN 60529		IP67	IP67	IP67	IP67	IP67
Enclosure material		PBT, red	CuZn39PB3	CuZn39Pb3	CuZn39Pb3	CuZn39Pb3
Connection		3 x 0.5 mm ²	3 x 0.05 mm ²	3 x 0.14 mm ²	3 x 0.14 mm ²	M8 x 1

Please refer to Accessories for cable couplers, mounting brackets and sensor tester.



12 x 12 x 55 mm		27 x 10 x 5 mm	28 x 16 x 11 mm	
Flush	Flush	Flush	Flush	Flush
4 mm	4 mm	1.5 mm	2 mm	2 mm
Cable 2 m	Connector M8	Cable 2 m	Cable 2 m	Connector M8

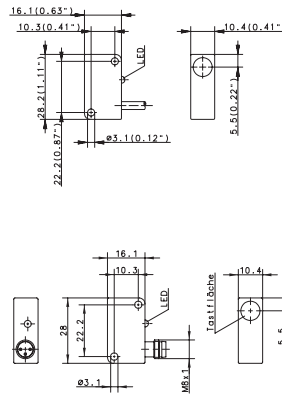
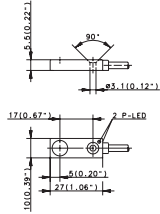
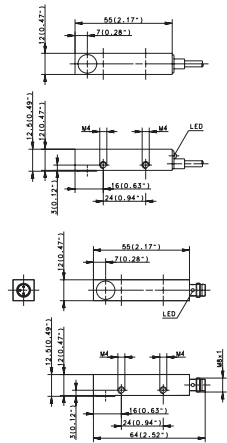

6502999028 KIB-Q12PS/004-KL2E	6502999030 KIB-Q12PS/004-KLSM8E	6502993001 KIB-E27PS/1,5-KL2PU	6502973001 KIB-E28PS/002-KL2	6502973002 KIB-E28PS/002-KLSM8 6502773001 KIB-E28PÖ/002-KLSM8		
	6502399021 KIB-Q12NS/004-KLSM8E					

10–60 VDC	10–60 VDC	10–30 VDC	10–30 VDC	10–30 VDC
≤ 200 mA	≤ 200 mA	≤ 200 mA	≤ 200 mA	≤ 200 mA
800 Hz	800 Hz	1000 Hz	800 Hz	800 Hz
Cyclic	Cyclic	Cyclic	Cyclic	Cyclic
LED/-	LED/-	LED/-	LED/-	LED/-

-25°C/+70°C	-25°C/+70°C	-25°C/+70°C	-25°C/+70°C	-25°C/+70°C
IP67	IP67	IP67	IP67	IP67
CuZn39Pb3	CuZn39Pb3	PA, black	PA, black	PA, black
3 x 0.14 mm ²	M8 x 1	3 x 0.14 mm ²	3 x 0.14 mm ²	M8 x 1

You will find detailed data sheets to the products under www.bernstein.eu



Inductive Sensors (Type 28 x 16 mm, 40 x 26 mm, 50 x 25 mm, 60 x 36 mm)

Type	40 x 26 x 12 mm		40 x 26 x 12 mm		40 x 26 x 12 mm	
Type of installation	Flush	Flush	Flush	Non-flush	Non-flush	Non-flush
Nominal sensing distance	2 mm	2 mm	2 mm	4 mm	4 mm	4 mm
Type of connection	Cable 2 m	Cable 2 m	Connector M8	Cable 2 m	Cable 2 m	Connector M8
Special feature						

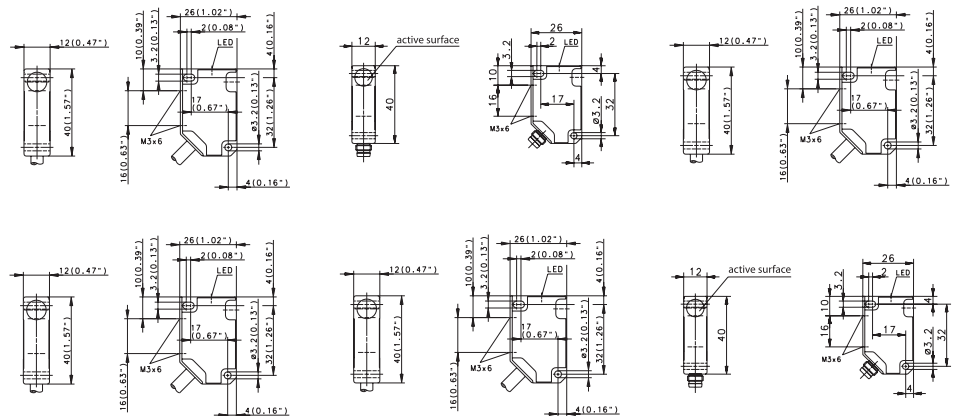

PNP	DC	NO contact Type NC contact Type Antivalent NO/NC Type	6502984023 KIB-E40PS/002-KL2 6502784006 KIB-E40PÖ/002-KL2	6502984025 KIB-E40PS/002-KLSM8	6502984024 KIN-E40PS/004-KL2 6502784007 KIN-E40PÖ/004-KL2	6502984026 KIN-E40PS/004-KLSM8 6502784008 KIN-E40PÖ/004-KLSM8
NPN	DC	NO contact Type NC contact Antivalent NO/NC Type				
PNP/NPN	DC	NO/NC prog. Type push-pull operation				
NAMUR	DC	Type				
Analogue	DC	Type				
2-wire	DC	NO contact NC contact				
	AC	NO contact Type NC contact Changeover contact	6503584004 KIB-E40AS/002-L2			6503584005 KIN-E40AS/004-L2

Technical data

Rated operating voltage	U_B	10–36 VDC	20–250 V AC	10–36 VDC	10–36 VDC	20–250 V AC	10–36 VDC
Rated operating current	I_B	≤ 200 mA	≤ 300 mA	≤ 200 mA	≤ 200 mA	≤ 300 mA	≤ 200 mA
Switching frequency (max)	F	800 Hz	10 Hz	800 Hz	400 Hz	10 Hz	400 Hz
Short circuit-protection		Cyclic	–	Cyclic	Cyclic	–	Cyclic
Function/operating voltage indicator		LED/–	LED/–	LED/–	LED/–	LED/–	LED/–
Sensing distance, adjustable							

Mechanical data

Ambient temperature (min/max)		–25°C/+70°C	–25°C/+70°C	–25°C/+70°C	–25°C/+70°C	–25°C/+70°C	–25°C/+70°C
Protection class in accordance with IEC 529, EN 60529		IP67	IP67	IP67	IP67	IP67	IP67
Enclosure material		PBT, black	PBT, black	PBT, black	PBT, black	PBT, black	PBT, black
Connection		3 x 0.5 mm ²	2 x 0.5 mm ²	M8 x 1	3 x 0.5 mm ²	2 x 0.5 mm ²	M8 x 1

Please refer to Accessories for cable couplers, mounting brackets and sensor tester.



50 x 25 x 10 mm		50 x 25 x 10 mm		60 x 36 x 10 mm	
Flush	Flush	Non-flush	Non-flush	Non-flush	
5 mm	5 mm	8 mm	8 mm	8 mm	
Cable 2 m	Connector M8	Cable 2 m	Connector M8	Connector M8	

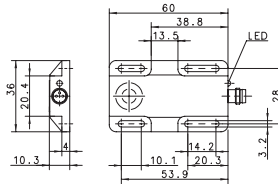
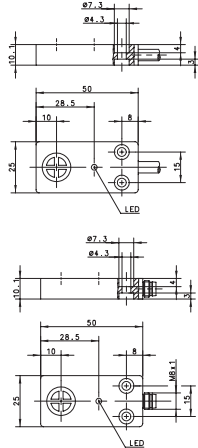
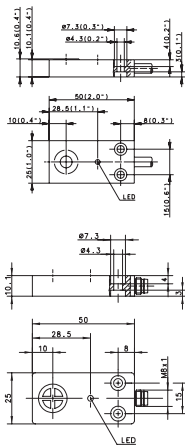

6502990001 KIB-E50PS/005-KL2	6502990005 KIB-E50PS/005-KLSM8	6502990003 KIN-E50PS/008-KL2 6502790002 KIN-E50PÖ/008-KL2	6502990006 KIN-E50PS/008-KLSM8	6602799048 KIN-E60PÖ/008-KLSM8		
6502390001 KIB-E50NS/005-KL2		6502390002 KIN-E50NS/008-KL2				

10–60 VDC	10–60 VDC	10–60 VDC	10–60 VDC	10–60 VDC
≤ 200 mA	≤ 200 mA	≤ 200 mA	≤ 200 mA	≤ 400 mA
500 Hz	500 Hz	200 Hz	200 Hz	200 Hz
Cyclic	Cyclic	Cyclic	Cyclic	Cyclic
LED/–	LED/–	LED/–	LED/–	LED/–

–25°C/+70°C	–25°C/+70°C	–25°C/+70°C	–25°C/+70°C	–25°C/+70°C
IP67	IP67	IP67	IP67	IP67
PA, black	PA, black	PA, black	PA, black	PA, black
3 x 0.5 mm ²	M8 x 1	3 x 0.5 mm ²	M8 x 1	M8 x 1

You will find detailed data sheets to the products under www.bernstein.eu



Inductive Sensors (Type 68 x 30 mm, 40 x 40 mm)

Type	68 x 30 x 15 mm	40 x 40 mm	40 x 40 mm	
Type of installation	Non-flush	Non-flush	Non-flush	Non-flush
Nominal sensing distance	7 mm	20 mm	15 mm	0 mm
Type of connection	Cable 2 m	Connector M12	DIN Connector	Cable 6 m
Special feature				Ring sensor

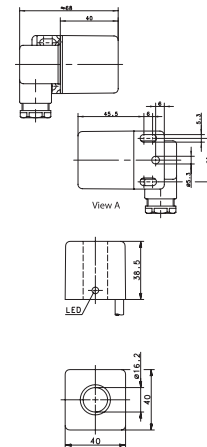
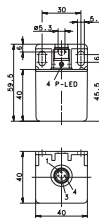
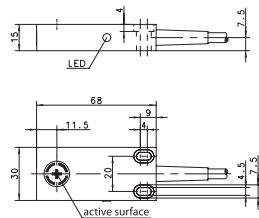

PNP	DC	NO contact Type NC contact Type Antivalent NO/NC	6502956076 KIN-E68PS/007-KL2	6502982003 KIN-N40PS/020-KLS12	6502999036 KIR-N40PS/000-KL6
NPN	DC	NO contact Type NC contact Type Antivalent NO/NC	6502156058 KIN-E68NÖ/007-KL6		
PNP/NPN	DC	NO/NC prog. Type push-pull operation			6502982001 KIN-N40PP/015-KLSD
NAMUR	DC				
Analogue	DC				
2-wire	DC	NO contact NC contact			
	AC	NO contact NC contact Changeover contact			

Technical data

Rated operating voltage	U_B	10–60 VDC	10–36 VDC	10–60 VDC	10–30 VDC
Rated operating current	I_B	≤ 200 mA	≤ 200 mA	≤ 400 mA	≤ 200 mA
Switching frequency (max)	F	200 Hz	50 Hz	100 Hz	–
Short circuit-protection		Cyclic	Cyclic	Cyclic	Cyclic
Function/operating voltage indicator		LED/–	LED/–	LED/–	LED/–
Sensing distance, adjustable					

Mechanical data

Ambient temperature (min/max)		–25°C/+70°C	–25°C/+70°C	–25°C/+70°C	–25°C/+70°C
Protection class in accordance with IEC 529, EN 60529		IP67	IP67	IP65	IP67
Enclosure material		PBT, black	PA, red/black	PA, red	PA, black
Connection		3 x 0.5 mm ²	M12 x 1	DIN 43650	3 x 0.5 mm ²

Please refer to Accessories for cable couplers, mounting brackets and sensor tester.



Capacitive Sensors

Functional principle

Capacitive proximity switches detect conductive and non-conductive materials that can be in a solid or liquid state. They serve the purpose of monitoring product levels in containers, checking contents in filling and packaging systems as well as detecting, positioning, monitoring and counting objects, e.g. in sequence control systems, conveyor belts.

Used for detecting media such as:

- **solid:**
wood, ceramic, glass, paper stacks, plastic, stone, rubber, ice, nonferrous metals, potatoes
- **liquid:**
water, oil, beverages, adhesives, paints
- **granular:**
plastic pellets, granulated products, grain, fodder, wood chip
- **powder:**
dyes, detergents, sand, cement, fertilizer, salt, sugar, flour, coffee

Technical description

The function of the capacitive proximity switch is based on evaluating the influence exerted by an actuator on the electrical field at the active face of the switch. The approach of an influencing object increases the capacitance of the capacitor, which consists of a sensor electrode located behind the active face and the actuator connected to earth / mass. This increase in capacitance is dependent on the conductance and the dielectric constant of the actuator as well as its mass, surface area and its distance from the sensor electrode. The capacitive limit switch is equipped with an RC oscillator with a gain factor that increases as a result of the rise in capacitance of the previously described capacitor to such an extent that oscillation is induced. In limit switches, the capacitance required to induce oscillation can be determined by the built-in potentiometer intervening in the feedback of the oscillator.

The response sensitivity, i.e. the sensing distance with a given actuator can be adjusted in this way. The oscillator output signal is fed to an evaluation circuit that actuates the switching amplifier.

In response to the approach of **conductive** material the actuating object and the active face of the sensor form the plates of a capacitor. The change in capacitance and the consequently achievable sensing distance are large.

In response to the approach of **non-conductive** material $\epsilon > 1$ only the change in the dielectric constant is effective. The increase in capacitance is less than is the case for conductive materials. The resulting sensing distance is small.

Sensitivity table	
St37 or other metals, earthed	1.00
Surface of water	1.00
St37 150 x 150 x 1 mm, not earthed	0.85
Marble 150 x 150 x 12.5 mm	0.65
Glass 150 x 150 x 7.5 mm	0.55
Stack of paper DIN A 4, 80 g/m ² , 500 sheets	0.55
Fibre board 150 x 150 x 16 mm	0.45
Ceramic tile 150 x 150 x 6 mm	0.25
PVC 150 x 150 x 4 mm	0.15

These values only indicate the expected magnitude of the response sensitivity as the specific properties of the actuating object and of the surroundings in actual applications have a considerable influence on the response distance. It is important to take into account the influence of moisture in order to ensure trouble-free operation. A high water content in the material to be detected, e.g. wood or paper, increases the sensing distance considerably.

In terms of capacitive proximity switches a distinction is made between

- flush mount and
 - non-flush mount
- limit switches.

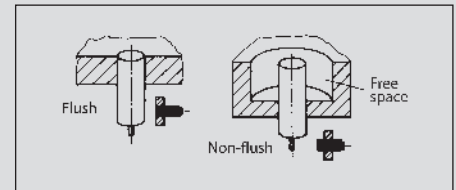

In the case of non-flush mount limit switches a clearance that must contain no influencing material must be created about the switch. Due to the adjustment facility available in capacitive proximity switches, the installation of non-flush mount devices is not problematic in connection with reduced clearance. Non-flush mount capacitive proximity switches are characterised by low sensitivity to soiling or condensation.

A screening electrode built into flush mount limit switches is connected to circuit ground. As both electrodes of the capacitor are now close together, flush mount capacitive proximity switches are particularly suitable for sensing dielectrics. The disadvantage is that this configuration has an increased sensitivity to condensation or soiling.

Capacitive proximity switches can mutually influence each other if they are mounted next to or opposite each other. In such configurations, the response of flush mount switches is considerably less sensitive than non-flush mount switches. Trials under actual application conditions should be carried out at distances from $> 2x$ to $< 8x$ enclosure diameter. Arrangements with distances $> 8x$ enclosure diameter are not problematic.

Active face: The active face of a capacitive proximity switch is the point at which the electrical field emerges. This point is located at the end face on types designed as threaded sleeves or smooth cylinders. Non-cylindrical limit switches are identified by a symbol on the corresponding face.

Influencing: In relation to a capacitive proximity switch the term influencing refers to the change in the switching status in response to the medium to be detected entering the electrical field.

Standard target: The standard target is defined as a square plate, 1 mm thick and made from FE 360.

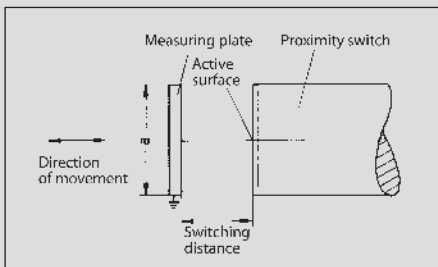

The side length "a" of the square target corresponds to the diameter of the circle described by the active face. The length of its side is defined as the larger of either the active face diameter or three times the nominal sensing distance. The target must be earthed in order to ensure comparable sensing distances. The sensing distance of rectangular, capacitive proximity switches is determined by means of an earthed target with a size equal to the surface of the active side of the limit switch.

Sensing distance: The sensing distance, that changes the status of the output stage, is the distance of the influencing object in relation to the active face.

Nominal sensing distance (s_n): This is a device-specific characteristic value that does not take into account influences such as tolerance, temperature and changes in voltage.

Real sensing distance (s_r): The real sensing distance is measured at a rated voltage and an ambient temperature of 23 °C +/- 5 °C. It must be between 90 % and 110 % of the nominal sensing distance.

Useable sensing distance (s_u): The useable sensing distance is measured within the permissible temperature and voltage ranges and is 80 % – 120 % of the real sensing distance.

Assured sensing distance (s_a) (operational sensing distance): This is the distance that can be used effectively under the influence of temperature, voltage as well as tolerance variables. It is between 0 % and 72 % of the nominal sensing distance.

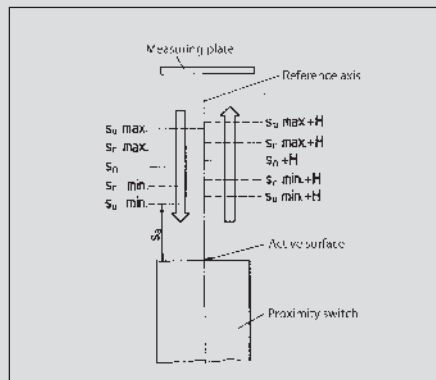

Reproducibility: The reproducibility of the switching distance is the repeat accuracy of the real sensing distance of two successive switching operations within a period of 8 hours at an ambient temperature between 18 °C and 28 °C and a supply voltage that may not deviate by more than 5 % from the rated voltage. The difference between any two measurements must not be more than 10 % of the real sensing distance.

Switching hysteresis: The switching hysteresis refers to the difference between the switch-on point as an object approaches the target and the switch-off point as the object moves away from the proximity switch. The value is specified as a percentage of the real sensing distance.

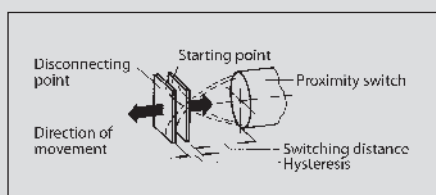

Switching frequency: The switching frequency is measured in accordance with EN 60947-5-2. The standard targets with the side length "a" are mounted on a plate that exerts minimum influence at "2a" intervals and are moved passed the proximity switch to be tested at half the nominal sensing distance. The maximum switching frequency is reached when the switch-on or switch-off time of the proximity switch is 50 µs. In the case of AC proximity switches, the maximum switching frequency is reached when the switch-on and switch-off time is equal to the half wave period of the supply frequency.

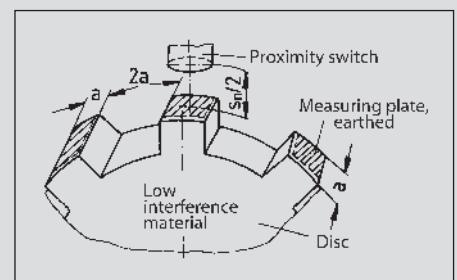

Temperature range: In accordance with DIN, the temperature range is from -25 °C to +70 °C. Reliable operation is ensured within this range.

Protection class

Corresponding to their ID code, the enclosures are dustproof and waterproof in accordance with IP 65 or IP 67 (DIN 40050).

Connection cable

A PVC-insulated connection cable is supplied as standard. Special versions with silicone sheathing, polyurethane sheathing, irradiation cross-linked PVC or Teflon insulation are also available.

Plug connection

Nowadays the plug connection is just as significant as the fixed cable on electronic proximity switches. The capacitive proximity switches in the BERNSTEIN range can be equipped with a wide variety of plug connections. As standard, this catalogue contains connector versions of virtually all types of limit switch.

Standards

All sensors conform to EN 60947-5-2



Capacitive Sensors

Important information

Capacitive sensors are able to detect conductive and non-conductive materials in solid, liquid, granular or powder form. However, certain criteria must be taken into account in practical applications.

Sensing distance

The nominal sensing distances are specified and set at the factory in accordance with DIN EN 60947-5-2/98. The maximum sensing distance is achieved on approach of **conductive** materials of corresponding size.

On approach of **non-conductive** materials, the dielectric constant ϵ of the material to be detected is of decisive significance. Depending on the application, the specified sensing distances vary by a certain factor in relation to the dielectric constant. The values determined according to the table only indicate the expected magnitude of the response sensitivity as the specific properties of the actuating object (diameter, thickness, moisture content etc.) and of the surroundings (earthing) in actual applications have a considerable influence on the response distance. In most cases adaptation to the specific application can be achieved by adjustment with the built-in potentiometer.

Clearance

In the case of non-flush mount capacitive sensors a clearance that must contain no influencing material must be created about the sensor. Non-flush mount capacitive sensors are characterised by low sensitivity to soiling or condensation. On account of their design, flush mount capacitive sensors are particularly suitable for sensing dielectrics. The increased sensitivity, however, may be detrimental in terms of the above mentioned parasitic effects.

If capacitive proximity switches are to be mounted opposite or next to each other, trials under actual application conditions should be carried out at distances between 2x and 8x enclosure diameter. Thanks to the adjustment facility, however, adaptation to specific applications is almost always possible.

Examples of dielectric constants	
Glass	3 ... 14
Rubber	2.5 ... 3
Laminated paper	3.5 ... 6
Wood	2.5 ... 6.8
Marble	8.4 ... 14
Mineral oil	2.15
Epoxy resin	3.3 ... 3.6
Petroleum	2.2
Plexiglas	3.6
Polyamide	3 ... 8
PVC	3.3 ... 4.1
Porcelain	4.2 ... 6.5
Teflon PTFE	2
Air	1
Water	80.8
Paper (dry)	2

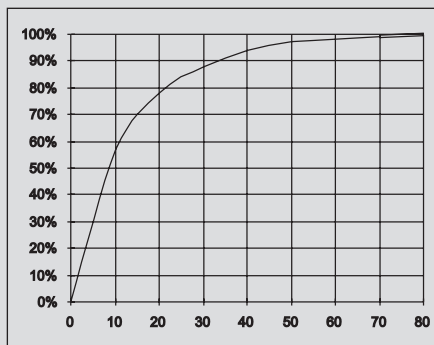

Variance of sensing distance as a function of ϵ







Application descriptions

A particular application of capacitive proximity switches is to detect levels in non-metallic containers from the outside. Advantage: There is no need to make a hole in the container wall for the purpose of detecting product level. The medium to be detected does not come in contact with the limit switch. The prerequisite is that the dielectric constant and the mass of the material to be detected are greater than that of the container. The response sensitivity of the proximity switch must be reduced with the built-in potentiometer to such an extent that the limit switch does not respond to the container wall but rather to the medium to be detected.

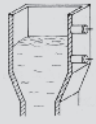
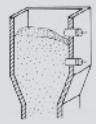
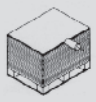

Above: Insulation glass production lines equipped with BERNSTEIN capacitive sensors

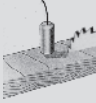
Further fields of application are illustrated below.

- 
Level monitoring in non-metallic containers
- 
Level monitoring of bulk material, e.g. granulated material, fodder
- 
Stack height scanning, e.g. paper, chip board
- 
Fill level monitoring in paint and adhesive containers
- 
Registering, counting, sorting or monitoring in conveyor belt systems
- 
Detecting, positioning in sequence control systems
- 
Detection in woodworking applications
- 
Belt breakage signalling
- 
Level monitoring in packing systems

Capacitive Sensors (Type M12, M18)

Type	M12		M12		M12
Type of installation	Flush	Flush	Non-flush	Non-flush	Non-flush
Nominal sensing distance	2 mm	2 mm	4 mm	4 mm	6 mm
Type of connection	Cable 2 m	Connector M8	Cable 2 m	Connector M8	Cable 2 m
Special feature					Sensing dist.

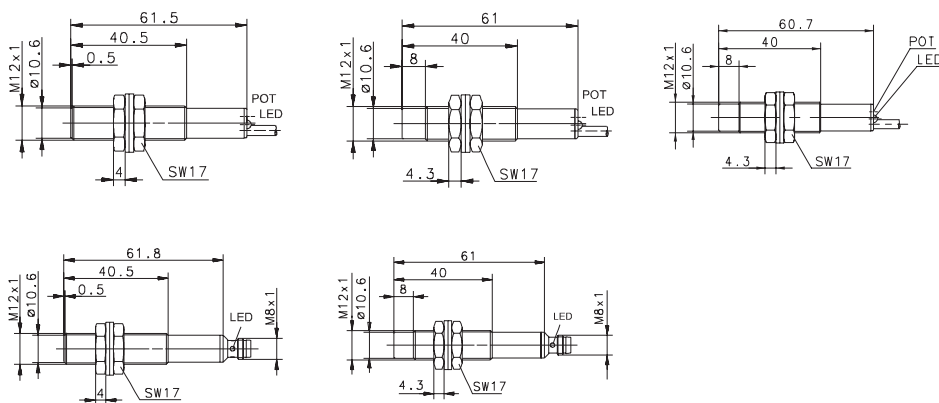

PNP	DC	NO contact	6507903001	6507903004	6507919001	6507919004	6607919110
		Type	KCB-M12PS/002-KLP2	KCB-M12PS/002-KLSM8	KCN-T12PS/004-KLP2	KCN-T12PS/004-KLSM8	
NPN	DC	NC contact	6507703001				
		Type	KCB-M12PÖ/002-KLP2				
PNP/NPN	DC	Antivalent NO/NC					
		Type					
NAMUR	DC	Antivalent NO/NC					
		Type					
Analogue	DC	NO/NC prog.					
		push-pull operation					
2-wire	DC	NO contact	6507303001		6507319001		
		NC contact	KCB-M12NS/002-KLP2		KCN-T12NS/004-KLP2		
	AC	NO contact					
		NC contact					
		Type					
		NC contact					
		Type					
		Changeover contact					

Technical data

Rated operating voltage	U_B	10–36 VDC	10–36 VDC	10–36 VDC	10–36 VDC	10–36 VDC
Rated operating current	I_B	≤ 200 mA	≤ 200 mA	≤ 200 mA	≤ 200 mA	≤ 200 mA
Switching frequency (max)	F	25 Hz	25 Hz	25 Hz	25 Hz	25 Hz
Short circuit-protection		Cyclic	Cyclic	Cyclic	Cyclic	Cyclic
Function/operating voltage indicator		LED/-	LED/-	LED/-	LED/-	LED/-
Sensing distance, adjustable		Poti	-	Poti	-	Poti

Mechanical data

Ambient temperature (min/max)		-25°C/+70°C	-25°C/+70°C	-25°C/+70°C	-25°C/+70°C	-25°C/+70°C
Protection class in accordance with IEC 529, EN 60529		IP65	IP65	IP65	IP65	IP65
Enclosure material		CuZn39Pb3	CuZn39Pb3	PBT, black	PBT, black	PBT, black
Connection		3 x 0.14 mm ²	M8 x 1	3 x 0.14 mm ²	M8 x 1	3 x 0.14 mm ²

Please refer to Accessories for cable couplers, mounting brackets and sensor tester.



M18		M18		M18	
Flush	Flush	Non-flush	Non-flush	Non-flush	Non-flush
5.0 mm	5.0 mm	8.0 mm	8.0 mm	8.0 mm	13.5 mm
Cable 2 m	Connector M8	Cable 2 m	Cable 2 m	Connector M8	Connector M12
					Sensing dist.

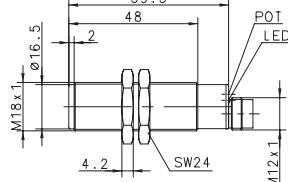
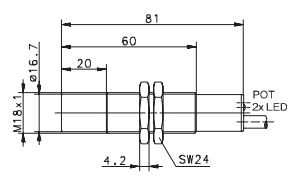
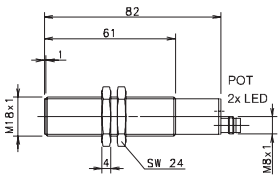
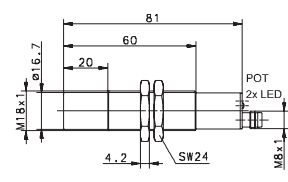
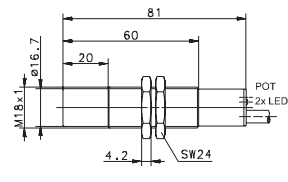
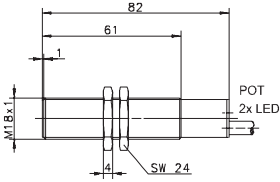

6507905001 KCB-M18PS/005-KLP2	6507905004 KCB-M18PS/005-KLPSM8	6507921724 KCN-T18PS/008-KLP2		6507921002 KCN-T18PS/008-KLPSM8	6507921004 KCN-T18PS/013-KLPS12V	
		6507821001 ^① KCN-T18PU/008-KLP2V				
6507305001 KCB-M18NS/005-KLP2		6507321723 KCN-T18NS/008-KLP2				
			6508521001 KCN-T18AS/008-LP2			
			6508421001 KCN-T18AÖ/008-LP2			

10-60 VDC	10-60 VDC	10-60 VDC	20-250 V AC	10-60 VDC	10-60 VDC
≤ 200 mA	≤ 200 mA	≤ 200 mA	≤ 300 mA	≤ 200 mA	≤ 200 mA
25 Hz	25 Hz	25 Hz	15 Hz	25 Hz	25 Hz
Cyclic	Cyclic	Cyclic	-	Cyclic	Cyclic
LED/LED	LED/LED	LED/LED	LED/LED	LED/LED	LED/LED
Poti	Poti	Poti	Poti	Poti	Poti

-25°C/+70°C	-25°C/+70°C	-25°C/+70°C	-25°C/+70°C	-25°C/+70°C	-25°C/+70°C
IP65	IP65	IP65	IP65	IP65	IP65
CuZn39Pb3	CuZn39Pb3	PBT, black	PBT, black	PBT, black	PBT, black
3 x 0.5 mm ²	M8 x 1	3 x 0.5 mm ²	2 x 0.5 mm ²	M8 x 1	M12 x 1

You will find detailed data sheets to the products under www.bernstein.eu

① Length 65 mm



Capacitive Sensors (Type M30, M32)

Type	M30		M30		M30	
Type of installation	Flush	Flush	Non-flush	Non-flush	Non-flush	Non-flush
Nominal sensing distance	10 mm	10 mm	20 mm	20 mm	20 mm	20 mm
Type of connection	Cable 2 m	Connector M12	Cable 2 m	Connector M12	Connector M12	Cable 2 m
Special feature					Short form	

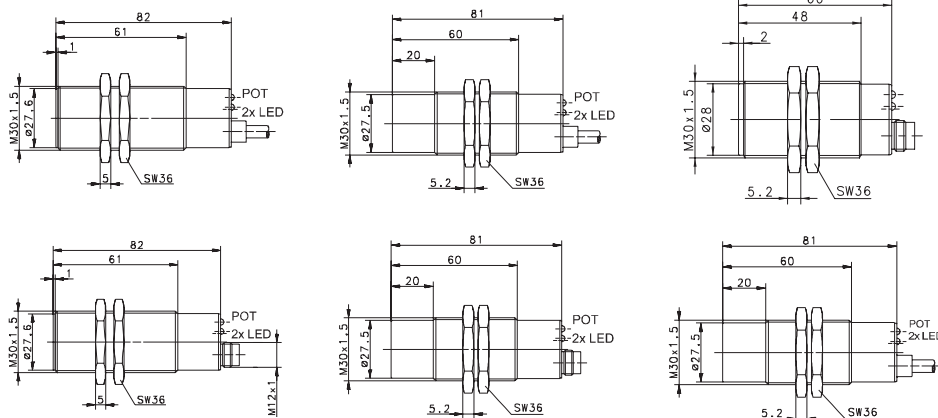

PNP	DC	NO contact Type NC contact Antivalent NO/NC Type	6507907001 KCB-M30PS/010-KLP2	6507907004 KCB-M30PS/010-KLPS12	6507923727 KCN-T30PS/020-KLP2	6507923004 KCN-T30PS/020-KLPS12	6507923006 KCN-T30PS/020-KLPS12V
NPN	DC	NO contact Type NC contact Antivalent NO/NC Type	6507707001 KCB-M30PÖ/010-KLP2		6507323001 KCN-T30NS/020-KLP2		
PNP/NPN	DC	NO/NC prog. Type push-pull operation Type					
NAMUR	DC						
Analogue	DC						
2-wire	DC	NO contact NC contact					
	AC	NO contact Type NC contact Type Changeover contact Type					6508523001 KCN-T30AS/020-LP2 6508423001 KCN-T30AÖ/020-LP2

Technical data

Rated operating voltage	U_B	10–60 VDC	10–60 VDC	10–60 VDC	10–60 VDC	10–60 VDC	20–250 V AC
Rated operating current	I_B	≤ 400 mA	≤ 400 mA	≤ 400 mA	≤ 400 mA	≤ 400 mA	≤ 300 mA
Switching frequency (max)	F	25 Hz	25 Hz	25 Hz	25 Hz	25 Hz	15 Hz
Short circuit-protection		Cyclic	Cyclic	Cyclic	Cyclic	Cyclic	–
Function/operating voltage indicator		LED/LED	LED/LED	LED/LED	LED/LED	LED/LED	LED/LED
Sensing distance, adjustable		Poti	Poti	Poti	Poti	Poti	Poti

Mechanical data

Ambient temperature (min/max)		–25°C/+70°C	–25°C/+70°C	–25°C/+70°C	–25°C/+70°C	–25°C/+70°C	–25°C/+70°C
Protection class in accordance with IEC 529, EN 60529		IP65	IP65	IP65	IP65	IP65	IP65
Enclosure material		CuZn39Pb3	CuZn39Pb3	PBT, black	PBT, black	PBT, black	PBT, black
Connection		3 x 0.5 mm ²	M12 x 1	3 x 0.5 mm ²	M12 x 1	M12 x 1	2 x 0.5 mm ²

Please refer to Accessories for cable couplers, mounting brackets and sensor tester.



M32		M32		M32	
Flush	Flush	Non-flush	Non-flush	Non-flush	
15 mm	15 mm	30 mm	30 mm	30 mm	
Cable 6 m	Connector M12	Cable 2 m	Connector M12	Cable 2 m	Timer/Relay

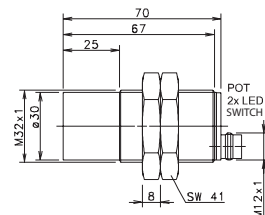
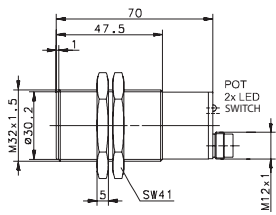
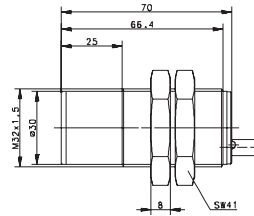
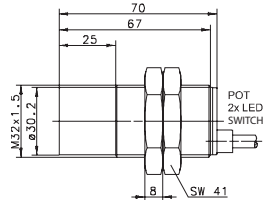
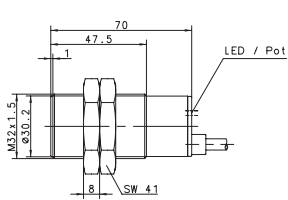

6507013013 KCB-M32DP/015-KLP6	6507013015 KCB-M32DP/015-KLPS12	6507013001 KCN-T32DP/030-KLP2	6507013004 KCN-T32DP/030-KLPS12		
6507013012 KCB-M32GP/015-KLP2					
				6508613001 KCN-T32RU/030-LP2	

10–60 VDC	10–60 VDC	10–60 VDC	10–60 VDC	180–250 V AC
≤ 400 mA	≤ 400 mA	≤ 400 mA	≤ 400 mA	≤ 8 A
25 Hz	25 Hz	25 Hz	25 Hz	–
Cyclic	Cyclic	Cyclic	Cyclic	–
LED/LED	LED/–	LED/–	LED/–	LED/LED
Poti	Poti	Poti	Poti	Poti

–25°C/+70°C	–25°C/+70°C	–25°C/+70°C	–25°C/+70°C	–25°C/+70°C
IP65	IP65	IP65	IP65	IP65
CuZn39Pb3	CuZn39Pb3	PBT, black	PBT, black	PBT, black
3 x 0.5 mm ²	M12 x 1	3 x 0.5 mm ²	M12 x 1	5 x 0.5 mm ²

You will find detailed data sheets to the products under www.bernstein.eu



Capacitive Sensors (Type Ø 20 mm, Ø 34 mm, E50, E68)

Type	Ø 20 mm		Ø 20 mm	Ø 34 mm	
Type of installation	Non-flush	Non-flush	Non-flush	Flush	Non-flush
Nominal sensing distance	15 mm	15 mm	15 mm	20 mm	30 mm
Type of connection	Cable 2 m	Cable 2 m	Connector M8	Connector M12	Cable 2 m
Special feature					

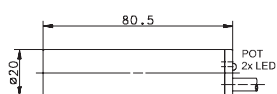
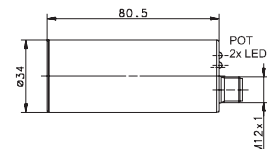
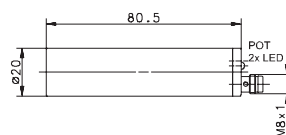
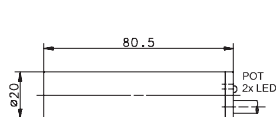

PNP	DC	NO contact Type NC contact Antivalent NO/NC	6507910001 KCN-R20PS/015-KLP2	6507910004 KCN-R20PS/015-KLP5M8	6507915006 KCB-D34PS/020-KLP512	6507915001 KCN-R34PS/030-KLP2
NPN	DC	NO contact Type NC contact Antivalent NO/NC				6507315001 KCN-R34NS/030-KLP2
PNP/NPN	DC	NO/NC prog. push-pull operation				
NAMUR	DC					
Analogue	DC					
2-wire	DC	NO contact NC contact				
	AC	NO contact Type NC contact Type Changeover contact	6508410001 KCN-R20AÖ/015-LP2			

Technical data

Rated operating voltage	U_B	10–60 VDC	20–250 V AC	10–60 VDC	10–60 VDC	10–60 VDC
Rated operating current	I_B	≤ 400 mA	≤ 300 mA	≤ 400 mA	≤ 200 mA	≤ 400 mA
Switching frequency (max)	F	25 Hz	15 Hz	25 Hz	25 Hz	25 Hz
Short circuit-protection		Cyclic	–	Cyclic	Cyclic	Cyclic
Function/operating voltage indicator		LED/LED	LED/LED	LED/LED	LED/LED	LED/LED
Sensing distance, adjustable		Poti	Poti	Poti	Poti	Poti

Mechanical data

Ambient temperature (min/max)		–25°C/+70°C	–25°C/+70°C	–25°C/+70°C	–25°C/+70°C	–25°C/+70°C
Protection class in accordance with IEC 529, EN 60529		IP65	IP65	IP65	IP65	IP65
Enclosure material		PBT, red	PBT, red	PBT, red	CuZn39Pb3	PBT, red
Connection		3 x 0.5 mm ²	2 x 0.5 mm	M8 x 1	M12 x 1	3 x 0.5 mm ²

Please refer to Accessories for cable couplers, mounting brackets and sensor tester.



Ø 34 mm		E50	E68
Non-flush 30 mm	Non-flush 30 mm	Flush 8 mm	Flush 10 mm
Connector M12	Cable 2 m	Cable 2 m	Cable 2 m

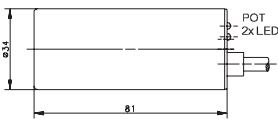
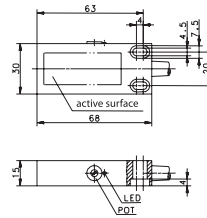
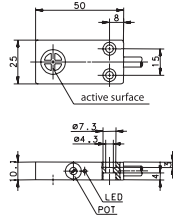
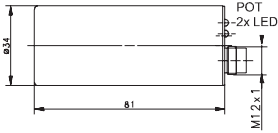

6507915004 KCN-R34PS/030-KLPS12	6507990001 KCB-E50PS/008-KLP2	6507956001 KCB-E68PS/010-KLP2		
	6507390001 KCB-E50NS/008-KLP2			
	6508515001 KCN-R34AS/030-LP2 6508415001 KCN-R34AÖ/030-LP2			

10–60 VDC	20–250 V AC	10–36 VDC	10–36 VDC
≤ 400 mA	≤ 300 mA	≤ 200 mA	≤ 200 mA
25 Hz	15 Hz	25 Hz	25 Hz
Cyclic	–	Cyclic	Cyclic
LED/LED	LED/LED	LED/–	LED/–
Poti	Poti	Poti	Poti

–25°C/+70°C	–25°C/+70°C	–25°C/+70°C	–25°C/+70°C
IP65	IP65	IP65	IP65
PBT, red	PBT, red	PBT, black	PBT, black
M12 x 1	2 x 0.5 mm ²	3 x 0.34 mm ²	3 x 0.5 mm ²

You will find detailed data sheets to the products under www.bernstein.eu



Optoelectronic Sensors

BERNSTEIN optoelectronic sensors can be divided into three basic types (operating modes):

- Through-beam sensor **Type T**
- Retro-reflective sensor **Type R**
- Diffuse-reflection sensor **Type D**

In accordance with EN 60947-5-2 the sensors are described as “photoelectric proximity switches” and CE-certified.

The use of the sensor systems depends primarily on the specific application and operating environment.

Several applications are outlined on these pages, illustrating the advantages and disadvantages of the individual operating modes.

Dividing all optoelectronic sensors into type groups simplifies device selection. The distinguishing criteria for the type families are the shape and material of the enclosure. The available operating modes of the individual type groups are specified in the Technical Data section of this catalogue.

In general, BERNSTEIN optoelectronic sensors operate using pulsating red or infrared light. This technology offers the following advantages:

- High immunity to ambient light
- Maximum sensing range
- Lower heat built-up and therefore longer service life of transmit diodes

Through-beam sensors

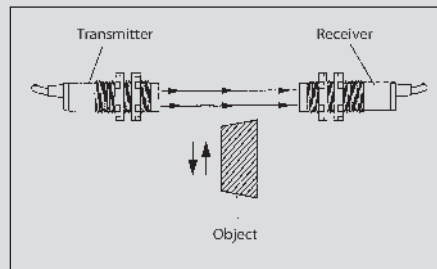

Through-beam sensors consist of a light transmitter (light source) and a spatially separated receiver. The light emitted by the transmitter is analysed by the receiver. An interruption in the light path, e.g. by an object, is evaluated and causes the output to switch.

Advantages:

- Long sensing distance; the light beam needs only to travel in one direction from the transmitter to the receiver
- High operational reliability; interference reflections rarely trigger the receiver
- Detection of even the smallest objects by additionally mounting lenses or screens

Disadvantages:

- High installation cost with two devices having to be mounted, wired and adjusted

Retro-reflective sensors

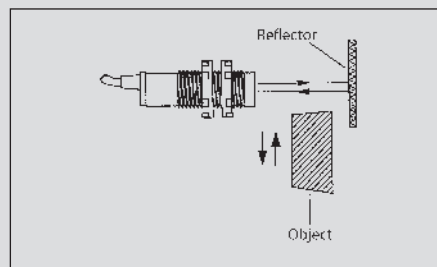

The light transmitter and receiver in retro-reflective sensors are accommodated in one enclosure. The light beam emitted by the transmitter is reflected back to the receiver by a reflector (e.g. triple reflector or reflective film). An interruption in the light paths is evaluated and changes the output signal at the receiver.

The ranges of these types of sensor specified in the Technical Data section in this catalogue relate to an 83 mm diameter triple reflector. Different ranges by using other types or sizes of reflector are available on request.

Advantages:

- Easy installation of light barrier and reflector
- The reflector can be used as a moving signal generator, e.g. in conveyor systems

Disadvantages:

- Shorter sensing range than a through-beam system since the light beam has to travel from the transmitter (light source) to the reflector and back to the receiver
- Highly polished objects can act as reflectors and may cause malfunctions

Retro-reflective sensors with polarisation filter

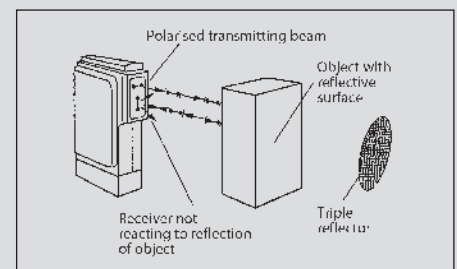

This is a special type of retro-reflective sensor. A special linear or circular polarised filter element (film) is placed between the transmit or receive elements and the glass light emitting face of the sensor.

Advantages:

- Reflections from specular or transparent objects are suppressed

Disadvantages:

- The sensing range is reduced compared to standard sensors without polarisation filter

Special versions with autocollimation

Advantages:

- Transmit and receive channel use the same light source, i.e. no dead zone with reflectors in short distance range

Diffuse-reflection sensor

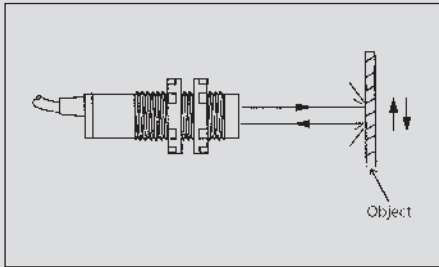

The light transmitter and receiver in a diffuse-reflection sensor are accommodated in one common enclosure. The light emitted from the transmitter is reflected diffused from the detected object. A part of this diffused reflection returns to the receiver and changes the switching status at the output when a certain intensity is exceeded. Accordingly, the texture and the colour of the object surface has a considerable influence on the object detection characteristics (presence – absence).

The sensing ranges specified in the Technical Data section of this catalogue are defined in accordance with DIN EN 60947-5-2: Sensing ranges up to 400 mm refer to a 100 x 100 mm white Kodak paper test card. 200 x 200 mm test cards are used for sensing ranges \geq 400 mm.

The reflectivity of the object surface to be sensed affects the sensing distance so that a correction or remission factor has to be specified. This value may vary from less than 10 % for matt-black plastic to 200 % for raw sheet aluminium (special values on request).

An application-dependent test of the specific object is usually recommended to take ambient conditions such as dust and humidity into consideration for the selection of the optimum sensor.

Advantages:

- Easy installation
- No reflector necessary

Disadvantages:

- Different sensing distances and sensitivity settings are required for different objects (surface, colour)

Diffuse-reflection sensor with background suppression

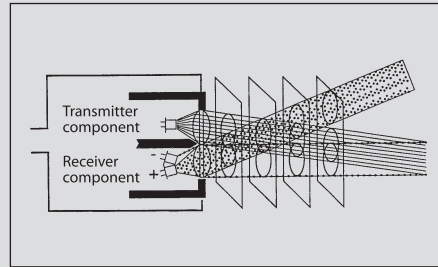

This is a special type of diffuse-reflection sensor. It is based on two receive modules or segmented receivers. Using the triangulation principle, reflections of objects beyond the target do not reach the active face of the receiver modules.

Advantages:

- No background effect on object detection (e.g. a faintly reflecting object may be detected in front of a high-gloss background)

Disadvantages:

- Short sensing distance
- Considerable technical expenditure

Convergent beam sensors, fixed focus

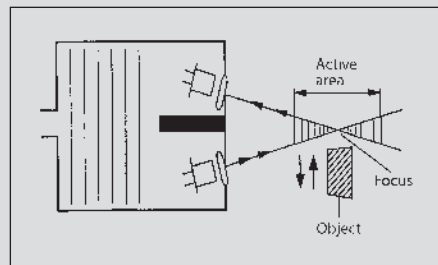

Convergent beam sensors, fixed focus
The transmit and receive modules of convergent beam sensors are arranged at a defined angle to each other. The light cone of the transmitter and receiver are joined at a fixed focal point. This results in the active zone for the detection of objects being defined around this focal point.

Advantages:

- Foreground / background suppression
- Defined active zone

Disadvantages:

- Short sensing distances (due to limited base width of sensor enclosure)

Angular optical system

The M18 series is available with a radial optical system (light outlet offset by 90°) for confined installation conditions. Compared to versions with an axial optical system, the sensing range of these sensors is slightly reduced due to optical displacement loss.

Reflectors

BERNSTEIN triple reflectors that consist of several triple mirrors arranged in a pyramid configuration are best suited for reflecting light in light barrier systems. The pyramid-like structure of these triple mirrors allows the reflector to be pivoted by up to 30° from the optical axis (e.g. caused by vibration or slight movement).

The specified sensing ranges of the retro-reflective sensors refer to the \varnothing 83 mm reflector (6572107003); the range is reduced accordingly with smaller reflectors.

Essentially, the size of the reflector should be selected according to the sensing range and the size of the object to be detected. The object should ideally be larger than the reflector so that it completely covers the reflector.

Optoelectronic Sensors (Type M12, M18)

Type	M12	M12	M12	M12
Operating mode	Diffuse-reflection sensor Type D	Diffuse-reflection sensor Type D	Diffuse-reflection sensor Type D	Through-beam sensor Type T
Sensing range	60 mm	60 mm	60 mm	6 m
Type of connection	Cable 2 m	Cable 2 m	Connector M12	Connector M12
Special feature				

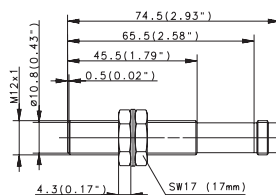
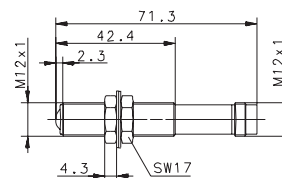
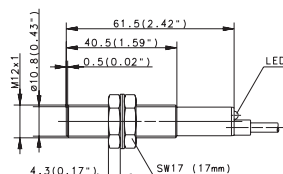
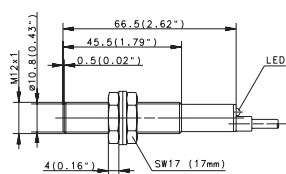

PNP	Light activated Type Dark activated Programmable Type	6557928002 OM12RT-DHTP-0060-CL	6557930002 OT12RT-DHTP-0060-CL	6557929002 OT12RT-DHTP-0060-S		
NPN	Light activated Dark activated Programmable					
Transmitter	Type				6551029001 OT12SE-DOOS-06.0-S	
Relay output						
NAMUR						
Analogue	Current output Voltage output					
2-wire	DC AC					

Technical data

Rated operating voltage	U_B	10–36 VDC	10–36 VDC	10–36 VDC	10–36 VDC
Rated operating current	I_B	50 mA	50 mA	50 mA	50 mA
Switching frequency (max)	F	> 100 Hz	> 100 Hz	> 100 Hz	> 100 Hz
Short circuit-protection		Cyclic	Cyclic	Cyclic	Cyclic
Function/operating voltage indicator		LED/-	LED/-	-/-	-/-
Sensitivity adjustable		-	-	-	-
Teachable					
Timer function					
Diagnostic function					
Type of light		IR 880 nm	IR 880 nm	IR 880 nm	IR 880 nm

Mechanical data

Ambient temperature (min/max)		-20°C/+70°C	-20°C/+70°C	-20°C/+70°C	-20°C/+70°C
Protection class in accordance with IEC 529, EN 60529		IP67	IP67	IP67	IP67
Enclosure material		CuZn39Pb3	PA	PA	PA, red
Connection		3 x 0.14 mm ²	3 x 0.14 mm ²	M12 x 1	M12 x 1

Please refer to Accessories for reflectors, mounting brackets, cable couplers and sensor tester.



M18		M18			
Diffuse-reflection sensor Type D	Diffuse-reflection sensor Type D	Diffuse-reflection sensor Type D	Diffuse-reflection sensor Type D		
40 mm	40 mm	100 mm	100 mm		
Cable 2 m	Connector M12	Cable 2 m	Connector M12		

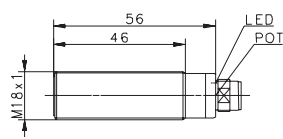
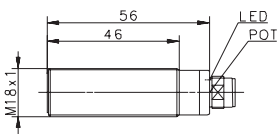
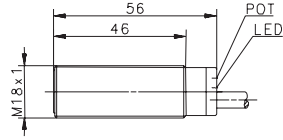
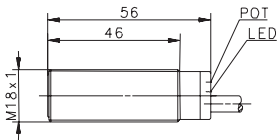

6558819001	6558818002	6557819004	6557818002				
OT18FF-DPTP-0040-CL	OT18FF-DPTP-0040-SL	OT18RT-DPTP-0100-CL	OT18RT-DPTP-0100-SL				

10–36 VDC	10–36 VDC	10–36 VDC	10–36 VDC		
50 mA	50 mA	200 mA	200 mA		
500 Hz	500 Hz	500 Hz	500 Hz		
Cyclic	Cyclic	Cyclic	Cyclic		
LED/-	LED/-	LED/-	LED/-		
-	-	-	-		
IR 880 nm	IR 880 nm	IR 880 nm	IR 880 nm		

-20°C/+70°C	-20°C/+70°C	-20°C/+70°C	-20°C/+70°C		
IP67	IP67	IP67	IP67		
PBT	PBT	PBT	PBT, black		
4 x 0.34 mm ²	M12 x 1	4 x 0.34 mm ²	M12 x 1		

You will find detailed data sheets to the products under www.bernstein.eu



Optoelectronic Sensors (Type M18)

Type	M18	M18	M18
Operating mode	Diffuse-reflection sensor Type D	Diffuse-reflection sensor Type D	Diffuse-reflection sensor Type D
Sensing range	200 mm	300 mm	300 mm
Type of connection	Cable 2 m	Connector M12	Connector M12
Special feature			Cable 2 m

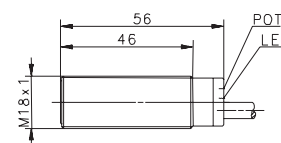
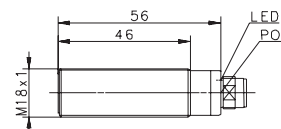
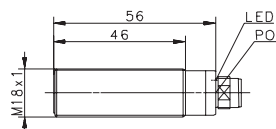
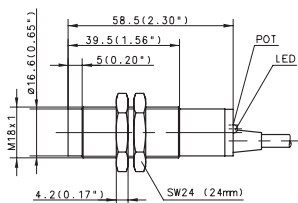

PNP	Light activated Dark activated Programmable Type	6557819001 OT18RT-DATP-0200-CEL	6557821002 ON18RT-DPTP-0300-SLE	6557816002 OM18RT-DPTP-0300-SLE	6557819005 OT18RT-DPTP-0300-CLE
NPN	Light activated Dark activated Programmable Type	6557219002 OT18RT-DATN-0200-CEL			
Transmitter	Type				
Relay output					
NAMUR					
Analogue	Current output Voltage output				
2-wire	DC AC				

Technical data					
Rated operating voltage	U_B	10–36 VDC	10–36 VDC	10–36 VDC	10–36 VDC
Rated operating current	I_B	200 mA	200 mA	200 mA	200 mA
Switching frequency (max)	F	> 250 Hz	500 Hz	500 Hz	500 Hz
Short circuit-protection		Cyclic	Cyclic	Cyclic	Cyclic
Function/operating voltage indicator		LED/-	LED/-	LED/-	LED/-
Sensitivity adjustable		Yes	Yes	Yes	Yes
Teachable					
Timer function					
Diagnostic function					
Type of light		IR 880 nm	IR 880 nm	IR 880 nm	IR 880 nm
Mechanical data					
Ambient temperature (min/max)		-20°C/+80°C	-20°C/+70°C	-20°C/+70°C	-20°C/+70°C
Protection class in accordance with IEC 529, EN 60529		IP65	IP67	IP67	IP67
Enclosure material		PA, red	Stainless steel 1.4305	CuZn39Pb3	PBT
Connection		4 x 0.25 mm ²	M12 x 1	M12 x 1	4 x 0.34 mm ²

Please refer to Accessories for reflectors, mounting brackets, cable couplers and sensor tester.



M18	M18		M18		M18	
Diffuse-reflection sensor Type D 300 mm Connector M12	Diffuse-reflection sensor Type D 500 mm Cable 2 m	Diffuse-reflection sensor Type D 500 mm Connector M12	Diffuse-reflection sensor Type D 500 mm Cable 2 m	Diffuse-reflection sensor Type D 500 mm Connector M12	Retro-reflective sensor Type R 2.5 m Cable 2 m Glass lens	Retro-reflective sensor Type R 2.5 m Connector M12 Glass lens

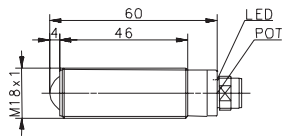
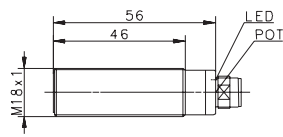
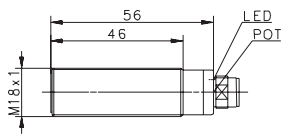
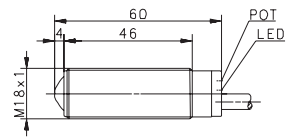
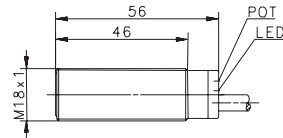
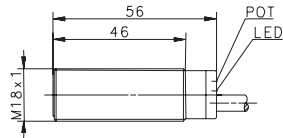
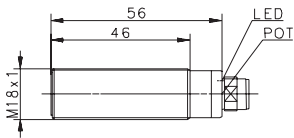

6557818003 OT18RT-DPTP-0300-SLE	6557817004 OM18RT-DPTP-0500-CLE	6557816006 OM18RT-DPTP-0500-SLE	6557819006 OT18RT-DPTP-0500-CLE	6557818006 OT18RT-DPTP-0500-SLE	6555819003 OT18PS-DPTP-02.5-CLE	6555818001 OT18PS-DPTP-02.5-SLE
6557218005 OT18RT-DPTN-0300-SLE	6557217003 OM18RT-DPTN-0500-CLE					

10–36 VDC	10–36 VDC	10–36 VDC	10–36 VDC	10–36 VDC	10–36 VDC	10–36 VDC
200 mA	200 mA	200 mA	200 mA	200 mA	200 mA	200 mA
500 Hz	500 Hz	500 Hz	500 Hz	500 Hz	500 Hz	500 Hz
Cyclic	Cyclic	Cyclic	Cyclic	Cyclic	Cyclic	Cyclic
LED/-	LED/-	LED/-	LED/-	LED/-	LED/-	LED/-
Yes	Yes	Yes	Yes	Yes	Yes	Yes
IR 880 nm	IR 880 nm	IR 880 nm	IR 880 nm	IR 880 nm	red 660 nm	red 660 nm

-20°C/+70°C	-20°C/+70°C	-20°C/+70°C	-20°C/+70°C	-20°C/+70°C	-20°C/+70°C	-20°C/+70°C
IP67	IP67	IP67	IP67	IP67	IP67	IP67
PBT	CuZn39Pb3	CuZn39Pb3	PBT	PBT	PBT, black	PBT, black
M12 x 1	4 x 0.34 mm ²	M12 x 1	4 x 0.34 mm ²	M12 x 1	4 x 0.34 mm ²	M12 x 1

You will find detailed data sheets to the products under www.bernstein.eu



Optoelectronic Sensors (Type M18, M30)

Type	M18	M18	M30	M30
Operating mode	Through-beam sensor Type T	Through-beam sensor Type T	Diffuse-reflection sensor Type D	Diffuse-reflection sensor Type D
Sensing range	8 m	8 m	200 mm	500 mm
Type of connection	Connector M12	Cable 2 m	Cable 6 m	Cable 2 m
Special feature				

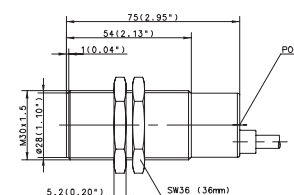
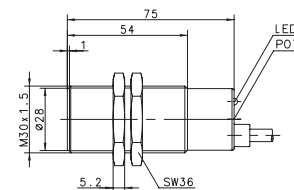
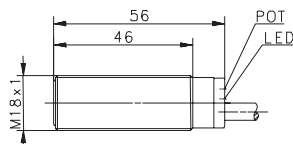
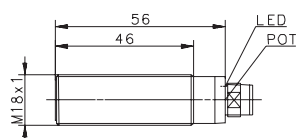

PNP	Light activated Type Dark activated Type Programmable Type				6557905008 OT30RT-DHTP-0200-6LE	6557005006 OT30RT-DDAP-0500-CE
NPN	Light activated Dark activated Programmable	6551821001 ON18EE-DPTP-08.0-SL	6551819001 OT18EE-DPTP-08.0-CL			
Transmitter	Type	6551021001 ON18SE-DOOS-08.0-SCV	6551019001 OT18SE-DOOS-08.0-CCV			
Relay output						
NAMUR						
Analogue	Current output Voltage output					
2-wire	DC AC					

Technical data

Rated operating voltage	U_B	10–36 VDC	10–36 VDC	10–36 VDC	10–30 VDC
Rated operating current	I_B	200 mA	200 mA	200 mA	–
Switching frequency (max)	F	500 Hz	500 Hz	> 250 Hz	–
Short circuit-protection		Cyclic	Cyclic	Yes	Yes
Function/operating voltage indicator		LED/–	LED/–	LED/–	–/–
Sensitivity adjustable		–	–	Yes	Yes
Teachable					
Timer function					
Diagnostic function					
Type of light		IR 880 nm	IR 880 nm	IR 880 nm	IR 880 nm

Mechanical data

Ambient temperature (min/max)		–20°C/+70°C	–20°C/+70°C	–20°C/+80°C	–20°C/+80°C
Protection class in accordance with IEC 529, EN 60529		IP67	IP67	IP65	IP65
Enclosure material		Stainless steel 1.4305	PBT, black	PA	PA
Connection		M12 x 1	4 x 0.34 mm ²	3 x 0.5 mm ²	3 x 0.5 mm ²

Please refer to Accessories for reflectors, mounting brackets, cable couplers and sensor tester.



Optoelectronic Sensors (Type 12 x 12 mm, 30 x 30 mm)

Type	12 x 12 x 55 mm		12 x 12 x 55 mm	12 x 12 x 60 mm
Operating mode	Through-beam sensor Type T	Through-beam sensor Type T	Through-beam sensor Type D	Diffuse-reflection sensor Type D
Sensing range	1 m	1 m	6 m	200 mm
Type of connection	Connector M8	Connector M8	Connector M8	Connector M8
Special feature	Core beam			

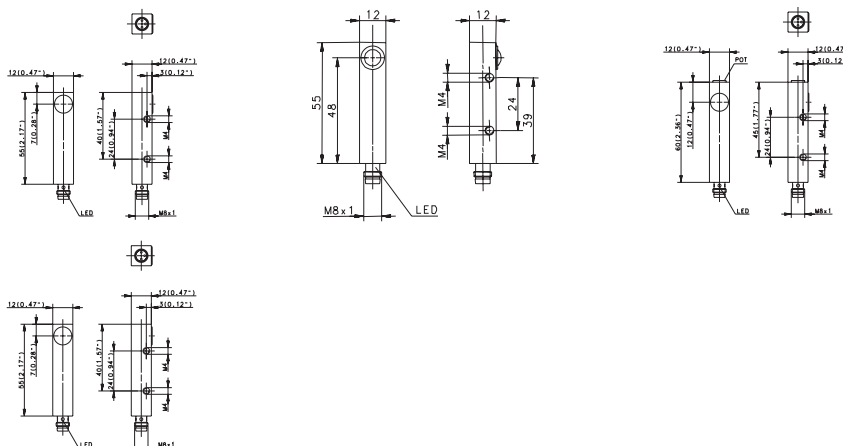

PNP	Light activated Type Dark activated Type Programmable Type	6551955002 OR12EE-DHTP-01.0-SL 6551755002 OR12EE-DDTP-01.0-SL	6551755004 OR12EE-DDTP-01.0-SLE	6551955001 OR12EE-DHTP-06.0-SL 6551755001 OR12EE-DDTP-06.0-SL	6557955001 OR12RT-DHTP-0200-SLE
NPN	Light activated Type Dark activated Programmable			6551355001 OR12EE-DHTN-06.0-SL	
Transmitter	Type	6551055003 OR12SE-DOOS-01.0-SVC		6551055002 OR12SE-DOOS-06.0-SVC	
Relay output					
NAMUR					
Analogue	Current output Voltage output				
2-wire	DC AC				

Technical data

Rated operating voltage	U_B	10–36 VDC	10–36 VDC	10–36 VDC	10–36 VDC
Rated operating current	I_B	200 mA	200 mA	200 mA	200 mA
Switching frequency (max)	F	100 Hz	100 Hz	100 Hz	100 Hz
Short circuit-protection		Cyclic	Cyclic	Cyclic	Cyclic
Function/operating voltage indicator		LED/-	LED/-	LED/-	LED/-
Sensitivity adjustable		-	Yes	-	Yes
Teachable					
Timer function					
Diagnostic function		Yes		Yes	
Type of light		IR 880 nm	IR 880 nm	IR 880 nm	IR 880 nm

Mechanical data

Ambient temperature (min/max)		-5°C/+70°C	-5°C/+70°C	-5°C/+70°C	-5°C/+70°C
Protection class in accordance with IEC 529, EN 60529		IP65	IP65	IP65	IP65
Enclosure material		CuZn39Pb3	CuZn39Pb3	CuZn39Pb3	CuZn39Pb3
Connection		M8 x 1	M8 x 1	M8 x 1	M8 x 1

Please refer to Accessories for reflectors, mounting brackets, cable couplers and sensor tester.



12 x 12 x 65 mm		12 x 12 x 65 mm		30 x 30 x 15 mm	
Diffuse-reflection sensor Type D	Diffuse-reflection sensor Type D	Retro-reflective sensor Type R	Retro-reflective sensor Type R	Diffuse-reflection sensor Type D	Diffuse-reflection sensor Type D
50 mm	1.2 m	4 m	4 m	1.2 m	1.2 m
Connector M8	Connector M8	Connector M8	Connector M8	Cable 3 m	Cable 3 m
Fixed focus/...				Antivalent ^②	

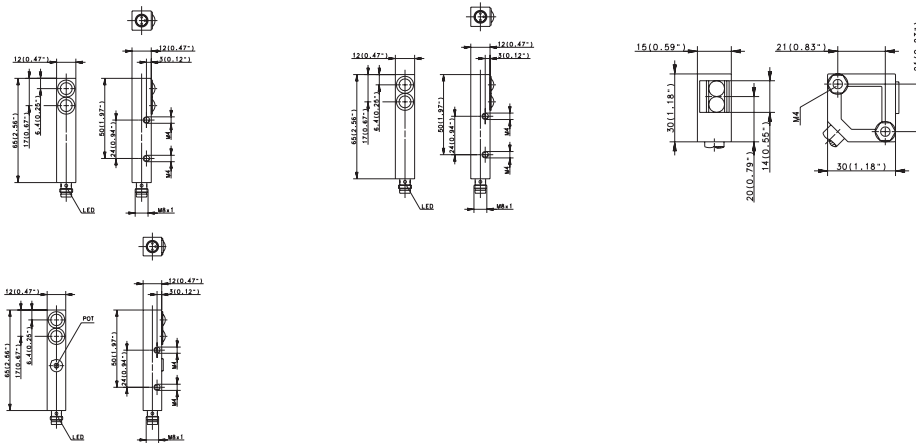

6558955001 OR12FF-DHTP-0050-SL	6557955002 OR12RT-DHTP-01.2-SLE	6554955001 OR12RS-DHTP-04.0-SL 6554755001 OR12RS-DDTP-04.0-SL		6557875003 ^② OR05RT-DATP-01.2-3DE			

10–36 VDC	10–36 VDC	10–36 VDC	10–36 VDC
200 mA	200 mA	200 mA	200 mA
100 Hz	100 Hz	100 Hz	< 1 kHz
Cyclic	Cyclic	Cyclic	Yes
LED/-	LED/-	LED/-	LED/LED
-	Yes	-	Yes
IR 880 nm	IR 880 nm	IR 880 nm	IR 880 nm

-5°C/+70°C	-5°C/+70°C	-5°C/+70°C	-25°C/+70°C
IP65	IP65	IP65	IP67
CuZn39Pb3	CuZn39Pb3	CuZn39Pb3	PBTB
M8 x 1	M8 x 1	M8 x 1	4 x 0.14 mm ²

You will find detailed data sheets to the products under www.bernstein.eu

^② Antivalent output



Optoelectronic Sensors (Type 30 x 30 mm, 40 x 26 mm)

Type	30 x 30 x 15 mm	30 x 30 x 15 mm	30 x 30 x 15 mm
Operating mode	Diffuse-reflection sensor Type D	Retro-reflective sensor Type R	Retro-reflective sensor Type R
Sensing range	1.2 m	4 m	4 m
Type of connection	Connector M8/Ø8	Cable 2 m	Cable 3 m
Special feature		polarised	polarised

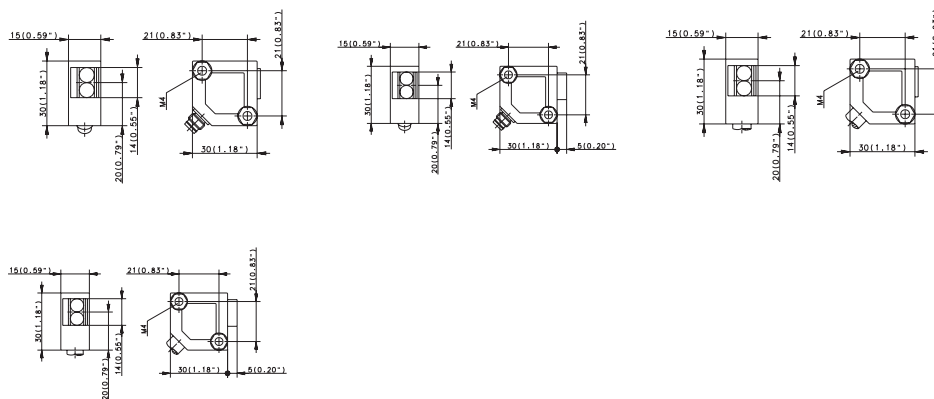

PNP	Light activated Type Dark activated Programmable Type	6557975003 OR05RT-DHTP-01.2-SLFE	6555975002 OR05PS-DHTP-04.0-3LFE				
NPN	Light activated Dark activated Programmable			6555875001 ^② OR05PS-DATP-04.0-3DE		6551875003 ^② OR05EE-DATP-12.0-3DE	
Transmitter	Type					6551075003 OR05SE-DOOS-12.0-3C	
Relay output							
NAMUR							
Analogue	Current output Voltage output						
2-wire	DC AC						

Technical data

Rated operating voltage	U_B	10–36 VDC	10–36 VDC	10–36 VDC	10–36 VDC
Rated operating current	I_B	200 mA	200 mA	200 mA	–
Switching frequency (max)	F	< 1000 Hz	< 1 kHz	< 1 kHz	–
Short circuit-protection		Yes	Yes	Yes	–
Function/operating voltage indicator		LED/LED	LED/LED	LED/LED	LED/LED
Sensitivity adjustable		Yes	Yes	Yes	Yes
Teachable					
Timer function					
Diagnostic function					
Type of light		IR 880 nm	red 660 nm	red 660 nm	IR 880 nm

Mechanical data

Ambient temperature (min/max)		–25°C/+70°C	–25°C/+70°C	–25°C/+70°C	–25°C/+70°C
Protection class in accordance with IEC 529, EN 60529		IP67	IP67	IP67	IP67
Enclosure material		PBTB	PBTB	PBTB	PBTB
Connection		4-pin	4 x 0.14 mm ²	4 x 0.14 mm ²	4 x 0.14 mm ²

Please refer to Accessories for reflectors, mounting brackets, cable couplers and sensor tester.

② Antivalent output

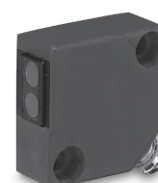

Optoelectronic Sensors (Type 88 x 63 mm)

Type	88 x 63 x 24 mm	88 x 63 x 24 mm		88 x 63 x 24 mm
Operating mode	Diffuse-reflection sensor Type D	Diffuse-reflection sensor Type D	Diffuse-reflection sensor Type D	Diffuse-reflection sensor Type D
Sensing range	400 mm	600 mm	1.5 m	1.5 m
Type of connection	Connect. space	Connect. space	Connect. space	Connect. space
Special feature	①			

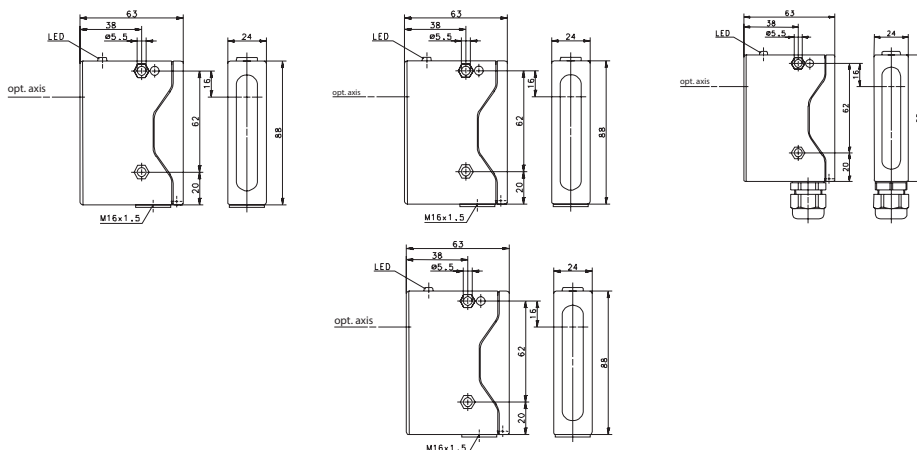

PNP	Light activated Type Dark activated Programmable Type		6557886003 OR20RT-DPTP-01.5-ALET	
NPN	Light activated Dark activated Programmable			
Transmitter				
Relay output	Type	6558686002 OR20RH-MAR5-0400-ALET	6557686001 OR20RT-MAR5-0600-ALET	6557686004 OR20RT-MAR5-01.5-ALET
NAMUR				
Analogue	Current output Voltage output			
2-wire	DC AC			

Technical data		12–265V AC/DC	12–265V AC/DC	10–36 VDC	12–265V AC/DC
Rated operating voltage	U_B	3 A	3 A	200 mA	3 A
Rated operating current	I_B	> 50 Hz	> 50 Hz	> 100 Hz	> 50 Hz
Switching frequency (max)	F	SCPD external	SCPD external	Cyclic	SCPD external
Short circuit-protection		LED/-	LED/-	LED/-	LED/-
Function/operating voltage indicator		Yes	Yes	Yes	Yes
Sensitivity adjustable		Yes	Yes	Yes	Yes
Teachable		Yes	Yes	Yes	Yes
Timer function		IR 880 nm	IR 880 nm	IR 880 nm	IR 880 nm
Diagnostic function					
Type of light					
Mechanical data					
Ambient temperature (min/max)		-20°C/+70°C	-20°C/+70°C	-20°C/+70°C	-20°C/+70°C
Protection class in accordance with IEC 529, EN 60529		IP65	IP65	IP65	IP65
Enclosure material		PA	PA, red	PA	PA, red
Connection		Connect. space	Connect. space	Connect. space	Connect. space

Please refer to Accessories for reflectors, mounting brackets, cable couplers and sensor tester.

① Background suppression



88 x 63 x 24 mm			
Retro-reflective sensor Type R	Retro-reflective sensor Type R		
6 m	6 m		
Connect. space polarised	Connect. space polarised		

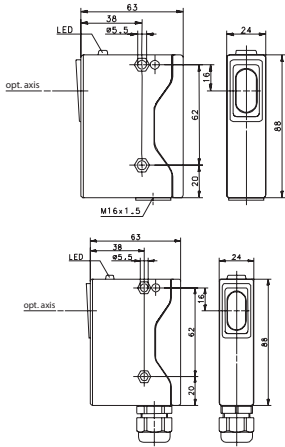

6555886001 OR20PS-DPTP-06.0-ALET						
	6555686002 OR20PS-MAR5-06.0-ALET					

10-36 VDC	12-265V AC/DC		
200 mA	3 A		
> 100 Hz	> 50 Hz		
Cyclic	SCPD external		
LED/-	LED/-		
Yes	Yes		
IR 880 nm	IR 880 nm		

-20°C/+70°C	-20°C/+70°C		
IP65	IP65		
PA, red	PA, red		
Connect. space	Connect. space		

You will find detailed data sheets to the products under www.bernstein.eu



Optoelectronic Sensors (Type 88 x 63 mm, Ø 20 mm)

Type	88 x 63 x 24 mm	88 x 63 x 24 mm		Ø 20 mm
Operating mode	Retro-reflective sensor Type R	Through-beam sensor Type T	Through-beam sensor Type T	Diffuse-reflection sensor Type D
Sensing range	8 m	20 m	20 m	200 mm
Type of connection	Connect. space	Connect. space	Connect. space	Connector M12
Special feature				

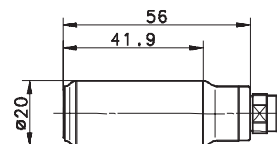
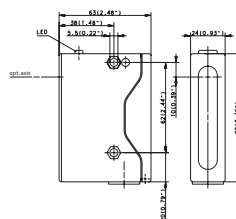
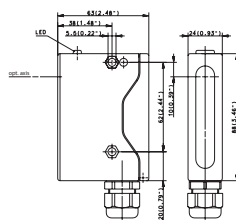
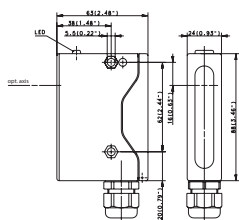

PNP	Light activated Dark activated Programmable Type		6551886003 OR20EE-DPTP-20.0-ALET		
NPN	Light activated Dark activated Programmable Type				
Transmitter	Type		6551086003 OR20SE-DOOS-20.0-AV	6551086002 OR20SE-MOOS-20.0-AV	
Relay output	Type	6554686002 OR20RS-MARS-08.0-ALET		6551686004 OR20EE-MARS-20.0-ALET	
NAMUR					
Analogue	Current output Voltage output Type				6557000001 OZ20RT-DPAP-0200-SE
2-wire	DC AC				

Technical data

Rated operating voltage	U_B	12–265V AC/DC	10–36VDC	12–265V AC/DC	10–30VDC
Rated operating current	I_B	3 A	200 mA	–	200 mA
Switching frequency (max)	F	> 50 Hz	> 100 Hz	–	–
Short circuit-protection		SCPD external	Cyclic	SCPD external	–
Function/operating voltage indicator		LED/–	LED/–	–/LED	–/–
Sensitivity adjustable		Yes	Yes	–	Yes
Teachable					
Timer function		Yes	Yes	Yes	
Diagnostic function					
Type of light		IR 880 nm	IR 880 nm	IR 880 nm	IR 880 nm

Mechanical data

Ambient temperature (min/max)		–20°C/+70°C	–20°C/+70°C	–20°C/+70°C	–5°C/+70°C
Protection class in accordance with IEC 529, EN 60529		IP65	IP65	IP65	IP67
Enclosure material		PA, red	PA, red	PA, red	Stainless steel 1.4305
Connection		Connect. space	Connect. space	Connect. space	M12 x 1

Please refer to Accessories for reflectors, mounting brackets, cable couplers and sensor tester.



Magnetic Switches

General Information on BERNSTEIN Magnetic Switches

Electromechanical and electronic variants

BERNSTEIN has extended its range of electromechanical magnetic switches with electronic versions which operate according to the Hall and magnetoresistive principle.

Electromechanical and electronic magnetic switches have special properties which ensure optimum use in their respective environments.

The electronic versions are characterised by their enhanced mechanical properties (extremely high resistance to vibration, shock or impact) and are not prone to wear in operation.

Thanks to the use of only one single "active" component (reed contact), "traditional" electromechanical magnetic switches are extremely reliable in operation. The universal current capability and low procurement costs allow these switches to be used in a wide range of applications.

The matrix below highlights the main features of each functional principle and helps you to decide on which magnetic switch to use for your application.



Technical features and applications

More detailed information on the technical features and applications relating to the different functional principles are provided in the following sections.

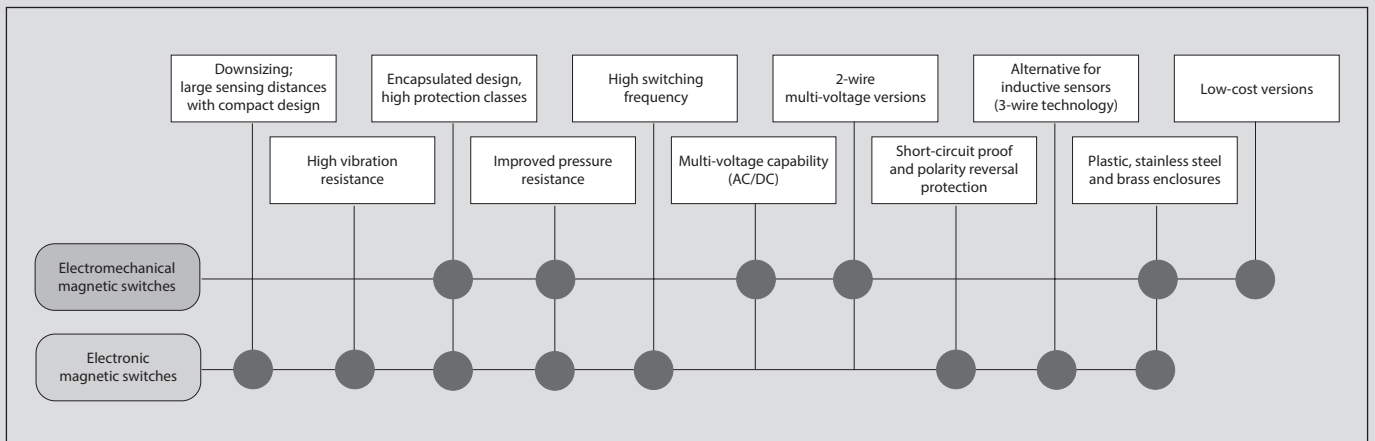

Electromechanical Magnetic Switches

Special features of electromechanical magnetic switches

- Reliable under extreme ambient conditions such as dirt, humidity, gas, dust, etc.
- Protection class up to IP 67
- Stable switching point, reproducible switching point accuracy of approx. 0.1 mm
- Can be operated from several directions
- Can be mounted in any position
- High operational reliability ensured by the use of only one single component
- Easy to install
- Long electrical service life (depending on the load to be switched) more than 10^8 switching cycles if contacts are suitably protected
- Special versions available for extreme temperatures from $-40\text{ }^{\circ}\text{C}$ to $+150\text{ }^{\circ}\text{C}$
- Can be connected to direct and alternating voltage sources

Design, function and operating principle of an electromechanical magnetic switch

The basic elements of this type of switch are the components which change their electrical characteristics in response to the approach of an actuating magnet. The contact paddles assume opposing polarity (north and south pole) under the influence of a magnetic field.

The approach can be made by either permanent magnets or electromagnets; the sensitivity of the switch and the field strength of the magnet determine the distance between the switch and magnet. Opening and closing of the contact studs is determined by the magnet correspondingly approaching or moving away from the switch. Normally-closed, normally-open and changeover contacts as well as bistable versions are included in our range of products.

The magnetically influenced parts and their auxiliary components (resistor, diode, triac, output stage, etc.) are cast in high quality insulating material or casting compound to increase the vibration / impact strength and guarantee a protection class up to IP 67. Metal versions (stainless steel, aluminium and brass) as well as standard plastic versions are available for use under extreme ambient conditions such as wider temperature ranges.

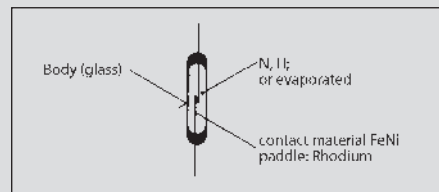

Design of a reed contact

Biasing (bistable)

Bias magnets energise or hold the contact closed. The contact of the bistable normally-open or normally-closed contact is held closed until a stronger magnet with opposite polarity neutralises the biasing.

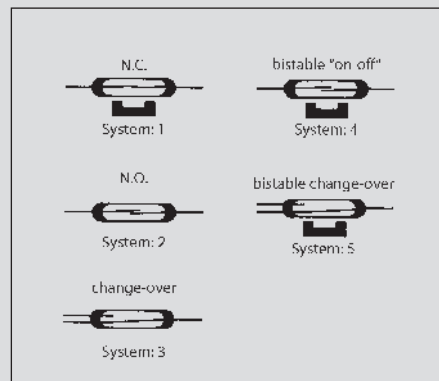

Types of reed contact switches

Actuation and switching characteristics

The switching characteristics are principally determined by the approach and polarity of the magnet. The following drawings show typical characteristics. Materials and external dimensions are specified in the product overview. Magnetic switches with reed contact output are identified by an "A" in the second position of the type code (MA...).

Switching frequency

Up to 200 Hz, depending on the size of load to be switched (considerably faster than relays, contactors etc.).

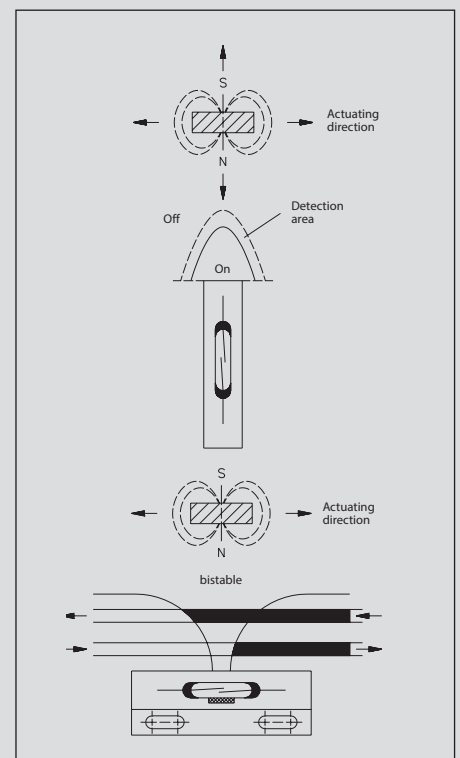
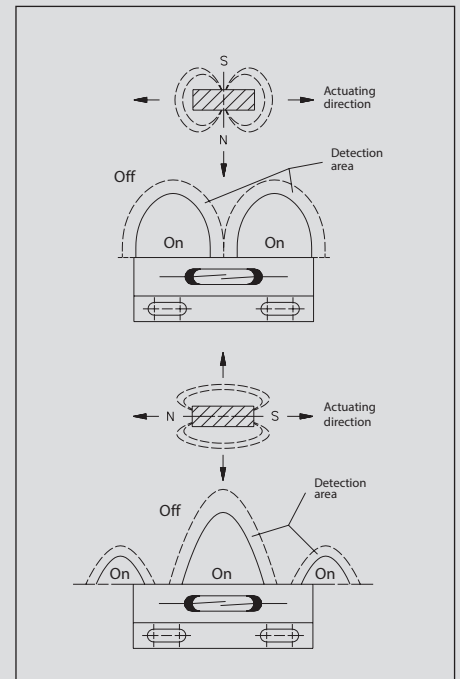

Magnetic Switches

Switching distances

Refer to the tables in this catalogue to identify which switching magnets may be used as well as the minimum achievable switching distance.

Temperature ranges

The standard version may be used in a temperature range from $-5\text{ }^{\circ}\text{C}$ to $+70\text{ }^{\circ}\text{C}$. Special types are also available offering an extended operating temperature range from $-40\text{ }^{\circ}\text{C}$ to $+150\text{ }^{\circ}\text{C}$.

Electrical service life

To maintain a long service life of the electrical contacts, it is important to ensure the maximum supply voltage and maximum switching current are not exceeded. Refer to the diagrams on Page 67 for the load values.

Guidelines for reed contact protection

The values for current, voltage and power specified in the catalogue apply only to purely resistive loads. Very often, however, these loads are exposed to inductive or capacitive components. In these cases it is advisable to protect the reed contacts against voltage and current peaks. Whilst it is not possible to recommend a safe contact protection concept that applies to all load ranges (each individual case will require its own evaluation), we would like to present general guidelines on how reed contacts may be connected to different loads in order to avoid premature failure.

1. Inductive loads

In DC applications, contact protection is relatively easy to realise with the aid of a free-wheeling diode connected in parallel to the load. The diode polarity must be selected so that it blocks when normal operating voltage is applied but will short-circuit the voltage induced after the switch is opened (voltage peaks can significantly exceed the operating voltage).

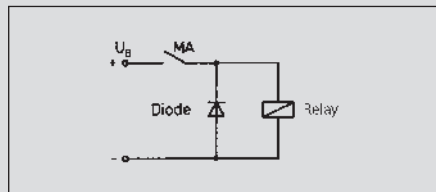

Suppression of voltage peaks with a free-wheeling diode

1) Voltage peaks induced by switching off inductive loads are suppressed by connecting a voltage-dependent resistor (VDR) in parallel to the reed contact.

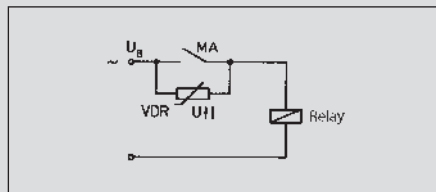

Suppression of voltage peaks with a VDR

2) In AC voltage applications effective protection is achieved with a combination of a resistor and a capacitor (RC element).

Generally, the RC element is connected parallel to the contact and therefore in series to the load (vice versa is also possible).

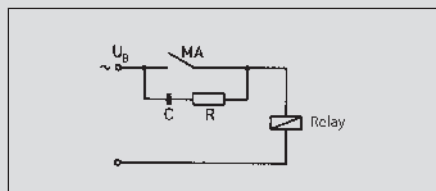

Suppression of voltage peaks with RC element

2. Capacitive loads

In contrast to inductive loads, an increase of making currents can occur in connection with capacitive loads and lamp loads that could damage and even weld contacts closed. When capacitors are switched (e.g. cable capacitance) a very high peak current occurs with its intensity depending on the capacitance and length of the cable leading to the switch.

A resistor connected in series to the contact will reduce this current. The size of the resistor is determined by the characteristics of the corresponding electric circuit.

It should, however, be as large as possible to reduce the current to a permissible value, thus ensuring reliable contact protection.

Contact protection with resistors for limiting current:

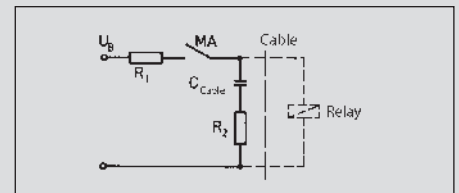

Capacitive load

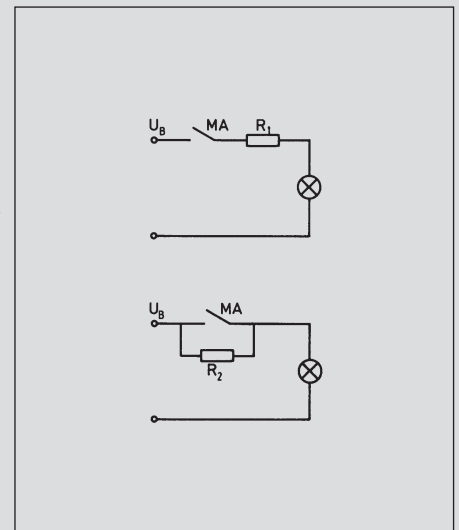

Lamp load

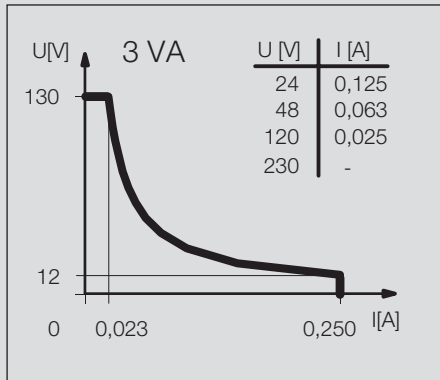
Performance diagrams for electromechanical magnetic switches

(1)

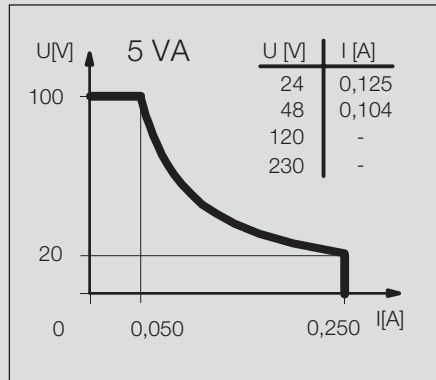

(2)

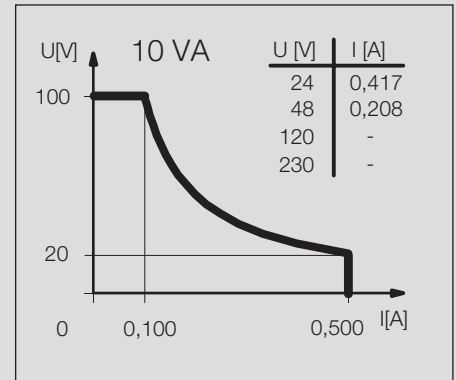

(3)

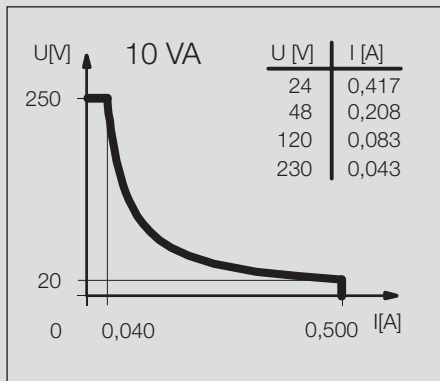

(4)

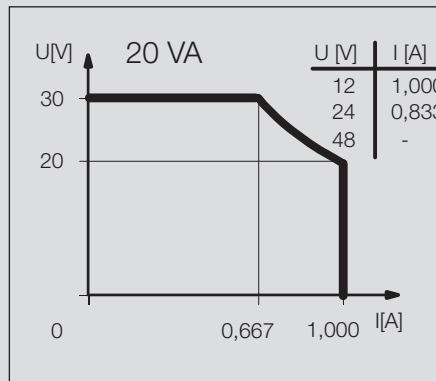

(5)

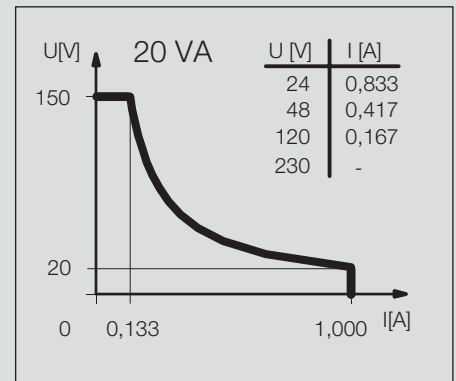

(6)

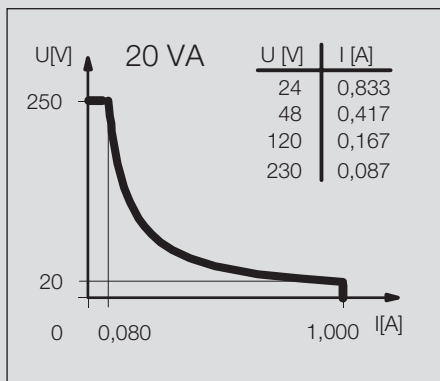

(7)

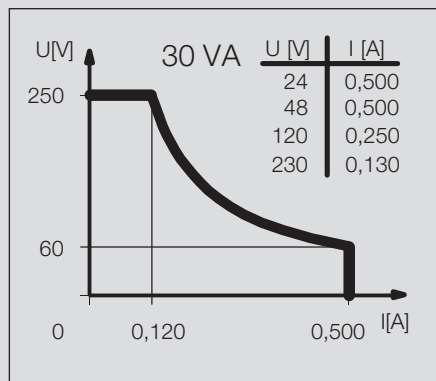

(8)

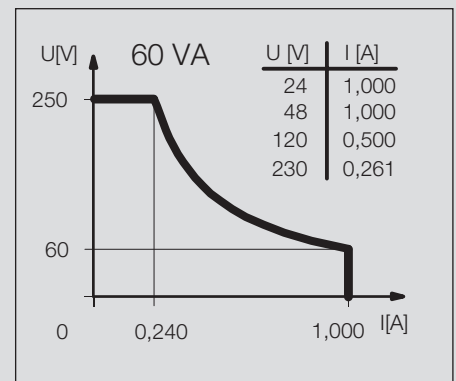

(9)

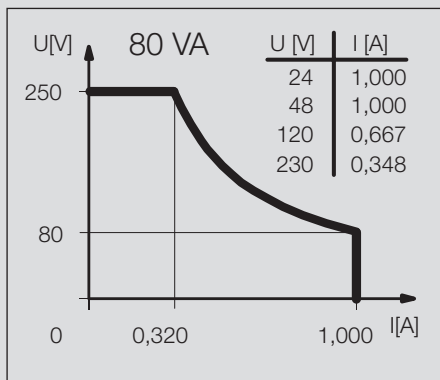

(10)

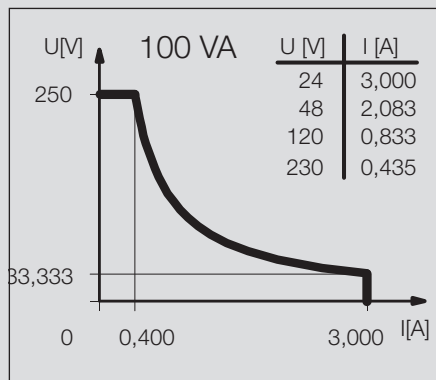

(11)

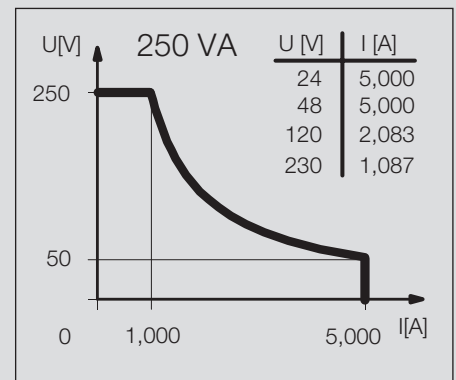

(12)

Magnetic Switches (Type Ø 6 mm, Ø 6.5 mm, Ø 12 mm, Ø 13 mm)

Type	Ø 6 mm		Ø 6.5 mm		Ø 12 mm	
Nominal switching distance (San)	19 mm	19 mm	18 mm		6 mm	7 mm
Type of connection	Cable 1 m	Cable 1 m	Cable 2 m		Cable 1 m	Cable 1 m
Reference magnet (Page)	T-62 N/S	T-62 N/S	T-62 N/S		T-62 N/S	T-62 N/S
Special feature						

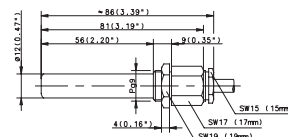
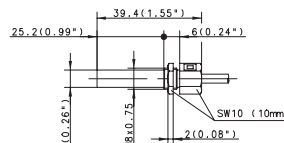
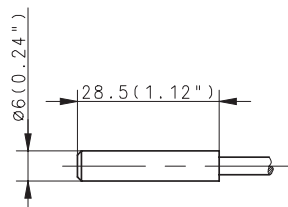

Switching function	NO contact	6311230571	6310246500		6314206246
	Type	MAK-3012-B-1	MAK-4612-A-2		MAA-0612-F-1
NC contact	Type				
	Changeover contact	6310330572		6317306315	
Type	MAK-3013-X-1			MAA-0613-M-1	
	Bistable				
Type					

Technical data	Ø 6 mm		Ø 6.5 mm		Ø 12 mm	
Max. switching voltage	100 V	250 V	250 V		250 V	250 V
Switching current (max)	0.25 A	0.5 A	0.5 A		1 A	3 A
Performance class (diagram No.)	5 VA	10 VA	20 VA		80 VA	100 VA
Shock resistance		50 g (11 ms)				

Mechanical data	Ø 6 mm		Ø 6.5 mm		Ø 12 mm	
Ambient temperature (min/max)	-5°C/+70°C	-5°C/+70°C	-5°C/+70°C		-5°C/+70°C	-5°C/+70°C
Protection class in accordance with IEC 529, EN 60529	IP67	IP67	IP67		IP67	IP67
Enclosure material	PA	PA	PA		Aluminium	Al/CuZn39Pb3
Connection	3 x 0.14 mm ²	2 x 0.14 mm	2 x 0.14 mm ²		4 x 0.75 mm ²	3 x 0.75 mm ²

Please refer to Accessories for magnets, mounting brackets, cable couplers and sensor tester.

Type	Ø 12 mm		Ø 12 mm		Ø 12 mm	
Nominal switching distance (San)	7 mm	7 mm	7 mm	7 mm	8 mm	12 mm
Type of connection	Cable 1 m	Cable 3 m	Cable 8 m	Cable 2 m	Cable 1 m	Cable 1 m
Reference magnet (Page)	T-62 N/S	T-62 N/S	T-62 N/S	T-62 N/S	T-62 N/S	T-62 N/S
Special feature			Temperature			

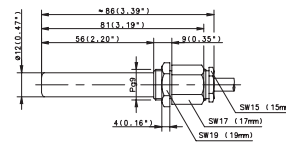
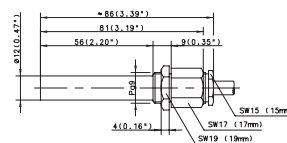
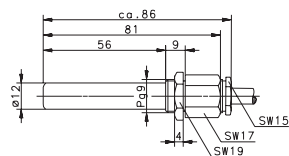

Switching function	NO contact	6312206321	6314216476	6314216585	6314226423	
	Type	MAA-0612-D-1	MAN-1612-F-3	MAN-1612-FT-8	MAK-2612-F-1	
NC contact	Type					
	Changeover contact					6315306314
Type	MAA-0613-K-1					6316316259
	Bistable					MAN-1613-L-1

Technical data	Ø 12 mm		Ø 12 mm		Ø 12 mm	
Max. switching voltage	250 V	250 V	250 V	250 V	250 V	250 V
Switching current (max)	0.5 A	3 A	3 A	3 A	0.5 A	1 A
Performance class (diagram No.)	30 VA	100 VA	100 VA	100 VA	30 VA	60 VA
Shock resistance		50 g (11 ms)				

Mechanical data	Ø 12 mm		Ø 12 mm		Ø 12 mm	
Ambient temperature (min/max)	-5°C/+70°C	-5°C/+70°C	-40°C/+150°C	-5°C/+70°C	-5°C/+70°C	-5°C/+70°C
Protection class in accordance with IEC 529, EN 60529	IP67	IP67	IP67	IP67	IP67	IP67
Enclosure material	Aluminium	Stainless steel 1.4305	Stainless steel 1.4305	PA, red	Al/CuZn39Pb3	Stainless steel 1.4305
Connection	3 x 0.75 mm ²	3 x 0.75 mm ²	3 x 0.75 mm ²	2 x 0.5 mm ²	4 x 0.75 mm ²	4 x 0.75 mm ²

Please refer to Accessories for magnets, mounting brackets, cable couplers and sensor tester.

Ø 12 mm		Ø 12 mm		Ø 12 mm		Ø 13 mm	
12 mm	12 mm	16 mm	18 mm	19 mm	19 mm	9 mm	20 mm
Cable 1 m	Cable 1 m	Cable 4 m	Cable 1m	Cable 1 m	Cable 1 m	Cable 1 m	Cable 1 m
T-62 N/S	T-62 N/S	T-62 N/S	T-62 N/S	T-69 N/S	T-69 N/S	T-62 N/S	T-62 N/S
		Temperature			Temperature		

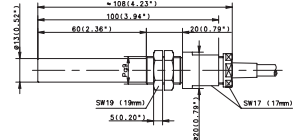
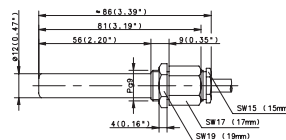
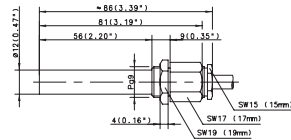
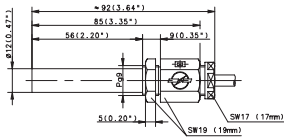

6316326426 MAK-2613-L-1	6315326425 MAK-2613-K-1	6410206399 MAA-0612-NT-4	6310406554 MAA-0614-P-1	6316306248 MAA-0613-L-1	6316306004 MAA-0613-LT-1	6310136616 MAK-3611-P-1	6310536617 MAK-3615-L-1
-----------------------------------	-----------------------------------	------------------------------------	-----------------------------------	-----------------------------------	------------------------------------	-----------------------------------	-----------------------------------

250 V	250 V	250 V	250 V	250 V	250 V	250 V	250 V
1 A	0.5 A	1.5 A	5 A	1 A	1 A	5 A	1 A
60 VA	30 VA	50 VA	250 VA	60 VA	60 VA	250 VA	60 VA

-5°C/+70°C	-5°C/+70°C	-40°C/+150°C	-5°C/+70°C	-5°C/+70°C	-40°C/+150°C	-5°C/+70°C	-5°C/+70°C
IP67	IP67	IP67	IP67	IP67	IP67	IP67	IP67
PA, red	PA, red	Al/CuZn39Pb3	Al/CuZn39Pb3	Al/CuZn39Pb3	Al/CuZn39Pb3	PA, black	PA, black
3 x 0.5 mm ²	3 x 0.5 mm ²	3 x 0.75 mm ²	3 x 0.75 mm ²	4 x 0.75 mm ²	4 x 0.75 mm ²	2 x 0.75 mm ²	3 x 0.75 mm ²

You will find detailed data sheets to the products under www.bernstein.eu



Magnetic Switches (Type Ø 15.5 mm, M8, M12, PG9, 28.6 x 18 mm)

Type	Ø 15.5 mm	M8	M8	M8
Nominal switching distance (San)	6 mm	13 mm	13 mm	18 mm
Type of connection	Connector	Cable 1 m	Connector	Cable 1 m
Reference magnet (Page)	T-62 N/S	T-62 N/S	T-62 N/S	T-62 N/S
Special feature				

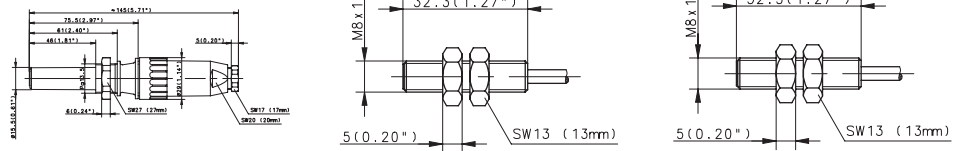

Switching function	NO contact				6311208596
	Type				MAN-0812-B-1
	NC contact				
	Type				
	Changeover contact				
Type					
Type					
Bistable					
Type					

Technical data	Ø 15.5 mm	M8	M8	M8
Max. switching voltage	250 V	100 V	30 V	250 V
Switching current (max)	1 A	0.5 A	1 A	0.5 A
Performance class (diagram No.)	80 VA	10 VA	20 VA	10 VA
Shock resistance				

Mechanical data	Ø 15.5 mm	M8	M8	M8
Ambient temperature (min/max)	-5°C/+70°C	-20°C/+70°C	-5°C/+70°C	-5°C/+70°C
Protection class in accordance with IEC 529, EN 60529	IP65	IP67	IP65	IP67
Enclosure material	PC, grey	Stainless steel 1.4305	Stainless steel 1.4305	Stainless steel 1.4305
Connection	Amphenol	3 x 0.14 mm ²	Ø 6.5 mm	2 x 0.14 mm ²

Please refer to Accessories for magnets, mounting brackets, cable couplers and sensor tester.

Type	M12	M12	M12	M12
Nominal switching distance (San)	7 mm	7 mm	10 mm	12 mm
Type of connection	Cable 1 m	Cable 2 m	Cable 1 m	Cable 1 m
Reference magnet (Page)	T-62 N/S	T-62 N/S	T-62 N/S	T-62 N/S
Special feature				

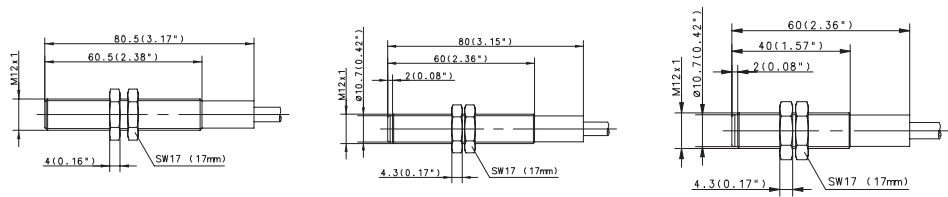

Switching function	NO contact	6314223268	6314233002		6416228260	6311218294
	Type	MAM-2312-F-1	MAK-3312-F-2		MAK-2812-L-3	MAM-1812-B-1
	NC contact					
	Changeover contact					
	Type			6316333005	6316318002	
Type			MAK-3313-L-1	MAM-1813-L-1		
Bistable						

Technical data	M12	M12	M12	M12	M12
Max. switching voltage	250 V	250 V	250 V	250 V	250 V
Switching current (max)	3 A	3 A	1 A	1 A	1 A
Performance class (diagram No.)	100 VA	100 VA	60 VA	60 VA	60 VA
Shock resistance		50 g (11 ms)			50 g (11 ms)

Mechanical data	M12	M12	M12	M12	M12
Ambient temperature (min/max)	-5°C/+70°C	-25°C/+70°C	-5°C/+70°C	-5°C/+70°C	-5°C/+70°C
Protection class in accordance with IEC 529, EN 60529	IP67	IP67	IP67	IP67	IP67
Enclosure material	CuZn39Pb3	PA, red	PA, red	CuZn39Pb3	PA, red
Connection	2 x 0.5 mm ²	2 x 0.5 mm ²	3 x 0.5 mm ²	3 x 0.5 mm ²	2 x 0.5 mm ²

Please refer to Accessories for magnets, mounting brackets, cable couplers and sensor tester.

M12		PG9		PG9		28.6x18x6.4mm	
18 mm	22 mm	17 mm	20 mm	20 mm	8 mm	8 mm	
Cable 2 m	Cable 2 m	Cable 2 m	Cable 2 m	Cable 2 m	Cable 1 m	Cable 1.5 m	
T-62 N/S	T-62 N/S	T-62 N/S	T-62 N/S	D	TK-11-11	TK-11-11	

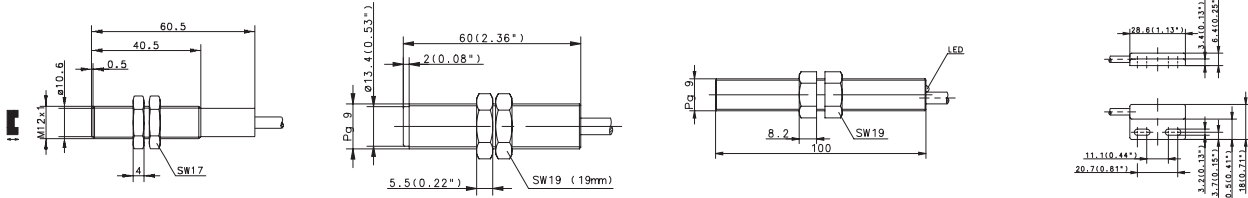

6310118626 MAM-1811-2	6410433350 MAK-3314-P-2	6316343544 MAM-4313-L-2	6310431569 MAM-3114-2-LED	6310311615 MAK-1113-1	6410311368 MAK-1113-1,5
---------------------------------	-----------------------------------	-----------------------------------	-------------------------------------	---------------------------------	-----------------------------------

175 V	250 V	250 V	250 V	130 V	130 V
0.25 A	1.5 A	1 A	1 A	0.25 A	0.25 A
5 VA	250 VA	60 VA	120 VA	3 VA	3 VA
50 g (11 ms)					

-5°C/+70°C	-25°C/+70°C	-5°C/+80°C	-5°C/+80°C	-5°C/+70°C	-20°C/+70°C
IP67	IP67	IP65	IP65	IP67	IP67
CuZn39Pb3	PA, red	CuZn39Pb3	CuZn39Pb3	PA, black	PA
2 x 0.34 mm ²	2 x 0.5 mm ²	3 x 0.5 mm ²	2 x 0.5 mm ²	3 x 0.14 mm ²	3 x 0.14 mm ²

You will find detailed data sheets to the products under www.bernstein.eu



Magnetic Switches (Type 28.6 x 18, 45 x 13, 45 x 25.5, 68 x 30, 80 x 20)

Type	28.6x18x6.4mm		45x13x9mm		45x25.5x9mm	
Nominal switching distance (San)	10 mm	25 mm	10 mm		5 mm	10 mm
Type of connection	Cable 1 m	Cable 5 m	Cable 2 m		Cable 1 m	Cable 1 m
Reference magnet (Page)	TK-11-11	T-67 N/S	TK-11-01		TK-45	TK-45
Special feature						

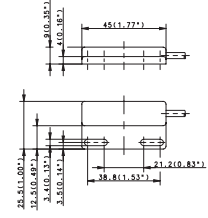
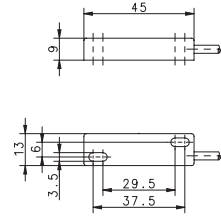
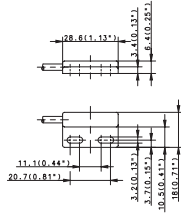

Switching function	NO contact	6311211541	6311201095	6311245539
	Type	MAK-1112-B-1	MAK-0112-B-2	MAK-4512-B-1
	NC contact			
	Type			
	Changeover contact			
Type		6311411603		6316345540
Bistable		MAK-1114-B-5		MAK-4513-L-1
Type				

Technical data	28.6x18x6.4mm		45x13x9mm		45x25.5x9mm	
Max. switching voltage	250 V	250 V	250 V		250 V	250 V
Switching current (max)	0.5 A	0.5 A	0.5 A		1 A	0.5 A
Performance class (diagram No.)	10 VA	10 VA	10 VA		60 VA	10 VA
Shock resistance						50 g (11 ms)

Mechanical data	28.6x18x6.4mm		45x13x9mm		45x25.5x9mm	
Ambient temperature (min/max)	-5°C/+70°C		-5°C/+70°C		-5°C/+70°C	
Protection class in accordance with IEC 529, EN 60529	IP67		IP67		IP67	
Enclosure material	PA, black		PA, black		PA	
Connection	2 x 0.14 mm		2 x 0.14 mm		2 x 0.34 mm ²	

Please refer to Accessories for magnets, mounting brackets, cable couplers and sensor tester.

Type	68x30x15mm		80x20x15mm		80x20x15mm	
Nominal switching distance (San)	8 mm		18 mm	18 mm	20 mm	10 mm
Type of connection	Cable 1 m		Cable 1 m	Cable 1 m	Cable 3 m	Cable 3 m
Reference magnet (Page)	T-62 N/S		TK-21-02	TK-21-02	T-62 N/S	T-67
Special feature					Temperature	

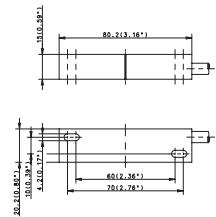
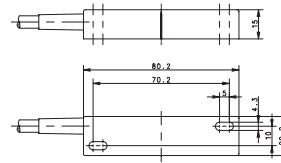
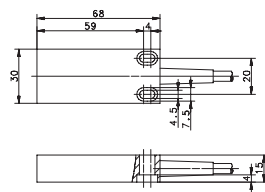

Switching function	NO contact	6316313004	6315302309	6315312196	6314402566	6419402397
	Type	MAK-1313-L-1	MAK-0213-K-1	MAK-1213-K-1	MAA-0214-FT-3	MAK-0214-P-3
	NC contact					
	Changeover contact					
	Type					
Bistable						

Technical data	68x30x15mm		80x20x15mm		80x20x15mm	
Max. switching voltage	250 V		250 V	250 V	250 V	250 V
Switching current (max)	1 A		0.5 A	0.5 A	3 A	5 A
Performance class (diagram No.)	60 VA		30 VA	30 VA	100 VA	250 VA
Shock resistance						10 g (11 ms)

Mechanical data	68x30x15mm		80x20x15mm		80x20x15mm	
Ambient temperature (min/max)	-5°C/+70°C		-5°C/+70°C	-5°C/+70°C	-40°C/+150°C	-25°C/+70°C
Protection class in accordance with IEC 529, EN 60529	IP67		IP67	IP67	IP67	IP67
Enclosure material	PC, red		PA, black	PA, red	GDAISI12, red	PA, black
Connection	3 x 0.5 mm ²		3 x 0.75 mm ²	3 x 0.75 mm ²	3 x 0.75 mm ²	2 x 0.5 mm ²

Please refer to Accessories for magnets, mounting brackets, cable couplers and sensor tester.

80x20x15 mm		80x20x15 mm		80x20x15 mm	
21 mm	21 mm	21 mm	24 mm	24 mm	25 mm
Cable 1 m	Cable 1 m	Cable 1 m	Cable 1 m	Cable 1 m	Cable 1 m
TK-21-02	TK-21-02	TK-21-12	TA-21-02	TK-21-12	T-62 N/S

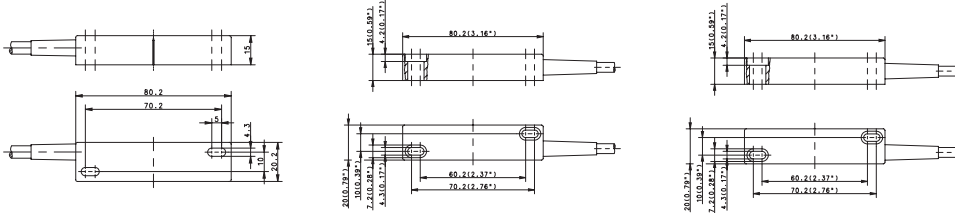

6312202316 MAK-0212-L-1	6314202204 MAK-0212-F-1	6314212217 MAK-1212-F-1	6316302206 MAK-0213-L-1	6316312220 MAK-1213-L-1	6410412143 MAK-1214-L-2
-----------------------------------	-----------------------------------	-----------------------------------	-----------------------------------	-----------------------------------	-----------------------------------

250 V	250 V	250 V	250 V	250 V	250 V
0.5 A	3 A	3 A	1 A	1 A	1 A
30 VA	100 VA	100 VA	60 VA	60 VA	60 VA

-5°C/+70°C	-5°C/+70°C	-5°C/+70°C	-5°C/+70°C	-5°C/+70°C	-5°C/+70°C
IP67	IP67	IP67	IP67	IP67	IP67
PA, black	PA, black	PA, red	PA, black	PA, red	PA, red
2 x 0.75 mm ²	2 x 0.75 mm ²	2 x 0.5 mm ²	3 x 0.5 mm ²	3 x 0.5 mm ²	2 x 0.5 mm ²

You will find detailed data sheets to the products under www.bernstein.eu



Magnetic Switches (Type 80 x 20 mm, 80 x 30 mm, 85 x 24 mm, 88 x 25 mm, 100 x 58 mm)

Type	80x20x15 mm		80x30x15 mm		80x30x15 mm	
Nominal switching distance (San)	25 mm	30 mm	8 mm	19 mm	20 mm	22 mm
Type of connection	Connector M8	Cable 1 m	Cable 1 m	Cable 1 m	Cable 1 m	Cable 1 m
Reference magnet (Page)	Ø 10 x 50 Neod	TA-21-02	TK-44	TK-44	T-62 N/S	TK-44
Special feature		Temperature				

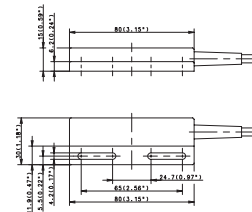
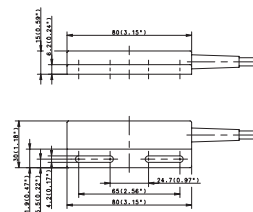
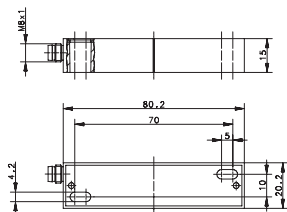

Switching function	80x20x15 mm		80x30x15 mm		80x30x15 mm	
	NO contact Type	6310302636	6316302389	6314144542	6314244536	6317344538
NC contact Type	MAA-0213-STK	MAA-0213-LT-1	MAK-4411-F-1	MAK-4412-F-1	MAK-4413-M-1	MAK-4413-M-1
Changeover contact Type						
Bistable Type						
Bistable Type						

Technical data	80x20x15 mm		80x30x15 mm		80x30x15 mm	
Max. switching voltage	60 V	250 V	250 V	250 V	250 V	250 V
Switching current (max)	1 A	1 A	3 A	3 A	5 A	1 A
Performance class (diagram No.)	3 VA	60 VA	100 VA	100 VA	250 VA	80 VA
Shock resistance		10 g (11 ms)				

Mechanical data	80x20x15 mm		80x30x15 mm		80x30x15 mm	
Ambient temperature (min/max)	-30°C/+80°C	-40°C/+150°C	-5°C/+70°C	-5°C/+70°C	-5°C/+70°C	-5°C/+70°C
Protection class in accordance with IEC 529, EN 60529	IP65	IP67	IP67	IP67	IP67	IP67
Enclosure material	GDAISi 12, red	GDAISi12, red	PA, black	PA, black	PA, black	PA
Connection	M8 x 1	4 x 0.75 mm ²	2 x 0.5 mm ²	2 x 0.5 mm ²	2 x 0.5 mm ²	3 x 0.5 mm ²

Please refer to Accessories for magnets, mounting brackets, cable couplers and sensor tester.

Type	85x24x26 mm		85x24x26 mm		88x25x13 mm	
Nominal switching distance (San)	15 mm	24 mm	24 mm		22 mm	25 mm
Type of connection	Cable 3 m	Cable 1 m	Flat plug		Cable 1 m	Cable 1 m
Reference magnet (Page)	T-67 N/S	T-69 N/S	T-69 N/S		TK-42	TK-42
Special feature			K4.8			

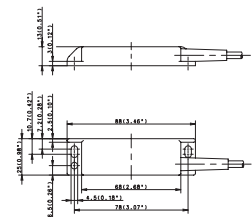
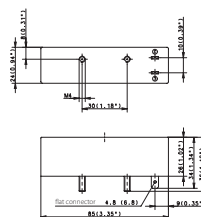
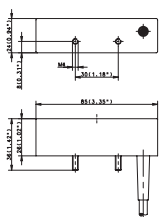

Switching function	85x24x26 mm		85x24x26 mm		88x25x13 mm	
	NO contact Type	6314432609	6310432598	6310432590		6314242533
NC contact Type	MAK-3214-F-3	MAK-3214-P-1	MAK-3214-P-STK4.8		MAK-4212-F-1	MAK-4212-F-1
Changeover contact Type						
Bistable Type						
Bistable Type						

Technical data	85x24x26 mm		85x24x26 mm		88x25x13 mm	
Max. switching voltage	250 V	250 V	250 V		250 V	250 V
Switching current (max)	3 A	5 A	5 A		1 A	3 A
Performance class (diagram No.)	100 VA	250 VA	250 VA		80 VA	100 VA
Shock resistance						

Mechanical data	85x24x26 mm		85x24x26 mm		88x25x13 mm	
Ambient temperature (min/max)	-25°C/+70°C	-5°C/+70°C	-20°C/+70°C		-5°C/+70°C	-5°C/+70°C
Protection class in accordance with IEC 529, EN 60529	IP67	IP67	IP67		IP67	IP67
Enclosure material	PBT	PA, black	PBT, black		PA, black	PA, black
Connection	2 x 0.5 mm ²	2 x 0.75 mm ²	4.8 mm		3 x 0.5 mm ²	2 x 0.5 mm ²

Please refer to Accessories for magnets, mounting brackets, cable couplers and sensor tester.

88x25x13 mm		100x58x29.5		100x58x29.5	
25 mm	25 mm	10 mm	10 mm	15 mm	
Cable 1 m	Cable 3 m	Screw terminal	Screw terminal	Screw terminal	
T-69 N/S	T-69 N/S	TA-31	TA-31	T-62 N/S	

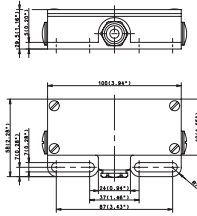
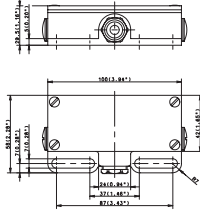
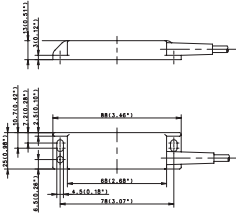

			6314203232 MAA-0312-F		
6310442534 MAK-4214-P-1	6310442622 MAK-4214-P-3	6317303312 MAA-0313-M		6319403532 MAA-0314-P	

250 V	250 V	250 V	250 V	250 V
5 A	5 A	1 A	3 A	5 A
250 VA	250 VA	80 VA	100 VA	250 VA

-5°C/+70°C	-5°C/+70°C	-5°C/+70°C	-25°C/+70°C	-25°C/+70°C
IP67	IP67	IP67	IP65	IP65
PA, black	PA, black	Aluminium	Aluminium	Aluminium
2 x 0.5 mm ²	2 x 0.5 mm ²	max. 1.5 mm ²	max. 1.5 mm ²	max. 1.5 mm ²

You will find detailed data sheets to the products under www.bernstein.eu



Electronic Magnetic Sensors

Thanks to their special properties, electronic magnetic switches with magnetoresistive or Hall elements are ideal for use in many different applications. They are used to detect position, angle and / or speed and are immune to shock, impact, vibration and wear. High switching frequencies, long switching distances, a broad temperature range and excellent reproducibility are other advantageous features of this technology which in many cases make them the technically superior alternative to electromechanical reed contacts.



The fact that many non-magnetic metals allow magnetic fields to pass unhindered also extends the fields of application for magnetic sensors. This makes it possible to encapsulate sensors in a sturdy pressure-proof metal enclosure. Sensors can, however, also be mounted in tubing or concealed behind non-magnetic metal surfaces.

Advantages of electronic magnetic sensors over electromechanical reed contacts

- Reliable and immune to vibration
- Bounce-free switching
- Unlimited service life
- High repeat accuracy
- Short response times
- High sensitivity
- Thermal stability

Select the sensor and the technical principle that best meet your requirements from the comprehensive BERNSTEIN range of magnetic sensors: Hall sensors with minimum circuitry, standard Hall sensors with integrated sensor electronics or magnetoresistive sensors. Round, square or metric bodies in plastic, brass, brass / plastic or stainless enclosures.

Fundamentals of Hall sensor technology

The BERNSTEIN range of magnetic sensors is based on a modular system comprising an encapsulated Hall element with the EMC protective circuitry. These sensors therefore conform to the requirements of EN-60947-5-2 for non-mechanical magnetic proximity switches. Sensors of various designs are available for a wide variety of applications.



- Output circuitry NPN, NO contact or bistable
- Voltage range 4.5 – 24 V DC
- Polarity reversal protected
- Switching frequencies up to 20 kHz
- Size ranging from 6 mm diameter to 50 x 25 x 10 mm
- Unipolar version

Standard range of Hall sensors

In contrast to the more basic BERNSTEIN Hall sensors, the functionality and modularity have been enhanced in these Hall sensors by integrating comprehensive sensor electronics. In this segment BERNSTEIN also offers a complete modular system that can be adapted to suit your specific needs.

- Output circuitry PNP, NC or NO contact or bistable
- Voltage range 10 – 39 V DC
- Output current 400 mA, short-circuit proof
- Polarity reversal protected
- Switching frequencies up to 10 kHz
- Size ranging from M10 diameter to 50 x 25 x 10 mm
- Unipolar version

Single-channel speed sensors with high frequency range

BERNSTEIN offers a high performance series of gearwheel sensors designed as electronic magnetic sensors with Hall elements that detect the rotation of near-engine ferromagnetic gearwheels with sensing distances of up to 2 mm. A specific feature of these single-channel speed sensors is their high switching frequency. Based on the BERNSTEIN modular range of magnetic sensors, switching frequencies of up to 20 kHz can be realised. Switching frequencies up to 10 kHz can be achieved in the standard range. The sensors are available in M12 and M18 versions. The characteristic versatility of Hall sensors is fully utilised in these applications:

Outstanding immunity to shock, impact, vibration, non-wearing and silent, high switching frequencies, broad temperature range, exceptional repeat accuracy.

Technical data

- Output circuitry PNP or NPN
- Voltage range 10 – 36 V DC
- Switching frequencies up to 20 kHz
- Sensing distance 0 – 2 mm on ferromagnetic material

Standard range of magnetoresistive sensors

Magnetoresistive sensors are more sensitive than Hall-effect sensors by a factor of 10. Not only can they be very small but they can also detect especially low field strengths.

In addition to their high measuring accuracy even at high ambient temperatures, these sensors are also characterised by a high degree of reliability and by the fact that they occupy little space. Since they are designed to be independent of polarity, the countermagnet does not need to be mounted with pole orientation. With corresponding encapsulation, BERNSTEIN magnetoresistive sensors have proven effective even in demanding environments such as lift construction or agricultural technology.

- Output circuitry PNP, NC or NO contact
- High sensitivity (up to sensing distance of 60 mm)
- Voltage range 10 – 39 V DC/10 – 30 V DC
- Output current 400 mA/200 mA, short-circuit proof
- Polarity reversal protected
- Polarity independent
- Size 6 mm diameter to M18

Microsensors

Ever more complex and above all more compact measuring and control configurations require components that occupy even less space. In line with this trend, BERNSTEIN has expanded its comprehensive range of sensors for determining position, angle and / or speed in industrial applications in two branches of development: Compared to the previous smallest model (RD = 6 mm), the diameter in this series of magnetoresistive sensors has been further reduced by 30 % yet the smallest model RD = 4 mm or 5 x 5 mm still achieves the parameters of the larger sensors. As part of the second development stage, the basic and standard range of electronic magnetic sensors has been expanded to include the latch functionality (bistable switching characteristic) which utilises the magnetic field only for the corresponding switching operation. As a result, this functionality has been added to a wide range of enclosure variants in the current modular range.

Sensing distances of electronic magnetic sensors

Since the sensing distances of magnetic sensors are influenced by the combination of sensor and magnet, it is appropriate to consider them as a complete system. The overview below shows the expected sensing distances (Sn) when using different magnets from the BERNSTEIN range.

Magnet	Size	Article number	Sn of Hall sensors	Sn of magneto-resistive sensors
T 75	Ø 5 mm	6301175057	5 mm	10 mm
T 06	Ø 6 mm	6301106065	5 mm	15 mm
T 61	Ø 20 mm	6301261035	10 mm	35 mm
T 62	Ø 23 mm	6301262039	17 mm	45 mm
T 67	Ø 20 mm	6301167054	15 mm	40 mm
T 69	Ø 31 mm	6301269031	20 mm	60 mm

Electronic Magnetic Sensors (Type D04, D06, M05, M08, M10, M12)

Type	D04	D06		M05
Operating mode	MR	Hall	MR	MR
Magnetic sensitivity (mT)	3 mT	10 mT	2 mT	3 mT
Sensing distance (Sn)	30 mm	17 mm	45 mm	30 mm
Reference magnet (Page)	T-62 N/S	T-62 N/S	T-62 N/S	T-62 N/S
Type of connection	Cable 2 m	Cable 2 m	Cable 2 m	Cable 2 m
Special feature				

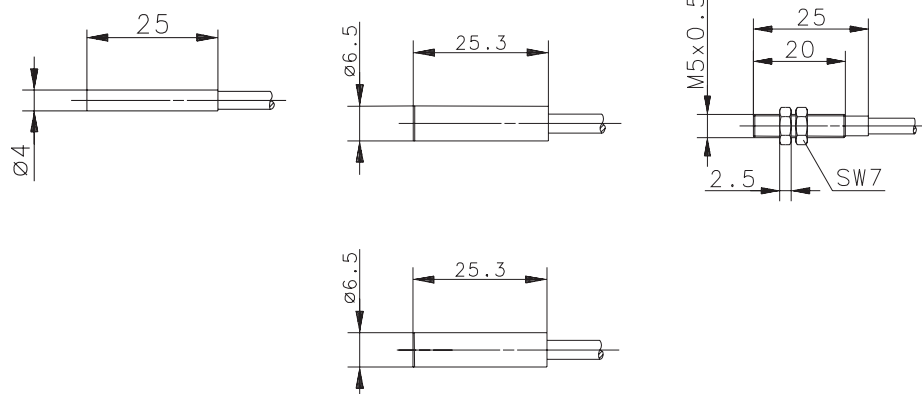

PNP	NO contact Type NC contact Type Bistable Type	6373299132 MEN-D04PS/M03-K2	6373270105 MEN-D06PS/M02-K2	6373299133 MEM-M05PS/M03-K2
NPN	NO contact Type NC contact Bistable Type		6362670001 MEN-D06NS/H10-K2 6363870032 MEN-D06NB/H11-K2	
Analogue	Current output Voltage output			

Technical data

Rated operating voltage	U_b	4.5–30 VDC	4.5–24 VDC	10–30 VDC	4.5–30 VDC
Rated operating current	I_b	200 mA	25 mA	200 mA	200 mA
Max. switching voltage	F	10 kHz	20 kHz	1500 Hz	10 kHz
Function/operating voltage indicator		–/–	–/–	–/–	–/–
Sensitivity adjustable					
Short circuit-protection		Current limiter	Current limiter	Cyclic	Current limiter
Teachable					

Mechanical data

Ambient temperature (min/max)	–20°C/+70°C	–25°C/+70°C	–25°C/+70°C	–20°C/+70°C
Protection class in accordance with IEC 529, EN 60529	IP67	IP67	IP67	IP67
Enclosure material	Stainless steel 1.4401	Stainless steel 1.4401	Stainless steel 1.4401	CuZn39Pb3
Connection	3 x 0.14 mm ²	3 x 0.14 mm ²	3 x 0.14 mm ²	3 x 0.14 mm ²

Please refer to Accessories for magnets, mounting brackets, cable couplers and sensor tester.



M08		M10		M10		M12	
Hall	MR	Hall	Hall	MR		Hall	Hall
10 mT	2 mT	10 mT	10 mT	1 mT		10 mT	10 mT
17 mm	45 mm	17 mm	17 mm	45 mm		17 mm	17 mm
T-62 N/S	T-62 N/S	T-62 N/S	T-62 N/S	T-62 N/S		T-62 N/S	T-62 N/S
Cable 2 m	Cable 2 m	Cable 2 m	Cable 2 m	Cable 2 m		Cable 2 m	Cable 2 m
			All-metal	All-metal			

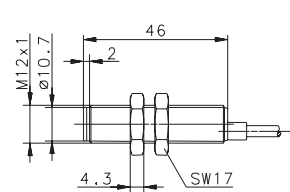
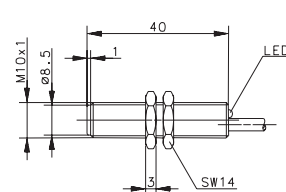
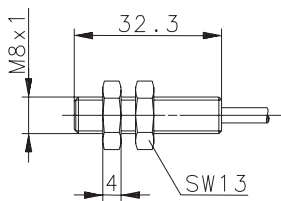
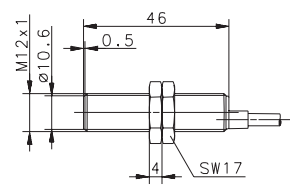
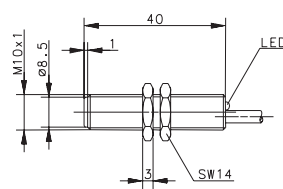
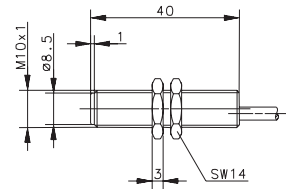
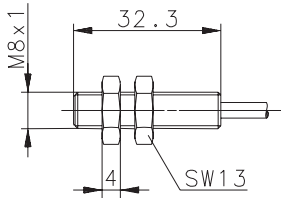

	6373260107 MEM-M08PS/M02-K2		6372261085 MEM-M10PS/H10-KL2 6372161086 MEM-M10PÖ/H10-KL2 6373461124 MEM-M10PB/H11-KL2	6373261087 MEM-M10PS/M01-KL2 6373161088 MEM-M10PÖ/M01-KL2			
6362660002 MEM-M08NS/H10-K2		6362661003 MEM-M10NS/H10-K2				6362662004 MEM-M12NS/H10-K2	6362662005 MEK-M12NS/H10-K2
6363860033 MEM-M08NB/H11-K2		6363861034 MEM-M10NB/H11-K2				6363862035 MEM-M12NB/H11-K2	6363862036 MEK-M12NB/H11-K2

4.5–24 V	10–30 V	4.5–24 V	10–39 V	10–39 V	4.5–24 V	4.5–24 V
25 mA	200 mA	25 mA	400 mA	400 mA	25 mA	25 mA
20 kHz	1500 Hz	20 kHz	10 kHz	10 kHz	20 kHz	20 kHz
-/-	-/-	-/-	LED/-	LED/-	-/-	-/-
Current limiter	Cyclic	Current limiter	Cyclic	Cyclic	Current limiter	Current limiter

-25°C/+70°C	-25°C/+70°C	-25°C/+70°C	-25°C/+70°C	-25°C/+70°C	-25°C/+70°C	-25°C/+70°C
IP67	IP67	IP67	IP67	IP67	IP67	IP67
CuZn39Pb3	CuZn39Pb3	CuZn39Pb3	CuZn39Pb3	CuZn39Pb3	CuZn39Pb3	PA
3 x 0.14 mm ²	3 x 0.14 mm ²	3 x 0.14 mm ²	3 x 0.14 mm ²	3 x 0.14 mm ²	3 x 0.14 mm ²	3 x 0.14 mm ²

You will find detailed data sheets to the products under www.bernstein.eu

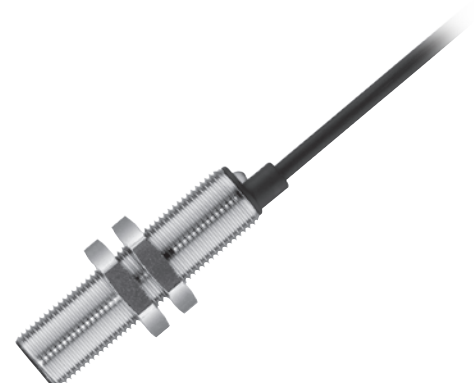

Electronic Magnetic Sensors (Type M12, M18)

Type	M12		M12		M12	
Operating mode	Hall	Hall	Hall	MR	MR	MR
Magnetic sensitivity (mT)	10 mT	10 mT	10 mT	1 mT	1 mT	1 mT
Sensing distance (S _n)	17 mm	17 mm	17 mm	45 mm	45 mm	45 mm
Reference magnet (Page)	T-62 N/S	T-62 N/S	T-62 N/S	T-62 N/S	T-62 N/S	T-62 N/S
Type of connection	Cable 2 m	Cable 10 m	Cable 2 m	Cable 2 m	Cable 5 m	Cable 2 m
Special feature						

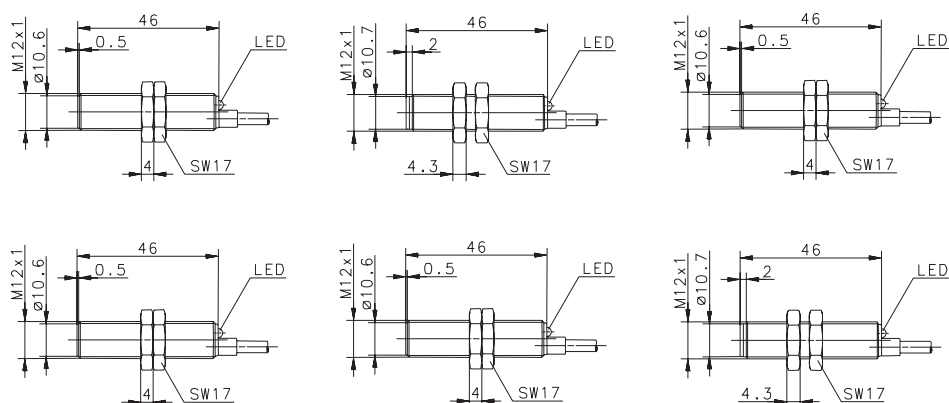

PNP	NO contact Type NC contact Type Bistable Type	6372262090 MEM-M12PS/H10-KL2 6372162092 MEM-M12PÖ/H10-KL2 6373462126 MEM-M12PB/H11-KL2	6472262077 MEM-M12PS/H10-KL10	6372262089 MEK-M12PS/H10-KL2 6372162091 MEK-M12PÖ/H10-KL2 6373462125 MEK-M12PB/H11-KL2	6373262094 MEM-M12PS/M01-KL2 6373162096 MEM-M12PÖ/M01-KL2	6373262123 MEM-M12PS/M01-KL5	6373262093 MEK-M12PS/M01-KL2 6373162095 MEK-M12PÖ/M01-KL2
NPN	NO contact Type NC contact Type Bistable Type						
Analogue	Current output Voltage output						

Technical data						
Rated operating voltage	U _B	10–39 VDC	10–39 VDC	10–39 VDC	10–39 VDC	10–39 VDC
Rated operating current	I _B	400 mA	400 mA	400 mA	400 mA	400 mA
Max. switching voltage	F	10 kHz	10 kHz	10 kHz	10 kHz	1500 Hz
Function/operating voltage indicator		LED/-	LED/-	LED/-	LED/-	LED/-
Sensitivity adjustable						
Short circuit-protection		Cyclic	Cyclic	Cyclic	Cyclic	Cyclic
Teachable						

Mechanical data						
Ambient temperature (min/max)		-25°C/+70°C	-25°C/+70°C	-25°C/+70°C	-25°C/+70°C	-25°C/+70°C
Protection class in accordance with IEC 529, EN 60529		IP67	IP67	IP67	IP67	IP67
Enclosure material		CuZn39Pb3	CuZn39Pb3	PA	CuZn39Pb3	PA
Connection		3 x 0.14 mm ²	3 x 0.14 mm ²	3 x 0.14 mm ²	3 x 0.14 mm ²	3 x 0.14 mm ²

Please refer to Accessories for magnets, mounting brackets, cable couplers and sensor tester.



M12		M12		M18		M18	
Hall	Hall	Hall	Hall	Hall	Hall	Hall	Hall
-	-	-	-	10 mT	10 mT	10 mT	10 mT
0-2 mm	0-2 mm	0-2 mm	0-2 mm	17 mm	17 mm	17 mm	17 mm
-	-	-	-	T-62 N/S	T-62 N/S	T-62 N/S	T-62 N/S
Cable 2 m	Cable 2 m	Cable 2 m	Cable 2 m	Cable 2 m	Cable 2 m	Cable 2 m	Cable 2 m
Speed	Speed	Speed	Speed				

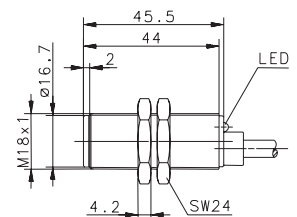
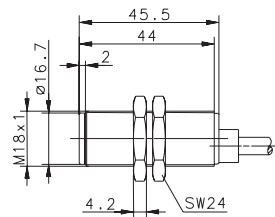
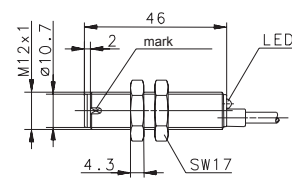
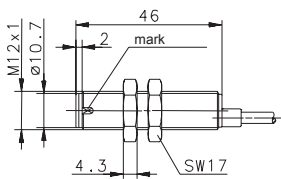
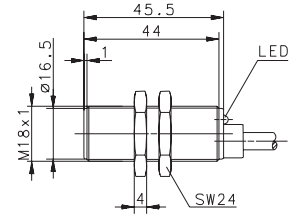
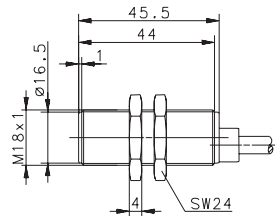
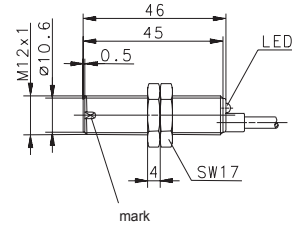
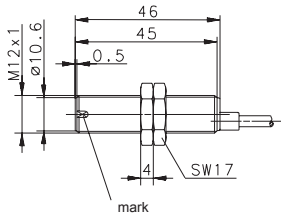

		6379262120 MEM-M12PD/H-KL2	6379262119 MEK-M12PD/H-KL2			6372263098 MEM-M18PS/H10-KL2	6372263097 MEK-M18PS/H10-KL2
						6372163100 MEM-M18PÖ/H10-KL2	6372163099 MEK-M18PÖ/H10-KL2
						6373463128 MEM-M18PB/H11-KL2	6373463127 MEK-M18PB/H11-KL2
6369662028 MEM-M12ND/H-K2	6369662027 MEK-M12ND/H-K2			6362663006 MEM-M18NS/H10-K2	6362663007 MEK-M18NS/H10-K2		
				6363863037 MEM-M18NB/H11-K2	6363863038 MEK-M18NB/H11-K2		

10-36 V	10-36 V	10-39 V	10-39 V	4.5-24 V	4.5-24 V	10-39 V	10-39 V
< 20 mA	< 20 mA	400 mA	400 mA	25 mA	25 mA	400 mA	400 mA
20 kHz	20 kHz	10 kHz	10 kHz	20 kHz	20 kHz	10 kHz	10 kHz
-/-	-/-	LED/-	LED/-	-/-	-/-	LED/-	LED/-
Cyclic	Cyclic	Cyclic	Cyclic	Current limiter	Current limiter	Cyclic	Cyclic

-25°C/+70°C	-25°C/+70°C	-25°C/+70°C	-25°C/+70°C	-25°C/+70°C	-25°C/+70°C	-25°C/+70°C	-25°C/+70°C
IP67	IP67	IP67	IP67	IP67	IP67	IP67	IP67
CuZn39Pb3	PA, red	CuZn39Pb3	PA, red	CuZn39Pb3	PBT	CuZn39Pb3	PBT
3 x 0.14 mm ²	3 x 0.14 mm ²	3 x 0.14 mm ²	3 x 0.14 mm ²	3 x 0.14 mm ²	3 x 0.14 mm ²	3 x 0.14 mm ²	3 x 0.14 mm ²

You will find detailed data sheets to the products under www.bernstein.eu

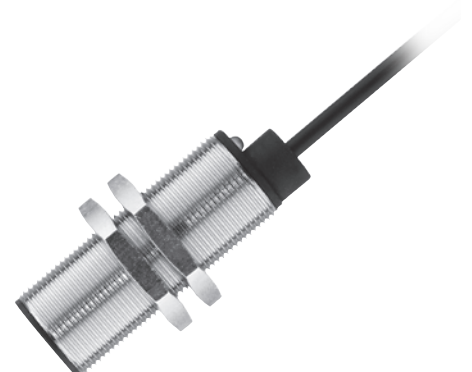

Electronic Magnetic Sensors (Type M18, Q05, Q08, Q12, E27, E29)

Type	M18		M18		Q05
Operating mode	MR	MR	Hall	Hall	MR
Magnetic sensitivity (mT)	1 mT	1 mT	-	-	3 mT
Sensing distance (S _n)	45 mm	45 mm	0 – 2 mm	0 – 2 mm	10 mm
Reference magnet (Page)	T-62 N/S	T-62 N/S	-	-	T-62 N/S
Type of connection	Cable 2 m	Cable 2 m	Cable 2 m	Cable 2 m	Cable 2 m
Special feature			Speed	Speed	

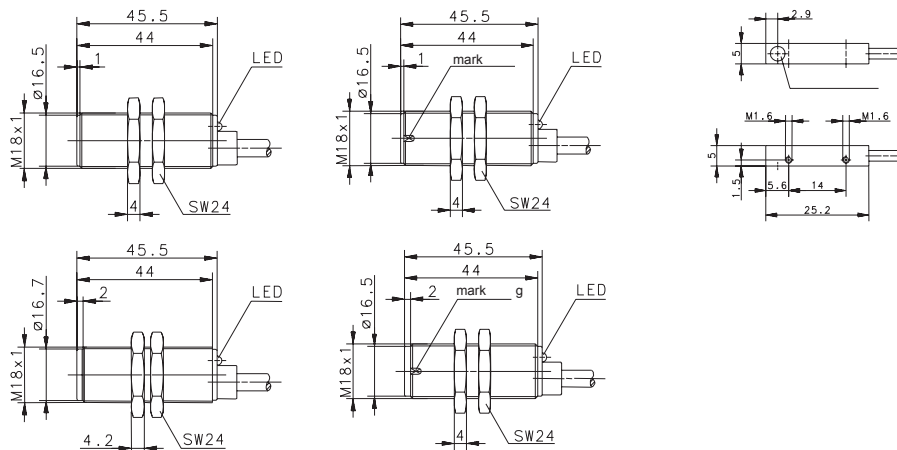

PNP	NPN	Analogue	6373263102	6373263101	6379263122	6379263121	6373299134
NO contact	NO contact	Current output	MEM-M18PS/M01-KL2	MEK-M18PS/M01-KL2	MEM-M18PD/H-KL2	MEK-M18PD/H-KL2	MEM-Q05PS/M03-K2
Type	Type	Voltage output	6373163104	6373163103			
NC contact	NC contact		MEM-M18PÖ/M01-KL2	MEK-M18PÖ/M01-KL2			
Type	Type						
Bistable	Bistable						
Type	Type						

Technical data	6373263102	6373263101	6379263122	6379263121	6373299134
Rated operating voltage U _B	10–39 VDC	10–39 VDC	10–39 VDC	10–39 VDC	4.5–30 VDC
Rated operating current I _B	400 mA	400 mA	400 mA	400 mA	200 mA
Max. switching voltage F	10 kHz	10 kHz	10 kHz	10 kHz	10 kHz
Function/operating voltage indicator	LED/-	LED/-	LED/-	LED/-	-/-
Sensitivity adjustable					
Short circuit-protection	Cyclic	Cyclic	Cyclic	Cyclic	Current limiter
Teachable					

Mechanical data	6373263102	6373263101	6379263122	6379263121	6373299134
Ambient temperature (min/max)	-25°C/+70°C	-25°C/+70°C	-25°C/+70°C	-25°C/+70°C	-20°C/+70°C
Protection class in accordance with IEC 529, EN 60529	IP67	IP67	IP67	IP67	IP67
Enclosure material	CuZn39Pb3	PBT	CuZn39Pb3	PBT, black	CuZn39Pb3
Connection	3 x 0.14 mm ²	3 x 0.14 mm ²	3 x 0.14 mm ²	3 x 0.14 mm ²	3 x 0.05 mm ²

Please refer to Accessories for magnets, mounting brackets, cable couplers and sensor tester.



Q08		Q12		E27		E29
Hall	MR	Hall	Hall	Hall	Hall	Hall
10 mT	2 mT	10 mT	10 mT	10 mT	2 mT	10 mT
17 mm	45 mm	17 mm	17 mm	17 mm	30 mm	17 mm
T-62 N/S	T-62 N/S	T-62 N/S	T-62 N/S	T-62 N/S	T-62 N/S	T-62 N/S
Cable 2 m	Cable 2 m	Cable 2 m	Cable 2 m	Cable 2 m	Cable 2 m	Cable 2 m

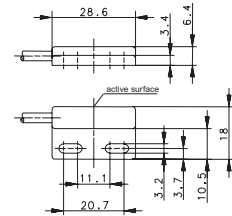
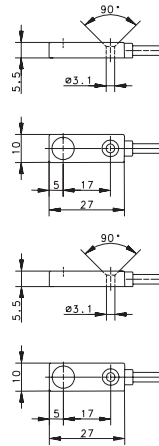
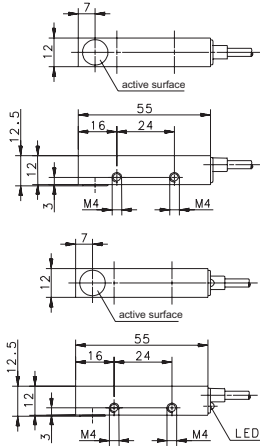
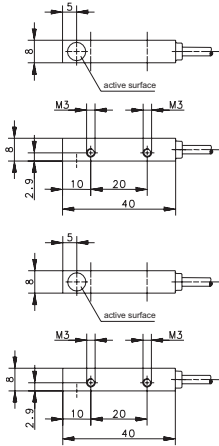

	6373280106 MEM-Q08PS/M02-K2		6372255083 MEM-Q12PS/H10-KL2 6372155084 MEM-Q12PO/H10-KL2 6373455131 MEM-Q12PB/H11-KL2			
6362680012 MEM-Q08NS/H10-K2		6362655013 MEM-Q12NS/H10-K2		6362693010 MEK-E27NS/H10-K2		6362611008 MEK-E29NS/H10-K2
6363880043 MEM-Q08NB/H11-K2		6363855044 MEM-Q12NB/H11-K2		6363893041 MEK-E27NB/H11-K2	6363893031 MEK-E27NB/H02-K2	6363811039 MEK-E29NB/H11-K2

4.5–24 VDC	10–30 VDC	4.5–24 VDC	10–39 VDC	4.5–24 VDC	4.5–24 VDC	4.5–24 VDC
25 mA	200 mA	25 mA	400 mA	25 mA	25 mA	25 mA
20 kHz	1500 Hz	20 kHz	10 kHz	20 kHz	20 kHz	20 kHz
–/–	–/–	–/–	LED/–	–/–	–/–	–/–
Current limiter	Cyclic	Current limiter	Cyclic	Current limiter	Current limiter	Current limiter

–25°C/+70°C	–25°C/+70°C	–25°C/+70°C	–25°C/+70°C	–25°C/+70°C	–25°C/+70°C	–25°C/+70°C
IP67	IP67	IP67	IP67	IP67	IP67	IP67
CuZn39Pb3	CuZn39Pb3	CuZn39Pb3	CuZn39Pb3	PA	PA	PA
3 x 0.14 mm ²	3 x 0.14 mm ²	3 x 0.14 mm ²	3 x 0.14 mm ²	3 x 0.14 mm ²	3 x 0.14 mm ²	3 x 0.14 mm ²

You will find detailed data sheets to the products under www.bernstein.eu



Electronic Magnetic Sensors (Type E45, E50)

Type	E45		E50	
Operating mode	Hall	Hall	Hall	Hall
Magnetic sensitivity (mT)	10 mT	10 mT	10 mT	10 mT
Sensing distance (S _n)	17 mm	17 mm	17 mm	17 mm
Reference magnet (Page)	T-62 N/S	T-62 N/S	T-62 N/S	T-62 N/S
Type of connection	Cable 2 m	Cable 2 m	Cable 2 m	Cable 2 m
Special feature				

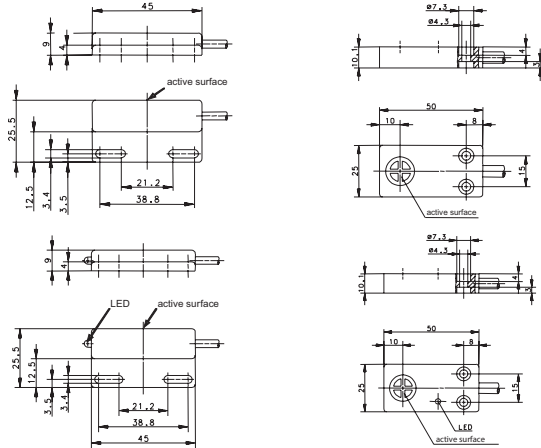

PNP	NO contact	6372245079 MEK-E45PS/H10-KL2	6372290081 MEK-E50PS/H10-KL2		
	Type				
	NC contact	6372145080 MEK-E45PÖ/H10-KL2	6372190082 MEK-E50PÖ/H10-KL2		
	Type				
NPN	Bistable	6373445129 MEK-E45PB/H11-KL2	6373490130 MEK-E50PB/H11-KL2		
	Type				
	NO contact	6362645009 MEK-E45NS/H10-K2	6362690011 MEK-E50NS/H10-K2		
Analogue	Type				
	NC contact	6363845040 MEK-E45NB/H11-K2	6363890042 MEK-E50NB/H11-K2		
	Bistable				
	Type				
	Current output				
	Voltage output				

Technical data

Rated operating voltage	U _B	4.5–24 VDC	10–39 VDC	4.5–24 VDC	10–39 VDC
Rated operating current	I _B	25 mA	400 mA	25 mA	400 mA
Max. switching voltage	F	20 kHz	10 kHz	20 kHz	10 kHz
Function/operating voltage indicator		–/–	LED/–	–/–	LED/–
Sensitivity adjustable					
Short circuit-protection		Current limiter	Cyclic	Current limiter	Cyclic
Teachable					

Mechanical data

Ambient temperature (min/max)		–25°C/+70°C	–25°C/+70°C	–25°C/+70°C	–25°C/+70°C
Protection class in accordance with IEC 529, EN 60529		IP67	IP67	IP67	IP67
Enclosure material		PA	PA	PBT	PBT
Connection		3 x 0.14 mm ²	3 x 0.14 mm ²	3 x 0.50 mm ²	3 x 0.50 mm ²

Please refer to Accessories for magnets, mounting brackets, cable couplers and sensor tester.



Programmable Miniature Position Sensors with Fully Integrated Electronics

The teachable magnetic sensors are characterised by one or two freely programmable, independent switching points. Despite this high degree of functionality, BERNSTEIN has succeeded in integrating the entire electronics into a compact sensor enclosure with the smallest possible dimensions. This design feature renders additional protection (e.g. for the cable electronics or high-cost safeguards) unnecessary.

The compact design is suitable for installation in all standard T- and C-slots (e.g. FESTO or SMC). In an installed position, the freely programmable switching points can be quickly and easily set with the aid of the easy-to-use teach-in tool.

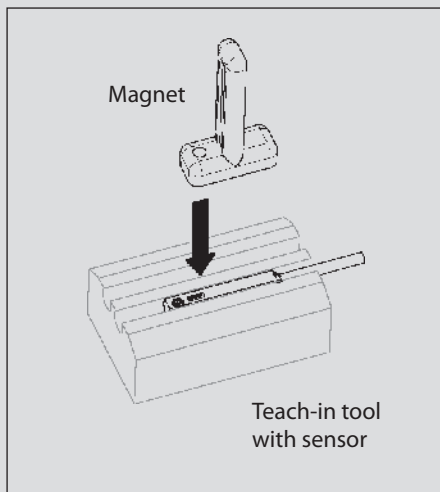

- The installed sensor assumes programming mode when the teach-in tool is placed over it
- The positions of the magnet are assigned to the respective outputs by correspondingly aligning the tool
- The programmable switching points are stored in the sensor
- The switching points can be changed by repeating the teach-in procedure

This configuration largely avoids unintentional changes to the settings and substantially increases the resistance to environmental influences while retaining the protection class rating.

Manually searching for the switching points has been replaced by rapid electronic balancing with the sensor installed in position. LEDs at the top of the sensor serve as the function indicator, provide information on the programming status and also signal faults. In addition to featuring effective polarity reversal protection as standard, the sensors also have an internal EEPROM that stores the switching points in the event of power failure.

Advantages

- Completely integrated electronic solution
- Permanent protection rating
- No need for additional electronics
- Fully immersed and therefore protected installation in the slot
- Suitable for standard C- and T-slots
- Available as cable or plug version
- Occupies only one slot
- Freely programmable switching points
- Straightforward teach-in procedure
- Reduced installation and wiring requirements
- Can be fitted from above
- High switching accuracy

Technical data

- PNP/NO contact
- Magnetic sensitivity $\pm 1.5 \text{ mT}$ to $\pm 13.5 \text{ mT}$
- Sensing distance up to 50 mm (depending on magnet/air gap)
- Repeat accuracy $\leq 0.1 \text{ mT}$
- Hysteresis $1 \text{ mT} \leq H \leq 1.35 \text{ mT}$
- Operating voltage range 10 – 30 V DC
- Output current $I_e \leq 50 \text{ mA}$ (one output switched) $\leq 25 \text{ mA}$ per output (both outputs switched)
- Ambient temperature $-20 \text{ }^\circ\text{C}$ to $+80 \text{ }^\circ\text{C}$
- Protection class IP67

Other slot sensors

Sensors with only one output can also be used for applications that require only one switching point. For this purpose BERNSTEIN offers a range of Hall sensors with set sensitivity or reed contact versions that do not require auxiliary energy.

All sensors come with the following accessories:

- 1x setscrew M2 x 3 (E22), M3 x 6 (E30), DIN 913
- 1x Offset screwdriver (E22)
- 1x Teach-in tool
- 1x Operating and installation instructions

Standards and approvals

MEK E-22/MEA E30
EN 60947-5-2



Teachable Electronic Slot Sensors

Type	E22		E30	
Operating mode	Hall	Hall	Hall	Hall
Magnetic sensitivity (mT)	1.5 – 13.5 mT	1.5 – 13.5 mT	1.5 – 13.5 mT	1.5 – 13.5 mT
Switching function	PNP NO / 0 – 10 V	PNP NO / 0 – 10 V	PNP NO / 0 – 10 V	PNP NO / 0 – 10 V
Reference magnet (Page)				
Type of connection	Cable 2 m	Connector M8	Cable 2 m	Connector M8

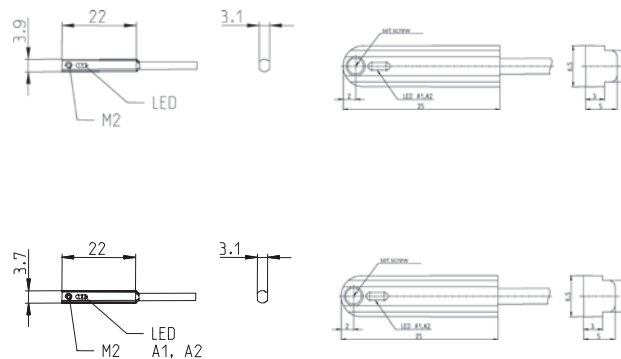

Type Double-channel	C-slot SMC Type	6370281183 MEK-E22PS/HP2-KL2	6370281184 MEK-E22PS/HP2-KL0,3S8	6370299187 MEA-E30PS/HP2-KL2	6370299188 MEA-E30PS/HP2-KL0,3S8
	C-slot Festo Type	6370281185 MEK-E22PS/HP2-KL2	6370281186 MEK-E22PS/HP2-KL0,3S8		
Type Single-channel	T-slot Type	6372281177 MEK-E22PS/HP1-KL2	6372281178 MEK-E22PS/HP1-KL0,3S8	6372299181 MEA-E30PS/HP1-KL2	6372299182 MEA-E30PS/HP1-KL0,3S8
	C-slot Festo Type	6372281179 MEK-E22PS/HP1-KL2	6372281180 MEK-E22PS/HP1-KL0,3S8		
Analogue 0 – 10 V	T-slot Type		6370081168 MEK-E-22A10/H50-KL0,3S8		6370099169 MEA-E30A10/H50-KL0,3S8
	C-slot Festo Type		6370081170 MEK-E22A10/H50-KL0,3S8		

Technical data

Rated operating voltage	U_B	10–30 VDC	10–30 VDC	10–30 VDC	10–30 VDC
Rated operating current	I_B	≤ 50 mA	≤ 50 mA	≤ 50 mA	≤ 50 mA
Max. switching voltage	F				
Function/operating voltage indicator		LED/–	LED/–	LED/–	LED/–
Sensitivity adjustable		Yes	Yes	Yes	Yes
Short circuit-protection		Cyclic	Cyclic	Cyclic	Cyclic
Teachable		Yes	Yes	Yes	Yes

Mechanical data

Ambient temperature (min/max)		–20°C/+80°C	–20°C/+80°C	–20°C/+80°C	–20°C/+80°C
Single-channel / Double-channel		+5°C/+55°C	+5°C/+55°C	+5°C/+55°C	+5°C/+55°C
Analogue 1 – 10 V					
Protection class in accordance with IEC 529, EN 60529		IP67	IP67	IP67	IP67
Enclosure material		PA	PA	Aluminium	Aluminium
Connection		4 x 0.05 mm ²	M8 x 1	4 x 0.05 mm ²	M8 x 1

Please refer to Accessories for magnets, mounting brackets, cable couplers and sensor tester.



Type	E22		E30	
Operating mode	Hall	Hall	Hall	Hall
Magnetic sensitivity (mT)	3 mT	3 mT	3 mT	3 mT
Switching function	PNP NO	PNP NO	PNP NO	PNP NO
Reference magnet (Page)				
Type of connection	Cable 2 m	Connector M8	Cable 2 m	Connector M8

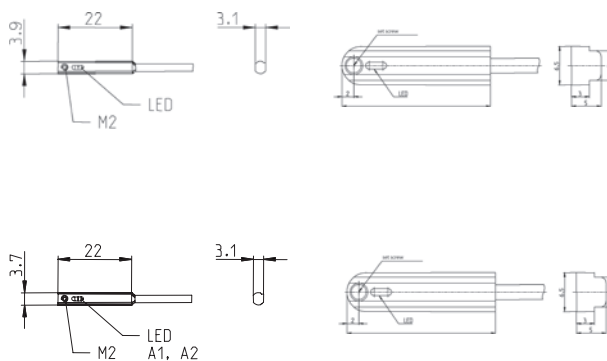

Type	C-slot SMC Type	6372281171	6372281172			
	C-slot Festo Type	MEK-E22PS/H03-KL2	MEK-E22PS/H03-KL0,3S8			
	T-slot Type	6372281173	6372281174			
		MEK-E22PS/H03-KL2	MEK-E22PS/H03-KL0,3S8	6372299175	6372299176	
				MEA-E30PS/H03-KL2	MEA-E30PS/H03-KL0,3S8	

Technical data

Rated operating voltage	U_b	10–30 VDC	10–30 VDC	10–30 VDC	10–30 VDC
Rated operating current	I_b	≤ 50 mA	≤ 50 mA	≤ 50 mA	≤ 50 mA
Max. switching voltage	F				
Function/operating voltage indicator		LED/–	LED/–	LED/–	LED/–
Sensitivity adjustable		Yes	Yes	Yes	Yes
Short circuit-protection		Cyclic	Cyclic	Cyclic	Cyclic
Teachable		–	–	–	–

Mechanical data

Ambient temperature (min/max)	–20°C/+80°C	–20°C/+80°C	–20°C/+80°C	–20°C/+80°C
Protection class in accordance with IEC 529, EN 60529	IP67	IP67	IP67	IP67
Enclosure material	PA	PA	Aluminium	Aluminium
Connection	3 x 0.05 mm ²	M8 x 1	3 x 0.05 mm ²	M8 x 1

Please refer to Accessories for magnets, mounting brackets, cable couplers and sensor tester.



Slot Sensors with Reed Contact

Type	E22		E30	
Operating mode	Reed	Reed	Reed	Reed
Magnetic sensitivity (mT)	3 mT	3 mT	3 mT	3 mT
Switching function	NO	NO	NO	NO
Switching power	10 VA	10 VA	10 VA	10 VA
Type of connection	Cable 2 m	Connector M8	Cable 2 m	Connector M8

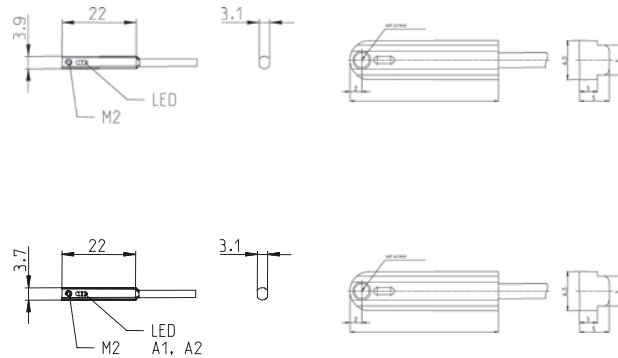

Type	C-slot SMC Type C-slot Festo Type T-slot Type	6310281741 MAK-E22S/R20-2	6310281742 MAK-E22S/R20-0,3S8	6310281743 MAK-E22S/R20-2	6310281744 MAK-E22S/R20-0,3S8	6310299745 MAA-E30S/R20-2	6310299746 MAA-E30S/R20-0,3S8

Technical data

Rated operating voltage U_b	120 V	120 V	120 V	120 V
Performance class (diagram No.)	10 VA	10 VA	10 VA	10 VA
Shock resistance	30 g (11 ms)	30 g (11 ms)	30 g (11 ms)	30 g (11 ms)
Reproducibility	+/- 1 mm	+/- 1 mm	+/- 1 mm	+/- 1 mm
Mechanical service life (switching operations)	3×10^8	3×10^8	3×10^8	3×10^8

Mechanical data

Ambient temperature (min/max)	-25°C/+80°C	-25°C/+80°C	-25°C/+80°C	-25°C/+80°C
Protection class in accordance with IEC 529, EN 60529	IP67	IP67	IP67	IP67
Enclosure material	PA	PA	Aluminium	Aluminium
Connection	$3 \times 0.05 \text{ mm}^2$	M8 x 1	$3 \times 0.05 \text{ mm}^2$	M8 x 1

You will find detailed data sheets to the products under www.bernstein.eu



Contactless safety technology

To complement the extensive range of mechanical safety switches offered by BERNSTEIN, a new series of contactless safety switches is now available. These safety sensors ensure that safety doors and protective guards remain closed when danger is present.

The contactless safety technology offers the following advantages:

- Wear-free actuating
- Very easy to clean
- No actuator, therefore:
 - No mechanical damage possible
 - No hazards or restrictions caused by protruding actuator
- Switching function not affected by contaminants

BERNSTEIN offers two different technologies in the field of contactless safety technology:

- Safety sensors on magnetic basis, MAK series
- Safety sensors on RFID basis, CSMS series

Safety sensors CSMS

The CSMS can directly be connected to contactors or to an evaluation unit (dependent on the respective model). The RRS version integrates an evaluation of a return circuit and start button with direct connection to contactors. With the CSMS, PL e and SIL 3 is achieved. This is the case with only one CSMS and also with series circuits with up to 32 sensors the case.



Product features

- Performance Level e
- Up to 32 series circuits without leaving the PL e
- Power supply 24 V DC
- High coding level corresponding to the draft DIN EN ISO 14119
- No need of any additional external monitoring (dep. on the type)
- Connection of return circuit and start button possible (dep. on the type)
- Output current up to 250 mA per safety output
- Large diagnostic possibility
- 3 LEDs for status information of the CSMS
- Switching distance: 13 mm
- Dimensions: 110 mm x 30 mm x 15 mm
- IP 67

Safety sensors MAK

To achieve a PL or SIL value with the MAK safety sensors, it is necessary to connect them to a safety evaluation unit. The magnetic safety sensors are dual channel versions. The evaluation unit (BERNSTEIN designation: MÜZ) monitors the correct switching of the two MAK channels and a defined time window in which the two channels must switch.

With the combination of MAK and MÜZ, a PL D and a SIL 3 can be reached. Besides the 3 different types of magnetic safety switches, BERNSTEIN also offers two different evaluation units.



Product features

- Performance Level d
- Redundancy with NO and NC contacts
- Switching distance: 6 mm
- IP 67

Comparison CSMS – MAK

Product characteristics	CSMS	MAK
Operating principle	elektro-magnetic, RFID	magnetic, Reed
Safety parameters	PL e, SIL3	PL d, SIL 3
Safety outputs	electrical outputs	mechanical contacts
Can be switched in series	yes, when a constant safety level is guaranteed	yes, with falling safety level
Evaluation unit required	no	yes
Actuator coding	high	low
Sensing distance	13 mm	3–4 mm
Diagnostic interface	via LED and electronically	no
Mechanical sensitivity	low	very high
Approach possibility of the actuator	4	1
Safety outputs	2	1
Return circuit evaluation	yes	partially (depending on the evaluation unit)
Start button monitoring	yes	partially (depending on the evaluation unit)

The **CSMS** is a future-proofed safety product. The CSMS is a contactless safety sensor that uses RFID technology. It can be used as a single device as well as being connected in series up to PL e and SIL 3. BERNSTEIN offers two general product versions.

● CSMS-...-RRS... ①

With this product version, safety sensors can be connected to contactors without using an evaluation device. The product has an integrated evaluation of the return circuit and allows connection of a start button.

● CSMS-...-R... ②

This product version can be connected to a safety evaluation unit. Optionally, another safety sensor can be connected to the first CSMS with OSSD output (e.g. light curtains).

Both versions have extensive diagnostic capabilities. This is transmitted over a communication channel to a diagnostic device. This is displayed via PNP outputs if the CSMS is opened or closed. Moreover, it is possible to obtain information about the system and the sensor via integrated LEDs.

In order to ensure a particularly high manipulation protection (according to draft DIN EN ISO 14119), each sensor is assigned to one actuator. Thus, it is ensured that the CSMS cannot be "tricked" with different actuators.

The fast and accurate connection of the CSMS is realised by M12 connector cables and T-pieces.

● CSMS-...-A... ③

This product version allows a direct connection of several safety sensors to the safety controller by parallel wiring.

Connection example

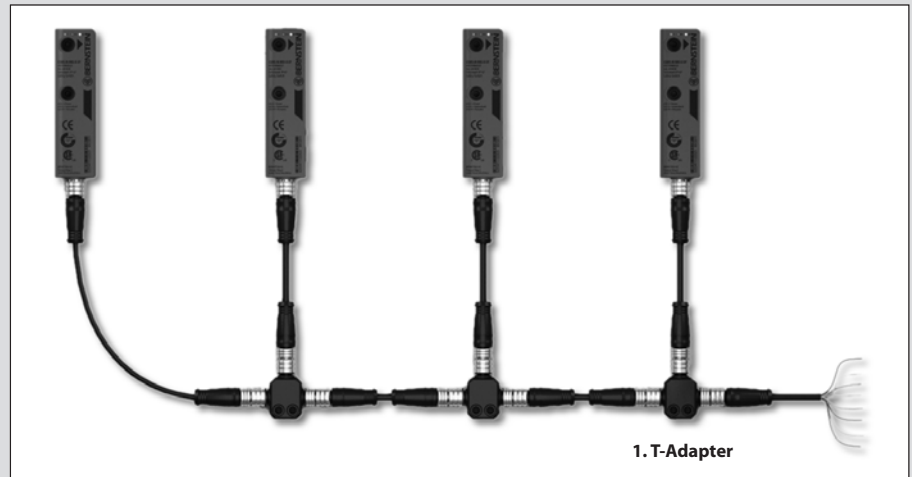

T-Adapters to be used

Versions	Start function	1. T-Adapter	Following T-Adapter
Version RRS	Manual start Automatic start	Grey Black	Black Black
Version R		Grey	Black

Application examples

① CSMS Series circuits without additional evaluation

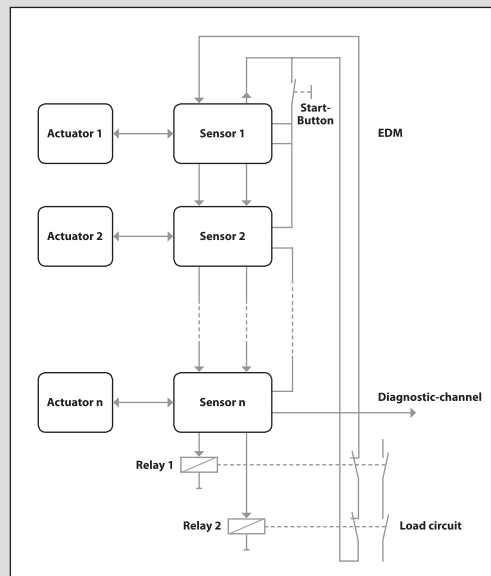

② CSMS Series circuits with evaluation device

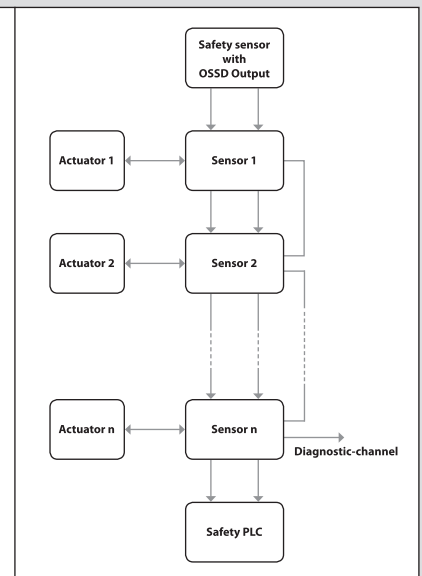

③ CSMS Parallel connection to a safety controller

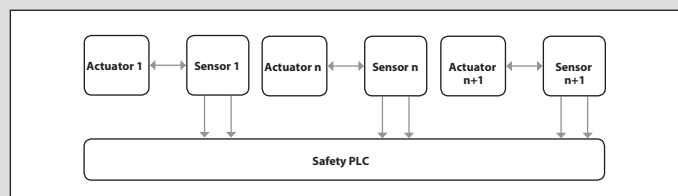

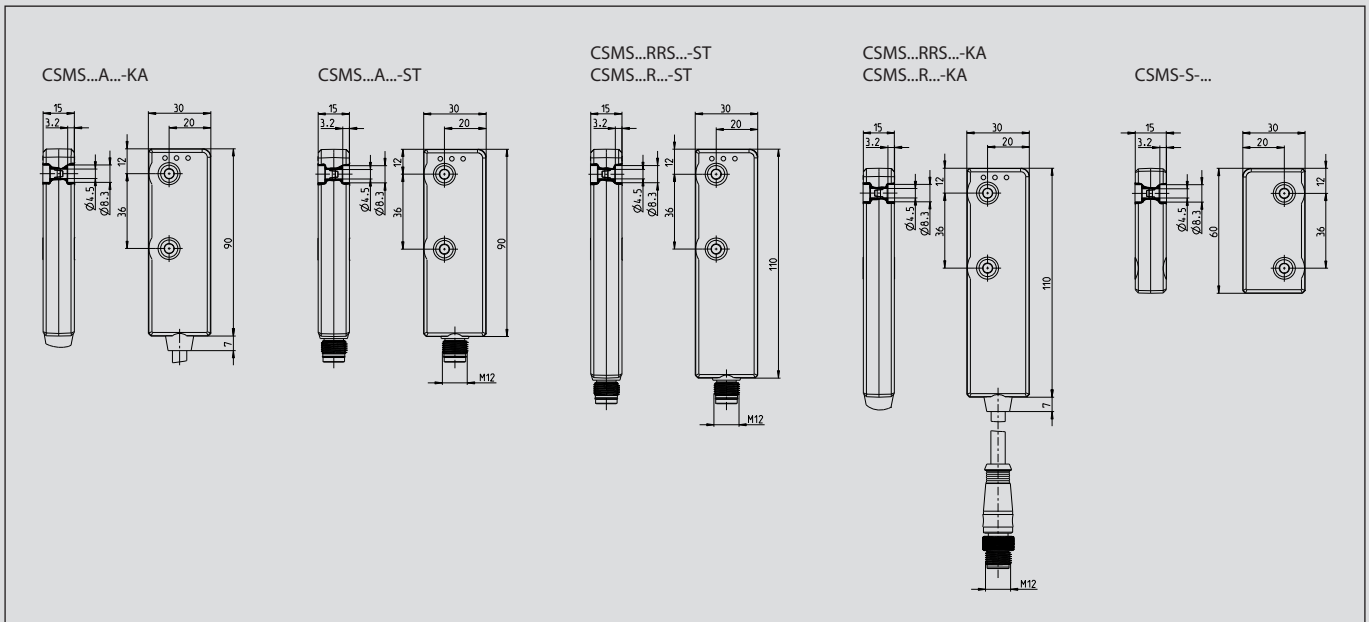

According to **ISO 14119**, interlocking devices are mechanical or electrical devices which are designed to prevent the operation of a machine element for as long as the movable safety guard is left open.

The CSMS based on RFID is contactless and fulfils the highest requirement (high-level coding) of protection against manipulation of **ISO 14119**.

The BERNSTEIN CSMS offers both a high-level coding and a low-level coding, in order to provide the optimum protection against manipulation for each application.

The safety-related capacity of the CSMS is demonstrated through full observation of the following standards:

- Requirements for safety-related parts of control systems up to **PL e in accordance with ISO 13849-1**
- Functional safety up to **SIL 3 in accordance with IEC 62061**
- Choice and use of safety-related interlocking devices of **type 4 in accordance with ISO 14119**

unicode/high coding:
Sensor accepts only one actuator
multicode/low coding:
Sensor accepts several actuators

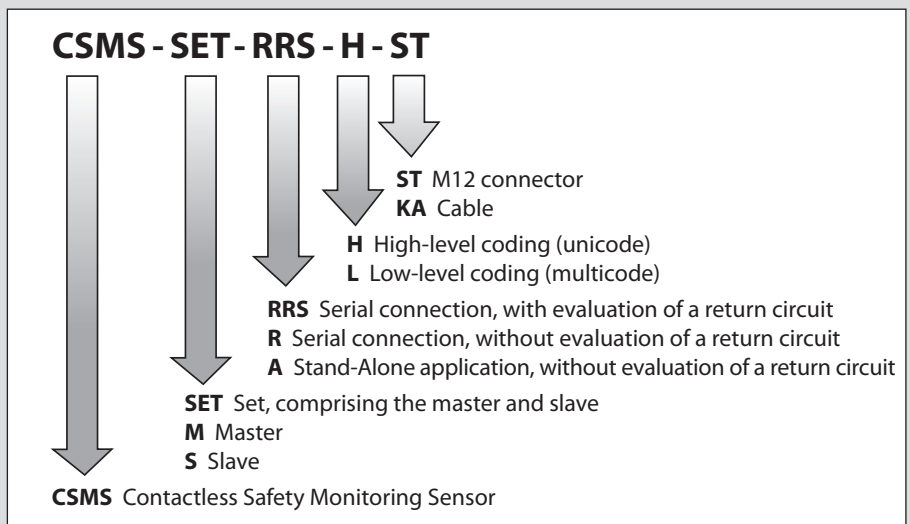

Sensing distance

Rated sensing distance	S_n	13 mm
Assured sensing distance – (On)	S_{ao}	min. 10 mm
Hysteresis	H	0,5 mm
Assured sensing distance – (Off)	S_{ar}	max. 19 mm

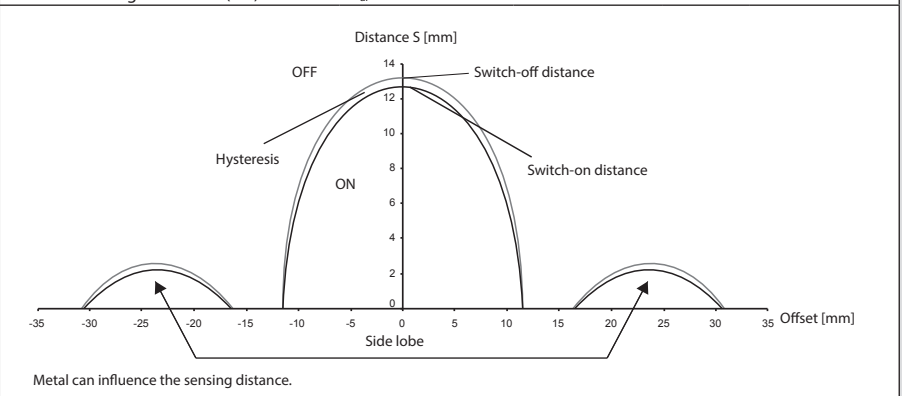

To achieve the stated sensing distances on metal substrates, CSMS spacers must be used.

CSMS-RRS with evaluation of a return circuit

Advantages

- Individual CSMS or safe serial connection with max. 32 CSMS up to **PL e**
- Manual or automatic start
- No external safety evaluation unit required
- Uni- or multi-coding
- Integrated evaluation of a return circuit and start button with direct connection to contactors

Unicode	Multicode	M12 connector	2 m cable + M12 connector	Article number	Designation
x			x	6075988057	CSMS-SET-RRS-H-KA
x		x		6075988058	CSMS-SET-RRS-H-ST
	x	x		6075988066	CSMS-SET-RRS-L-ST
	x		x	6075988068	CSMS-SET-RRS-L-KA
x			x	6075985048	CSMS-M-RRS-H-KA
x		x		6075986050	CSMS-M-RRS-H-ST
	x		x	6075985061	CSMS-M-RRS-L-KA
	x	x		6075986062	CSMS-M-RRS-L-ST
	Replacement actuator Multicode			6075980065	CSMS-S-L
	Replacement actuator Unicode			6075980052	CSMS-S-H*

*Must be taught in with 6075989056 (CSMS SLAVE TEACHADAPTER) for the master.

CSMS-R for the connection to a safety evaluation unit

Advantages

- Safe serial connection with max. 32 CSMS up to **PL e**
- Connection to an external safety evaluation unit for ex. SCR ON
- Optional: Connection of a safety sensor (for ex. safety light curtain) with OSSD output to the first CSMS
- Uni- or multi-coding

Unicode	Multicode	M12 connector	2 m cable + M12 connector	Article number	Designation
x			x	6075988059	CSMS-SET-R-H-KA
x		x		6075988060	CSMS-SET-R-H-ST
	x	x		6075988067	CSMS-SET-R-L-ST
	x		x	6075988069	CSMS-SET-R-L-KA
x			x	6075985049	CSMS-M-R-H-KA
x		x		6075986051	CSMS-M-R-H-ST
	x		x	6075985063	CSMS-M-R-L-KA
	x	x		6075986064	CSMS-M-R-L-ST
	Replacement actuator Multicode			6075980065	CSMS-S-L
	Replacement actuator Unicode			6075980052	CSMS-S-H*

*Must be taught in with 6075989056 (CSMS SLAVE TEACHADAPTER) for the master.

CSMS-A for direct connection to a control unit

Advantages

- Up to **PL e / SIL 3**
- Multi-coding
- Compact construction
- Connection to an external safety evaluation unit for ex. SCR ON

Unicode	Multicode	M12 connector	2 m cable	Article number	Designation
	x	x		6075988072	CSMS-SET-A-L-ST
	x		x	6075988073	CSMS-SET-A-L-KA
	x		x	6075985070	CSMS-M-A-L-KA
	x	x		6075986071	CSMS-M-A-L-ST
	Replacement actuator Multicode			6075980065	CSMS-S-L

CSMS diagnosis

The CSMS product family offers one of the largest diagnostic options on the market. Opened protective devices or actuators in the transitional area as well as system failures can be rapidly and precisely identified. Due to the optional diagnostic devices, the status of each CSMS appears in the security chain.



- Status display of each CSMS in the security chain
- Electronical outputs or bus interface

CSMS Standard Diagnosis

The CSMS Standard Diagnosis has 8 or 16 electronic outputs. Each output is assigned to one CSMS. It is possible to switch on the output, even at the maximum operating distance. The output is switched by dip switches on the diagnostic device. In maximum system conception, the status of all 32 CSMS can be displayed simply by cascading the diagnostic devices.

CSMS Diagnosis Profibus

The CSMS Diagnosis Profibus with Profibus interface ensures the direct transmission of the diagnostic information from each CSMS to the control unit. Advantages include considerably reduced wiring expenses, a clearer arrangement and a substantially higher functionality. As well as protective devices in an open position or in the transitional area, attempts to tamper with the machine and system errors can also be detected. The machine down time can be reduced to a minimum by the extensive diagnostic options. Further bus systems on request.

Parallel connection

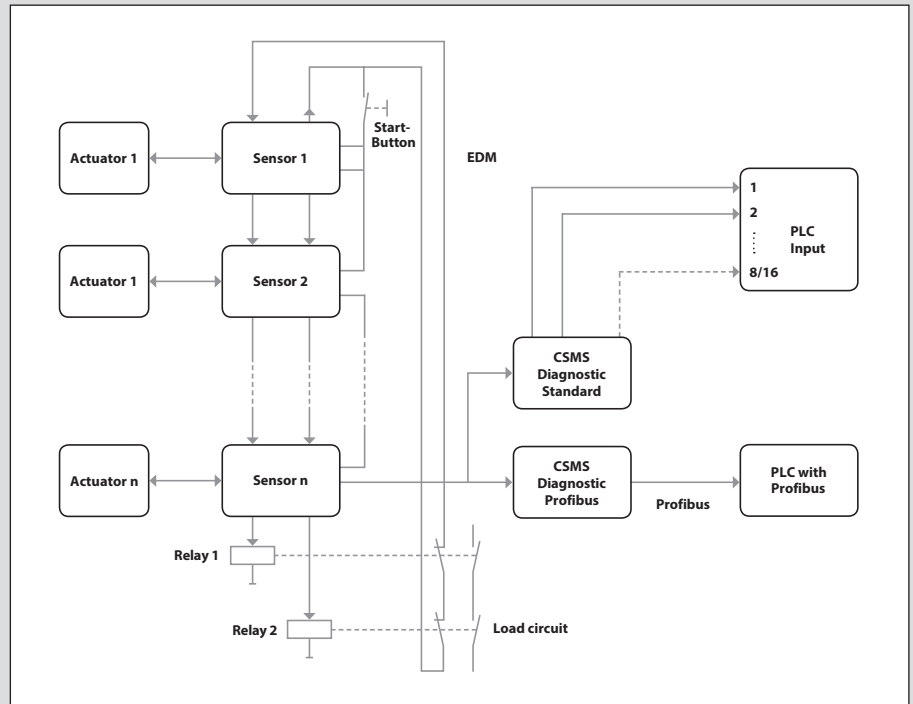

Article number	Designation	Description
6075989031	CSMS DIAGNOSE STANDARD 8	Diagnosis for 8 CSMS
6075989032	CSMS DIAGNOSE STANDARD 16	Diagnosis for 16 CSMS
6075989033	CSMS DIAGNOSE PROFIBUS	Profibus Gateway

Magnetic controllers for safety functions

BERNSTEIN offers magnetic controllers for safety functions that fulfill performance level d according to EN 13849-1 and SIL 3 according to EN 61508 or rather EN 62061.

A safety system consists of the safety magnetic controllers and a coded transducer unit.

The anti-tamper security of the transducer unit is achieved by variable coding of the actuator magnets and magnetic switches.

The safety magnetic controller processes the NC or NO contact signals coming from the coded magnetic switches. Thereby, it is possible to detect the opening of the safety guard (door, hatch, protective hood etc.) and to turn off the safety output. Thanks to the redundant evaluation, the magnetic controller is switched to the "safe state" should a fault or manipulation occur, or if the time difference is exceeded between the NC contact signal and the NO contact signal. An LED indicates that the safety magnetic controller is in the "safe state".

To ensure fault detection of the switch-off device, the MÜZ-102 offers the possibility to connect a return circuit. The system additionally features a NC contact for signalling purposes.

- Redundancy by NO and NC contacts
- Manipulation safety by coding
- Monitoring of the return circuit (depending on device type)



Depending on the type of device, one or two coded transducer units (magnetic switch with corresponding magnet) of type:

- MAK-4236
- MAK-5236
- MAK-5336

can be connected to and monitored by the safety magnetic controllers.



MAK-4236-x with magnet TK-42-CD



MAK-5236-x with magnet TK-52-CD / 2



MAK-5336-x with magnet TK-43-CD

Safety Magnetic Controllers

Magnetic controllers for safety functions

TÜV certified

- EN ISO 13849-1 Performance Level d
- EN 61508 and EN 62061 SIL 3
- EN 60947-5-3 Single fault security S



Coded transducer units

Magnetic switches

Type designation	MÜZ-102/D24-FL-DA	MÜZ-202/D24-FL
Article number	6392701306	6392702307
Max. number of connectable transducer units	1	2
Safety output, NO contact	●	●
Feedback circuit	●	–
Data output (NC contact)	●	–
Technical data		
Operating voltage	24 V DC	24 V DC
Operating current	60 mA	60 mA

Switching capacity, safety output

Switching voltage	max	AC 250 V	AC 250 V
Switching current	max	8 A	8 A
Switching power	max	1700 VA	1700 VA
LED: Hazard status/switching status		●/–	●/–
LED: Supply voltage/ON		●	–
Relay: Positive-action/standard		●/–	●/–

Ambient conditions

Temperature range	min/max	0 °C/+55 °C	0 °C/+55 °C
		32 °F/+131 °F	32 °F/+131 °F
Protection class (to IEC 529, EN 60529)		IP20	IP20
Enclosure material		PC	PC
Mounting system (DIN 50022)		TS 35	TS 35
Type of connection: Terminal block		max. 2.5 mm ²	max. 2.5 mm ²

Type designation	
Article number	
Cable length	
Type designation	
Article number	
Cable length	

Type designation	
Article number	
Cable length	

Type designation	
Article number	
Cable length	

Ambient conditions		
Temperature range	min/max	
Protection class (to IEC 529, EN 60529)		
Enclosure material		
Sensing distance	S on	min
	S on	max

Actuating magnet	
Type designation	
Article number	
Use: safety magnetic controller	
Article number	

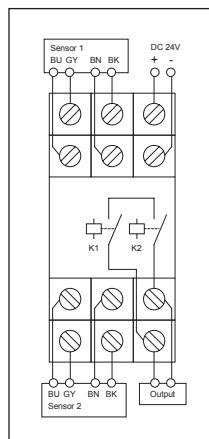
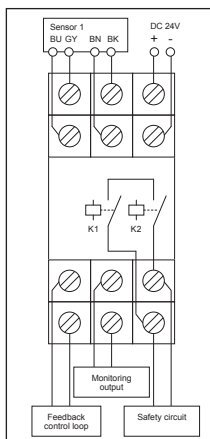
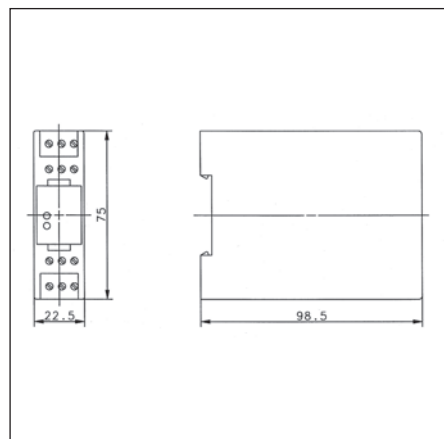

All dimensions in mm

Other types available on request.



MAK-4236-3 6490642315 3 m PVC cable	MAK-5236-3 6490652316 3 m PVC cable	MAK-5336-3 6490653317 3 m PVC cable
MAK-4236-6 6490642302 6 m PVC cable	MAK-5236-6 6490652307 6 m PVC cable	MAK-5336-6 6490653311 6 m PVC cable
MAK-4236-9 6490642303 9 m PVC cable	MAK-5236-9 6490652308 9 m PVC cable	MAK-5336-9 6490653312 9 m PVC cable
MAK-4236-STK 6490642305 4-pin connector	MAK-5236-STK 6490652309 4-pin connector	MAK-5336-STK 6490653313 4-pin connector

-5 °C/+70 °C +23 °F/+158 °F	-5 °C/+70 °C +23 °F/+158 °F	-5 °C/+70 °C +23 °F/+158 °F
IP67	IP67	IP67
PA 6.6	PBT	PA 6.6
4 mm	3 mm	3 mm
14 mm	14 mm	14 mm

TK-42-CD 6402042310	TK-52-CD/2 6402052311	TK-43-CD 6402043312
6392701306	6392701306	6392701306
6392702307	6392702307	6392702307

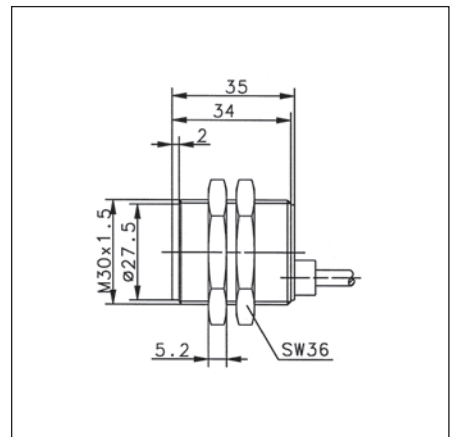
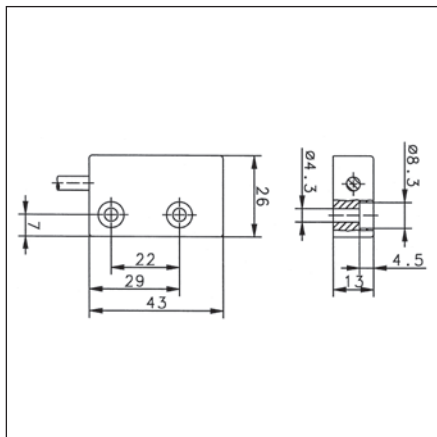
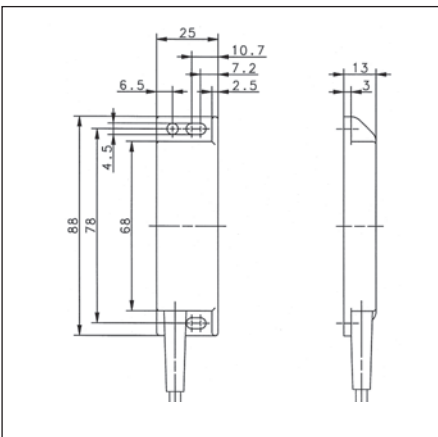

Ultrasonic Sensors

Ultrasonic sensors are used to precisely detect the position of objects of any material and colour, irrespective of external light levels even in harsh industrial environments. The sensors are characterised by high sound intensity that makes it possible to detect even the smallest of objects.

In addition to their high precision, outstanding repeatability and high degree of linearity their strengths also include their suitability for use in universal applications, irrespective of light conditions, as well as colour and material of the objects and substances to be detected.

Ultrasonic sensors produce accurate results even in connection with highly transparent objects such as film or glass surfaces and are completely unaffected by normal levels of soiling on the sensor surface. High performance under the most difficult operating conditions, even in suspended particle or water vapour environments, is a characteristic feature as is their ruggedness under harsh operating conditions.

Thanks to their outstanding properties ultrasonic sensors are used in a diverse range of applications and sectors of industry.

Measuring principle

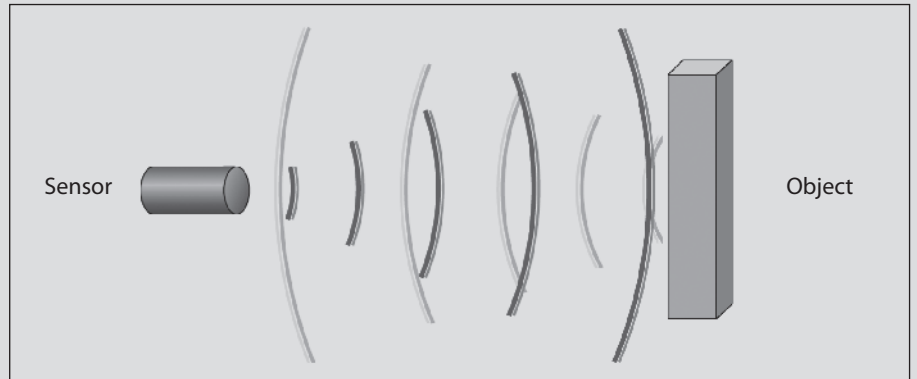

The sensor emits a sound pulse that is reflected from the object to be detected. The sensor reads in the reflected pulse and the distance to the object is determined by means of a runtime measurement routine.

Advantages

- Protection class IP 67
- Large detection range of up to 6000 mm (depending on type)
- High linearity
- High repeat accuracy
- Narrow sound beam of 8°
- Adaptive 0–10 V voltage or 4–20 mA current output (analogue sensors)
- Two adaptive switching outputs, can be used individually or combined in connection with switching sensors (depending on type)

Technical data*

- One analogue 0...10 V/4...20 mA output or two switching outputs.
- Rated operating voltage range 12 V – 30 V DC
- Enclosure: PBT/ GF30
- Ambient temperature –15 °C...70 °C
- Repeat accuracy $\pm 0.2\% \pm 2$ mm
- Hysteresis 1 %

* Please refer to the following catalogue pages and the corresponding datasheets for technical information on the individual products

Detection range:

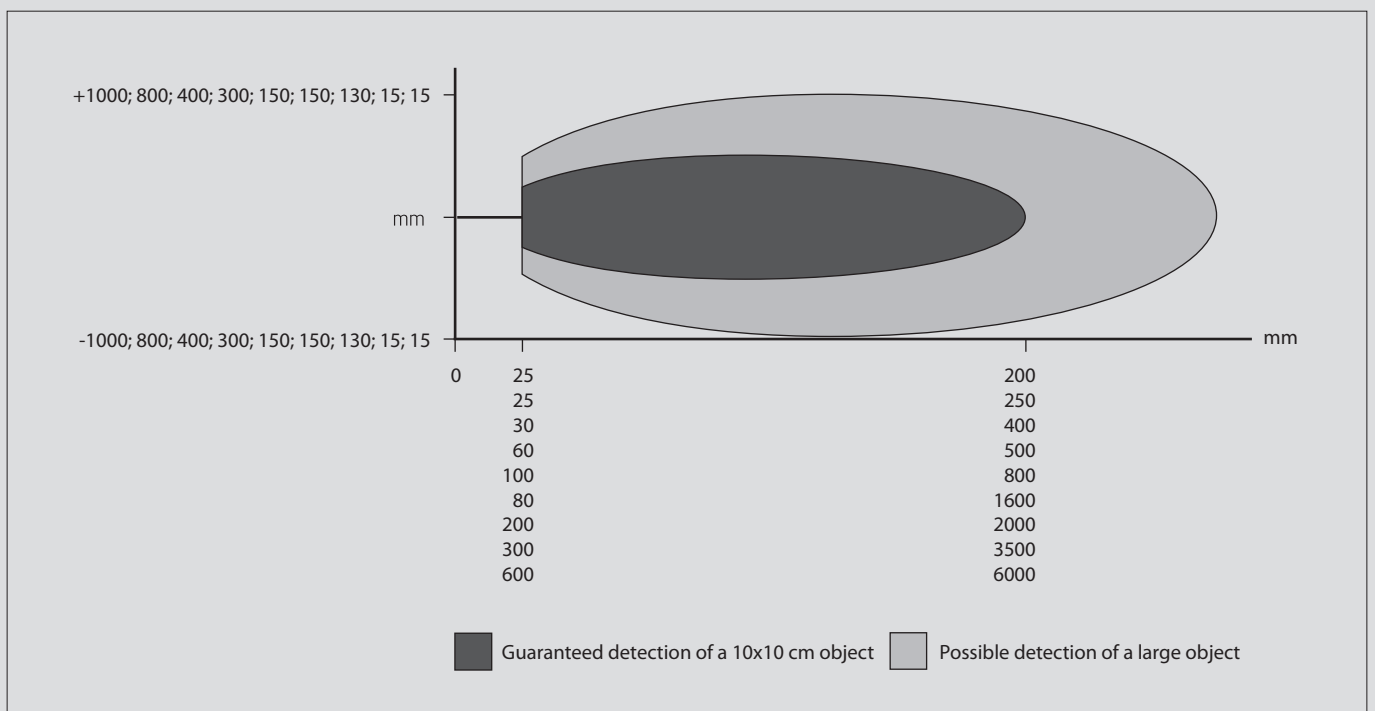

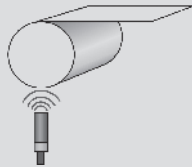
Application examples:

Wind-on and wind-off control

Detection of the diameter of coils in the paper, plastics and textile as well as metal working industries.

Sag control

Detection of sag loop for controlling material tension or controlling quantity of material for the downstream production process.

Level measurement

Level measurement of liquids of bulk materials in containers and silos.

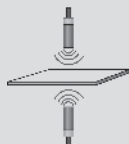
Thickness measurement

Thickness measurement of objects.

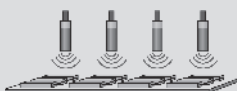
Completeness check

For checking completeness of objects in containers.

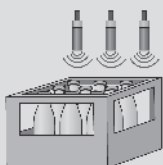
Completeness check of bottles in crates

For checking the presence and height of bottles in crates.

Teach-in procedure
Analogue sensors

Any interval within the measuring range can be selected for the analogue output by means of TeleTeach. The slope of the characteristic curve – positive or negative – can, of course, be set to any value.

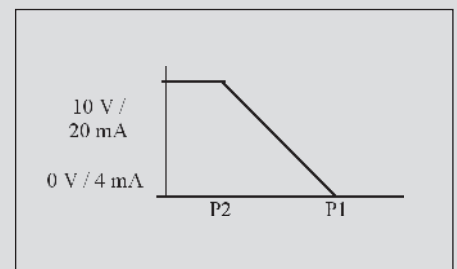
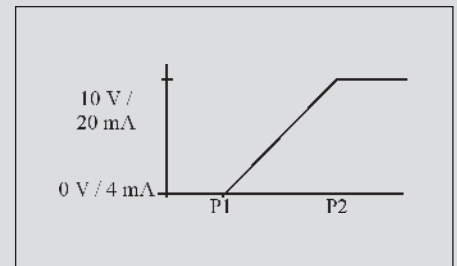

The points P1 and P2 determine the position of the analogue characteristic curve: P1 defines the point at which the characteristic curve assumes the value 0 V/4 mA, P2 defines the 10 V/20 mA point. In the case of a "positive characteristic curve", the sensor is programmed in such a way that the sensor-P1 distance is smaller than the sensor-P2 distance. Correspondingly, sensor-P2 distance is smaller than sensor-P1 distance for a "negative characteristic curve".

Switching sensors

The two switching outputs are taught-in accurate to the millimetre via a teach-in input. Independent of each other, they can be optionally adapted with 1 % hysteresis as complementary windows (NO / NC) or as complementary switching outputs (NO / NC) with hysteresis adjustable to any value. P1 and P2 define the position of the switching points. The switching point has NO characteristic if the corresponding LED is on while teaching in the switching point and conversely, it has NC characteristic when the LED is off. Two LEDs indicate the switching status of the sensor.

Standards and approvals:

EN 60947-5-2

Ultrasonic Sensors (Type M12, M18)

Type	M12	M18		M18	
Detection range	25–200 mm	30–400 mm	30–400 mm	30–400 mm	30–400 mm
Output	1 x NO/NC	2 x NO/NC	Analogue	2 x NO/NC	Analogue
Type of connection	Connector M12	Cable 2 m	Cable 2 m	Connector M12	Connector M12
Special feature					

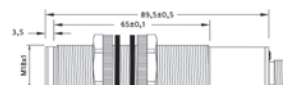
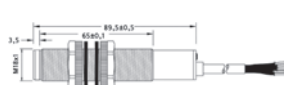
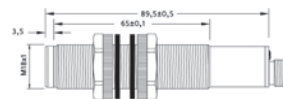
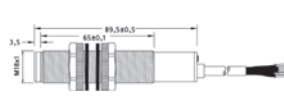
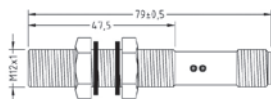

PNP	DC	NO/NC Type	6712101001 UN12I-DPE0-0200-S30	6711102005 UT18I-DPE0-0400-C30	6712102005 UT18I-DPE0-0400-S30
NPN	DC	NO/NC Type	6712201001 UN12I-DNE0-0200-S30	6711202005 UT18I-DNE0-0400-C30	6712202005 UT18I-DNE0-0400-S30
Analogue	DC	0–10 V Type 4–20 mA Type		6711402005 UT18I-D00U-0400-C30 6711302005 UT18I-D00I-0400-C30	6712402005 UT18I-D00U-0400-S30 6712302005 UT18I-D00I-0400-S30

Technical data

Rated operating voltage	U_B	12–30 VDC	12–30 VDC	15–30 VDC	12–30 VDC	15–30 VDC
Rated operating current	I_B	100 mA	500 mA	–	500 mA	–
Switching frequency (max)	F	20 Hz	15 Hz	–	15 Hz	–
Resolution		–	–	0.125 mm	–	0.125 mm
Linearity error		–	–	< 0.5 %	–	< 0.5 %
Response times		–	–	60 ms	–	60 ms
Repeatability		±0.3 %	±0.2 % ±1 mm	±0.2 % ±1 mm	±0.2 % ±1 mm	±0.2 % ±1 mm
Sound beam		12°	8°	8°	8°	8°
Short circuit-protection		Cyclic	Cyclic	Cyclic	Cyclic	Cyclic
Function/operating voltage indicator		LED/LED	LED/LED	LED/LED	LED/LED	LED/LED

Mechanical data

Ambient temperature (min/max)		–20°C/+70°C	–15°C/+70°C	–15°C/+70°C	–15°C/+70°C	–15°C/+70°C
Protection class in accordance with IEC 529, EN 60529		IP67	IP67	IP67	IP67	IP67
Enclosure material		Stainless steel	PBT/GF30	PBT/GF30	PBT/GF30	PBT/GF30
Connection		M12 x 1	5 x 0.14 mm ²	4 x 0.14 mm ²	M12 x 1	M12 x 1

Please refer to Accessories for cable couplers and sensor tester.



M18		M18		M18		M18	
60–500 mm	60–500 mm	60–500 mm	60–500 mm	80–1600 mm	80–1600 mm	80–1600 mm	80–1600 mm
2 x NO/NC	Analogue	2 x NO/NC	Analogue	2 x NO/NC	Analogue	2 x NO/NC	Analogue
Cable 2 m	Cable 2 m	Connector M12	Connector M12	Cable 2 m	Cable 2 m	Connector M12	Connector M12

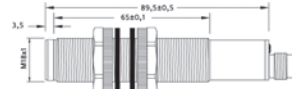
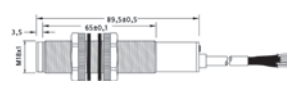
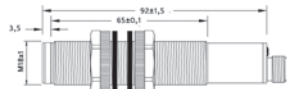
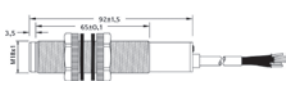
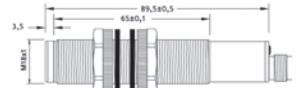
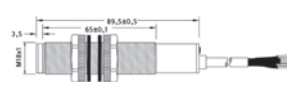
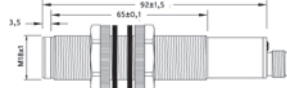
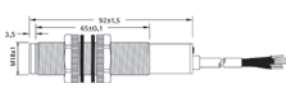

6711102004 UT18I-DPE0-0500-C30		6712102004 UT18I-DPE0-0500-S30		6711102002 UT18I-DPE0-01.6-C30		6712102002 UT18I-DPE0-01.6-S30	
6711202004 UT18I-DNE0-0500-C30		6712202004 UT18I-DNE0-0500-S30		6711202002 UT18I-DNE0-01.6-C30		6712202002 UT18I-DNE0-01.6-S30	
	6711402004 UT18I-D00U-0500-C30 6711302004 UT18I-D00I-0500-C30		6712402004 UT18I-D00U-0500-S30 6712302004 UT18I-D00I-0500-S30		6711402002 UT18I-D00U-01.6-C30 6711302002 UT18I-D00I-01.6-C30		6712402002 UT18I-D00U-01.6-S30 6712302002 UT18I-D00I-01.6-S30

12–30 VDC	15–30 VDC	12–30 VDC	15–30 VDC	12–30 VDC	15–30 VDC	12–30 VDC	15–30 VDC
500 mA	–	500 mA	–	500 mA	–	500 mA	–
10 Hz	–	10 Hz	–	6 Hz	–	6 Hz	–
–	0.25 mm	–	0.25 mm	–	1 mm	–	1 mm
–	< 0.5 %	–	< 0.5 %	–	< 0.5 %	–	< 0.5 %
–	100 ms	–	100 ms	–	140 ms	–	140 ms
±0.2 % ±1 mm	±0.2 % ±1 mm	±0.2 % ±1 mm	±0.2 % ±1 mm	±0.2 % ±2 mm	±0.2 % ±2 mm	±0.2 % ±2 mm	±0.2 % ±2 mm
8°	8°	8°	8°	8°	8°	8°	8°
Cyclic	Cyclic	Cyclic	Cyclic	Cyclic	Cyclic	Cyclic	Cyclic
LED/LED	LED/LED	LED/LED	LED/LED	LED/LED	LED/LED	LED/LED	LED/LED

–15°C/+70°C	–15°C/+70°C	–15°C/+70°C	–15°C/+70°C	–15°C/+70°C	–15°C/+70°C	–15°C/+70°C	–15°C/+70°C
IP67	IP67	IP67	IP67	IP67	IP67	IP67	IP67
PBT/GF30	PBT/GF30	PBT/GF30	PBT/GF30	PBT/GF30	PBT/GF30	PBT/GF30	PBT/GF30
5 x 0.14 mm ²	4 x 0.14 mm ²	M12 x 1	M12 x 1	5 x 0.14 mm ²	4 x 0.14 mm ²	M12 x 1	M12 x 1

You will find detailed data sheets to the products under www.bernstein.eu



Ultrasonic Sensors (Type M18, M30)

Type	M18		M18		M18	
Detection range	100–800 mm	100–800 mm	100–800 mm	100–800 mm	200–2000 mm	200–2000 mm
Output	2 x NO/NC	Analogue	2 x NO/NC	Analogue	2 x NO/NC	Analogue
Type of connection	Cable 2 m	Cable 2 m	Connector M12	Connector M12	Cable 2 m	Cable 2 m
Special feature						

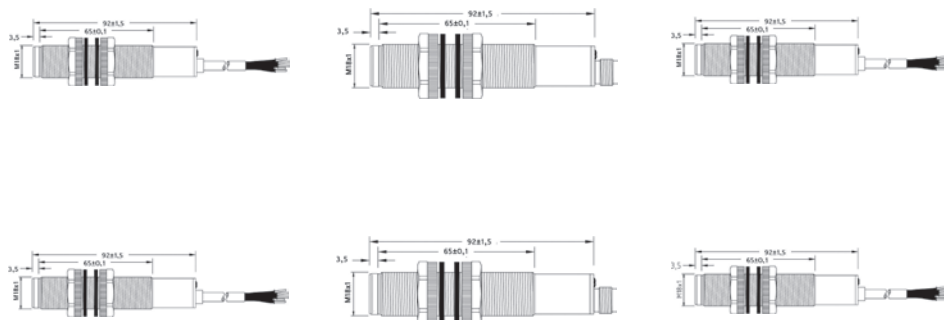

PNP	DC	NO/NC Type	6711102003 UT18I-DPE0-0800-C30	6712102003 UT18I-DPE0-0800-S30	6711102001 UT18I-DPE0-02.0-C30
NPN	DC	NO/NC Type	6711202003 UT18I-DNE0-0800-C30	6712202003 UT18I-DNE0-0800-S30	6711202001 UT18I-DNE0-02.0-C30
Analogue	DC	0–10 V Type 4–20 mA Type	6711402003 UT18I-D00U-0800-C30 6711302003 UT18I-D00I-0800-C30	6712402003 UT18I-D00U-0800-S30 6712302003 UT18I-D00I-0800-S30	6711402001 UT18I-D00U-02.0-C30 6711302001 UT18I-D00I-02.0-C30

Technical data

Rated operating voltage	U_B	12–30 VDC	15–30 VDC	12–30 VDC	15–30 VDC	12–30 VDC	15–30 VDC
Rated operating current	I_B	500 mA	–	500 mA	–	500 mA	–
Switching frequency (max)	F	10 Hz	–	10 Hz	–	5 Hz	–
Resolution		–	0.25 mm	–	0.25 mm	–	1 mm
Linearity error		–	< 0.5 %	–	< 0.5 %	–	< 0.5 %
Response times		–	100 ms	–	100 ms	–	200 ms
Repeatability		$\pm 0.2 \% \pm 1 \text{ mm}$	$\pm 0.2 \% \pm 1 \text{ mm}$	$\pm 0.2 \% \pm 1 \text{ mm}$	$\pm 0.2 \% \pm 1 \text{ mm}$	$\pm 0.2 \% \pm 2 \text{ mm}$	$\pm 0.2 \% \pm 2 \text{ mm}$
Sound beam		8°	8°	8°	8°	8°	8°
Short circuit-protection		Cyclic	Cyclic	Cyclic	Cyclic	Cyclic	Cyclic
Function/operating voltage indicator		LED/LED	LED/LED	LED/LED	LED/LED	LED/LED	LED/LED

Mechanical data

Ambient temperature (min/max)		–15°C/+70°C	–15°C/+70°C	–15°C/+70°C	–15°C/+70°C	–15°C/+70°C	–15°C/+70°C
Protection class in accordance with IEC 529, EN 60529		IP67	IP67	IP67	IP67	IP67	IP67
Enclosure material		PBT/GF30	PBT/GF30	PBT/GF30	PBT/GF30	PBT/GF30	PBT/GF30
Connection		5 x 0.14 mm ²	4 x 0.14 mm ²	M12 x 1	M12 x 1	5 x 0.14 mm ²	4 x 0.14 mm ²

Please refer to Accessories for cable couplers and sensor tester.



M18		M30		M30	
200–2000 mm	200–2000 mm	300–3500 mm	300–3500 mm	300–3500 mm	300–3500 mm
2 x NO/NC	Analogue	2 x NO/NC	Analogue	2 x NO/NC	Analogue
Connector M12	Connector M12	Cable 2 m	Cable 2 m	Connector M12	Connector M12

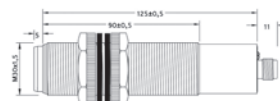
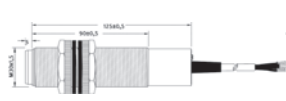
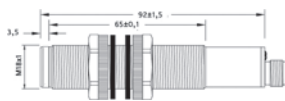
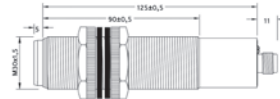
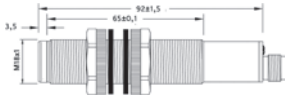

6712102001 UT18I-DPE0-02.0-S30		6711103001 UT30I-DPE0-03.5-C30		6712103001 UT30I-DPE0-03.5-S30	
6712202001 UT18I-DNE0-02.0-S30		6711203001 UT30I-DNE0-03.5-C30		6712203001 UT30I-DNE0-03.5-S30	
	6712402001 UT18I-D00U-02.0-S30 6712302001 UT18I-D00I-02.0-S30		6711403001 UT30I-D00U-03.5-C30 6711303001 UT30I-D00I-03.5-C30		6712403001 UT30I-D00U-03.5-S30 6712303001 UT30I-D00I-03.5-S30

12–30 VDC	15–30 VDC	12–30 VDC	15–30 VDC	12–30 VDC	15–30 VDC
500 mA	–	500 mA	–	500 mA	–
5 Hz	–	2.5 Hz	–	2.5 Hz	–
–	1 mm	–	1 mm	–	1 mm
–	< 0.5 %	–	< 0.5 %	–	< 0.5 %
–	200 ms	–	400 ms	–	400 ms
±0.2 % ±2 mm	±0.2 % ±2 mm	±0.2 % ±2 mm	±0.2 % ±2 mm	±0.2 % ±2 mm	±0.2 % ±2 mm
8°	8°	8°	8°	8°	8°
Cyclic	Cyclic	Cyclic	Cyclic	Cyclic	Cyclic
LED/LED	LED/LED	LED/LED	LED/LED	LED/LED	LED/LED

–15°C/+70°C	–15°C/+70°C	–15°C/+70°C	–15°C/+70°C	–15°C/+70°C	–15°C/+70°C
IP67	IP67	IP67	IP67	IP67	IP67
PBT/GF30	PBT/GF30	PBT/GF30	PBT/GF30	PBT/GF30	PBT/GF30
M12 x 1	M12 x 1	5 x 0.14 mm ²	4 x 0.14 mm ²	M12 x 1	M12 x 1

You will find detailed data sheets to the products under www.bernstein.eu



Ultrasonic Sensors (Type 40.5 x 26 x 12 mm, 80 x 80 x 50 mm)

Type	40.5 x 26 x 12 mm		80 x 80 x 50 mm	
Detection range	25–250 mm	25–250 mm	600–6000 mm	600–6000 mm
Output	1 x NO/NC	Analogue	2 x NO/NC	Analogue
Type of connection	Connector M8	Connector M8	Connector M12	Connector M12
Special feature				

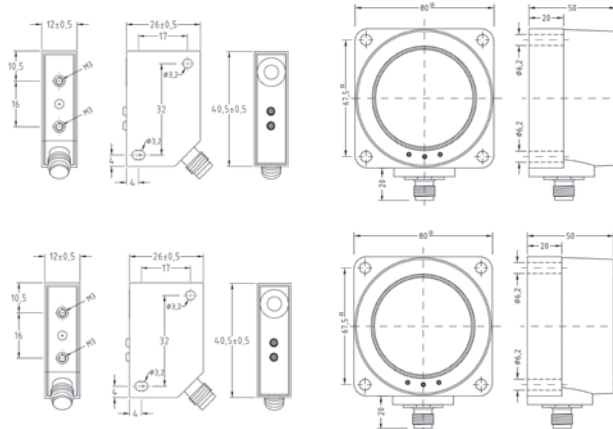

PNP	DC	NO/NC Type	6713111001 UT25I-DPE0-0250-V30	6712112001 UT80I-DPE0-06.0-S30		
NPN	DC	NO/NC Type	6713211001 UT25I-DNE0-0250-V30	6712212001 UT80I-DNE0-06.0-S30		
Analogue	DC	0–10 V Type 4–20 mA Type	6713411001 UT25I-D00U-0250-V30	6712412001 UT80I-D00U-06.0-S30 6712312001 UT80I-D00I-06.0-S30		

Technical data

Rated operating voltage	U_B	10–30 VDC	12–30 VDC	12–30 VDC	15–30 VDC
Rated operating current	I_B	100 mA	–	500 mA	–
Switching frequency (max)	F	20 Hz	–	1 Hz	–
Resolution		–	0.125 mm	–	1.5 mm
Linearity error		–	< 0.3 %	–	< 0.5 %
Response times		–	40 ms	–	700 ms
Repeatability		$\pm 0.2 \% \pm 0.2 \text{ mm}$	$\pm 0.2 \% \pm 0.2 \text{ mm}$	$\pm 0.2 \% \pm 2 \text{ mm}$	$\pm 0.2 \% \pm 2 \text{ mm}$
Sound beam		8°	8°	8°	8°
Short circuit-protection		Cyclic	Cyclic	Cyclic	Cyclic
Function/operating voltage indicator		LED/LED	LED/LED	LED/LED	LED/LED

Mechanical data

Ambient temperature (min/max)		–10°C/+70°C	–10°C/+70°C	–15°C/+70°C	–15°C/+70°C
Protection class in accordance with IEC 529, EN 60529		IP67	IP67	IP65	IP65
Enclosure material		PBT/GF30	PBT/GF30	PBT/GF30	PBT/GF30
Connection		M8 x 1	M8 x 1	M12 x 1	M12 x 1

Please refer to Accessories for cable couplers and sensor tester.



Float Switches

Design and Function

BERNSTEIN float switches are designed as contactless magnetic switches. They are used to control level in containers / tanks with non-flowing and / or flowing liquids such as water, oils, caustic solutions etc.

Float switches consist of a connection head, an immersion tube with one to four magnetic sensor elements and a float. Versions with straight or elbow immersion tube are available.

Rising or falling liquid levels carry the float equipped with a ring magnet into the detection zone of a magnetic sensor element, where the magnetic field of the float is evaluated and a switching pulse generated.

The range of BERNSTEIN float switches extends from miniature float switches through to heavy-duty, pressure-proof versions.

The combination options between various enclosure materials, floats and connection heads make it possible to create the optimum configuration for virtually any application.

Based on a comprehensive modular system of adjustable float switches, the product range offers an enormous problem solution potential. It allows the user to adjust the required switching points to individual applications, thus creating a customised product ideally adaptable to specific operating conditions.

BERNSTEIN additionally offers many other specific solutions that cannot all be illustrated in one catalogue. For more demanding applications it is therefore recommended to contact BERNSTEIN using a fax enquiry / Order form at the end of this section.



BERNSTEIN miniature float switches

To ensure smooth running operating processes, in many devices and industrial systems it is necessary to monitor product level in the most confined spaces.

These miniature float switches have been specially developed for small tanks / reservoirs as used in the automotive industry, drinks vending machines, air conditioning systems etc.

The NC / NO contact switching function in many miniature switches can be selected by simply turning the float by 180°.

This type of miniature float switch is also available with individual lengths of immersion tube.

BERNSTEIN adjustable float switches

Up to four encapsulated magnetic sensor elements can be placed in any position at 10 mm intervals in the immersion tube of BERNSTEIN adjustable float switches.

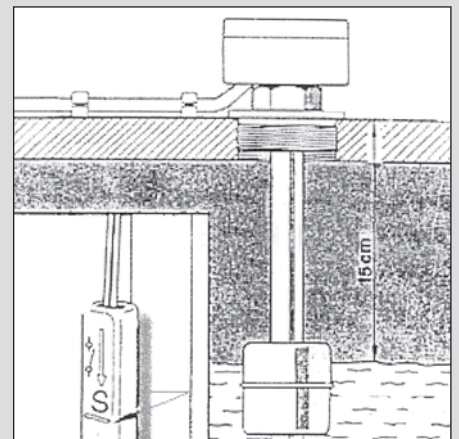

Thanks to their extremely user-friendly design, each of these universally used devices can replace several conventional switches.

Instead of keeping a large assortment of different switches in stock, the user requires only one single device.

The NC or NO contact switching function can be easily adapted to specific operating conditions.

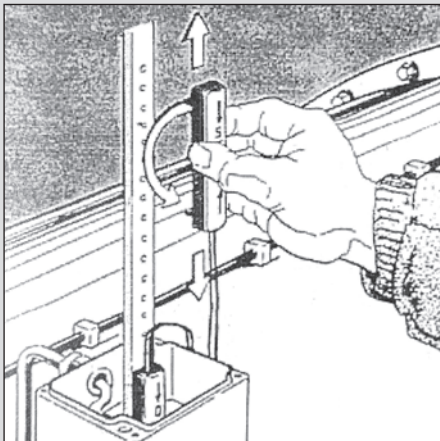

All versions are available as standard in four lengths (250, 500, 750 and 1000 mm). Other lengths are possible on request.



BERNSTEIN standard float switches

For over 25 years it has been hard to imagine fluid level regulation, control and monitoring systems without BERNSTEIN standard float switches. In addition to being used to simply provide a signal when a liquid level drops below or exceeds a defined value, they also ideally serve as signal generators in automatically operating filling systems.

With a wide range of different floats, enclosure materials and connection heads to choose from, the optimum float switch can be configured for virtually any application. Lengths of up to 2 m are possible. Versions are available with an elbow immersion tube in the connection head or even with a specially developed switching device.

Float Switches

Terminology and Basic Theory

Connection cable

Temperature resistant up to +70 °C, special versions up to +150 °C also available. Switches with cables come in the standard length of 1 m, other lengths are also possible on request.

Radian (y)

The radian is the length measured from the contact surface of the connection head to the neutral phase of the vertical immersion tube.

Chemical resistance

See "Chemical Resistance" table (Page 133).

Pressure

Up to 25 bar depending on type of float.

Disruptive breakdown voltage

Each float switch undergoes a high voltage test in accordance with DIN VDE 0160.

Maximum making current

From 0.5 A – 5 A depending on type of sensor used.

Immersion depth (h1)

Designates how far the float is immersed in the medium. This parameter is dependent on the density of the liquid as well as the size and weight of the float. The values listed in the catalogue refer to a density of 1.

End length (e)

From 36 mm to 50 mm depending on the type of float.

Electrical service life

To maintain a long service life of the float switches, it is important to ensure the maximum supply voltages and switching currents are not exceeded.

Spark quenching

On request, all BERNSTEIN float switches can be equipped with protection circuitry which prevents wear caused by switching sparks when switching inductive or capacitive loads (please refer to protective circuitry for reed contacts).

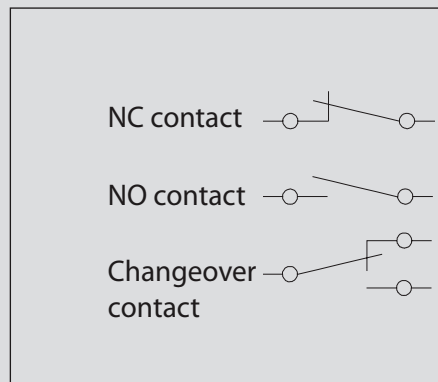

Contact function

Performance diagram

The performance diagram shows the switching capacity as a function of the switching current (please refer to Page 67).

Miniature float switches

Favourable design and compact dimensions allow these float switches to be used in smallest containers.

Mechanical wear

Thanks to the contactless operating principle, mechanical wear is not an issue.

Reed contact

A reed contact is a magnetically or electromagnetically operated switch. The pair of ferromagnetic contact studs are housed in a hermetically sealed glass tube filled with inert gas. Under the influence of a magnetic field, the contact paddles assume opposing polarity (north and south pole) and close when a sufficient force is applied. This procedure can be repeated millions of times even at extremely short time intervals.

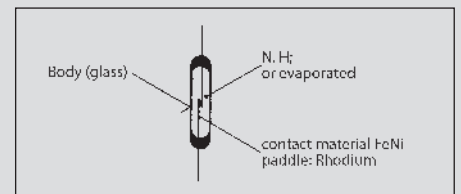

Design of a reed contact

BERNSTEIN float switches are equipped with barium ferrite magnets that are located in the float. Opening and closing of the contact studs is determined by the magnet in the float correspondingly approaching or moving away. The delivery range includes normally-closed contacts, normally-open contacts and changeover contacts.

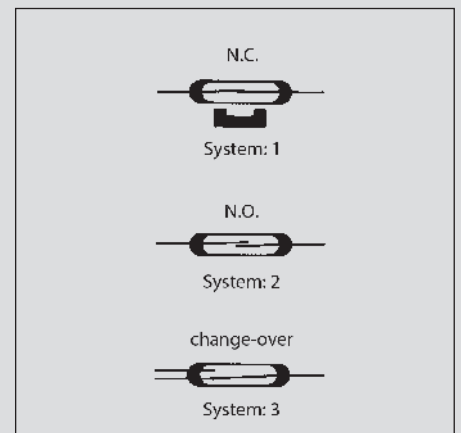

Versions of reed contacts

Switching distances (o/m/u)

The switching distances are defined with

- **o** = Top
- **m** = Middle
- **u** = Bottom

(please refer to Float Switch Enquiry and Order form on Page 134).

Switch length (x)

This is the length from the connection head up to the lower end of the tube.

x (max.) = 2000 mm

Maximum switching power

3 VA – 250 VA depending on type of reed contact (please refer to Page 130).

Immersion tube

Available in PVC, MS63, stainless 1.4571.

Maximum switching voltage

100 V – 250 V depending on type of reed contact (please refer to Page 130).

Switching point

The float magnet initiates a switching signal by magnetising the contact studs of the reed contact. Three switching points per switch are possible (more on request).

Switching path

This corresponds to the path, on which the contact remains active while the float is moving in the same direction.

Protection classes

Corresponding to their ID code, the switches are dustproof and waterproof in accordance with IP 65 or IP 67 (EN 60529, IEC 529).

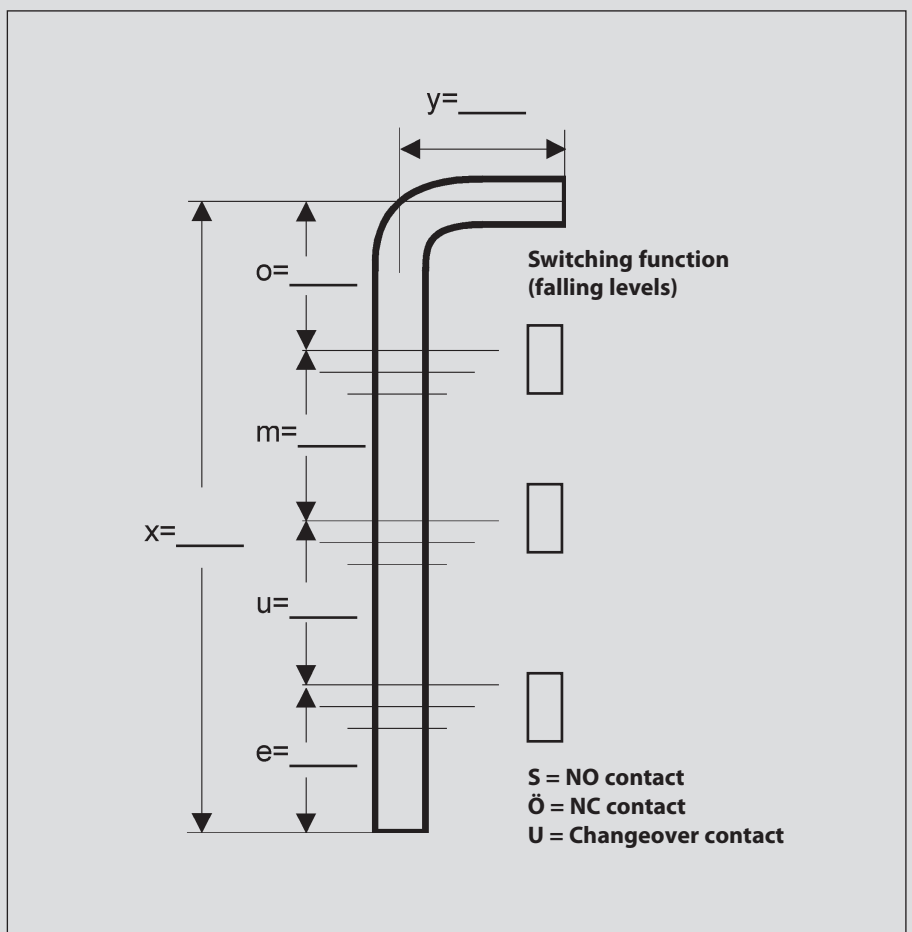
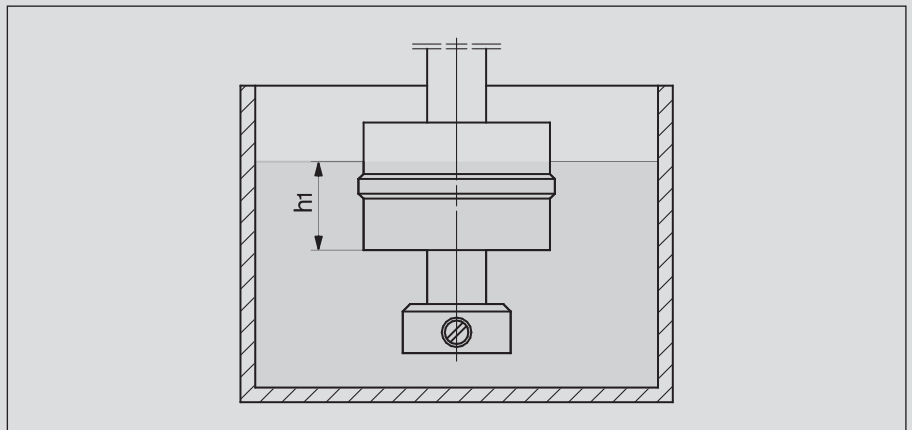

Float Switches

Guidelines for reed contact protection

The values for current, voltage and power specified in the catalogue apply only to purely resistive loads. Very often, however, these loads are exposed to inductive or capacitive components. In these cases it is advisable to protect the reed contacts against voltage and current peaks. Whilst it is not possible to recommend a safe contact protection concept that applies to all load ranges (each individual case will require its own evaluation), we would like to present general guidelines on how reed contacts may be connected to different loads in order to avoid premature failure.

1. Inductive loads

In DC applications, contact protection is relatively easy to realise with the aid of a free-wheeling diode connected in parallel to the load. The diode polarity must be selected so that it blocks when normal operating voltage is applied but will short-circuit the voltage induced after the switch is opened (voltage peaks can significantly exceed the operating voltage).

This can amount to a multiple of the operating voltage and initially cause a switching spark between the opening contact studs.

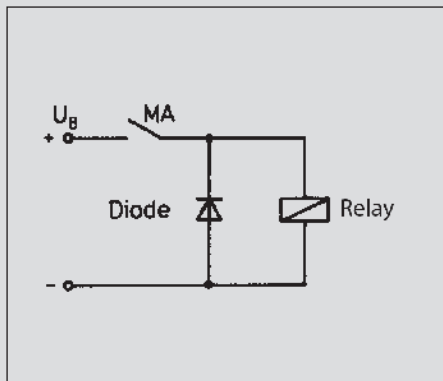

Suppression of voltage peaks with a free-wheeling diode

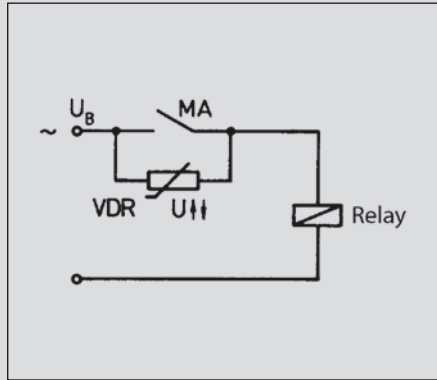

1) Voltage peaks induced by switching off inductive loads are suppressed by connecting a voltage-dependent resistor (VDR) in parallel to the reed contact.

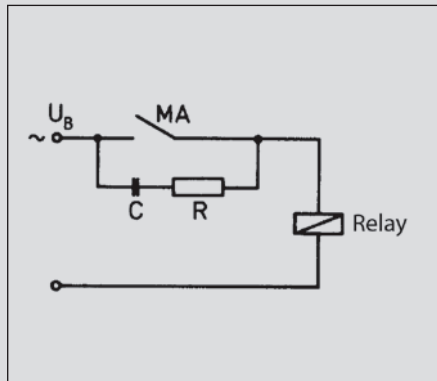

2) In AC voltage applications effective protection is achieved with a combination of a resistor and a capacitor (RC element).

Generally, the RC element is connected in parallel to the contact and therefore in series to the load (vice versa is also possible).

2. Capacitive loads

In contrast to inductive loads, an increase of making currents could occur in connection with capacitive loads and lamp loads that can damage and even weld contacts closed. When capacitors are switched (e.g. cable capacitance) a very high peak current occurs with its intensity depending on the capacitance and length of the cable leading to the switch.

A resistor connected in series to the contact will reduce this current. The size of the resistor is determined by the characteristics of the corresponding electric circuit. It should, however, be as large as possible to reduce the current to a permissible value, thus ensuring reliable contact protection.

Contact protection with resistors for limiting current:

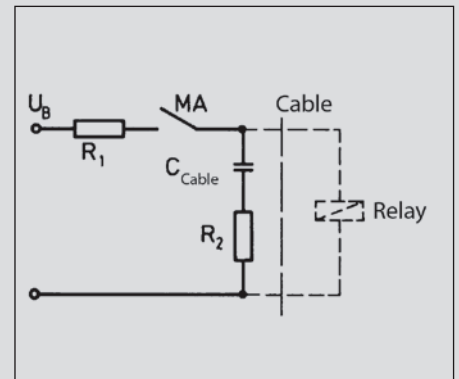

1) Capacitive load

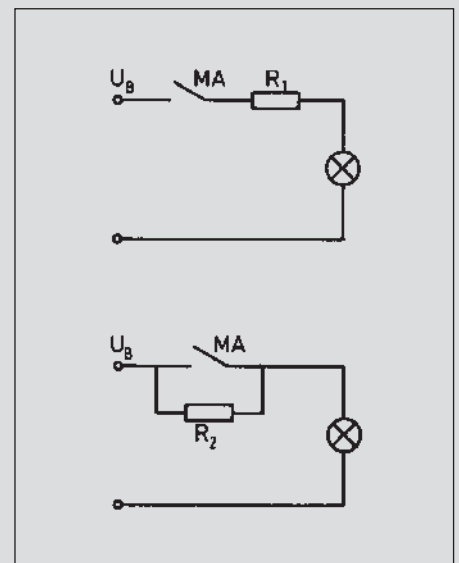

2) Lam load

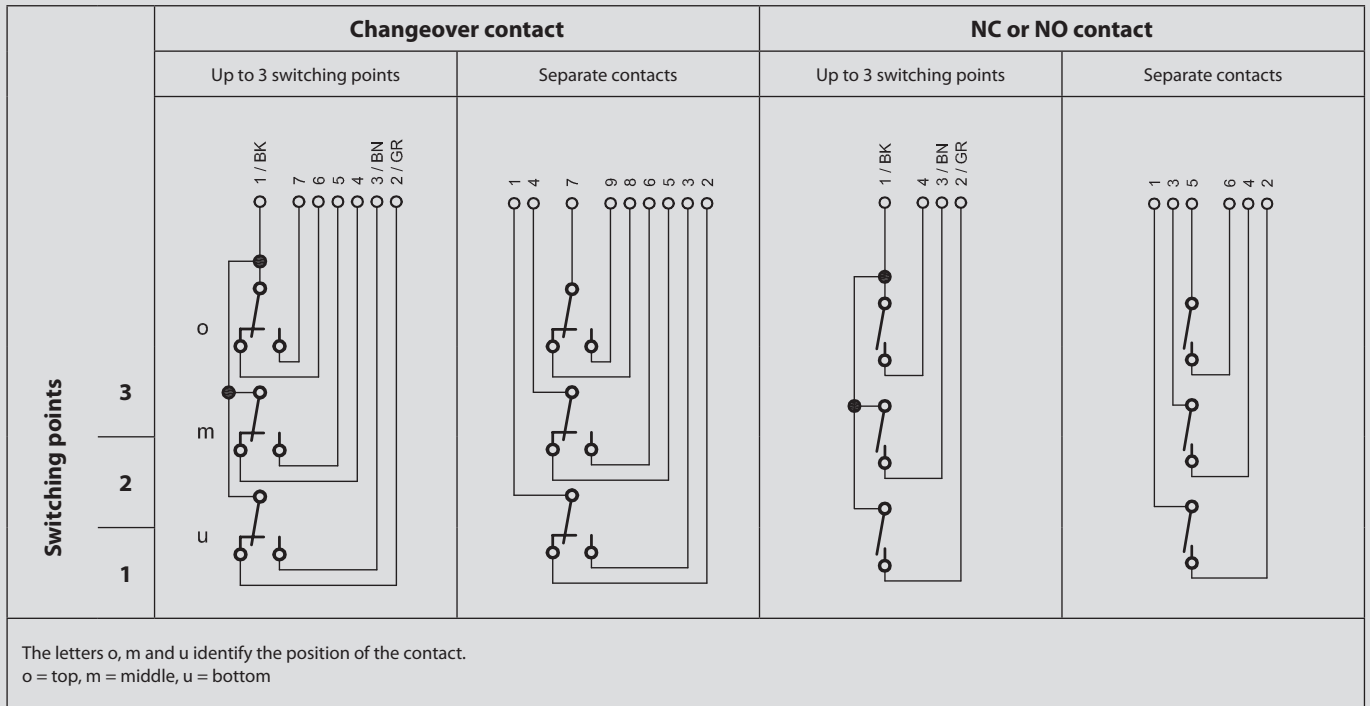
Wiring diagram

Standard float switches

Ordering example:
See Page 118

Position	1	2	3	4
Version	Magnetic float switch	Output type reed contact	Float switch – float combination	
Type	M	A		—

Min./max. dimensions

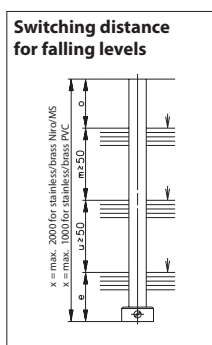

Float switch – float combination

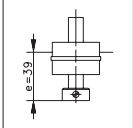
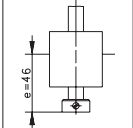
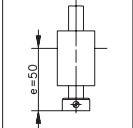
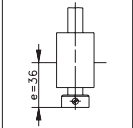
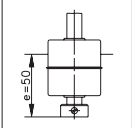
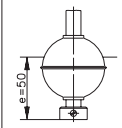

Float material	POM ø 40 x 27	PVC ø 42 x 44	PP ø 30 x 44	NBR ø 30 x 44	1.4571 ø 45 x 47	1.4571 ø 52
Connection head material						
Float switch material						

Half cable gland R3/8"



1.4571	1.4571	A	V	T	R	N	E
MS 59	MS63	M	L	C	S	P	F
PVC	PVC	K	D	I	U	—	—

Cable gland PG9



1.4571	1.4571	A	V	T	R	N	E
MS 58	MS63	M	L	C	S	P	F
PVC	PVC	K	D	I	U	—	—

ø 75 flange with connector



PC	1.4571	A	V	T	R	N	E
PC	MS63	M	L	C	S	P	F
PC	PVC	K	D	I	U	—	—

5	6	7	8	9	10	11	12	13
General design	Number of switching points	Switching function		Switching power	Connection head	Standard range		Special features (see Page 119)
7						S		

Number of switching points Switching function Switching power Connection head

↓ ↓ ↓ ↓

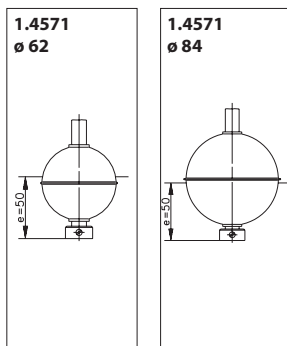

1 Switching point
2 Switching points
3 Switching points

1 NC contact
2 NO contact
3 Changeover contact
4 Mixed version (CO, NC, NO)

max. 0.5 A – 30 VA – 250 V
max. 1 A – 60 VA – 250 V
min. switching power = 3 VA

Straight type
Type in illustration in 1.4571 material. Slight dimensional variations may occur in PVC and brass versions.

ID letter for connection head

Elbow version
Type in illustration in 1.4571 material. Slight dimensional variations may occur in PVC versions.

ID letter for connection head

B	G	1/2/3	1/2/3/4	K	L	A
O	H	1/2/3	1/2/3/4	K	L	A
—	—	1/2/3	1/2/3/4	K	L	A

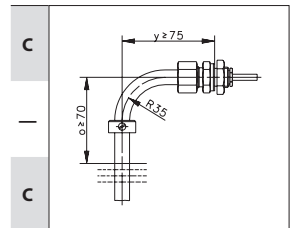
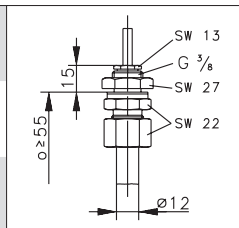

B	G	1/2/3	1/2/3/4	K	L	V
O	H	1/2/3	1/2/3/4	K	L	V
—	—	1/2/3	1/2/3/4	K	L	V

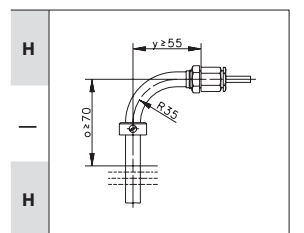
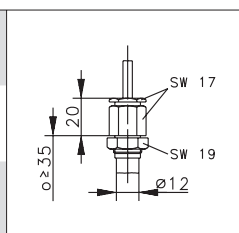

B	G	1/2/—	1/2/3/4	K	L	T
O	H	1/2/—	1/2/3/4	K	L	T
—	—	1/2/—	1/2/3/4	K	L	T

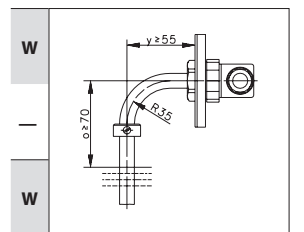
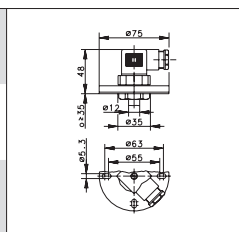

Standard float switches

Ordering example:
See Page 118

Position	1	2	3	4
Version	Magnetic float switch	Output type reed contact	Float switch – float combination	
Type	M	A		—

Min. / max. dimensions

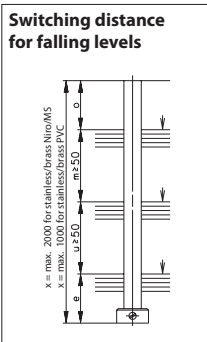

Float switch – float combination



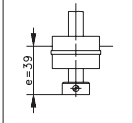
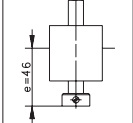
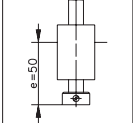
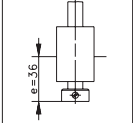
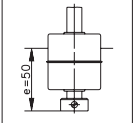
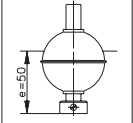



Float material	POM ø 40 x 27	PVC ø 42 x 44	PP ø 30 x 44	NBR ø 30 x 44	1.4571 ø 45 x 47	1.4571 ø 52
Connection head material						
Float switch material						



PC	1.4571	A	V	T	R	N	E
PC	MS63	M	L	C	S	P	F
PC	PVC	K	D	I	U	—	—



G-AI Si 12	1.4571	A	V	T	R	N	E
G-AI Si 12	MS63	M	L	C	S	P	F
G-AI Si 12	PVC	K	D	I	U	—	—

5	6	7	8	9	10	11	12	13
General design	Number of switching points	Switching function		Switching power	Connection head	Standard range		Special features (see Page 119)
7						S		

Number of switching points Switching function Switching power Connection head

↓ ↓ ↓ ↓

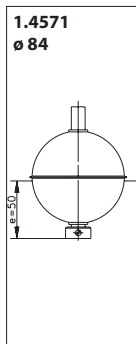
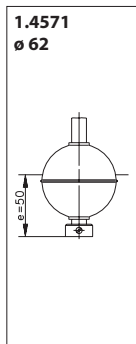

1 Switching point
2 Switching points
3 Switching points

1 NC contact
2 NO contact
3 Changeover contact
4 Mixed version (CO, NC, NO)

max. 0.5 A – 30 VA – 250 V
max. 1 A – 60 VA – 250 V
min. switching power = 3 VA

ID letter for connection head

Straight type
Type in illustration in 1.4571 material. Slight dimensional variations may occur in PVC and brass versions.

ID letter for connection head

Elbow version
Type in illustration in 1.4571 material. Slight dimensional variations may occur in PVC versions.

B	G	1/2	1/2/3/4	K	L	TO
O	H	1/2	1/2/3/4	K	L	TO
—	—	1/2	1/2/3/4	K	L	TO

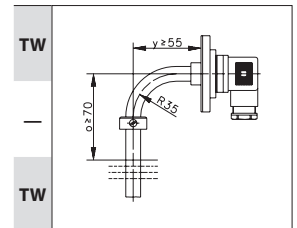
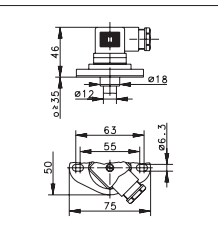

B	G	1/2/3	1/2/3/4	K	L	S
O	H	1/2/3	1/2/3/4	K	L	S
—	—	1/2/3	1/2/3/4	K	L	S

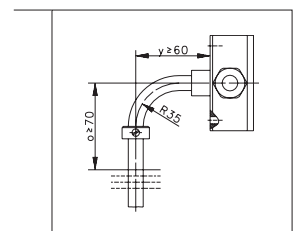
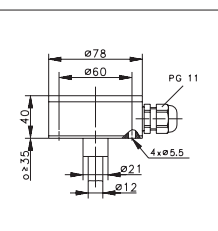

Standard float switches

Ordering example:
See Page 118

Position	1	2	3	4
Version	Magnetic float switch	Output type reed contact	Float switch – float combination	
Type	M	A		—

Min. / max. dimensions



Float switch – float combination



Switching distance for falling levels

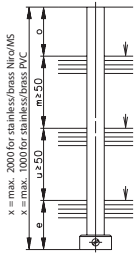

Float material

Connection head material

Float switch material

POM
ø 40 x 27

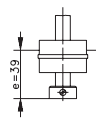

PVC
ø 42 x 44

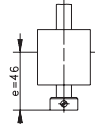

PP
ø 30 x 44

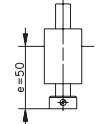

NBR
ø 30 x 44

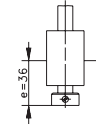

1.4571
ø 45 x 47

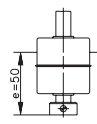

1.4571
ø 52

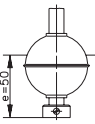

Flange enclosure DN50
ø 165



1.4571/ G-Al Si 12	1.4571	A	V	T	R	N	E
-----------------------	--------	---	---	---	---	---	---

PVC/ G-Al Si 12	PVC	K	D	I	U	—	—
--------------------	-----	---	---	---	---	---	---

Flange enclosure DN65
ø 185

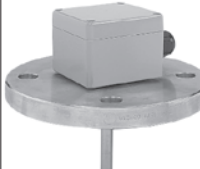

1.4571/ G-Al Si 12	1.4571	A	V	T	R	N	E
-----------------------	--------	---	---	---	---	---	---

PVC/ G-Al Si 12	PVC	K	D	I	U	—	—
--------------------	-----	---	---	---	---	---	---

Tank cable gland R1,5"



G-Al Si 12	1.4571	A	V	T	R	N	E
------------	--------	---	---	---	---	---	---

PVC/ Polyester	PVC	K	D	I	U	—	—
-------------------	-----	---	---	---	---	---	---

Standard float switches

Ordering example: 
MAK-721 KR2S

Position	1	2	3	4
Version	Magnetic float switch	Output type reed contact	Float switch – float combination	
Type	M	A		–

Min. / max. dimensions



Float switch – float combination

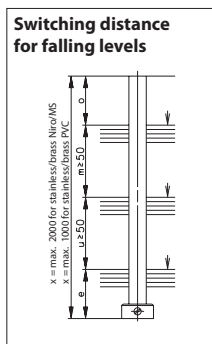

Float material	
Connection head material	Float switch material

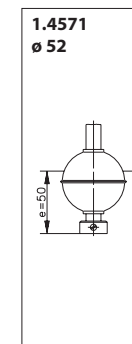
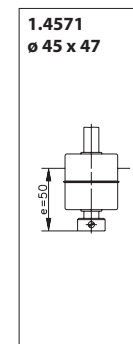
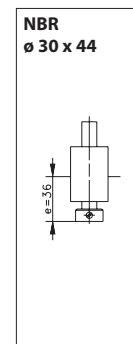
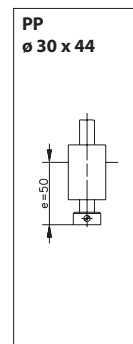
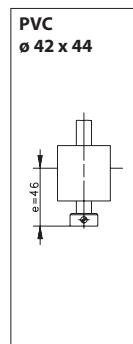
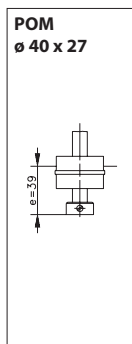

1.4571/ G-Al Si 12	1.4571	A	V	T	R	N	E
PVC/ Polyester	PVC		D	I	U	–	–

With specification $o = \text{_____}$; $u = \text{_____}$ (see Order form on Page 134)

Miniature float switches

Ordering example:
See Page 118

Position	1	2	3
Version	Miniature float switches	Float	
Type	MS		—

Min. / max. dimensions



Float



Switching distance
for falling levels

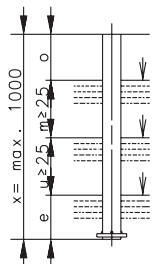

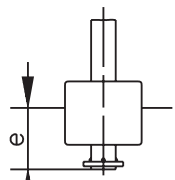
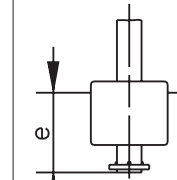
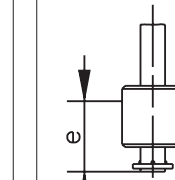
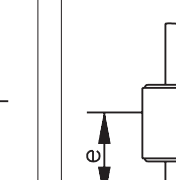
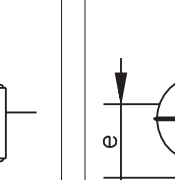
PP $\phi 25 \times 21$  e = 20 (NC contact) e = 17 (NO contact)	PVC $\phi 25 \times 21$  e = 26 (NC contact) e = 23 (NO contact)	NBR $\phi 20 \times 20$  e = 23 (NC contact) e = 23 (NO contact)	NBR $\phi 23 \times 25$  e = 28 (NC contact) e = 22 (NO contact)	1.4571 $\phi 30$  e = 24 (NC contact) e = 23 (NO contact)
--	---	---	--	--

Connection thread
R1/8"



K1	K2	K3	K4	N1
K1	K2	K3	K4	N1
K1	—	K3	K4	—
—	K2	K3	K4	—

Connection thread
R3/8"







K1	K2	K3	K4	N1
K1	K2	K3	K4	N1
K1	—	K3	K4	—
—	K2	K3	K4	—

Connection thread
R3/8" with connector



K1	K2	K3	K4	N1
K1	K2	K3	K4	N1
K1	—	K3	K4	—
—	K2	K3	K4	—

4	5	6	7	8	9	10
Enclosure material		Connection head		Switching function		Special features (see Page 119)
	—		—			

Enclosure material

Connection head

Switching function



Ni (stainless) = 1.4571
 MS (brass) = MS63
 PP = Polypropylene
 PVC = Polyvinyl chloride

Version

S = NO contact (250 V–0.5 A–10 VA)
 max. = 10 VA
 O = NC contact (100 V; 0.3 A; 3 VA)
 U = Changeover contact
 (100 V; 0.3 A; 3 VA)

X = max. overall length (mm)
 Max. number of switching points
 Cable length (m)

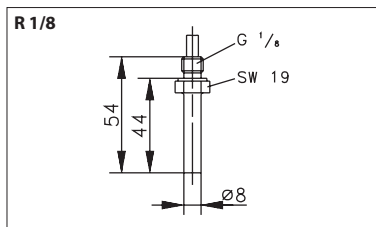
Ni
 MS
 PP
 PVC



S	O	U	1000	3	1
S	O	U	1000	3	1
S	O	U	40,5	1	1
S	O	U	500	3	1

Ni
 MS
 PP
 PVC

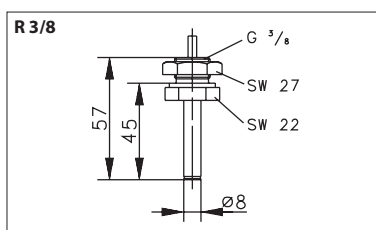

S	O	U	1000	3	1
S	O	U	1000	3	1
S	O	U	40,5	1	1
S	O	U	500	3	1

Ni
 MS
 PP
 PVC

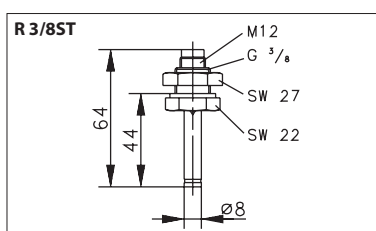

S	O	U	1000	3	—
S	O	U	1000	3	—
PP			40,5	1	—
PVC			500	3	—

Miniature float switches

Ordering example:
See Page 118

Position	1	2	3
Version	Miniature float switches	Float	
Type	MS		—

Min. / max. dimensions



Float



Switching distance
for falling levels

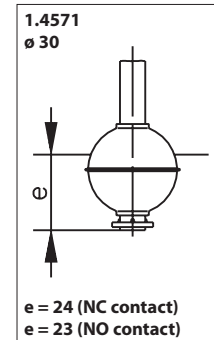
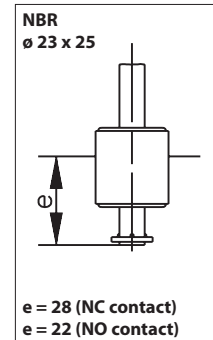
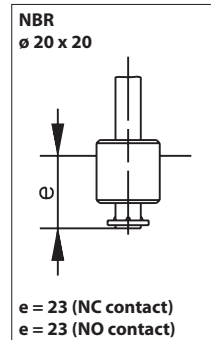
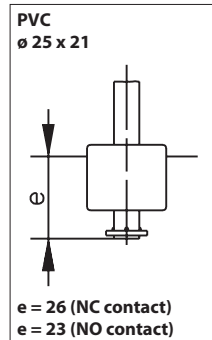
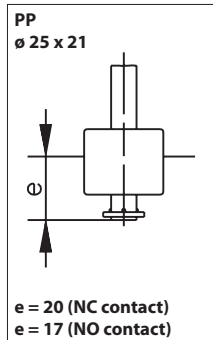
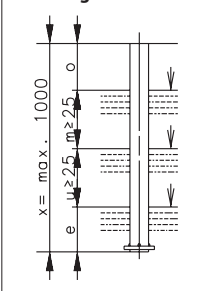

Connection thread PG7







K1	K2	K3	K4	N1
K1	K2	K3	K4	N1
K1	—	K3	K4	—
—	K2	K3	K4	—

MSKS-PA-FL36-05



—	—	—	—	—
---	---	---	---	---

4	5	6	7	8	9	10
Enclosure material		Connection head		Switching function		Special features (see Page 119)
	—		—			

Enclosure material



Connection head



Switching function



Ni (stainless) = 1.4571
 MS (brass) = MS63
 PP = Polypropylene
 PVC = Polyvinyl chloride

Version

S = NO contact (250 V–0.5 A–10 VA)
 max. = 10 VA
 O = NC contact (100 V; 0.3 A; 3 VA)
 U = Changeover contact
 (100 V; 0.3 A; 3 VA)

X = max. overall length (mm)
 Max. number of switching points
 Cable length (m)

Ni
 MS
 PP
 PVC

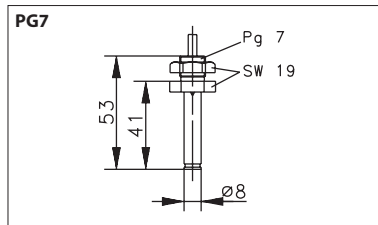

S	O	U	1000	3	1
S	O	U	1000	3	1
S	O	U	40,5	1	1
S	O	U	500	3	1

PA12
 (Enclosure & float)

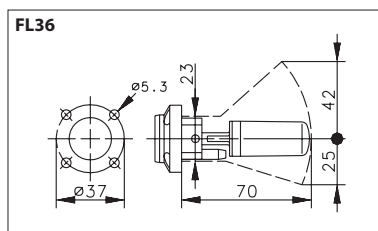

S O —
 (with 1 m cable)

For lateral mounting

Adjustable float switches

Ordering example:
See Page 118

Position	1	2	3	4
Version	Magnetic float switch	Output type reed contact	Float switch – float combination	
Type	M	A		—

Min./max. dimensions

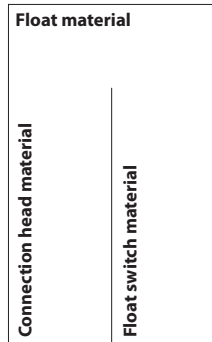
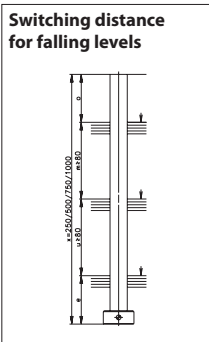

Float switch – float combination

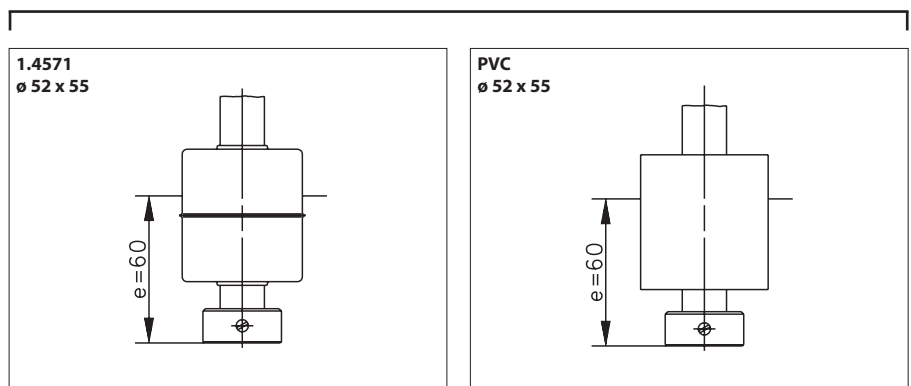



1.4571/ G-Al Si 12	1.4571	N	V
PVC/ Polyester	PVC	—	D



1.4571/ G-Al Si 12	1.4571	N	V
PVC/ Polyester	PVC	—	D



G-Al Si 12	1.4571	N	V
PVC/ Polyester	PVC	—	D

5	6	7	8
Adjustable	Connection head		Length
VST		/	

Important! Please order switching devices without switching modules separately!

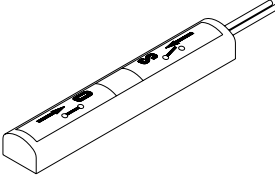
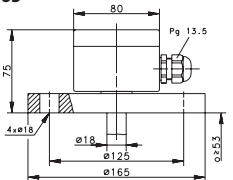
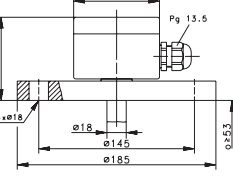
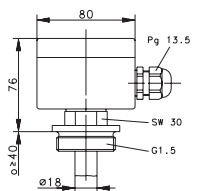
Connection head	Length	Switching module	Max. number of switching modules / switching devices		
↓	↓	↓			
Version	Other lengths (mm) on request	 NC / NO contact Bistable Changeover contact	NC / NO contact Lengths 250 mm 500 mm 750 mm 1000 mm	Changeover contact Lengths 250 mm 500 mm 750 mm 1000 mm	
FL165 	250 / 500 / 750 / 1000	4910007069	4916007075	2 / 3 / 4 / 4	2 / 3 / 3 / 3
	250 / 500 / 750 / 1000	4910007069	4916007075	2 / 3 / 4 / 4	2 / 3 / 3 / 3
	250 / 500 / 750 / 1000	4910007069	4916007075	2 / 3 / 4 / 4	2 / 3 / 3 / 3
FL185 	250 / 500 / 750 / 1000	4910007069	4916007075	2 / 3 / 4 / 4	2 / 3 / 3 / 3
	250 / 500 / 750 / 1000	4910007069	4916007075	2 / 3 / 4 / 4	2 / 3 / 3 / 3
	250 / 500 / 750 / 1000	4910007069	4916007075	2 / 3 / 4 / 4	2 / 3 / 3 / 3
R1,5 	250 / 500 / 750 / 1000	4910007069	4916007075	2 / 3 / 4 / 4	2 / 3 / 3 / 3
	250 / 500 / 750 / 1000	4910007069	4916007075	2 / 3 / 4 / 4	2 / 3 / 3 / 3
	250 / 500 / 750 / 1000	4910007069	4916007075	2 / 3 / 4 / 4	2 / 3 / 3 / 3

Adjustable float switches

Ordering example:
See Page 118

Position	1	2	3	4
Version	Magnetic float switch	Output type reed contact	Float switch – float combination	
Type	M	A		—

Min. / max. dimensions

Float switch – float combination



Switching distance for falling levels

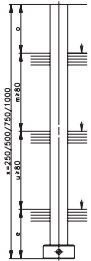

Float material

Connection head material

Float switch material

1.4571
ø 52 x 55

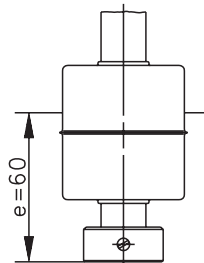

PVC
ø 52 x 55

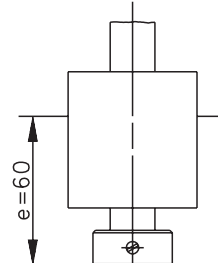

Tank cable gland R2"



1.4571/
G-Al Si 12

1.4571

N



V

PVC/
Polyester

PVC

—

D

5	6	7	8
Adjustable	Connection head		Length
VST		/	

Important! Please order switching devices without switching modules separately!

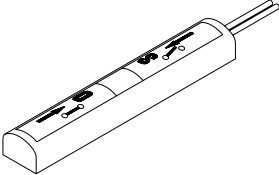
Connection head	Length	Switching module	Max. number of switching modules / switching devices	
↓	↓	↓	↓	
Version	Other lengths (mm) on request	 NC / NO contact Bistable Changeover contact	NC / NO contact Lengths 250 mm 500 mm 750 mm 1000 mm	Changeover contact Lengths 250 mm 500 mm 750 mm 1000 mm

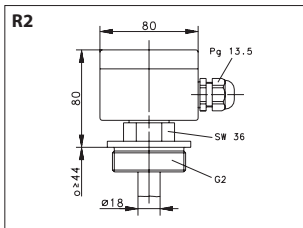

250 / 500 / 750 / 1000	4910007069	4916007075	2 / 3 / 4 / 4	2 / 3 / 3 / 3
250 / 500 / 750 / 1000	4910007069	4916007075	2 / 3 / 4 / 4	2 / 3 / 3 / 3
250 / 500 / 750 / 1000	4910007069	4916007075	2 / 3 / 4 / 4	2 / 3 / 3 / 3

Range of Floats

Floats Standard Float Switches

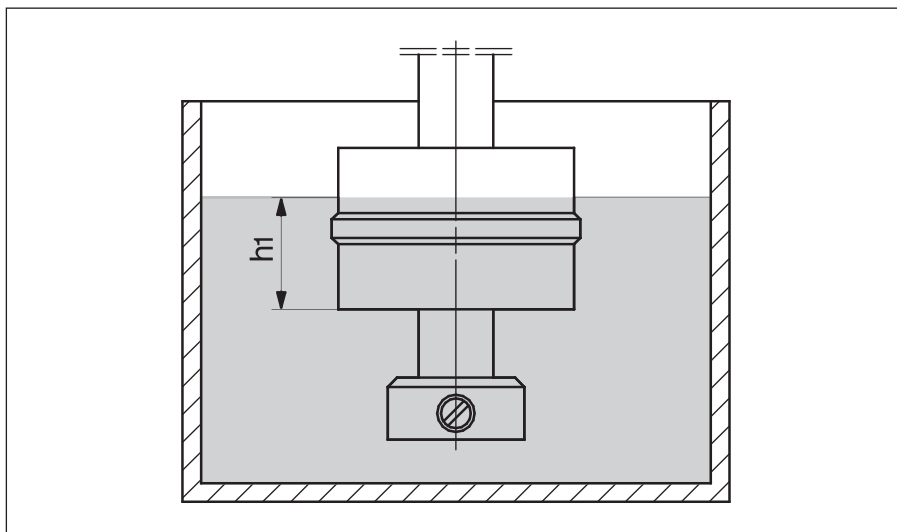

ID letter	A/M/K
Dimensions (mm)	Ø 40 x 27
Material	POM

Immersion depth h1 (mm)	Density ρ (g/cm ³)
18	1
20	0.9
22,5	0.8
26	0.7

Art. No.: 4945206009



ID letter	T/C/I
Dimensions (mm)	Ø 30 x 44
Material	PP

Immersion depth h1 (mm)	Density ρ (g/cm ³)
27,5	1
30,5	0.9
34,5	0.8
39,5	0.7

Art. No.: 4945203019



ID letter	R/S/U
Dimensions (mm)	Ø 30 x 44
Material	NBR

Immersion depth h1 (mm)	Density ρ (g/cm ³)
19,5	1
22	0.9
24,5	0.8
28	0.7

Art. No.: 4945203031



ID letter	V/L/D
Dimensions (mm)	Ø 42 x 44
Material	PVC

Immersion depth h1 (mm)	Density ρ (g/cm ³)
25	1
27,5	0.9
30,5	0.8
35	0.7

Art. No.: 4945215029



ID letter	N/P
Dimensions (mm)	Ø 44 x 45
Material	1.4571

Immersion depth h1 (mm)	Density ρ (g/cm ³)
32	1
35	0.9
39	0.8
45	0.7

Art. No.: 4942104002



ID letter	E/F
Dimensions (mm)	Ø 52
Material	1.4571

Immersion depth h1 (mm)	Density ρ (g/cm ³)
32	1
34	0.9
37	0.8
43	0.7

Art. No.: 4942105003



ID letter	B/O
Dimensions (mm)	Ø 62
Material	1.4571

Immersion depth h1 (mm)	Density ρ (g/cm ³)
33	1
35	0.9
38	0.8
42	0.7

Art. No.: 4942102001



ID letter	G/H
Dimensions (mm)	Ø 84
Material	1.4571

Immersion depth h1 (mm)	Density ρ (g/cm ³)
33	1
35	0.9
38	0.8
42	0.7

Art. No.: 4942101004



Floats

Adjustable Float Switches

ID letter	V/L/D
Dimensions (mm)	Ø 52 x 55
Material	PVC
Immersion depth h1 (mm)	Density ρ (g/cm ³)
29	1
32	0.9
36	0.8
42	0.7
Art. No.: 4945216032	



ID letter	N/P
Dimensions (mm)	Ø 52 x 55
Material	1.4571
Immersion depth h1 (mm)	Density ρ (g/cm ³)
33	1
36	0.9
40,5	0.8
46	0.7
Art. No.: 4942299023	



Floats

Miniature Float Switches

ID letter	K1
Dimensions (mm)	Ø 25 x 21
Material	PP
Immersion depth h1 (mm)	Density ρ (g/cm ³)
12	1
13	0.9
14,5	0.8
16,5	0.7
Art. No.: 4945207021	



ID letter	K2
Dimensions (mm)	Ø 25 x 21
Material	PVC
Immersion depth h1 (mm)	Density ρ (g/cm ³)
15	1
16	0.9
18,5	0.8
-	0.7
Art. No.: 4945207022	



ID letter	K4
Dimensions (mm)	Ø 23 x 25
Material	NBR
Immersion depth h1 (mm)	Density ρ (g/cm ³)
16	1
17,5	0.9
19,5	0.8
22	0.7
Art. No.: 4945211024	



ID letter	K3
Dimensions (mm)	Ø 20 x 20
Material	NBR
Immersion depth h1 (mm)	Density ρ (g/cm ³)
15	1
17	0.9
-	0.8
-	0.7
Art. No.: 4945210020	



ID letter	N1
Dimensions (mm)	Ø 30
Material	1.4571
Immersion depth h1 (mm)	Density ρ (g/cm ³)
18	1
19	0.9
21	0.8
24	0.7
Art. No.: 4942109018	



Technical data

Standard Float switches



Electrical data

Switching function
Contact ID letter
Switching voltage (max)
Switching current (max)
Switching power (max)

Changeover / NC / NO contacts	Changeover / NC / NO contacts
K	L (min. Switching power 3 VA)
250 V AC/DC	250 V AC/DC
0.5 A	1 A
30 VA	60 VA

Mechanical data

Container connection options

Flange enclosure RD 77 mm	Flange enclosure RD 77 mm
Flange enclosure RD 165 mm	Flange enclosure RD 165 mm
Flange enclosure RD 185 mm	Flange enclosure RD 185 mm
Cable gland PG9	Cable gland PG9
Cable gland R3/8"	Cable gland R3/8"
Cable gland R1/5" with connector DIN 43650	Cable gland R1/5" with connector DIN 43650
Oval flange 75 x 50 mm with connector DIN 43650	Oval flange 75 x 50 mm with connector DIN 43650

Float switch material

Stainless steel 1.4571	Stainless steel 1.4571
Brass MS63	Brass MS63
PVC	PVC

Float variants

A/M/K Cylinder float	RD 40 x 27 mm (POM)	A/M/K Cylinder float	RD 40 x 27 mm (POM)
T/C/I Cylinder float	RD 30 x 44 mm (PP)	T/C/I Cylinder float	RD 30 x 44 mm (PP)
V/D Cylinder float	RD 42 x 44 mm (NBR)	V/D Cylinder float	RD 42 x 44 mm (NBR)
R/S Cylinder float	RD 30 x 44 mm (NBR)	R/S Cylinder float	RD 30 x 44 mm (NBR)
N/P Cylinder float	RD 44 x 45 mm (stainless steel)	N/P Cylinder float	RD 44 x 45 mm (stainless steel)
E/F Ball float	RD 52 mm (stainless steel)	E/F Ball float	RD 52 mm (stainless steel)
B/O Ball float	RD 62 mm (stainless steel)	B/O Ball float	RD 62 mm (stainless steel)
G/H Ball float	RD 84 mm (stainless steel)	G/H Ball float	RD 84 mm (stainless steel)

Ambient conditions

Protection class (DIN 40050)
Temperature range
Pressure

IP 65 (up to IP 68 on request)	IP 65 (up to IP 68 on request)
-5 °C to +70 °C (from -30 °C to +150 °C on request)	-5 °C to +70 °C (from -30 °C to +150 °C on request)
5 bar (up to 25 bar on request)	5 bar (up to 25 bar on request)

Miniature Float Switches



Electrical data

Switching function	Changeover / NC contacts	Changeover / NC / NO contacts
Contact ID letter	B	X
Switching voltage (max)	250 V AC/DC	100 V AC/DC
Switching current (max)	0.5 A	0.3 A
Switching power (max)	10 VA	3 VA

Mechanical data

Container connection options	Cable gland PG7	Cable gland PG7
	Cable gland R1/8"	Cable gland R1/8"
	Cable gland R3/8"	Cable gland R3/8"
	Cable gland R3/8" with connector	Cable gland R3/8" with connector

Float switch material	Stainless steel 1.4571	Stainless steel 1.4571
	PP	PP
	PVC	PVC
	Brass MS63	Brass MS63

Float variants	K1	Cylinder float	RD 25 x 20 mm (PP)	K1	Cylinder float	RD 25 x 20 mm (PP)
	K2	Cylinder float	RD 25 x 20 mm (PVC)	K2	Cylinder float	RD 25 x 20 mm (PVC)
	K3	Cylinder float	RD 20 x 20 mm (NBR)	K3	Cylinder float	RD 20 x 20 mm (NBR)
	K4	Cylinder float	RD 23 x 25 mm (NBR)	K4	Cylinder float	RD 23 x 25 mm (NBR)
	N1	Ball float	RD 30 mm (stainless steel)	N1	Ball float	RD 30 mm (stainless steel)

Ambient conditions

Protection class (DIN 40050)	IP 65 (up to IP 68 on request)	IP 65 (up to IP 68 on request)
Temperature range	-5 °C to +70 °C (from -30 °C to +150 °C on request)	-5 °C to +70 °C (from -30 °C to +150 °C on request)
Pressure	5 bar (up to 15 bar on request)	5 bar (up to 15 bar on request)

Adjustable Float Switches



Electrical data

Contact ID letter
Switching module, type designation
Article number
Switching function
Switching voltage (max)
Switching current (max)
Switching power (max)

P
REEDK. KPL. F. MA
4910007069
NC / NO contact (bi)
250 V AC / DC
5 A
250 VA

L
REEDK. KPL. F. MA
4916007075
Changeover contact (bi)
250 V AC / DC
1 A
60 VA

Mechanical data

Container connection options

Flange DN 50 (PVC/stainless steel)
Flange DN 65 (PVC/stainless steel)
Cable gland R1.5" (PVC/stainless steel)
Cable gland R2" (PVC/stainless steel)

Flange DN 50 (PVC/stainless steel)
Flange DN 65 (PVC/stainless steel)
Cable gland R1.5" (PVC/stainless steel)
Cable gland R2" (PVC/stainless steel)

Float switch material

Stainless steel 1.4571
Brass MS63
PVC

Stainless steel 1.4571
Brass MS63
PVC

Float variants

N/P Cylinder float RD 52 x 55 mm (stainless steel)
V/D/L Cylinder float RD 52 x 55 mm (PVC)

N/P Cylinder float RD 52 x 55 mm (stainless steel)
V/D/L Cylinder float RD 52 x 55 mm (PVC)

Ambient conditions

Protection class (DIN 40050)
Temperature range
Pressure

IP 65 (up to IP 68 on request)
-5 °C to +70 °C (from -30 °C to +150 °C on request)
5 bar (up to 15 bar on request)

IP 65 (up to IP 68 on request)
-5 °C to +70 °C (from -30 °C to +150 °C on request)
5 bar (up to 15 bar on request)

Chemical Resistance

Float switch materials at +20 °C

Chemical substance	Conc. in %	POM	PP	NBR	PVC	Brass MS63 1.4571	
Acetone	100	+	+	U	U	+	+
Aluminium sulphate	10	/	+	+	+	U	+
Aluminium chloride	10	/	+	+	+	U	+
Formic acid	85	+	+	U	+	U	+
Ammonia	10	+	+	U	O	U	+
Aniline	100	/	+	U	U	O	+
Ethyl acetate	100	O	O	U	U	+	+
Ethyl ether	100	+	+	U	/	+	+
Ethylene chloride	100	/	U	U	U	/	+
Benzine	100	+	U	+	+	+	+
Benzene	100	+	U	O	U	+	+
Boric acid	10	/	+	+	+	+	+
Butyl acetate	100	+	O	U	U	/	+
Calcium chloride	10	+	+	+	+	U	+
Chlorobenzene	100	+	+	U	U	/	+
Chlorine water	-	/	+	U	O	U	+
Chloroform	100	/	U	U	U	+	+
Chromic acid	10	O	+	U	+	U	+
Ferrous chloride	10	O	+	+	+	U	U
Acetic acid	10	+	+	U	+	U	+
Acetic acid	80	O	+	U	+	U	+
Formaldehyde	20	+	+	+	+	O	+
Glycerine	90	+	+	+	+	+	+
Urea	10	/	+	+	+	/	+
Iodine	-	/	+	+	U	/	+
Potassium bichromate	5	/	+	O	+	U	+
Potassium nitrate	10	/	+	+	+	/	+
Potassium permanganate	1	+	+	O	+	/	+
Copper sulphate	10	/	/	+	+	U	+
Magnesium chloride	10	/	+	+	+	U	+
Methylene chloride	100	U	U	U	O	/	+
Lactic acid	10	+	+	O	+	O	+
Mineral oil	100	+	+	+	+	+	+
Sodium bisulphite	10	/	+	U	O	U	+
Sodium carbonate	10	+	+	+	+	O	+
Sodium chloride	10	+	+	+	+	O	+
Sodium sulphate	10	/	+	+	+	+	+
Oxalic acid	40	/	O	U	+	O	O
Phenol, aqueous	10	U	+	U	+	/	+
Phosphoric acid	10	+	+	O	+	U	+
Mercury	100	/	+	+	+	U	+
Mercuric chloride	5	/	+	+	O	U	+
Nitric acid	65	U	U	U	+	U	+
Nitric acid	10	U	O	U	+	U	+
Hydrochloric acid	10	U	+	U	+	U	U
Hydrochloric acid	2	U	+	U	+	U	U
Carbon disulphide	100	+	U	U	U	+	+
Sulphuric acid	10	+	+	+	+	U	+
Sulphuric acid	98	U	O	U	O	U	+
Hydrogen sulphide	2	/	+	+	+	O	+
Soap solution	1	+	+	+	+	+	+
Carbon tetrachloride	100	+	U	U	O	+	+
Trichloroethylene	100	O	O	U	U	O	+
Wine	-	/	+	+	+	O	+
Zinc chloride	10	/	+	+	+	U	+

+ = Resistant

The material remains fully resistant to the medium or is minimally affected. The effect of pressure and temperature changes on the materials must be taken into account.

O = Conditionally resistant

The material is affected by the medium; sealing materials swell. Application may be possible if concentration, pressure, temperature, service life or other influencing factors are restricted.

U = Non-resistant

The material may not be used in the specified medium or at the given temperature unless under very clearly defined preconditions.

/ = No data available

Enquiry and Order Form Float Switches

Enquiry

Date: _____

Order

Receiver

BERNSTEIN AG
Tieloser Weg 6
D-32457 Porta Westfalica

Telephone: +49-(0)571/793-0
Fax: +49-(0)571/793-555
info@de.bernstein.eu

Sender

Company: _____

Customer No.: _____

Contact: _____

Department: _____

Street: _____

Town: _____

Telephone: _____

Fax: _____

E-mail: _____

Operational environment

Medium: _____ Temperature: from _____ °C to _____ °C

Pressure: min. _____ bar max. _____ bar

One-off Batch order Sample

Batch size: _____ pcs.

Annual quantity: _____ pcs.

Electrical data

Voltage: _____ V AC DC Current: _____ A

Power: min. _____ VA max. _____ VA

Technical data

Cable length*: _____ m Separate contacts

Mounting: From top From bottom From side

*Standard 1 m

Type

1	2	3	4	5	6	7	8	9	10	11	12	13		

Special features

Remarks

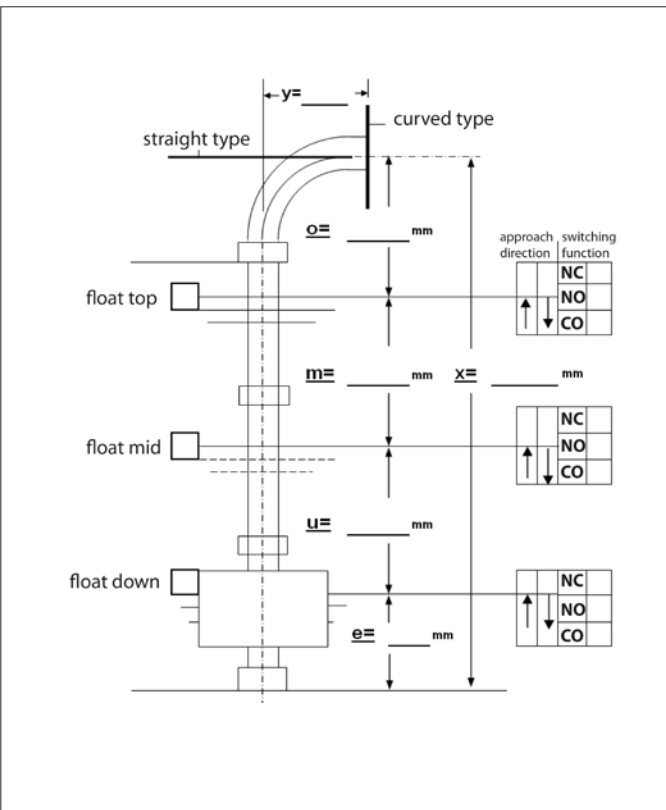

Magnets

1. Hard ferrite magnets

Barium and strontium hard ferrites are economically priced, reliable components that are also widely used in automation, control and measurement applications. When operated in high temperature ranges, the specified switching distance will decrease by a factor of 0.2 % per 1 °C.

Chemical properties:

Ferrite magnets are oxide ceramics. They are made of approx. 80 % iron oxide and 20 % barium oxide or strontium oxide. The magnets are resistant to a large number of chemicals, including solvents, caustic solutions and weak acids. If strong organic and inorganic acids, e.g. hydrochloric, sulphuric and hydrofluoric acid, are used, their resistance will basically be determined by the temperature, concentration and reaction time of the medium. In general, the resistance should first be determined by means of longterm tests.

Mechanical properties:

Due to their ceramic characteristic, ferrites are brittle and sensitive to shock and bending loads.

2. Rare-earth magnets

Permanent magnets made from samarium cobalt and neodymium iron boron are high performance and high quality components that are widely used in drive and control engineering. When operated in high temperature ranges, the specified switching distance will decrease by a factor of 0.02 % per 1 °C.

Chemical properties:

All rare-earth magnets are metallic materials and show the corresponding characteristics associated with these materials, e.g. the polished shine immediately after being machined. The magnets are surface-treated (e.g. nickel coating) to protect them from environmental influences.

Mechanical properties:

Minor chips may occur if rare-earth magnets are subjected to impact stress. They respond very sensitively to vibrations and may become demagnetised.

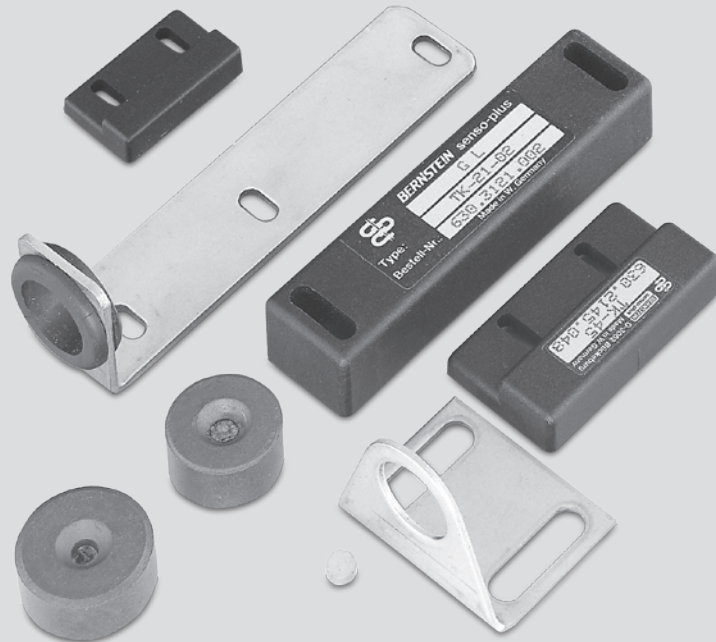

3. Plastic-bound magnets

Plastic-bound permanent magnets have an attractive price-performance ratio and thanks to the way they are formed they can be produced with complex geometries.

Injection-moulded magnets are typical composite materials. The magnetic powder is embedded in thermoplastic materials (polyamides). One of the main advantages of plastic-bound magnets is that they can be formed into a diverse range of shapes.

Chemical properties:

Surface corrosion can rarely be found on plastic bound magnets. For this reason, they can be used in most fields of application without additional coating.

Mechanical properties:

Plastic-bound magnets can be subjected to buckling and bending without breaking or chipping.

Use in potentially explosive atmospheres

Magnets must not be used in potentially explosive atmospheres as they can cause sparks. Grinding dust and chips from rare-earth magnets are self-igniting and burn off at high temperatures. They should therefore only be machined using ample water and never in dry conditions since even dried grinding dust can ignite.

Strong magnetic fields

Strong magnetic fields can interfere with or even damage electronic or mechanical equipment. This includes cardiac pacemakers. Appropriate safety distances are specified in the corresponding manuals or may be requested from the manufacturers.

Radioactive radiation

Permanent magnets must not be exposed to longterm radioactive radiation otherwise they may lose their magnetism.

Effects on persons

There are no known side-effects caused by touching magnet materials.

Magnet shapes

Rectangular, circular and cylindrical magnets are the most common shapes of permanent magnets manufactured in a press-shaping process. In addition to these standard geometries, permanent magnets may be manufactured in many other shapes. The shape should preferably be defined during the pressing process since subsequent shaping can only be performed using complex diamond tools. Holes and openings can only be made in the pressing direction.

Directions of magnetisation

The term preferred direction refers to the alignment of the magnetic crystals in a certain direction. The magnet achieves its highest magnetic values in this preferred direction and must therefore be magnetised in this direction.

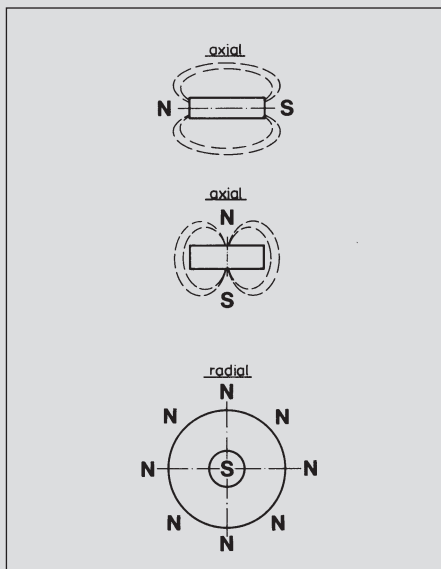

The preferred direction is achieved by subjecting the magnetic powder to a strong external magnetic field (coil) during the pressing process. As magnets have no preferred direction, the magnetisation direction and type can be freely selected.





Mounting a magnetic switch system on ferromagnetic materials

The nominal distance may be reduced when magnetic limit switches and their actuating magnets are mounted on magnetisable material (Fe, etc.). To ensure trouble-free operation, a minimum gap of 15 mm between the magnetic switch and any material that can be magnetised should be maintained as a reference value. The same applies to the actuating magnets.



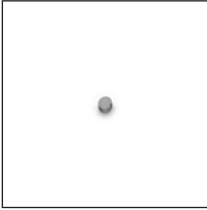
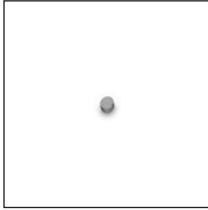
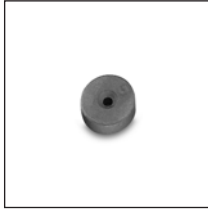
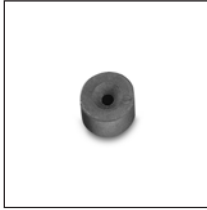
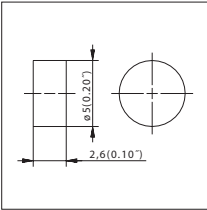
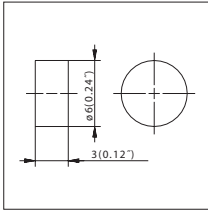
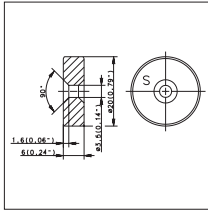
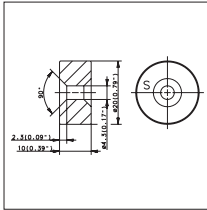



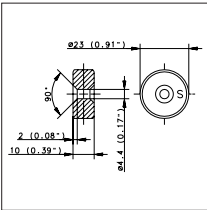
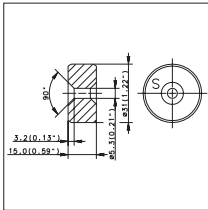
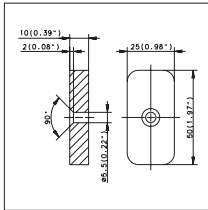
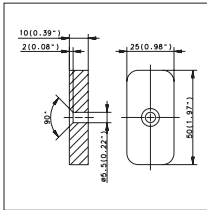

Applications

- Counting
- Position indication in lifts
- End position switches in pneumatic and hydraulic installations
- Position indication on butterfly valves, slide valves and valves in general
- Conveyors in high-bay shelving
- Position detection in textile, packaging and meat cutting machines
- Machine runtime and downtime monitoring
- Control of machine tools
- Level monitoring of liquids (see Float Switches)



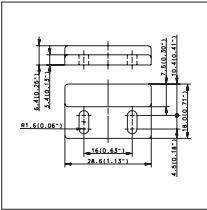
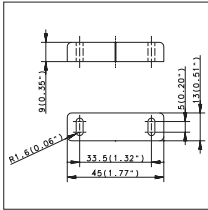
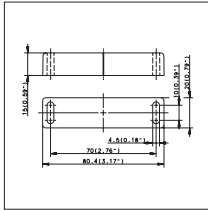
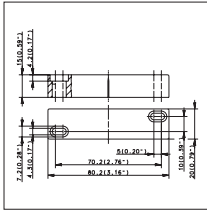

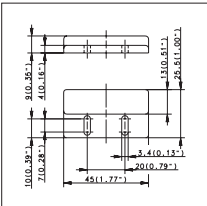
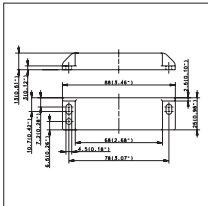
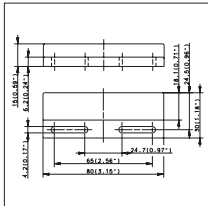

Actuating Magnets without Encapsulation

Actuating magnets without encapsulation	T-75	T-06N/S	T-61N/S	T-67N/S
				
Magnet material	Rare-earth	Neodymium iron boron (NdFeB)	Barium ferrite	Barium ferrite
Temperature range (magnetic switch operation)	-40 °C ... +150 °C -40 °F ... +302 °F	-40 °C ... +150 °C -40 °F ... +302 °F	-40 °C ... +150 °C -40 °F ... +302 °F	-40 °C ... +150 °C -40 °F ... +302 °F
Temperature coefficient	0.2 %/K	0.2 %/K	0.2 %/K	0.2 %/K
Enclosure material	-	-	-	-
Article number	6301175057	6301106065	6301261035	6301167054
Dimensioned drawing				
		Marking slots on north pole side		
Actuating magnets without encapsulation	T-62N/S	T-69N/S	T-68N	T-68S
				
Magnet material	Barium ferrite	Barium ferrite	Barium ferrite	Barium ferrite
Temperature range (magnetic switch operation)	-40 °C ... +150 °C -40 °F ... +302 °F	-40 °C ... +150 °C -40 °F ... +302 °F	-40 °C ... +150 °C -40 °F ... +302 °F	-40 °C ... +150 °C -40 °F ... +302 °F
Temperature coefficient	0.2 %/K	0.2 %/K	0.2 %/K	0.2 %/K
Enclosure material	-	-	-	-
Article number	6301262039	6301269031	6301268028	6301368033
Dimensioned drawing				
			90° countersink on north pole side	90° countersink on south pole side

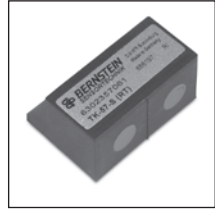
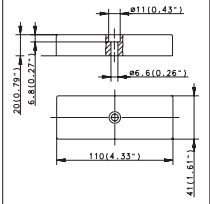
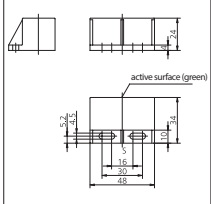
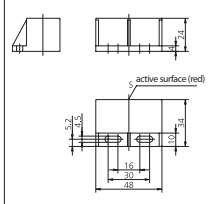

Actuating Magnets in Plastic Enclosure

Actuating magnets in plastic enclosure	TK-11-11	TK-11-01	TK-21-02	TK-21-12
				
Magnet material	AlNiCo-500	AlNiCo-500	AlNiCo-500	AlNiCo-500
Temperature range (magnetic switch operation)	-20 °C ... +80 °C -4 °F ... +176 °F	-20 °C ... +80 °C -4 °F ... +176 °F	-20 °C ... +80 °C -4 °F ... +176 °F	-20 °C ... +80 °C -4 °F ... +176 °F
Temperature coefficient	0.2 %/K	0.2 %/K	0.2 %/K	0.2 %/K
Enclosure material	PA 6.6	PA 6.6	PA 6.6	PA 6.6
Article number	6302111047	6303111001	6303121002	6302121030
Dimensioned drawing				
Actuating magnets in plastic enclosure	TK-45	TK-42	TK-44	
				
Magnet material	AlNiCo-500	AlNiCo-500	AlNiCo-500	
Temperature range (magnetic switch operation)	-20 °C ... +80 °C -4 °F ... +176 °F	-20 °C ... +80 °C -4 °F ... +176 °F	-20 °C ... +80 °C -4 °F ... +176 °F	
Temperature coefficient	0.2 %/K	0.2 %/K	0.2 %/K	
Enclosure material	PA 6.6	PA 6.6	PA 6.6	
Article number	6302145048	6302142049	6302144050	
Dimensioned drawing				

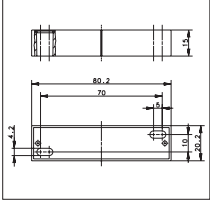
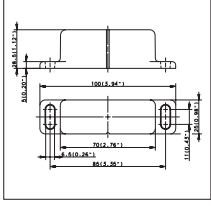
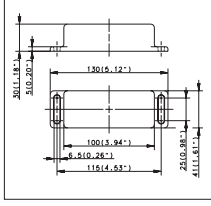

Actuating Magnets

Actuating magnets in plastic enclosure	TK-50	TK-57N	TK-57S
			
<p>Magnet material</p> <p>Temperature range (magnetic switch operation)</p> <p>Temperature coefficient</p> <p>Enclosure material</p> <p>Article number</p> <p>Dimensioned drawing</p>	<p>Barium ferrite</p> <p>-20 °C ... +80 °C -4 °F ... +176 °F</p> <p>0.2 %/K</p> <p>PA 6.6</p> <p>6302100053</p>	<p>Barium ferrite</p> <p>-20 °C ... +80 °C -4 °F ... +176 °F</p> <p>0.2 %/K</p> <p>PBT</p> <p>6302257060</p>	<p>Barium ferrite</p> <p>-20 °C ... +80 °C -4 °F ... +176 °F</p> <p>0.2 %/K</p> <p>PBT</p> <p>6302357061</p>
			
Actuating magnets in metal enclosure	TA-21-02	TA-31	TA-33
			
<p>Magnet material</p> <p>Temperature range (magnetic switch operation)</p> <p>Temperature coefficient</p> <p>Enclosure material</p> <p>Article number</p> <p>Dimensioned drawing</p>	<p>AlNiCo-500</p> <p>-40 °C ... +150 °C -40 °F ... +302 °F</p> <p>0.2 %/K</p> <p>Al</p> <p>6305121064</p>	<p>AlNiCo-500</p> <p>-20 °C ... +80 °C -4 °F ... +176 °F</p> <p>0.2 %/K</p> <p>Al</p> <p>6303131005</p>	<p>Barium ferrite</p> <p>-20 °C ... +80 °C -4 °F ... +176 °F</p> <p>0.2 %/K</p> <p>Al</p> <p>6303133034</p>
			



Mounting Brackets

Mounting brackets	BWN-M06NI/40 x 47	BWN-M06NI/27 x 38	BWN-M36NI
			
Material	Niro 1.4301	Niro 1.4301	Niro 1.4301
For series	MA-06, MA-16, MA-26, MA-15	MA-06, MA-16, MA-26, MA-15	MA-06, MA-16, MA-26, MA-15
Article number	4102802001	4102802002	4904700035
Dimensioned drawing			

Miniature Snap-In Connectors

Miniature snap-in connectors		Ø 6.5 mm	Ø 6.5 mm
Contact assignments 1 = Brown 2 = Black 3 = Blue			
			
Cable material		PUR	PUR
Coupler material		PA 12	PA 12
Coupling ring material		POM	POM
Temperature range		-25 °C ... +90 °C -13 °F ... +194 °F	-25 °C ... +90 °C -13 °F ... +194 °F
Switching function		Universal	Universal
Cable structure		3 x 0.25 mm ²	3 x 0.25 mm ²
Protection class		IP67/NEMA 4	IP67/NEMA 4
Article number	2,5 m	4139100219 GDK-R06US/SO0-2,5PU	4139100221 WDK-R06US/SO0-2,5PU
Type	5 m	4139100220 GDK-R06US/SO0-5PU	4139100222 WDK-R06US/SO0-5PU
Type	10 m	4139100239 GDK-R06US/SO0-10PU	4139100267 WDK-R06US/SO0-10PU

Connectors

Cable connector M8 x 1	M8	M8	M8
Contact assignments 1 = Brown 2 = Black 3 = Blue			
Cable material	PVC	PVC	PVC
Coupler material	TPU	PUR	PUR
Coupling ring material	CuZn39Pb3	CuZn39Pb3	CuZn39Pb3
Temperature range	-25/+90 °C	-25/+90 °C	-25/+90 °C
Switching function	PNP/LED	Universal	Universal
Cable structure	3 x 0.25 mm ²	3 x 0.25 mm ²	3 x 0.25 mm ²
Protection class	IP67	IP68	IP68
Article number	2 m	4139100213 WDK-M08PS/LL2-2	4139100798 WDK-M08US/WO0-2
Type	5 m	4139100216 WDK-M08PS/LL2-5	4139100799 WDK-M08US/WO0-5
Type	10 m	4139100797 GDK-M08US/WO0-10	4139100800 WDK-M08US/WO0-10

Cable connector M12 x 1	M12 3-wire	M12 3-wire	M12 4-wire	M12 4-wire
Contact assignments 1 = Brown 2 = White 3 = Blue 4 = Black				
Cable material	PVC	PVC	PVC	PUR
Coupler material	PUR	PUR	PA	PUR
Coupling ring material	CuZn39Pb3	CuZn39Pb3	CuZn39Pb3	CuZn39Pb3
Temperature range	-25/+90 °C	-25/+90 °C	-25/+90 °C	-25/+90 °C
Switching function	Universal	Universal	Universal	PNP/LED
Cable structure	3 x 0.34 mm ²	3 x 0.34 mm ²	4 x 0.25 mm ²	4 x 0.25 mm ²
Protection class	IP68	IP68	IP68	IP67
Article number	4139100801	4139100804		4139100244
Type	GDK-M12US/WO0-2	WDK-M12US/WO0-2		WDK-M12PA/SL2-2PU
5 m	4139100802	4139100468	4139100903	4139100245
Type	GDK-M12US/WO0-5	WDK-M12US/WO0-5	WDK-M12UA/WO0-5	WDK-M12PA/SL2-5PU
10 m	4139100803	4139100805	4139100467	4139100254
Type	GDK-M12US/WO0-10	WDK-M12US/WO0-10	WDK-M12UA/WO0-10	WDK-M12PA/SL2-10PU

Cable connector M12 x 1	M12	M12	M12 3-wire	M12 5-wire
Contact assignments 1 = Brown 2 = White 3 = Blue 4 = Black				
Cable material	-	-	PVC	PUR
Coupler material	PA	PA	TPU	PUR
Coupling ring material	CuZn39Pb3	CuZn39Pb3	CuZn39Pb3	CuZn39Pb3
Temperature range	-25/+90 °C	-25/+90 °C	-25/+90 °C	-25/+90 °C
Switching function	Universal	Universal	PNP/LED	Universal
Cable structure	-	-	3 x 0.4 mm ²	5 x 0.34 mm ²
Protection class	IP67	IP67	IP68	IP68
Article number	4139100102	4139100101	4139100553	4139100956
Type	GDA-M12UA/LO	WDA-M12UA/LO	WDK-M12PS/LL2-2	GDK-M12UU/HO-2PU
5 m			4139100554	
Type			WDK-M12PS/LL2-6	
10 m				
Type				

Reflectors

Triple reflectors are best suited for the purpose of reflecting light in light barrier systems. Reflective films are only used as a second choice alternative. Triple reflectors are designed as small, pyramid-shaped triple mirrors, joined to provide a reflection surface. Three pyramid-shaped mirror surfaces joined at 90° reflect the incident light three times on one mirror surface. They reflect the light beam by 180° back in the source direction. Vibration, slight movement and displacement up to 30° with respect to the optical axis of the triple reflector do not interrupt the light beam.

A reflective film can also be tilted or displaced. In this case, in contrast to the triple reflector, the degree of reflection diminishes considerably as such films use small mirrors together with micro glass pearls to reflect light. An advantage of reflective film, however, is its flexibility in installation. Although its reflection quality can be improved by means of a triple structure in the film, it still does not match the degree of reflection achieved by a triple reflector. In general, a plane mirror must not be displaced. The angle of incidence of the light beam directed at such mirrors must precisely correspond to the angle of reflection about the optical axis to ensure effective reflection in the light barrier receiver (optoelectric sensor).

The specified ranges of the reflection light barriers refer to the RTS-083 KK and RTS-060 KK reflector. Essentially, the size of the reflector should be selected according to the sensing range and the size of the object to be detected. The object should ideally be larger than the reflector so that it completely covers the reflector.

Example: OR20RS

Reflector	Range
RTS-D33 KK	4.0 m
RTS-D83 KK	8.0 m
RTS-60 KK	8.0 m
RFS-100 KK	6.0 m

Ranges of other reflection light barriers available on request.

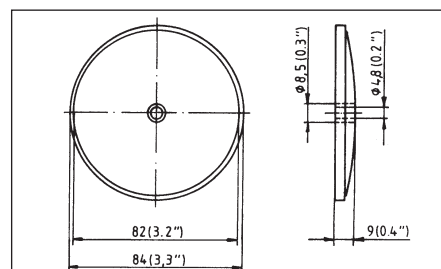
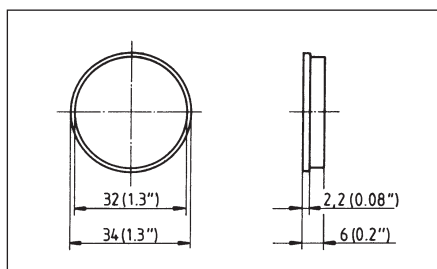

Type designation	RTS-D33 KK	RTS-D83 KK
Article number	6572110010	6572107003
Diameter	33 mm	83 mm

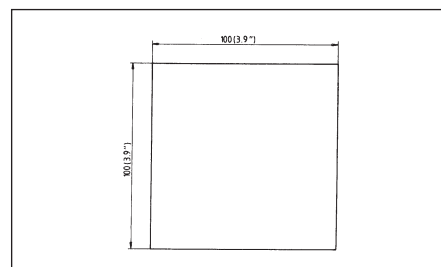
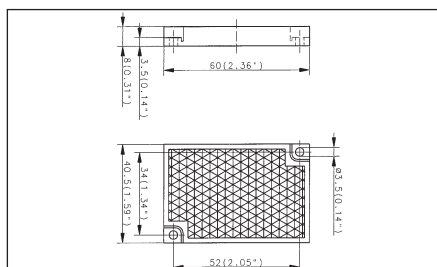

Type designation	RTS-60 KK	RFS-100 KK
Article number	6572100007	6572300001
Structure	60 x 41 mm	100 x 100 mm Self-adhesive film

Mounting Material

Other mounting brackets available on request.

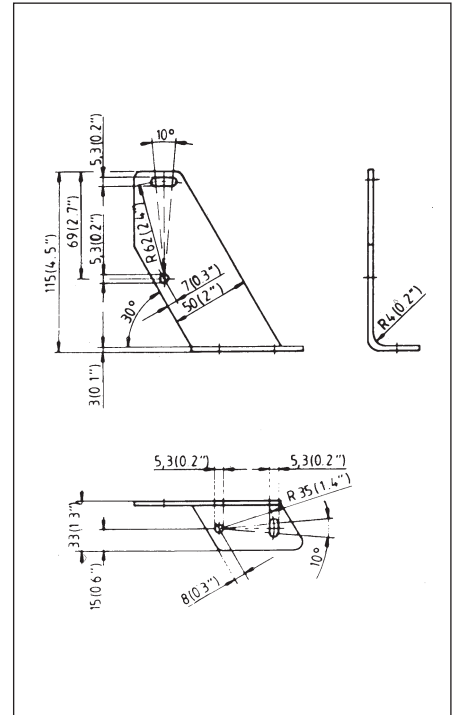
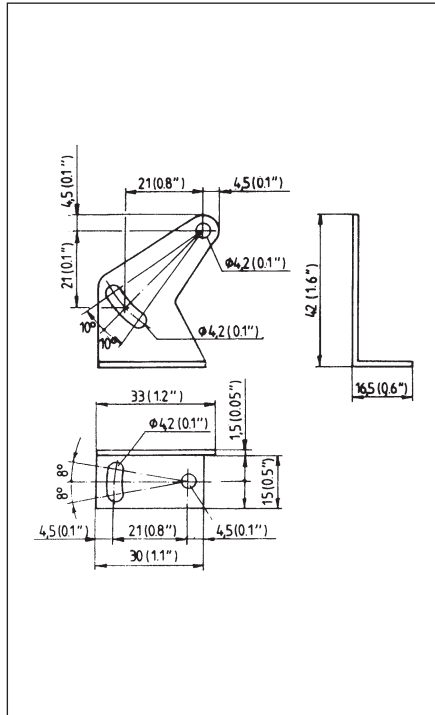

Type designation	BWN-L05ST KPL	BWN-L20NI KPL
Article number	6571300003	6571200002

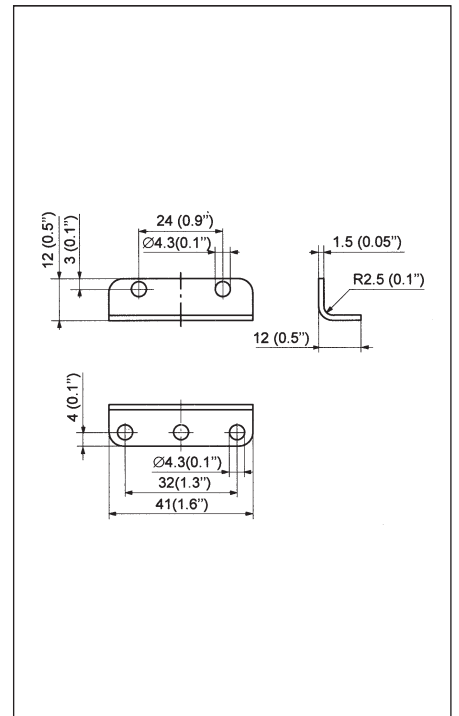
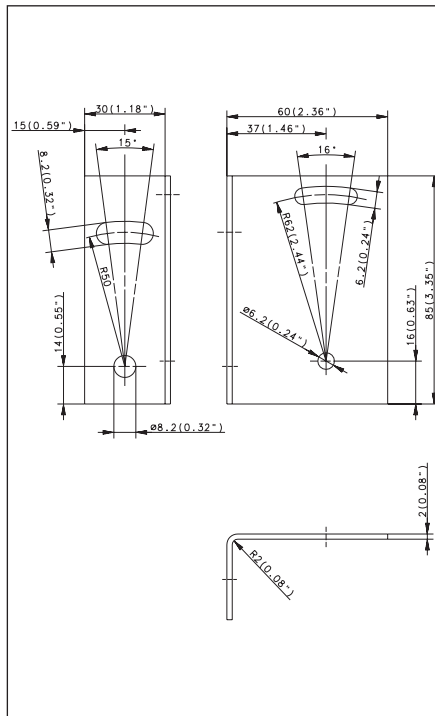

Type designation	BWN-L20NI KPL	BWN-L12AL KPL
Article number	6571200007	6571500006

Mounting Brackets

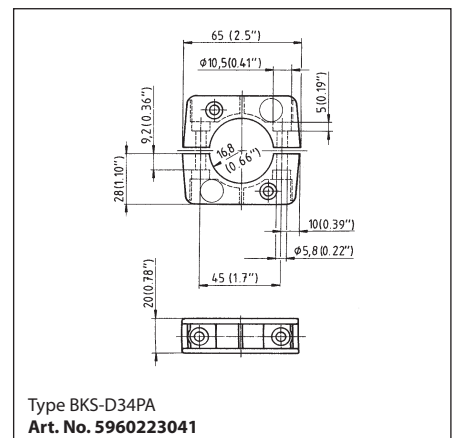
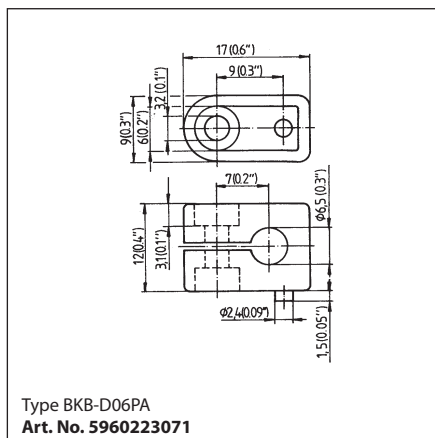
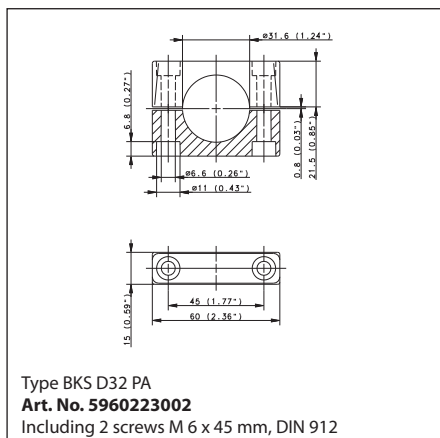
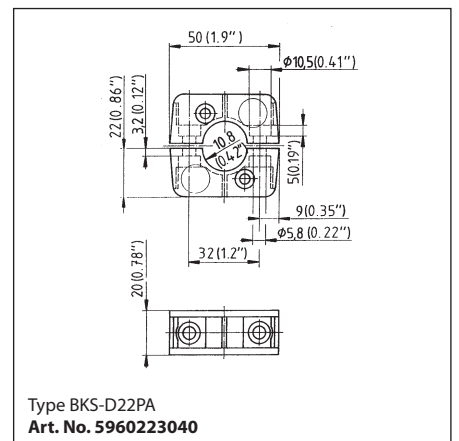
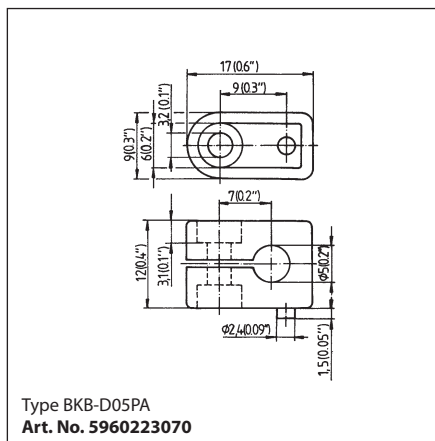
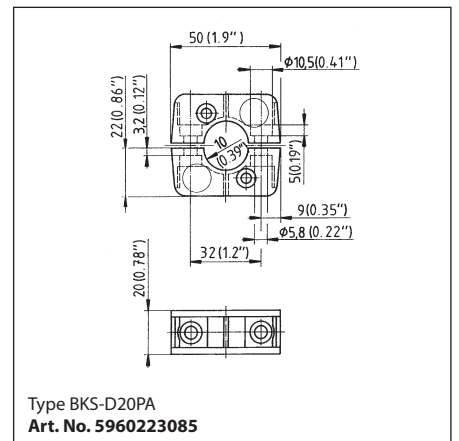
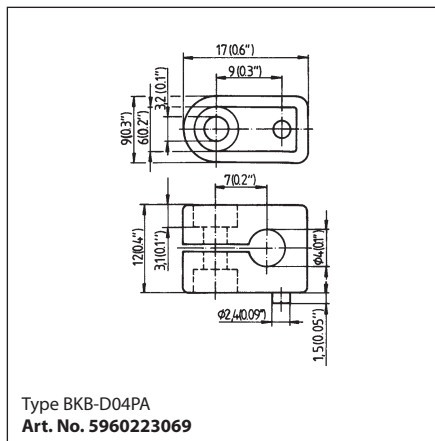

Sensor Tester



Technical data

Type designation	Sensor Tester
Article number	6510000048
Function	Sensor tester for DC 2-wire and 3-wire proximity switches Test function: Checking and indicating the switching status of a sensor with visual and acoustic signal
Power supply	9 V block battery (6LR61)
Output voltage	15 VDC, 20 mA stabilised
Enclosure	Modified enclosure of Series OR20
Temperature range	min/max -25 °C/+70 °C
Input signals	NPN/PNP 3-wire, DC 2-wire, NAMUR

The sensor tester is used for checking 2-wire and 3-wire DC proximity switches. Coloured LEDs and an acoustic signal are used to indicate the switching statuses.

Green LED: Operating voltage

Red LED: Low battery

Yellow LED: Sensor switching status

When not in use, the sensor tester switches off automatically after approx. 30 s.

Connection assignments

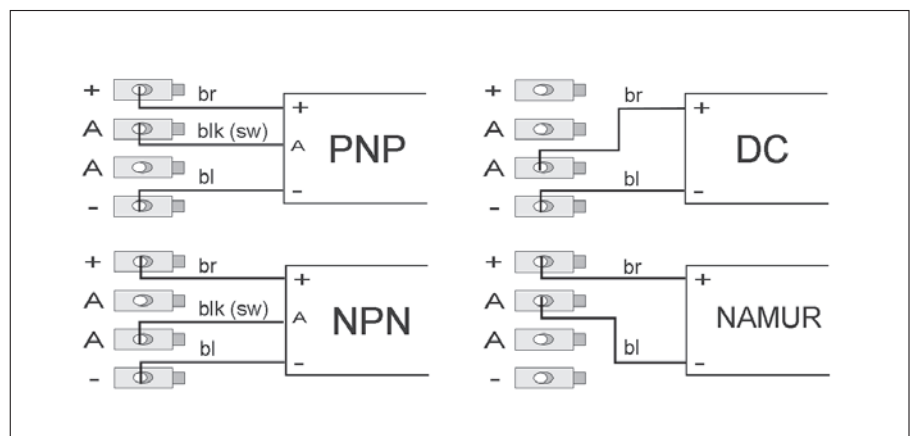

Inductive Sensors

1	2	3	4	5	6	7	8	9	10	11	12	13	14	15	16	17	18	19	+
K	I	N	-	T	1	2	N	S	/	0	0	4	-	K	L	2			
Product group			Type of enclosure				Output		Sensing distance				Options						

Product group		
1	K	Non-contact proximity switch
2	I	Inductive
3	B	Flush mount
	N	Non-flush mount
	R	Ring sensor
4	-	Dash (fixed)
Type of enclosure		
5	M	Metric thread (metal enclosure)
	T	Metric thread (plastic enclosure)
	D	Round enclosure (metal)
	R	Round enclosure (plastic)
	Q	Cuboid enclosure (metal)
	P	PG thread (metal)
	E	Rectangular enclosure (plastic)
	S	Slot proximity switch (plastic)
	N	Standard mounting (to DIN 50025/50037)
	C	Compact enclosure
6 – 7		Two-digit number for:
		Round types = Ø as specified
		Threaded types = standard designation
		Rectangular types = consecutive type numbers

Design examples		
	D08	Ø 8 mm (metal)
	R22	Ø 22 mm (plastic)
	M12	Threaded barrel M12 x 1
Rectangular and other types		
	E16	16 x 5 x 5 mm
	E27	27 x 10 x 5.5 mm
	E28	28 x 16 x 11 mm
	E40	40 x 26 x 12 mm
	E50	50 x 25 x 10 mm
	E68	68 x 30 x 15 mm
	G00	Tube thread, general
	N44	41.5 x 41.5 x 120 mm
	Q05	5 x 5 x 25 mm
	Q08	8 x 8 x 40 mm, Side active
	Q12	12 x 12 x 55 mm

Output		
8	P	PNP
	N	NPN
	A	AC 2-wire
	E	NAMUR
	Z	DC 2-wire
	R	Relay
	G	Push-pull
	D	Dual output stage (NPN/PNP selectable)
9	S	NO contact
	Ö	NC contact
	P	Programmable
	A	Analogue
	U	Antivalent (selectable)
10	/	Slash (fixed)
Sensing distance		
11 – 13	f. ex. 1.5	1.5 mm
	f. ex. 002	2.0 mm
	f. ex. 040	40 mm
14	-	Dash (fixed)
Options		
15 – 17		See type code "OPTIONS", p. 173

Inductive Sensors (sort by type designation)

Type	Art. No.	Page	Type	Art. No.	Page	Type	Art. No.	Page
KIB-D03PÖ/0,6-KL2PU	6502799007	14	KIB-M18PS/005-KL2PUT	6502905023	24	KIN-M12PS/004-KL2V	6502904014	21
KIB-D03PS/0,6-KL2PU	6502999019	14	KIB-M18PS/005-KL6V	6502905013	23	KIN-M12PS/004-KLS12	6932944001	21
KIB-D04NS/0,8-KL2PU	6502399004	14	KIB-M18PS/005-KLS12	6932905004	23	KIN-M12PS/004-KS12V	6502944006	21
KIB-D04PÖ/0,8-KL2PU	6502799002	14	KIB-M18PS/005-KLS12T	6502940006	24	KIN-M12PS/008-KL2E	6502904021	22
KIB-D04PS/0,8-KL2PU	6502999004	14	KIB-M18PS/005-KLSD	6602905662	23	KIN-M12PS/008-KLS12E	6502944013	22
KIB-D06PÖ/1,5-KL2	6502799011	14	KIB-M18PS/005-KLSDV	6502940001	23	KIN-M18AÖ/008-L2	6503406001	25
KIB-D06PS/1,5-K2VPU	6502999034	15	KIB-M18PS/005-KS12V	6502905012	23	KIN-M18AS/008-L2	6503506002	25
KIB-D06PS/1,5-KL2	6502999010	14	KIB-M18PS/008-KL2E	6502905022	24	KIN-M18NS/008-KL2	6932306001	25
KIB-D06PS/1,5-KL5V	6602999460	15	KIB-M18PS/008-KL2VE	6502905010	25	KIN-M18NS/008-KL2V	6502306004	26
KIB-D06PS/1,5-KLSM8	6502999012	14	KIB-M18PS/008-KLS12E	6502940005	24	KIN-M18NS/008-KLS12	6932306004	26
KIB-E27PS/1,5-KL2PU	6502993001	33	KIB-M18PS/008-KS12V	6502906009	25	KIN-M18NS/008-KLS12U	6502306011	27
KIB-E28PÖ/002-KLSM8	6502773001	33	KIB-M18PU/005-KSDV	6502840002	23	KIN-M18PA/008-2	6502006001	27
KIB-E28PS/002-KL2	6502973001	33	KIB-M18PU/008-KSDVE	6602840128	25	KIN-M18PA/008-S12	6602006111	27
KIB-E28PS/002-KLSM8	6502973002	33	KIB-M30AÖ/010-L2	6503407240	28	KIN-M18PÖ/008-KL2	6932706001	25
KIB-E40AS/002-L2	6503584004	34	KIB-M30AÖ/010-LSD	6503435959	29	KIN-M18PÖ/008-KL2V	6502706002	26
KIB-E40PÖ/002-KL2	6502784006	34	KIB-M30AS/010-L2	6503507378	28	KIN-M18PÖ/008-KLS12	6932706002	26
KIB-E40PS/002-KL2	6502984023	34	KIB-M30AS/010-LSD	6503535960	29	KIN-M18PÖ/008-KLSD	6502741001	27
KIB-E40PS/002-KLSM8	6502984025	34	KIB-M30EA/010-2	6501699012	30	KIN-M18PS/008-KL2	6932906001	25
KIB-E50NS/005-KL2	6502399001	35	KIB-M30PÖ/010-KL2V	6502707001	28	KIN-M18PS/008-KL2V	6502906006	26
KIB-E50PS/005-KL2	6502990001	35	KIB-M30PS/010-KL2	6932907001	28	KIN-M18PS/008-KLS12	6932906004	26
KIB-E50PS/005-KLSM8	6502990005	35	KIB-M30PS/010-KL2PUT	6502907013	29	KIN-M18PS/008-KLSD	6502941001	27
KIB-M04PS/0,6-KL2PU	6502999020	15	KIB-M30PS/010-KL2V	6502907003	28	KIN-M18PS/016-KL2E	6502906018	28
KIB-M05EA/001-2	6501699008	15	KIB-M30PS/010-KLS12	6932907002	28	KIN-M18PS/016-KLS12E	6502941004	28
KIB-M05NS/001-KL2PU	6502399003	15	KIB-M30PS/010-KLS12T	6502939006	29	KIN-M18PU/008-KSD	6602841421	27
KIB-M05PÖ/001-KL2PU	6502799001	15	KIB-M30PS/010-KLSD	6502939001	29	KIN-M18ZS/008-L2	6501306001	26
KIB-M05PÖ/001-KLSM8	6502799019	15	KIB-Q08PÖ/1,5-K2	6502780001	32	KIN-M30AS/015-L2,5	6503508246	30
KIB-M05PS/001-KL2PU	6502999003	15	KIB-Q08PÖ/1,5-KLSM8	6502780002	32	KIN-M30NS/015-KL2	6502308001	30
KIB-M05PS/001-KLSM8	6502999018	15	KIB-Q08PS/1,5-K2	6502980004	32	KIN-M30NS/015-KLS12	6602308459	30
KIB-M08EA/1,5-2	6501601003	17	KIB-Q08PS/1,5-K2T	6602980087	32	KIN-M30PA/015-2	6502008001	31
KIB-M08NS/1,5-KL2	6932301001	16	KIB-Q08PS/1,5-KLSM8	6502980002	32	KIN-M30PS/015-KL2	6932908001	30
KIB-M08NS/1,5-KLSM8	6932342001	16	KIB-Q12NS/004-KLSM8E	6502399021	33	KIN-M30PS/015-KL2	6502908002	30
KIB-M08PÖ/1,5-KL2	6502701001	16	KIB-Q12PS/004-KL2E	6502999028	33	KIN-M30PS/015-KLS12	6932908002	30
KIB-M08PÖ/1,5-KLSM8	6502742001	16	KIB-Q12PS/004-KLSM8E	6502999030	33	KIN-M30PS/015-KLSD	6502935001	31
KIB-M08PS/1,5-KL2	6932901001	16	KIB-T18AS/005-L2	6503520697	23	KIN-M30PS/040-KL2E	6502908009	31
KIB-M08PS/1,5-KL6	6502901004	16	KIB-T18PS/005-KL2	6502920990	23	KIN-M30PU/015-KL2	6502808001	30
KIB-M08PS/1,5-KLSM8	6932942001	16	KIB-T30PÖ/010-KL2	6502722708	29	KIB-Q05PS/001-K2PU	6502999026	32
KIB-M08PS/1,5-KS12	6502942007	16	KIB-T30PP/010-KLSD	6502822862	29	KIB-Q05PÖ/001-K2PU	6502799010	32
KIB-M12AS/002-L2	6503503001	18	KIN-E40AS/004-L2	6503584005	34			
KIB-M12EA/002-2	6501624760	19	KIN-E40PÖ/004-KL2	6502784007	34			
KIB-M12NÖ/002-KL2V	6502103003	18	KIN-E40PÖ/004-KLSM8	6502784008	34			
KIB-M12NS/002-KL2	6932303001	18	KIN-E40PS/004-KL2	6502984024	34			
KIB-M12NS/002-KLS12	6932343001	18	KIN-E40PS/004-KLSM8	6502984026	34			
KIB-M12PÖ/002-KL2V	6502703005	18	KIN-E50NS/008-KL2	6502390002	35			
KIB-M12PÖ/002-KLS12	6602743112	18	KIN-E50PÖ/008-KL2	6502790002	35			
KIB-M12PÖ/002-KS12V	6502743005	19	KIN-E50PS/008-KL2	6502990003	35			
KIB-M12PS/002-KL2	6932903001	18	KIN-E50PS/008-KLSM8	6502990006	35			
KIB-M12PS/002-KL2F	6502903012	19	KIN-E60PÖ/008-KLSM8	6602799048	35			
KIB-M12PS/002-KL2V	6502903016	18	KIN-E68NÖ/007-KL6	6502156058	36			
KIB-M12PS/002-KLS12	6932943001	18	KIN-E68PS/007-KL2	6502956076	36			
KIB-M12PS/002-KLSM8V	6502943008	19	KIN-M08EA/002-2	6501601005	18			
KIB-M12PS/002-KS12V	6502943006	19	KIN-M08PS/002-KL2	6502916003	17			
KIB-M12PS/004-KL2E	6502903025	20	KIN-M08PS/002-KLSM8	6502942006	17			
KIB-M12PS/004-KL2VE	6502903023	20	KIN-M08PS/002-KS12	6502942008	17			
KIB-M12PS/004-KLS12E	6502943015	20	KIN-M12AÖ/004-L2	6503404001	20			
KIB-M18AÖ/005-L2	6503405001	22	KIN-M12AS/004-L2	6503504001	20			
KIB-M18AS/005-L2	6503505004	22	KIN-M12EA/004-2	6501625761	22			
KIB-M18EA/005-2	6501626762	24	KIN-M12NÖ/004-KL2	6932104001	20			
KIB-M18NÖ/005-KL2	6932105001	22	KIN-M12NS/004-KL2	6932304001	20			
KIB-M18NS/005-KLS12	6932305004	23	KIN-M12NS/004-KLS12	6932344001	21			
KIB-M18PÖ/005-KL2	6932705001	22	KIN-M12NS/008-KLS12E	6602344458	22			
KIB-M18PÖ/005-KLSD	6502705001	23	KIN-M12PÖ/004-KL2	6932704001	20			
KIB-M18PÖ/005-KS12V	6502705007	23	KIN-M12PÖ/004-KLS12	6502744003	21			
KIB-M18PS/005-KL2	6932905001	22	KIN-M12PS/004-KL2	6932904001	20			

Inductive Sensors (sort by type designation)

Type	Art. No.	Page		
KIN-N40PP/015-KLSD	6502982001	36		
KIN-N40PS/020-KLS12	6502982003	36		
KIN-R34PP/020-KLSD	6502915001	32		
KIN-R34PS/020-KL2	6502915002	32		
KIN-T12PS/004-KL2	6502919001	21		
KIN-T18AÖ/008-L2	6503421704	26		
KIN-T18AS/008-L2	6503521705	26		
KIN-T18PS/008-KL2	6502921975	26		
KIN-T30AS/015-L2,5	6503523956	31		
KIN-T30PP/015-KLSD	6502836860	31		
KIN-T30PS/015-KL2	6502923981	31		
KIR-N40PS/000-KL6	6502999036	36		

Inductive Sensors (sort by article number)

Art. No.	Type	Page	Art. No.	Type	Page	Art. No.	Type	Page
6501306001	KIN-M18ZS/008-L2	26	6502907013	KIB-M30PS/010-KL2PUT	29	6503508246	KIN-M30AS/015-L2,5	30
6501601003	KIB-M08EA/1,5-2	17	6502908002	KIN-M30PS/015-KL2	30	6503520697	KIB-T18AS/005-L2	23
6501601005	KIN-M08EA/002-2	18	6502908009	KIN-M30PS/040-KL2E	31	6503521705	KIN-T18AS/008-L2	26
6501624760	KIB-M12EA/002-2	19	6502915001	KIN-R34PP/020-KLSD	32	6503523956	KIN-T30AS/015-L2,5	31
6501625761	KIN-M12EA/004-2	22	6502916003	KIN-M08PS/002-KL2	17	6503535960	KIB-M30AS/010-LSD	29
6501626762	KIB-M18EA/005-2	24	6502919001	KIN-T12PS/004-KL2	21	6503584004	KIB-E40AS/002-L2	34
6501699008	KIB-M05EA/001-2	15	6502920990	KIB-T18PS/005-KL2	23	6503584005	KIN-E40AS/004-L2	34
6501699012	KIB-M30EA/010-2	30	6502921975	KIN-T18PS/008-KL2	26	6602006111	KIN-M18PA/008-S12	27
6502006001	KIN-M18PA/008-2	27	6502923981	KIN-T30PS/015-KL2	31	6602308459	KIN-M30NS/015-KLS12	30
6502008001	KIN-M30PA/015-2	31	6502935001	KIN-M30PS/015-KLSD	31	6602344458	KIN-M12NS/008-KLS12E	22
6502103003	KIB-M12NÖ/002-KL2V	18	6502939001	KIB-M30PS/010-KLSD	29	6602743112	KIB-M12PÖ/002-KLS12	18
6502156058	KIN-E68NÖ/007-KL6	36	6502939006	KIB-M30PS/010-KLS12T	29	6602799048	KIN-E60PÖ/008-KLSM8	35
6502306004	KIN-M18NS/008-KL2V	26	6502940001	KIB-M18PS/005-KLSDV	23	6602840128	KIB-M18PU/008-KSDVE	25
6502306011	KIN-M18NS/008-KLS12U	27	6502940005	KIB-M18PS/008-KLS12E	24	6602841421	KIN-M18PU/008-KSD	27
6502308001	KIN-M30NS/015-KL2	30	6502940006	KIB-M18PS/005-KLS12T	24	6602905662	KIB-M18PS/005-KLSD	23
6502390001	KIB-E50NS/005-KL2	35	6502941001	KIN-M18PS/008-KLSD	27	6602980087	KIB-Q08PS/1,5-K2T	32
6502390002	KIN-E50NS/008-KL2	35	6502941004	KIN-M18PS/016-KLS12E	28	6602999460	KIB-D06PS/1,5-KL5V	15
6502399003	KIB-M05NS/001-KL2PU	15	6502942006	KIN-M08PS/002-KLSM8	17	6932104001	KIN-M12NÖ/004-KL2	20
6502399004	KIB-D04NS/0,8-KL2PU	14	6502942007	KIB-M08PS/1,5-KS12	16	6932105001	KIB-M18NÖ/005-KL2	22
6502399021	KIB-Q12NS/004-KLSM8E	33	6502942008	KIN-M08PS/002-KS12	17	6932301001	KIB-M08NS/1,5-KL2	16
6502701001	KIB-M08PÖ/1,5-KL2	16	6502943006	KIB-M12PS/002-KS12V	19	6932303001	KIB-M12NS/002-KL2	18
6502703005	KIB-M12PÖ/002-KL2V	18	6502943008	KIB-M12PS/002-KLSM8V	19	6932304001	KIN-M12NS/004-KL2	20
6502705001	KIB-M18PÖ/005-KLSD	23	6502943015	KIB-M12PS/004-KLS12E	20	6932305004	KIB-M18NS/005-KLS12	23
6502705007	KIB-M18PÖ/005-KS12V	23	6502944006	KIN-M12PS/004-KS12V	21	6932306001	KIN-M18NS/008-KL2	25
6502706002	KIN-M18PÖ/008-KL2V	26	6502944013	KIN-M12PS/008-KLS12E	22	6932306004	KIN-M18NS/008-KLS12	26
6502707001	KIB-M30PÖ/010-KL2V	28	6502956076	KIN-E68PS/007-KL2	36	6932342001	KIB-M08NS/1,5-KLSM8	16
6502722708	KIB-T30PÖ/010-KL2	29	6502973001	KIB-E28PS/002-KL2	33	6932343001	KIB-M12NS/002-KLS12	18
6502741001	KIN-M18PÖ/008-KLSD	27	6502973002	KIB-E28PS/002-KLSM8	33	6932344001	KIN-M12NS/004-KLS12	21
6502742001	KIB-M08PÖ/1,5-KLSM8	16	6502980002	KIB-Q08PS/1,5-KLSM8	32	6932704001	KIN-M12PÖ/004-KL2	20
6502743005	KIB-M12PÖ/002-KS12V	19	6502980004	KIB-Q08PS/1,5-K2	32	6932705001	KIB-M18PÖ/005-KL2	22
6502744003	KIN-M12PÖ/004-KLS12	21	6502982001	KIN-N40PP/015-KLSD	36	6932706001	KIN-M18PÖ/008-KL2	25
6502773001	KIB-E28PÖ/002-KLSM8	33	6502982003	KIN-N40PS/020-KLS12	36	6932706002	KIN-M18PÖ/008-KLS12	26
6502780001	KIB-Q08PÖ/1,5-K2	32	6502984023	KIB-E40PS/002-KL2	34	6932901001	KIB-M08PS/1,5-KL2	16
6502780002	KIB-Q08PÖ/1,5-KLSM8	32	6502984024	KIN-E40PS/004-KL2	34	6932903001	KIB-M12PS/002-KL2	18
6502784006	KIB-E40PÖ/002-KL2	34	6502984025	KIB-E40PS/002-KLSM8	34			
6502784007	KIN-E40PÖ/004-KL2	34	6502984026	KIN-E40PS/004-KLSM8	34			
6502784008	KIN-E40PÖ/004-KLSM8	34	6502990001	KIB-E50PS/005-KL2	35			
6502790002	KIN-E50PÖ/008-KL2	35	6502990003	KIN-E50PS/008-KL2	35			
6502799001	KIB-M05PÖ/001-KL2PU	15	6502990005	KIB-E50PS/005-KLSM8	35			
6502799002	KIB-D04PÖ/0,8-KL2PU	14	6502990006	KIN-E50PS/008-KLSM8	35			
6502799007	KIB-D03PÖ/0,6-KL2PU	14	6502993001	KIB-E27PS/1,5-KL2PU	33			
6502799010	KIB-Q05PÖ/001-K2PU	32	6502999003	KIB-M05PS/001-KL2PU	15			
6502799011	KIB-D06PÖ/1,5-KL2	14	6502999004	KIB-D04PS/0,8-KL2PU	14			
6502799019	KIB-M05PÖ/001-KLSM8	15	6502999010	KIB-D06PS/1,5-KL2	14			
6502808001	KIN-M30PU/015-KL2	30	6502999012	KIB-D06PS/1,5-KLSM8	14			
6502822862	KIB-T30PP/010-KLSD	29	6502999018	KIB-M05PS/001-KLSM8	15			
6502836860	KIN-T30PP/015-KLSD	31	6502999019	KIB-D03PS/0,6-KL2PU	14			
6502840002	KIB-M18PU/005-KSDV	23	6502999020	KIB-M04PS/0,6-KL2PU	15			
6502901004	KIB-M08PS/1,5-KL6	16	6502999026	KIB-Q05PS/001-K2PU	32			
6502903012	KIB-M12PS/002-KL2F	19	6502999028	KIB-Q12PS/004-KL2E	33			
6502903016	KIB-M12PS/002-KL2V	18	6502999030	KIB-Q12PS/004-KLSM8E	33			
6502903023	KIB-M12PS/004-KL2VE	20	6502999034	KIB-D06PS/1,5-K2VPU	15			
6502903025	KIB-M12PS/004-KL2E	20	6502999036	KIN-N40PS/000-KL6	36			
6502904014	KIN-M12PS/004-KL2V	21	6503404001	KIN-M12AÖ/004-L2	20			
6502904021	KIN-M12PS/008-KL2E	22	6503405001	KIB-M18AÖ/005-L2	22			
6502905010	KIB-M18PS/008-KL2VE	25	6503406001	KIN-M18AÖ/008-L2	25			
6502905012	KIB-M18PS/005-KS12V	23	6503407240	KIB-M30AÖ/010-L2	28			
6502905013	KIB-M18PS/005-KL6V	23	6503421704	KIN-T18AÖ/008-L2	26			
6502905022	KIB-M18PS/008-KL2E	24	6503435959	KIB-M30AÖ/010-LSD	29			
6502905023	KIB-M18PS/005-KL2PUT	24	6503503001	KIB-M12AS/002-L2	18			
6502906006	KIN-M18PS/008-KL2V	26	6503504001	KIN-M12AS/004-L2	20			
6502906009	KIB-M18PS/008-KS12V	25	6503505002	KIB-M18AS/005-L2	22			
6502906018	KIN-M18PS/016-KL2E	28	6503506002	KIN-M18AS/008-L2	25			
6502907003	KIB-M30PS/010-KL2V	28	6503507378	KIB-M30AS/010-L2	28			

Capacitive Sensors

1	2	3	4	5	6	7	8	9	10	11	12	13	14	15	16	17	18	19	+
K	C	N	-	T	1	2	N	S	/	0	0	4	-	K	L	P	2		
Product group			Type of enclosure				Output		Sensing distance				Options						

Product group		
1	K	Non-contact proximity switch
2	C	Capacitive
3	B	Flush mount
	N	Non-flush mount
4	-	Dash (fixed)
Type of enclosure		
5	M	Metric thread (metal enclosure)
	T	Metric thread (plastic enclosure)
	D	Round enclosure (metal)
	R	Round enclosure (plastic)
	Q	Cuboid enclosure (metal)
	P	PG thread (metal)
	E	Rectangular enclosure (plastic)
	N	Standard mounting (to DIN 50025/50037)
6-7		Two-digit number for:
		Round types = Ø as specified
		Threaded types = standard designation
		Rectangular types = consecutive type numbers

Design examples		
	12	Thread M12 x 1
	18	Thread M18 x 1
	30	Thread M30 x 1,5
	32	Thread M32 x 1,5
	34	Ø 34 mm (metal/plastic)
	20	Ø 20 mm (plastic)
	22	Ø 22 mm (plastic)
	50	50 x 25 x 10 mm
	68	68 x 30 x 15 mm
	44	41.5 x 41.5 x 120 mm (Euro standard enclosure)
Output		
8	p	PNP
	N	NPN
	A	AC 2-wire
	E	NAMUR
	Z	DC 2-wire
	R	Relay
	G	Push-pull
	D	Dual output stage (NPN/PNP selectable)

Output		
9	S	NO contact
	Ö	NC contact
	P	Programmable
	A	Analogue
	U	Antivalent (selectable)
10	/	Slash (fixed)
Sensing distance		
11-13	e.g. 1.5	1.5 mm
	e.g. 002	2.0 mm
	e.g. 040	40 mm
14	-	Dash (fixed)
Options		
15-19		See type code "OPTIONS", p. 173

Capacitive Sensors (sort by article number)

Art. No.	Type	Page		
6507013001	KCN-T32DP/030-KLP2	45		
6507013004	KCN-T32DP/030-KLPS12	45		
6507013012	KCB-M32GP/015-KLP2	45		
6507013013	KCB-M32DP/015-KLP6	45		
6507013015	KCB-M32DP/015-KLPS12	45		
6507303001	KCB-M12NS/002-KLP2	42		
6507305001	KCB-M18NS/005-KLP2	43		
6507315001	KCN-R34NS/030-KLP2	46		
6507319001	KCN-T12NS/004-KLP2	42		
6507321723	KCN-T18NS/008-KLP2	43		
6507323001	KCN-T30NS/020-KLP2	44		
6507390001	KCB-E50NS/008-KLP2	47		
6507703001	KCB-M12PÖ/002-KLP2	42		
6507707001	KCB-M30PÖ/010-KLP2	44		
6507821001	KCN-T18PU/008-KLP2V	43		
6507903001	KCB-M12PS/002-KLP2	42		
6507903004	KCB-M12PS/002-KLSM8	42		
6507905001	KCB-M18PS/005-KLP2	43		
6507905004	KCB-M18PS/005-KLPSM8	43		
6507907001	KCB-M30PS/010-KLP2	44		
6507907004	KCB-M30PS/010-KLPS12	44		
6507910001	KCN-R20PS/015-KLP2	46		
6507910004	KCN-R20PS/015-KLPSM8	46		
6507915001	KCN-R34PS/030-KLP2	46		
6507915004	KCN-R34PS/030-KLPS12	47		
6507915006	KCB-D34PS/020-KLPS12	46		
6507919001	KCN-T12PS/004-KLP2	42		
6507919004	KCN-T12PS/004-KLSM8	42		
6507921002	KCN-T18PS/008-KLPSM8	43		
6507921004	KCN-T18PS/013-KLPS12V	43		
6507921724	KCN-T18PS/008-KLP2	43		
6507923004	KCN-T30PS/020-KLPS12	44		
6507923006	KCN-T30PS/020-KLPS12V	44		
6507923727	KCN-T30PS/020-KLP2	44		
6507956001	KCB-E68PS/010-KLP2	47		
6507990001	KCB-E50PS/008-KLP2	47		
6508410001	KCN-R20AÖ/015-LP2	46		
6508415001	KCN-R34AÖ/030-LP2	47		
6508421001	KCN-T18AÖ/008-LP2	43		
6508423001	KCN-T30AÖ/020-LP2	44		
6508515001	KCN-R34AS/030-LP2	47		
6508521001	KCN-T18AS/008-LP2	43		
6508523001	KCN-T30AS/020-LP2	44		
6508613001	KCN-T32RU/030-LP2	45		
6607919110	KCN-T12PS/006-KLP2E	42		

Type Code

Optoelectronic Sensors

1	2	3	4	5	6	7	8	9	10	11	12	13	14	15	16	17	18	19	
O	M	1	2	R	T	-	D	H	T	P	-	0	2	0	0	-	C	L	
Product group		Enclosure size		Operating principle			Type of voltage	Output				Sensing range					Type of connection	Options	

Product group		
1	O	Optoelectronic sensor
2	M	Metric brass enclosure
	N	Metric stainless steel enclosure
	T	Metric thermoplastic enclosure
	R	Rectangular type
	Z	Cylindrical type
Enclosure size details		
3 – 4	e.g. 12	M12
	e.g. 18	M18
	e.g. 20	Type 20
Operating principle		
5 – 6	ES	Through-beam sensor assy (set)
	EE	Receiver, through-beam sensor
	SE	Transmitter, through-beam sensor
	LC	Fibre optic switching amplifier (light barrier with fibre optic cable connection)
	RH	Diffuse-reflection sensor with background suppression
	RS	Retro-reflective sensor
	RT	Diffuse –reflection sensor
	FF	Convergent beam sensor, fixed focus
	PS	Retro-reflective sensor, polarised
7	-	Dash (fixed)
Type of voltage		
8	A	AC
	D	DC
	M	Multi-voltage
	P	Programmable (AC or DC)

Output function		
9	A	Antivalent (light and dark activated)
	D	Dark activated
	H	Light activated
	O	No output (transmitter for through-beam sensors)
	P	Programmable (light and dark activated)
	X	Customer-specific output
Type of output		
10	A	Analogue output
	N	NAMUR
	O	No output
	Q	Triac
	R	Relay
	S	Other
	T	Transistor
	Y	Thyristor
11	N	NPN transistor output
	P	PNP transistor output
	G	Push-pull output stage
	S	Transmitter, through-beam sensor
	U	PNP/NPN selectable
	X	Customer-specific output
	2	2-wire output
	3	3-wire output
	4	4-wire output
12	-	Dash (fixed)

Sensing range		
13 – 16	The range and sensing distance are always a 4-digit specification – Millimetre values with no decimal point – Metre values with decimal point	
	e.g. 06.0	6 m
	e.g. 15.0	15 m
	e.g. 0500	500 mm
17	-	Dash (fixed)
Type of connection		
18	A	Connection space
	B	Self-configured cable connector
	C	Cable type (standard C = 2 m or length in m)
	S	Plug connector
Options		
19	C	Control input
	D	LED for switching status and operating reserve
	E	Adjustable sensitivity
	I	Electrically programmable
	F	Operating reserve output and LED
	G	LED for switching status, operating voltage indicator and light path monitoring
	H	LED for indicating operating voltage and switching status
	L	LED for switching status
	T	Adjustable time stage
	V	LED for indicating operating voltage
	W	Radial optical system
	X	Customer-specific option
	Z	Inbuilt time stage

Optoelectronic Sensors (sort by type designation)

Type	Art. No.	Page		
OM12RT-DHTP-0060-CL	6557928002	50		
OM18RT-DPTN-0500-CLE	6557217003	53		
OM18RT-DPTP-0300-SLE	6557816002	52		
OM18RT-DPTP-0500-CLE	6557817004	53		
OM18RT-DPTP-0500-SLE	6557816006	53		
ON18EE-DPTP-08.0-SL	6551821001	54		
ON18RT-DPTP-0300-SLE	6557821002	52		
ON18SE-DOOS-08.0-SCV	6551021001	54		
OR05EE-DATP-12.0-3DE	6551875003	58		
OR05PS-DATP-04.0-3DE	6555875001	58		
OR05PS-DHTP-04.0-3LFE	6555975002	58		
OR05RT-DATP-01.2-3DE	6557875003	57		
OR05RT-DHTP-01.2-SLFE	6557975003	58		
OR05SE-DOOS-12.0-3C	6551075003	58		
OR12EE-DDTP-01.0-SL	6551755002	56		
OR12EE-DDTP-01.0-SLE	6551755004	56		
OR12EE-DDTP-06.0-SL	6551755001	56		
OR12EE-DHTN-06.0-SL	6551355001	56		
OR12EE-DHTP-01.0-SL	6551955002	56		
OR12EE-DHTP-06.0-SL	6551955001	56		
OR12FF-DHTP-0050-SL	6558955001	57		
OR12RS-DDTP-04.0-SL	6554755001	57		
OR12RS-DHTP-04.0-SL	6554955001	57		
OR12RT-DHTP-01.2-SLE	6557955002	57		
OR12RT-DHTP-0200-SLE	6557955001	56		
OR12SE-DOOS-01.0-SVC	6551055003	56		
OR12SE-DOOS-06.0-SVC	6551055002	56		
OR15RT-DHTP-0040-SL	6557950006	59		
OR20EE-DPTP-20.0-ALET	6551886003	62		
OR20EE-MAR5-20.0-ALET	6551686004	62		
OR20PS-DPTP-06.0-ALET	6555886001	61		
OR20PS-MAR5-06.0-ALET	6555686002	61		
OR20RH-MAR5-0400-ALET	6558686002	60		
OR20RS-MAR5-08.0-ALET	6554686002	62		
OR20RT-DPTP-01.5-ALET	6557886003	60		
OR20RT-MAR5-01.5-ALET	6557686004	60		
OR20RT-MAR5-0600-ALET	6557686001	60		
OR20SE-DOOS-20.0-AV	6551086003	62		
OR20SE-MOOS-20.0-AV	6551086002	62		
OT12RT-DHTP-0060-CL	6557930002	50		
OT12RT-DHTP-0060-S	6557929002	50		
OT12SE-DOOS-06.0-S	6551029001	50		
OT18EE-DPTP-08.0-CL	6551819001	54		
OT18FF-DPTP-0040-CL	6558819001	51		
OT18FF-DPTP-0040-SL	6558818002	51		
OT18PS-DPTP-02.5-CLE	6555819003	53		
OT18PS-DPTP-02.5-SLE	6555818001	53		
OT18RT-DATN-0200-CEL	6557219002	52		
OT18RT-DATP-0200-CEL	6557819001	52		
OT18RT-DPTN-0300-SLE	6557218005	53		
OT18RT-DPTP-0100-CL	6557819004	51		
OT18RT-DPTP-0100-SL	6557818002	51		
OT18RT-DPTP-0300-CLE	6557819005	52		
OT18RT-DPTP-0300-SLE	6557818003	53		
OT18RT-DPTP-0500-CLE	6557819006	53		
OT18RT-DPTP-0500-SLE	6557818006	53		
OT18SE-DOOS-08.0-CCV	6551019001	54		
OT30RT-DDAP-0500-CE	6557005006	54		
OT30RT-DHTP-0200-6LE	6557905008	54		
OZ20RT-DPAP-0200-SE	6557000001	62		

Optoelectronic Sensors (sort by article number)

Art. No.	Type	Page		
6551019001	OT18SE-DOOS-08.0-CCV	54		
6551021001	ON18SE-DOOS-08.0-SCV	54		
6551029001	OT12SE-DOOS-06.0-S	50		
6551055002	OR12SE-DOOS-06.0-SVC	56		
6551055003	OR12SE-DOOS-01.0-SVC	56		
6551075003	OR05SE-DOOS-12.0-3C	58		
6551086002	OR20SE-MOOS-20.0-AV	62		
6551086003	OR20SE-DOOS-20.0-AV	62		
6551355001	OR12EE-DHTN-06.0-SL	56		
6551686004	OR20EE-MAR5-20.0-ALET	62		
6551755001	OR12EE-DDTP-06.0-SL	56		
6551755002	OR12EE-DDTP-01.0-SL	56		
6551755004	OR12EE-DDTP-01.0-SLE	56		
6551819001	OT18EE-DPTP-08.0-CL	54		
6551821001	ON18EE-DPTP-08.0-SL	54		
6551875003	OR05EE-DATP-12.0-3DE	58		
6551886003	OR20EE-DPTP-20.0-ALET	62		
6551955001	OR12EE-DHTP-06.0-SL	56		
6551955002	OR12EE-DHTP-01.0-SL	56		
6554686002	OR20RS-MAR5-08.0-ALET	62		
6554755001	OR12RS-DDTP-04.0-SL	57		
6554955001	OR12RS-DHTP-04.0-SL	57		
6555686002	OR20PS-MAR5-06.0-ALET	61		
6555818001	OT18PS-DPTP-02.5-SLE	53		
6555819003	OT18PS-DPTP-02.5-CLE	53		
6555875001	OR05PS-DATP-04.0-3DE	58		
6555886001	OR20PS-DPTP-06.0-ALET	61		
6555975002	OR05PS-DHTP-04.0-3LFE	58		
6557000001	OZ20RT-DPAP-0200-SE	62		
6557005006	OT30RT-DDAP-0500-CE	54		
6557217003	OM18RT-DPTN-0500-CLE	53		
6557218005	OT18RT-DPTN-0300-SLE	53		
6557219002	OT18RT-DATN-0200-CEL	52		
6557686001	OR20RT-MAR5-0600-ALET	60		
6557686004	OR20RT-MAR5-01.5-ALET	60		
6557816002	OM18RT-DPTP-0300-SLE	52		
6557816006	OM18RT-DPTP-0500-SLE	53		
6557817004	OM18RT-DPTP-0500-CLE	53		
6557818002	OT18RT-DPTP-0100-SL	51		
6557818003	OT18RT-DPTP-0300-SLE	53		
6557818006	OT18RT-DPTP-0500-SLE	53		
6557819001	OT18RT-DATP-0200-CEL	52		
6557819004	OT18RT-DPTP-0100-CL	51		
6557819005	OT18RT-DPTP-0300-CLE	52		
6557819006	OT18RT-DPTP-0500-CLE	53		
6557821002	ON18RT-DPTP-0300-SLE	52		
6557875003	OR05RT-DATP-01.2-3DE	57		
6557886003	OR20RT-DPTP-01.5-ALET	60		
6557905008	OT30RT-DHTP-0200-6LE	54		
6557928002	OM12RT-DHTP-0060-CL	50		
6557929002	OT12RT-DHTP-0060-S	50		
6557930002	OT12RT-DHTP-0060-CL	50		
6557950006	OR15RT-DHTP-0040-SL	59		
6557955001	OR12RT-DHTP-0200-SLE	56		
6557955002	OR12RT-DHTP-01.2-SLE	57		
6557975003	OR05RT-DHTP-01.2-SLFE	58		
6558686002	OR20RH-MAR5-0400-ALET	60		
6558818002	OT18FF-DPTP-0040-SL	51		
6558819001	OT18FF-DPTP-0040-CL	51		
6558955001	OR12FF-DHTP-0050-SL	57		

Magnetic Switches

1	2	3	4	5	6	7	8	9	10	11	12	13	14	15	16	17		
M	A	K	-	0	1	1	2	-	D	-	1	-	S	O	K			
Product group			Type			Contact specifications				Cable length			Special features					

Product group		
1	M	Magnetic switch
2	Type of output	
	A	Reed contact
	R	Relay
3	Enclosure material	
	A	Aluminium
	N	Stainless steel
	M	Brass, nickel-plated
	K	Plastic, general
	O	Other materials
4	-	Dash (fixed)
Type		
5 – 6	01 – 99	Cylindrical and rectangular types (see next page for details)
Contact specifications		
7	Number of contacts	
	e.g. 1	1 Reed contact
	e.g. 2	2 Reed contacts
	...	etc.

8	Contact function	
	1	NC contact
	2	NO contact
	3	Changeover contact
	4	Bistable (ON/OFF)
	5	Bistable (changeover contact)
	6	NC, NO contact; separate contacts
	7	Coded, BG
	8	Currently not used
	9	Currently not used
	0	Other outputs
9	-	Dash (fixed)
10	Contact type/power of reed contacts	
	A	250 VDC ; 0.5 A; 20 VA
	B	250 VDC ; 0.5 A; 10 VA
	C	250 VDC ; 0.5 A; 30 VA
	D	250 VDC ; 0.5 A; 30 VA
	E	250 VDC ; 1.5 A; 30 VA
	F	250 VDC ; 3.0 A; 100 VA
	G	250 VDC ; 5.0 A; 250 VA
	H	250 VDC ; 1.0 A; 60 VA
	K	250 VDC ; 0.5 A; 30 VA
	L	250 VDC ; 1.0 A; 60 VA
	M	250 VDC ; 1.0 A; 80 VA
	N	250 VDC ; 1.0 A; 60 VA
	O	120 VDC ; 0.5 A; 10 VA
	P	250 VDC ; 5.0 A; 250 VA
	R	28 VDC ; 0.25 A; 3 VA
	W	250 VDC ; 1.0 A; 60 VA
	X	100 VDC ; 0.25 A; 5 VA
	Y	100 VDC ; 0.5 A; 10 VA

TRIAC		
	K	24 – 250 VDC ; 1.5 A a. 300 VA b. 330 VA
	Hall	
11	-	Dash (fixed)
Cable length in metres		
12	e.g. 1	1 m cable
	e.g. 2	2 m cable
	...	etc.
13	-	Dash (fixed)
Special features		
14 – 17	T	Temperature resistant from –40 °C to +150 °C
	SI	With miniature fuse
	VDR	With VDR
	WID	With resistor
	LED	With LED
	SPK	Spiral cable
	SK	Special cable
	SOK	Connector type without head (without device socket)
	SMK	Connector type with head (with device socket)
	PG11	Type of thread
	RZ	Time delay with relay
	220 V	220 Volt version
	24 V	24 Volt version
	STK	Connector

Type Code

Magnetic Switches

1	2	3	4	5	6	7	8	9	10	11	12	13	14	15	16	17		
M	A	K	-	0	1	1	2	-	D	-	1	-	S	O	K			
Product group			Type			Contact specifications				Cable length			Special features					

Type		
5-6	01-99	Cylindrical and rectangular types
	01	45 x 13 x 9 mm [MA-01] PA
	02	80 x 20 x 15 mm [MA-02] PA/AL
	03	110 x 58 x 29 mm [MA-03] AL
	04	∅ 15.5 x 87 mm [MA-04] PC
	05	Currently not used
	06	∅ 12 x 81 mm [MA-06] AL
	07-10	Currently not used
	11	28.6 x 18 x 6.4 mm [MA-11] PA
	12	80 x 20 x 15 mm [MA-12] PA
	13	68 x 30 x 15 mm [MA-13] PC
	14	Currently not used
	15	∅ 12 x 81 mm [MA-15] PA
	16	∅ 12 x 81 mm [MA-13] VA
	17	PG9 x 60 mm [MA-17] PA
	18	M12 x 1 x 60 mm [MA-18] Ms
	19	M18 x 1 x 80 mm [MA-19] Ms
	20	Currently not used
	21	PG9 x 80 mm [MA-21] PA
	22	Currently not used
	23	M12 x 1 x 80 mm [MA-23] Ms
	24/25	Currently not used
	26	∅ 12 x 81 mm [MA-26] PA
	27	Currently not used
	28	M12 x 1 x 60 mm [MA-28] PA
	29	M18 x 1 x 80 mm [MA-29] PA
	30	∅ 6 x 30 mm [MA-30] PA
	31	Currently not used
	32	85 x 26 x 26 mm [MA-32] PBT
	33	M12 x 1 x 80 mm [MA-33] PA
	34/35	Currently not used

	36	∅ 13 x 96 mm [MA-36] PA
	37-39	Currently not used
	40	M10 x 1 x 40 mm [MA-40] PPE
	41	50 x 31 x 11 mm [MA-41] PA
	42	88 x 25 x 13 mm [MA-42] PA
	43	PG9 x 80 mm [MA-43] Ms
	44	80 x 30 x 15 mm [MA-44] PA
	45	45 x 25.5 x 9 mm [MA-45] PA
	46	∅ 6.5 x 39.34 mm [MA-46] PA
	47	Currently not used
	48	80 x 30 x 15 mm [MA-48] PA
	49-51	Currently not used
	52	43 x 26 x 13 mm [MA-52] PBT
	53	M30 x 1.5 mm [MA-53] PA
	54	Currently not used
	55	12 x 12 x 55 mm [MA-55] S
	56-59	Currently not used
	60	M8 x 1 mm [MA-60] S
	61	M10 x 1 mm [MA-61] S
	62	M12 x 1 mm [MA-62] S
	63	M18 x 1 mm [MA-63] S
	64	M30 x 1.5 mm [MA-64] S
	65-69	Currently not used
	70	∅ 6.5 mm [MA-70] S
	71/72	Currently not used
	73	68 x 30 x 15 mm [MA-73] S
	74-79	Currently not used
	80	8 x 8 x 40 mm [MA-80] S
	81-98	Currently not used
	99	other [MA-99] S

Magnetic Switch Monitoring Devices

1	2	3	4	5	6	7	8	9	10	11	12	13	14	15	16	17	18	19	20	21	22	23	24
M	Ü	Z	-	1	0	2	/	U	2	4	-	F	L	-	2	S	-	E	2	0	-	H	G
Product group			Numb. of magnetic switches	Number of relays			Voltage			Special features													

Product group		
1	M	Magnetic limit switch, general
2	Ü	Monitoring
	C	Controller
3	Z	Control station
	S	Interface
	N	Power supply unit
4	-	Dash (fixed)
Number of connectable magnetic switches		
5	1	1 unit
	2	2 units
	...	etc.
Number of relays		
6 - 7	01	1 unit
	02	2 units
	03	Constant current source
	04	4 units
	...	etc.
8	/	Slash (fixed)

Voltage		
9	A	AC
	D	DC
	U	UC
	1	Mains voltage
	2	Mains voltage
10 - 11	24	24 Volt
	The following applies when there is a "1" in the 9 th position:	
	10	110 Volt
	20	120 Volt
	30	130 Volt
	The following applies when there is a "2" in the 9 th position:	
	10	210 Volt
	20	220 Volt
	30	230 Volt

Special features		
13 - 24	FL	Flat design
	2S	NO contact signal (to outside)
	E20	20 transducer units, externally
	HG	Hall sensor
	VC	Voltage control
	PRT	Print version
	DA	Data output
	Special features are separated by a dash with no specific position assignment.	

Magnetic Switches / Slot Sensors with Reed Contact (sort by type designation)

Type	Art. No.	Page	Type	Art. No.	Page
MAA-0213-LT-1	6316302389	74	MAM-1813-L-1	6316318002	70
MAA-0213-STK	6310302636	74	MAM-2312-F-1	6314223268	70
MAA-0214-FT-3	6314402566	72	MAM-3114-2-LED	6310431569	71
MAA-0312-F	6314203232	75	MAM-4313-L-2	6316343544	71
MAA-0313-M	6317303312	75	MAN-0812-B-1	6311208596	70
MAA-0314-P	6319403532	75	MAN-0813-STK	6310308595	70
MAA-0612-D-1	6312206321	68	MAN-0813-Y-1	6310308597	70
MAA-0612-F-1	6314206246	68	MAN-1612-F-3	6314216476	68
MAA-0612-NT-4	6410206399	69	MAN-1612-FT-8	6314216585	68
MAA-0613-K-1	6315306314	68	MAN-1613-L-1	6316316259	68
MAA-0613-L-1	6316306248	69			
MAA-0613-LT-1	6316306004	69			
MAA-0613-M-1	6317306315	68			
MAA-0614-P-1	6310406554	69			
MAA-E30S/R20-0,3S8	6310299746	88			
MAA-E30S/R20-2	6310299745	88			
MAK-0112-B-2	6311201095	72			
MAK-0212-D-1	6312202316	73			
MAK-0212-F-1	6314202204	73			
MAK-0213-K-1	6315302309	72			
MAK-0213-L-1	6316302206	73			
MAK-0214-P-3	6419402397	72			
MAK-0413-M-5	6317304313	70			
MAK-1112-B-1	6311211541	72			
MAK-1113-1	6310311615	71			
MAK-1113-1,5	6410311368	71			
MAK-1114-B-5	6311411603	72			
MAK-1212-F-1	6314212217	73			
MAK-1213-K-1	6315312196	72			
MAK-1213-L-1	6316312220	73			
MAK-1214-L-2	6410412143	73			
MAK-1313-L-1	6316313004	72			
MAK-2612-F-1	6314226423	68			
MAK-2613-K-1	6315326425	69			
MAK-2613-L-1	6316326426	69			
MAK-2812-L-3	6416228260	70			
MAK-3012-B-1	6311230571	68			
MAK-3013-X-1	6310330572	68			
MAK-3214-F-3	6314432609	74			
MAK-3214-P-1	6310432598	74			
MAK-3214-P-STK4.8	6310432590	74			
MAK-3312-F-2	6314233002	70			
MAK-3313-L-1	6316333005	70			
MAK-3314-P-2	6410433350	71			
MAK-3611-P-1	6310136616	69			
MAK-3615-L-1	6310536617	69			
MAK-4212-F-1	6314242533	74			
MAK-4213-M-1	6317342535	74			
MAK-4214-P-1	6310442534	75			
MAK-4214-P-3	6310442622	75			
MAK-4411-F-1	6314144542	74			
MAK-4412-F-1	6314244536	74			
MAK-4413-M-1	6317344538	74			
MAK-4414-P-1	6310444537	74			
MAK-4512-B-1	6311245539	72			
MAK-4513-L-1	6316345540	72			
MAK-4612-A-2	6310246500	68			
MAK-E22S/R20-0,3S8	6310281742	88			
MAK-E22S/R20-0,3S8	6310281744	88			
MAK-E22S/R20-2	6310281741	88			
MAK-E22S/R20-2	6310281743	88			
MAM-1811-2	6310118626	71			
MAM-1812-B-1	6311218294	70			

Magnetic Switches / Slot Sensors with Reed Contact (sort by article number)

Art. No.	Type	Page	Art. No.	Type	Page	
6310118626	MAM-1811-2	71	6317306315	MAA-0613-M-1	68	
6310136616	MAK-3611-P-1	69	6317342535	MAK-4213-M-1	74	
6310246500	MAK-4612-A-2	68	6317344538	MAK-4413-M-1	74	
6310281741	MAK-E22S/R20-2	88	6319403532	MAA-0314-P	75	
6310281742	MAK-E22S/R20-0,3S8	88	6410206399	MAA-0612-NT-4	69	
6310281743	MAK-E22S/R20-2	88	6410311368	MAK-1113-1,5	71	
6310281744	MAK-E22S/R20-0,3S8	88	6410412143	MAK-1214-L-2	73	
6310299745	MAA-E30S/R20-2	88	6410433350	MAK-3314-P-2	71	
6310299746	MAA-E30S/R20-0,3S8	88	6416228260	MAK-2812-L-3	70	
6310302636	MAA-0213-STK	74	6419402397	MAK-0214-P-3	72	
6310308595	MAN-0813-STK	70				
6310308597	MAN-0813-Y-1	70				
6310311615	MAK-1113-1	71				
6310330572	MAK-3013-X-1	68				
6310406554	MAA-0614-P-1	69				
6310431569	MAM-3114-2-LED	71				
6310432590	MAK-3214-P-STK4.8	74				
6310432598	MAK-3214-P-1	74				
6310442534	MAK-4214-P-1	75				
6310442622	MAK-4214-P-3	75				
6310444537	MAK-4414-P-1	74				
6310536617	MAK-3615-L-1	69				
6311201095	MAK-0112-B-2	72				
6311208596	MAN-0812-B-1	70				
6311211541	MAK-1112-B-1	72				
6311218294	MAM-1812-B-1	70				
6311230571	MAK-3012-B-1	68				
6311245539	MAK-4512-B-1	72				
6311411603	MAK-1114-B-5	72				
6312202316	MAK-0212-D-1	73				
6312206321	MAA-0612-D-1	68				
6314144542	MAK-4411-F-1	74				
6314202204	MAK-0212-F-1	73				
6314203232	MAA-0312-F	75				
6314206246	MAA-0612-F-1	68				
6314212217	MAK-1212-F-1	73				
6314216476	MAN-1612-F-3	68				
6314216585	MAN-1612-FT-8	68				
6314223268	MAM-2312-F-1	70				
6314226423	MAK-2612-F-1	68				
6314233002	MAK-3312-F-2	70				
6314242533	MAK-4212-F-1	74				
6314244536	MAK-4412-F-1	74				
6314402566	MAA-0214-FT-3	72				
6314432609	MAK-3214-F-3	74				
6315302309	MAK-0213-K-1	72				
6315306314	MAA-0613-K-1	68				
6315312196	MAK-1213-K-1	72				
6315326425	MAK-2613-K-1	69				
6316302206	MAK-0213-L-1	73				
6316302389	MAA-0213-LT-1	74				
6316306004	MAA-0613-LT-1	69				
6316306248	MAA-0613-L-1	69				
6316312220	MAK-1213-L-1	73				
6316313004	MAK-1313-L-1	72				
6316316259	MAN-1613-L-1	68				
6316318002	MAM-1813-L-1	70				
6316326426	MAK-2613-L-1	69				
6316333005	MAK-3313-L-1	70				
6316343544	MAM-4313-L-2	71				
6316345540	MAK-4513-L-1	72				
6317303312	MAA-0313-M	75				
6317304313	MAK-0413-M-S	70				

Magnetic Sensors / Teachable Slot Sensors / Electronic

1	2	3	4	5	6	7	8	9	10	11	12	13	14	15					
M	E	K	-	M	1	2	P	S	/	H	1	0	-	K	L	2			
Product group			Type of enclosure			Output			Sensitivity			Options							

Product group		
1	M	Magnetic sensor
2	E	Electronic
3	K	Plastic
	M	Brass
	N	Stainless steel
4	-	Dash (fixed)
Type of enclosure		
5	M	Metric thread
	D	Round enclosure
	E	Rectangular enclosure
	Q	Cuboid enclosure
6 – 7		Two-digit number for:
		Metric enclosure = standard designation
		Round enclosure = Ø as specified
		Rectangular enclosure = enclosure width
		Cuboid enclosure = edge length

Output		
8	P	PNP
	N	NPN
9	S	NO contact
	Ö	NC contact
	B	Bistable
	A	Analogue
	D	Speed
10	/	Slash (fixed)
Sensitivity		
11	H	Hall
	M	Magnetoiresistive
12 – 13		Sensitivity in mT
	z. B. 10	10 mT
	z. B. 01	1 mT
14	-	Dash (fixed)
Options		
15		See type code "OPTIONS", see page 173

Magnetic Sensors / Teachable Slot Sensors / Electronic (sort by type designation)

Type	Art. No.	Page	Type	Art. No.	Page
MEA-E30A10/H50-KL0,3S8	6370099169	86	MEM-M12NB/H11-K2	6363862035	79
MEA-E30PS/H03-KL0,3S8	6372299176	87	MEM-M12ND/H-K2	6369662028	81
MEA-E30PS/H03-KL2	6372299175	87	MEM-M12NS/H10-K2	6362662004	79
MEA-E30PS/HP1-KL0,3S8	6372299182	86	MEM-M12PB/H11-KL2	6373462126	80
MEA-E30PS/HP1-KL2	6372299181	86	MEM-M12PD/H-KL2	6379262120	81
MEA-E30PS/HP2-KL0,3S8	6370299188	86	MEM-M12PÖ/H10-KL2	6372162092	80
MEA-E30PS/HP2-KL2	6370299187	86	MEM-M12PÖ/M01-KL2	6373162096	80
MEK-E-22A10/H50-KL0,3S8	6370081168	86	MEM-M12PS/H10-KL10	6472262077	80
MEK-E-22A10/H50-KL0,3S8	6370081170	86	MEM-M12PS/H10-KL2	6372262090	80
MEK-E27NB/H02-K2	6363893031	83	MEM-M12PS/M01-KL2	6373262094	80
MEK-E22PS/H03-KL0,3S8	6372281172	87	MEM-M12PS/M01-KL5	6373262123	80
MEK-E22PS/H03-KL0,3S8	6372281174	87	MEM-M18NB/H11-K2	6363863037	81
MEK-E22PS/H03-KL2	6372281171	87	MEM-M18NS/H10-K2	6362663006	81
MEK-E22PS/H03-KL2	6372281173	87	MEM-M18PB/H11-KL2	6373463128	81
MEK-E22PS/HP1-KL0,3S8	6372281178	86	MEM-M18PD/H-KL2	6379263122	82
MEK-E22PS/HP1-KL0,3S8	6372281180	86	MEM-M18PÖ/H10-KL2	6372163100	81
MEK-E22PS/HP1-KL2	6372281177	86	MEM-M18PÖ/M01-KL2	6373163104	82
MEK-E22PS/HP1-KL2	6372281179	86	MEM-M18PS/H10-KL2	6372263098	81
MEK-E22PS/HP2-KL0,3S8	6370281184	86	MEM-M18PS/M01-KL2	6373263102	82
MEK-E22PS/HP2-KL0,3S8	6370281186	86	MEM-Q05PS/M03-K2	6373299134	82
MEK-E22PS/HP2-KL2	6370281183	86	MEM-Q08NB/H11-K2	6363880043	83
MEK-E22PS/HP2-KL2	6370281185	86	MEM-Q08NS/H10-K2	6362680012	83
MEK-E27NB/H11-K2	6363893041	83	MEM-Q08PS/M02-K2	6373280106	83
MEK-E27NS/H10-K2	6362693010	83	MEM-Q12NB/H11-K2	6363855044	83
MEK-E29NB/H11-K2	6363811039	83	MEM-Q12NS/H10-K2	6362655013	83
MEK-E29NS/H10-K2	6362611008	83	MEM-Q12PB/H11-KL2	6373455131	83
MEK-E45NB/H11-K2	6363845040	84	MEM-Q12PÖ/H10-KL2	6372155084	83
MEK-E45NS/H10-K2	6362645009	84	MEM-Q12PS/H10-KL2	6372255083	83
MEK-E45PB/H11-KL2	6373445129	84	MEN-D04PS/M03-K2	6373299132	78
MEK-E45PÖ/H10-KL2	6372145080	84	MEN-D06NB/H11-K2	6363870032	78
MEK-E45PS/H10-KL2	6372245079	84	MEN-D06NS/H10-K2	6362670001	78
MEK-E50NB/H11-K2	6363890042	84	MEN-D06PS/M02-K2	6373270105	78
MEK-E50NS/H10-K2	6362690011	84			
MEK-E50PB/H11-KL2	6373490130	84			
MEK-E50PÖ/H10-KL2	6372190082	84			
MEK-E50PS/H10-KL2	6372290081	84			
MEK-M12NB/H11-K2	6363862036	79			
MEK-M12ND/H-K2	6369662027	81			
MEK-M12NS/H10-K2	6362662005	79			
MEK-M12PB/H11-KL2	6373462125	80			
MEK-M12PD/H-KL2	6379262119	81			
MEK-M12PÖ/H10-KL2	6372162091	80			
MEK-M12PÖ/M01-KL2	6373162095	80			
MEK-M12PS/H10-KL2	6372262089	80			
MEK-M12PS/M01-KL2	6373262093	80			
MEK-M18NB/H11-K2	6363863038	81			
MEK-M18NS/H10-K2	6362663007	81			
MEK-M18PB/H11-KL2	6373463127	81			
MEK-M18PD/H-KL2	6379263121	82			
MEK-M18PÖ/H10-KL2	6372163099	81			
MEK-M18PÖ/M01-KL2	6373163103	82			
MEK-M18PS/H10-KL2	6372263097	81			
MEK-M18PS/M01-KL2	6373263101	82			
MEM-M05PS/M03-K2	6373299133	78			
MEM-M08NB/H11-K2	6363860033	79			
MEM-M08NS/H10-K2	6362660002	79			
MEM-M08PS/M02-K2	6373260107	79			
MEM-M10NB/H11-K2	6363861034	79			
MEM-M10NS/H10-K2	6362661003	79			
MEM-M10PB/H11-KL2	6373461124	79			
MEM-M10PÖ/H10-KL2	6372161086	79			
MEM-M10PÖ/M01-KL2	6373161088	79			
MEM-M10PS/H10-KL2	6372261085	79			
MEM-M10PS/M01-KL2	6373261087	79			

Magnetic Sensors / Teachable Slot Sensors / Electronic (sort by article number)

Art. No.	Type	Page	Art. No.	Type	Page
6362611008	MEK-E29NS/H10-K2	83	6372299181	MEA-E30PS/HP1-KL2	86
6362645009	MEK-E45NS/H10-K2	84	6372299182	MEA-E30PS/HP1-KL0,3S8	86
6362655013	MEM-Q12NS/H10-K2	83	6373161088	MEM-M10PÖ/M01-KL2	79
6362660002	MEM-M08NS/H10-K2	79	6373162095	MEK-M12PÖ/M01-KL2	80
6362661003	MEM-M10NS/H10-K2	79	6373162096	MEM-M12PÖ/M01-KL2	80
6362662004	MEM-M12NS/H10-K2	79	6373163103	MEK-M18PÖ/M01-KL2	82
6362662005	MEK-M12NS/H10-K2	79	6373163104	MEM-M18PÖ/M01-KL2	82
6362663006	MEM-M18NS/H10-K2	81	6373260107	MEM-M08PS/M02-K2	79
6362663007	MEK-M18NS/H10-K2	81	6373261087	MEM-M10PS/M01-KL2	79
6362670001	MEN-D06NS/H10-K2	78	6373262093	MEK-M12PS/M01-KL2	80
6362680012	MEM-Q08NS/H10-K2	83	6373262094	MEM-M12PS/M01-KL2	80
6362690011	MEK-E50NS/H10-K2	84	6373262123	MEM-M12PS/M01-KL5	80
6362693010	MEK-E27NS/H10-K2	83	6373263101	MEK-M18PS/M01-KL2	82
6363811039	MEK-E29NB/H11-K2	83	6373263102	MEM-M18PS/M01-KL2	82
6363845040	MEK-E45NB/H11-K2	84	6373270105	MEN-D06PS/M02-K2	78
6363855044	MEM-Q12NB/H11-K2	83	6373280106	MEM-Q08PS/M02-K2	83
6363860033	MEM-M08NB/H11-K2	79	6373299132	MEN-D04PS/M03-K2	78
6363861034	MEM-M10NB/H11-K2	79	6373299133	MEM-M05PS/M03-K2	78
6363862035	MEM-M12NB/H11-K2	79	6373299134	MEM-Q05PS/M03-K2	82
6363862036	MEK-M12NB/H11-K2	79	6373445129	MEK-E45PB/H11-KL2	84
6363863037	MEM-M18NB/H11-K2	81	6373455131	MEM-Q12PB/H11-KL2	83
6363863038	MEK-M18NB/H11-K2	81	6373461124	MEM-M10PB/H11-KL2	79
6363870032	MEN-D06NB/H11-K2	78	6373462125	MEK-M12PB/H11-KL2	80
6363880043	MEM-Q08NB/H11-K2	83	6373462126	MEM-M12PB/H11-KL2	80
6363890042	MEK-E50NB/H11-K2	84	6373463127	MEK-M18PB/H11-KL2	81
6363893031	MEK-E27NB/H02-K2	83	6373463128	MEM-M18PB/H11-KL2	81
6363893041	MEK-E27NB/H11-K2	83	6373490130	MEK-E50PB/H11-KL2	84
6369662027	MEK-M12ND/H-K2	81	6379262119	MEK-M12PD/H-KL2	81
6369662028	MEM-M12ND/H-K2	81	6379262120	MEM-M12PD/H-KL2	81
6370081168	MEK-E-22A10/H50-KL0,3S8	86	6379263121	MEK-M18PD/H-KL2	82
6370099169	MEA-E30A10/H50-KL0,3S8	86	6379263122	MEM-M18PD/H-KL2	82
6370081170	MEK-E22A10/H50-KL0,3S8	86	6472262077	MEM-M12PS/H10-KL10	80
6370281183	MEK-E22PS/HP2-KL2	86			
6370281184	MEK-E22PS/HP2-KL0,3S8	86			
6370281185	MEK-E22PS/HP2-KL2	86			
6370281186	MEK-E22PS/HP2-KL0,3S8	86			
6370299187	MEA-E30PS/HP2-KL2	86			
6370299188	MEA-E30PS/HP2-KL0,3S8	86			
6372145080	MEK-E45PÖ/H10-KL2	84			
6372155084	MEM-Q12PÖ/H10-KL2	83			
6372161086	MEM-M10PÖ/H10-KL2	79			
6372162091	MEK-M12PÖ/H10-KL2	80			
6372162092	MEM-M12PÖ/H10-KL2	80			
6372163099	MEK-M18PÖ/H10-KL2	81			
6372163100	MEM-M18PÖ/H10-KL2	81			
6372190082	MEK-E50PÖ/H10-KL2	84			
6372245079	MEK-E45PS/H10-KL2	84			
6372255083	MEM-Q12PS/H10-KL2	83			
6372261085	MEM-M10PS/H10-KL2	79			
6372262089	MEK-M12PS/H10-KL2	80			
6372262090	MEM-M12PS/H10-KL2	80			
6372263097	MEK-M18PS/H10-KL2	81			
6372263098	MEM-M18PS/H10-KL2	81			
6372281171	MEK-E22PS/H03-KL2	87			
6372281172	MEK-E22PS/H03-KL0,3S8	87			
6372281173	MEK-E22PS/H03-KL2	87			
6372281174	MEK-E22PS/H03-KL0,3S8	87			
6372281177	MEK-E22PS/HP1-KL2	86			
6372281178	MEK-E22PS/HP1-KL0,3S8	86			
6372281179	MEK-E22PS/HP1-KL2	86			
6372281180	MEK-E22PS/HP1-KL0,3S8	86			
6372290081	MEK-E50PS/H10-KL2	84			
6372299175	MEA-E30PS/H03-KL2	87			
6372299176	MEA-E30PS/H03-KL0,3S8	87			

Ultrasonic Sensors

1	2	3	4	5	6	7	8	9	10	11	12	13	14	15	16	17	18	19	20
U	T	1	8	I	-	D	P	E	0	-	0	6	.	0	-	C	3	I	
Product group		Enclosure size		Installation/use		Type of voltage	Output				Range					Type of connection	Teach-in	Interface	Options

Product group		
1		Ultrasonic sensor
2	T	Thermoplastic enclosure
	N	Stainless steel enclosure
Enclosure size details		
3 - 4	e.g. 12	M12 (stainless steel)
	e.g. 15	M30 (stainless steel)
	e.g. 18	M18 (stainless steel)
	e.g. 30	M30 (plastic)
	e.g. 25	30 x 25 x 11 (plastic)
	e.g. 80	80 x 80 x 43 (plastic)
	e.g. 36	101 x 36 x 22 (plastic)
Installation/use		
5	I	Internal transductor
	S	True scan transmitter and receiver
6	-	Dash (fixed)
Type of voltage		
7	A	AC
	D	DC 12-30V

Digital output		
8	0	None
	P	PNP
	N	NPN
9	0	None
	E	Electrically programmable NC/NO
	...	etc.
Analogue output		
10	0	None
	I	Current - analogue
	U	Voltage - analogue
11	-	Dash (fixed)
Range		
12 - 15	The range and sensing distance are always a 4-digit specification - Millimetre values with no decimal point - Metre values with decimal point	
	e.g. 06.0	6 m
	e.g. 15.0	15 m
	e.g. 0500	500 mm
16	-	Dash (fixed)

Type of connection		
17	C	Cable type (standard C = 2 m or length in m)
	S	Connector (M12, 5-pin)
	V	Connector (M8, 4-pin)
	B	Connector (M16, 8-pin)
Teach-in method		
18	0	None
	1	Button
	2	Serial interface
	3	Contact
	...	etc.
Serial interface		
19	0	None
	1	RS232
	2	RS485
	3	I/O link
	4	CANopen
	...	etc.
Options		
20 onwards	e.g.	Preset switching points
	...	etc.

Type Code

Ultrasonic Sensors (sort by type designation)

Type	Art. No.	Page		
UN12I-DNE0-0200-S30	6712201001	100		
UN12I-DPE0-0200-S30	6712101001	100		
UT18I-D00I-01.6-C30	6711302002	101		
UT18I-D00I-01.6-S30	6712302002	101		
UT18I-D00I-02.0-C30	6711302001	102		
UT18I-D00I-02.0-S30	6712302001	103		
UT18I-D00I-0400-C30	6711302005	100		
UT18I-D00I-0400-S30	6712302005	100		
UT18I-D00I-0500-C30	6711302004	101		
UT18I-D00I-0500-S30	6712302004	101		
UT18I-D00I-0800-C30	6711302003	102		
UT18I-D00I-0800-S30	6712302003	102		
UT18I-D00U-01.6-C30	6711402002	101		
UT18I-D00U-01.6-S30	6712402002	101		
UT18I-D00U-02.0-C30	6711402001	102		
UT18I-D00U-02.0-S30	6712402001	103		
UT18I-D00U-0400-C30	6711402005	100		
UT18I-D00U-0400-S30	6712402005	100		
UT18I-D00U-0500-C30	6711402004	101		
UT18I-D00U-0500-S30	6712402004	101		
UT18I-D00U-0800-C30	6711402003	102		
UT18I-D00U-0800-S30	6712402003	102		
UT18I-DNE0-01.6-C30	6711202002	101		
UT18I-DNE0-01.6-S30	6712202002	101		
UT18I-DNE0-02.0-C30	6711202001	102		
UT18I-DNE0-02.0-S30	6712202001	103		
UT18I-DNE0-0400-C30	6711202005	100		
UT18I-DNE0-0400-S30	6712202005	100		
UT18I-DNE0-0500-C30	6711202004	101		
UT18I-DNE0-0500-S30	6712202004	101		
UT18I-DNE0-0800-C30	6711202003	102		
UT18I-DNE0-0800-S30	6712202003	102		
UT18I-DPE0-01.6-C30	6711102002	101		
UT18I-DPE0-01.6-S30	6712102002	101		
UT18I-DPE0-02.0-C30	6711102001	102		
UT18I-DPE0-02.0-S30	6712102001	103		
UT18I-DPE0-0400-C30	6711102005	100		
UT18I-DPE0-0400-S30	6712102005	100		
UT18I-DPE0-0500-C30	6711102004	101		
UT18I-DPE0-0500-S30	6712102004	101		
UT18I-DPE0-0800-C30	6711102003	102		
UT18I-DPE0-0800-S30	6712102003	102		
UT25I-D00U-0250-V30	6713411001	104		
UT25I-DNE0-0250-V30	6713211001	104		
UT25I-DPE0-0250-V30	6713111001	104		
UT30I-D00I-03.5-C30	6711303001	103		
UT30I-D00I-03.5-S30	6712303001	103		
UT30I-D00U-03.5-C30	6711403001	103		
UT30I-DNE0-03.5-C30	6711203001	103		
UT30I-DNE0-03.5-S30	6712203001	103		
UT30I-DPE0-03.5-C30	6711103001	103		
UT30I-DPE0-03.5-S30	6712103001	103		
UT80I-D00I-06.0-S30	6712312001	104		
UT80I-D00U-06.0-S30	6712412001	104		
UT80I-DNE0-06.0-S30	6712212001	104		
UT80I-DPE0-06.0-S30	6712112001	104		

Ultrasonic Sensors (sort by article number)

Art. No.	Type	Page		
6711102001	UT18I-DPE0-02.0-C30	102		
6711102002	UT18I-DPE0-01.6-C30	101		
6711102003	UT18I-DPE0-0800-C30	102		
6711102004	UT18I-DPE0-0500-C30	101		
6711102005	UT18I-DPE0-0400-C30	100		
6711103001	UT30I-DPE0-03.5-C30	103		
6711202001	UT18I-DNE0-02.0-C30	102		
6711202002	UT18I-DNE0-01.6-C30	101		
6711202003	UT18I-DNE0-0800-C30	102		
6711202004	UT18I-DNE0-0500-C30	101		
6711202005	UT18I-DNE0-0400-C30	100		
6711203001	UT30I-DNE0-03.5-C30	103		
6711302001	UT18I-D00I-02.0-C30	102		
6711302002	UT18I-D00I-01.6-C30	101		
6711302003	UT18I-D00I-0800-C30	102		
6711302004	UT18I-D00I-0500-C30	101		
6711302005	UT18I-D00I-0400-C30	100		
6711303001	UT30I-D00I-03.5-C30	103		
6711402001	UT18I-D00U-02.0-C30	102		
6711402002	UT18I-D00U-01.6-C30	101		
6711402003	UT18I-D00U-0800-C30	102		
6711402004	UT18I-D00U-0500-C30	101		
6711402005	UT18I-D00U-0400-C30	100		
6711403001	UT30I-D00U-03.5-C30	103		
6712101001	UN12I-DPE0-0200-S30	100		
6712102001	UT18I-DPE0-02.0-S30	103		
6712102002	UT18I-DPE0-01.6-S30	101		
6712102003	UT18I-DPE0-0800-S30	102		
6712102004	UT18I-DPE0-0500-S30	101		
6712102005	UT18I-DPE0-0400-S30	100		
6712103001	UT30I-DPE0-03.5-S30	103		
6712112001	UT80I-DPE0-06.0-S30	104		
6712201001	UN12I-DNE0-0200-S30	100		
6712202001	UT18I-DNE0-02.0-S30	103		
6712202002	UT18I-DNE0-01.6-S30	101		
6712202003	UT18I-DNE0-0800-S30	102		
6712202004	UT18I-DNE0-0500-S30	101		
6712202005	UT18I-DNE0-0400-S30	100		
6712203001	UT30I-DNE0-03.5-S30	103		
6712212001	UT80I-DNE0-06.0-S30	104		
6712302001	UT18I-D00I-02.0-S30	103		
6712302002	UT18I-D00I-01.6-S30	101		
6712302003	UT18I-D00I-0800-S30	102		
6712302004	UT18I-D00I-0500-S30	101		
6712302005	UT18I-D00I-0400-S30	100		
6712303001	UT30I-D00I-03.5-S30	103		
6712312001	UT80I-D00I-06.0-S30	104		
6712402001	UT18I-D00U-02.0-S30	103		
6712402002	UT18I-D00U-01.6-S30	101		
6712402003	UT18I-D00U-0800-S30	102		
6712402004	UT18I-D00U-0500-S30	101		
6712402005	UT18I-D00U-0400-S30	100		
6712412001	UT80I-D00U-06.0-S30	104		
6713111001	UT25I-DPE0-0250-V30	104		
6713211001	UT25I-DNE0-0250-V30	104		
6713411001	UT25I-D00U-0250-V30	104		

Type Code

Float Switches, Standard Range

1	2	3	4	5	6	7	8	9	10	11	12	13						
M	A	A	-	7	1	3		K	S	S		1	0	0	0			
Product group		Immersion tube/float combination		General design		Number of switching points	Contact function	Switching power	Connection head	Range	Switch length in mm							

Product group		
1	M	Magnetic switch
2	Type of output	
	A	Reed contact
	I	Triac
Immersion tube/float combination		
3	Immersion tube material 1.4571	
	A	Cylindrical float rd. 40 x 27 POM
	V	Cylindrical float rd. 42 x 44 PVC
	T	Cylindrical float rd. 30 x 44 PP
	R	Cylindrical float rd. 30 x 44 NBR
	N	Cylindrical float rd. 45 x 47 1.4571
	E	Ball float rd. 52 1.4571
	B	Ball float rd. 62 1.4571
	G	Ball float rd. 84 1.4571
	Immersion tube material brass MS63	
	M	Cylindrical float rd. 40 x 27 POM
	L	Cylindrical float rd. 42 x 44 PVC
	C	Cylindrical float rd. 30 x 44 PP
	S	Cylindrical float rd. 30 x 44 NBR
	P	Cylindrical float rd. 45 x 47 1.4571
	F	Ball float rd. 52 1.4571
	O	Ball float rd. 62 1.4571
	H	Ball float rd. 84 1.4571
	Immersion tube material PVC	
	K	Cylindrical float rd. 40 x 27 POM
	D	Cylindrical float rd. 42 x 44 PVC
	I	Cylindrical float rd. 30 x 44 PP
	U	Cylindrical float rd. 30 x 44 NBR
4	-	Dash (fixed)

General design		
5	7	Float switch
Number of switching points		
6	1	1 switching point
	2	2 switching points
	...	etc.
Contact function		
7	1	NC contact
	2	NO contact
	3	Changeover contact
	4	Mixed configuration (NC, NO, CO)
8		Space (fixed)
Switching power		
9	B	250 V; 0.5 A; 10 VA
	F	250 V; 3.0 A; 100 VA
	K	250 V; 0.5 A; 30 VA
	L	250 V; 1.0 A; 60 VA
	P	250 V; 5.0 A; 250 VA
	X	100 V; 0.25 A; 5 VA
Connection head		
10	Straight immersion tube	
	A	Half cable gland G3/8"
	V	Cable gland PG9
	D	Degussa plastic enclosure
	F	Aluminium enclosure DIN 43729
	K	PVC screw connection R2" connector DIN 43650
	N	PVC screw connection R1.5" connector Amphenol
	O	PVC screw connection R2" connector Amphenol
	R	PVC screw connection R1.5" connector DIN 43650

	S	Flange enclosure rd. 78
	T	PC flange rd. 75 connector DIN 43650
	TO	PC oval flange connector DIN 43650
	FL120	Flange enclosure rd. 120
	DN50	Flange DN65 with enclosure 80 x 80
	DN65	Flange DN65 with enclosure 80 x 80
	R1,5	Tank cable gland R1.5" with enclosure 80 x 80
	R2	Tank cable gland R2" with enclosure 80 x 80
	Elbow immersion tube	
	C	Half cable gland G3/8"
	H	Cable gland PG9
	E	Degussa plastic enclosure
	G	Aluminium enclosure DIN 43729
	L	PVC screw connection R2" connector DIN 43650
	M	PVC screw connection R1.5" connector Amphenol
	P	PVC screw connection R2" connector Amphenol
	I	PVC screw connection R1.5" connector DIN 43650
	B	Flange enclosure rd. 78
	W	PC flange rd. 75 connector DIN 43650
	TW	PC oval flange connector DIN 43650
	WFL120	Flange enclosure rd. 120
	WDN50	Flange DN50 with enclosure 80 x 80
	WDN65	Flange DN65 with enclosure 80 x 80
Range		
11	S	Standard range
12		Space (fixed)
Switch length in mm		
13		Switch length - X

Adjustable Float Switches

1	2	3	4	5	6	7	8	9	10	11	12	13						
M	A	N	-	V	S	T	-	R	2,0	/	0	2	5	0				
Product group		Immersion tube/float combination		Type			Connection head			Switch length in mm								

Product group		
1 – 2	MA	Magnetic switch, reed contact
Immersion tube/float combination		
3	Immersion tube material 1.4571	
	N	Cylindrical float rd. 52 x 55 1.4571
	V	Cylindrical float rd. 52 x 55 PVC
	Immersion tube material brass MS63	
	P	Cylindrical float rd. 52 x 55 1.4571
	L	Cylindrical float rd. 52 x 55 PVC
	Immersion tube material brass MS63	
	D	Cylindrical float rd. 52 x 55 PVC
4	-	Dash (fixed)

Type		
5 – 7	VST	Adjustable
8	-	Dash (fixed)
Connection head		
9 – 11	R2,0	Tank cable gland R2" with enclosure 80 x 80
	R1,5	Tank cable gland R1.5" with enclosure 80 x 80
	FL165	Flange DN50 with enclosure 80 x 80
	FL185	Flange DN65 with enclosure 80 x 80
	FL120	Flange enclosure rd. 120
	FLS120	Flange enclosure rd. 120 with protective tube
12	/	Slash (fixed)
Switch length in mm		
13		Switch length – X

Miniature Float Switches

1	2	3	4	5	6	7	8	9	10				
MS	K1	-	PVC	-	R1/8	-	OSO		0	3	5	0	
Range	Float		Immersion tube material		Connection head		Position and number of switching points, with switching function		Switch length in mm				

Range		
1	MS	Miniature float switches
Float		
2	K1	rd. 25 x 20, PP
	K2	rd. 25 x 20, PVC
	K3	rd. 20 x 20, NBR
	K4	rd. 23 x 25, NBR
	K5	rd. 23 x 32, NBR
	K6	rd. 17,5 x 25, NBR
	K7	rd. 25 x 20, PVDF
	K8	rd. 25 x 20, PTFE
	N1	rd. 30, 1.4571
	KS	Pivoted float
3	-	Dash (fixed)
Immersion tube material		
4	NI	Stainless steel 1.4571
	MS	Brass MS63
	PVC	Polyvinyl chloride
	PP	Polypropylene
	POM	Polyacetal

Immersion tube material		
	PVDF	Polyvinyl idenfluoride
	PTFE	Polytetrafluoroethylene
	PA	Polyamide
5	-	Dash (fixed)
Connection head		
6	R1/8	Screw connection R1/8"
	R1/4	Screw connection R1/4"
	R3/8	Screw connection R3/8"
	R1	Screw connection R1"
	R1,5	Screw connection R1,5"
	PG7	Screw connection PG7
	PG9	Screw connection PG9
	M12X1	Screw connection M12x1
	M24X1	Screw connection M24x1
	F40	Flange, rd. 40
	FL75	Flange, rd. 75
	FL36	Flange, 36 x 36 with cable
	FL36ST	Flange, 36 x 36 with connector
	TO	Oval flange
	OV	No connection head

7	-	Dash (fixed)
Position and number of switching points, with switching function		
8	Switching function	
	O	NC contact
	S	NO contact
	U	Changeover contact
	Position and number	
	3 switching points	e.g. NC/NO/NC = top/middle/bottom
	2 switching points	e.g. CO/NO = top/bottom
	1 switching point	e.g. NC = bottom
9		Space
Switch length in mm		
10		Switch length - X

Options

1	2	3	4	5	6	7	8	9	10	11	12	13	14				
K	L	2	E	V	P	S	N	T	F	Z	I	D	G				

1	K	Short circuit-proof
2	L	LED
3	2	Cable length in m
4	E	Extended sensing distance (sn large)
5	V	Shortened type
6	P	Potentiometer
7	S	Device connector (terminals)
	PU	PUR cable
	SD	Connector to DIN 43650 (including socket)
	SM	Mini snap-in device connector
	S8	M8 device connector with union nut
	S12	Mini snap-in/M8 screw-on device connector
	SM8	M12 device connector with union nut, AC version
	S12A	M16 device connector with union nut and dust cap
	S16S	M12 Ultra-Lock device connector
	S12U	M5 x 0.5 device connector
	S5	Screw connection with cable

8	N	Stainless steel enclosure
9	T	Extended temperature range
10	F	Extended switching frequency
11	Z	Time-delayed
12	I	Programmable (intelligent)
13	D	ATEX products, dust Ex
14	G	ATEX products, gas Ex

Cable Connectors

1	2	3	4	5	6	7	8	9	10	11	12	13	14	15	16	17			
W	D	K	-	M	1	2	P	S	/	L	L	2	-	2	P	U			
Device specifications			Type of connection				Classification			LEDs			Cable length	Options					

Device specifications		
1		Cable output
	W	Elbow
	G	Straight
2		Product group
	D	Socket
	S	Connector (the sensor connections should always be used as the basis for connecting lines with different outputs)
	A	Adapter (socket and connector)
3		Preassembly
	K	Fixed cable
	A	Connection space, self-configurable
	V	Connecting line (extension)
4	-	Dash (fixed)
Type of connection		
5 - 7		Always related to the socket / connector
	M12	Union nut M12 x 1
	M08	Union nut M8 x 1
	R06	Round snap-in connection Ø 6.5 mm
	R12	Round snap-in connection, Ultra-Lock M12
	M05	M5 x 0.5 screw-on connection

Classification		
8		Configuration for switch output
	P	PNP (LED to negative)
	N	N = NPN (LED to positive)
	U	Universal (no LED)
	A	AC (M12 special coding Pin 1 + 2)
9		Pin assignments of cable sockets for switch output
	S	NO contact 1 - 3 - 4 for M12 1 - 3 - 2 for Mini 1 - 2 for M12 AC
	Ö	NC contact 1 - 3 - 2 for M12
	A	Antivalent 1 - 3 - 4 - 2 for M12
	N	NAMUR 1 - 3 for M12
	U	More than 4 connections
	T	Teach-in function
10	/	Slash (fixed)
Manufacturer		
11		Internal information

LEDs		
12	L	Integrated LED
	O	Without LED
13		Number of LEDs
	0	No LED
	1	1 LED
	2	2 LEDs etc.
14	-	Dash (fixed)
Cable length		
15		In m (moulded cable)
Options		
16 - 17	PU	Polyurethane cable
	HF	Highly flexible cable
	SD	Connector/socket
	BD	Socket both ends
	R	Vibration safeguard
	Without	PVC cable

Cable Connectors (sort by type designation)

Type	Art. No.	Page
GDA-M12UA/LO	4139100102	143
GDK-M08US/WO0-10	4139100797	142
GDK-M08US/WO0-2	4139100795	142
GDK-M08US/WO0-5	4139100796	142
GDK-M12US/WO0-10	4139100803	143
GDK-M12US/WO0-2	4139100801	143
GDK-M12US/WO0-5	4139100802	143
GDK-M12UU/HO-2PU	4139100956	143
GDK-R06US/SO0-2,5PU	4139100219	142
GDK-R06US/SO0-5PU	4139100220	142
GDK-R06US/SO0-10PU	4139100239	142
WDA-M12UA/LO	4139100101	143
WDK-M08PS/LL2-2	4139100213	142
WDK-M08PS/LL2-5	4139100216	142
WDK-M08US/WO0-10	4139100800	142
WDK-M08US/WO0-2	4139100798	142
WDK-M08US/WO0-5	4139100799	142
WDK-M12PA/SL2-10PU	4139100254	143
WDK-M12PA/SL2-2PU	4139100244	143
WDK-M12PA/SL2-5PU	4139100245	143
WDK-M12PS/LL2-2	4139100553	143
WDK-M12PS/LL2-6	4139100554	143
WDK-M12UA/WO0-10	4139100467	143
WDK-M12UA/WO0-5	4139100903	143
WDK-M12US/WO0-10	4139100805	143
WDK-M12US/WO0-2	4139100804	143
WDK-M12US/WO0-5	4139100468	143
WDK-R06US/SO0-2,5PU	4139100221	142
WDK-R06US/SO0-5PU	4139100222	142
WDK-R06US/SO0-10PU	4139100267	142

Mounting Material

1	2	3	4	5	6	7	8	9												
B	K	S	-	D	2	0	P	A												
Product group			Type group				Material													

Product group		
1	B	Mounting material
2		Type of product
	K	Retaining bracket
	W	Mounting bracket
	H	Retaining plate
3		Specification
	S	Bracket, 2-piece
	B	Block, 1-piece
	R	Reducer
	N	90° elbow
4	-	Dash (fixed)

Type group		
5 – 7		For clips:
		Diameter in mm corresponding to matching sensor
		For elbows: Type group
	e.g. L05	Light barrier OR05
	e.g. M06	Magnetic switch M06
Material		
8 – 9		Material
	ST	Steel
	NI	Stainless steel
	AL	Aluminium
	PA	Polyamide
	PP	Polypropylene

Wiring Diagrams

Types of Output DC 1

Cable colour abbreviations

BN = Brown

BU = Blue

BK = Black (switch output)

PNP output (circuit schematic)

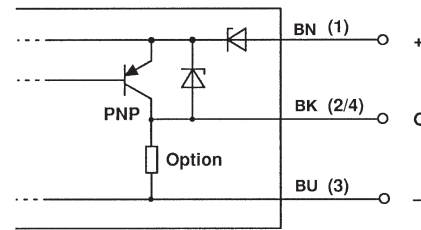

NPN output (circuit schematic)

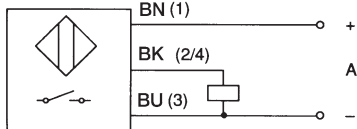
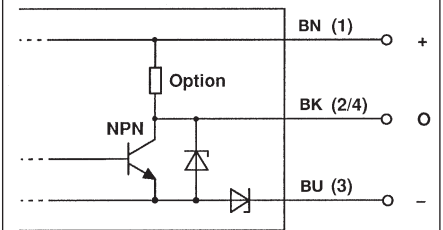

1) PNP normally-open contact

When actuated, a PNP transistor applies the output to positive.

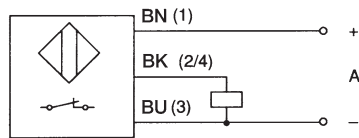

2) PNP normally-closed contact

When actuated, a PNP transistor disconnects the output from positive.

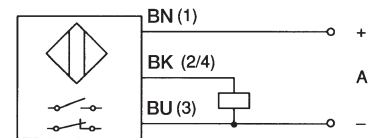

3) PNP programmable

The PNP NO contact 1) or PNP NC contact 2) function can be selected by means of a built-in changeover switch.

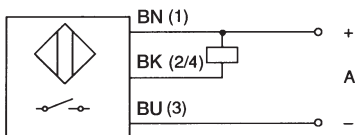

4) NPN normally-open contact

When actuated, a NPN transistor applies the output to negative.

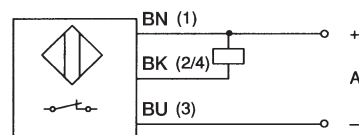

5) NPN normally-closed contact

When actuated, an NPN transistor disconnects the output from negative.

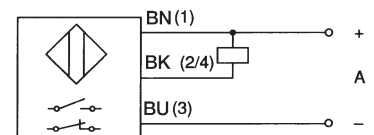

6) NPN programmable

The NPN NO contact 4) or NPN NC contact 5) function can be selected by means of a built-in changeover switch.

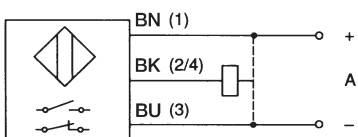

7) PNP/NPN programmable

Two built-in changeover switches are used to select between PNP or NPN switching and between NC or NO function.

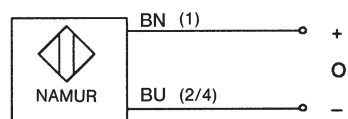

8) NAMUR

Current change to DIN EN 60947-5-6

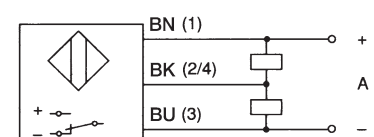

9) Push-pull programmable

When actuated, the output changes from negative to positive or, selectable with a built-in changeover switch, from positive to negative.

Types of Output DC 2

Cable colour abbreviations

BN = Brown
 BU = Blue
 BK = Black (switch output)
 WH = White (switch output)

DC 2-wire
 (circuit schematic)

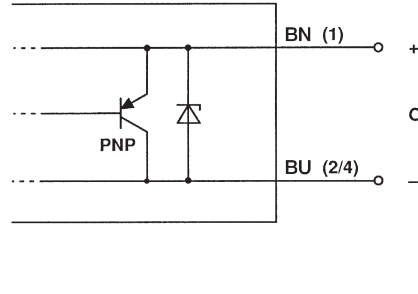

DC 4-wire
 (circuit schematic)

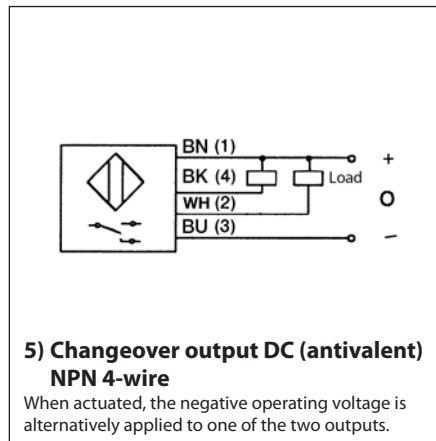
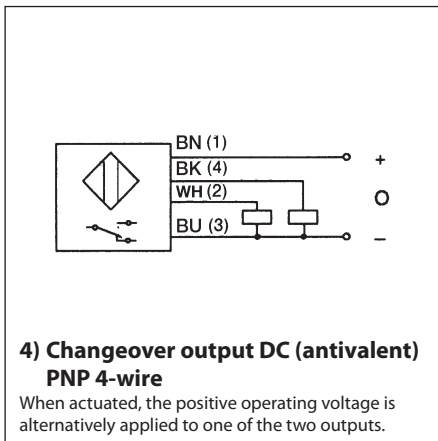
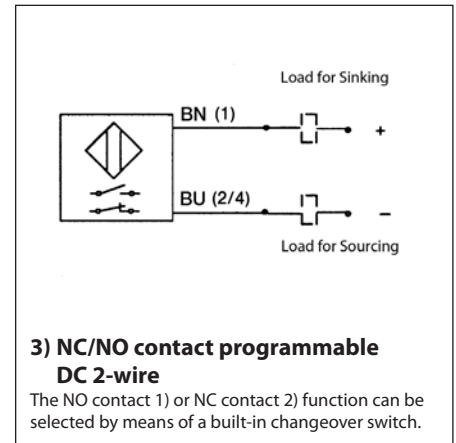
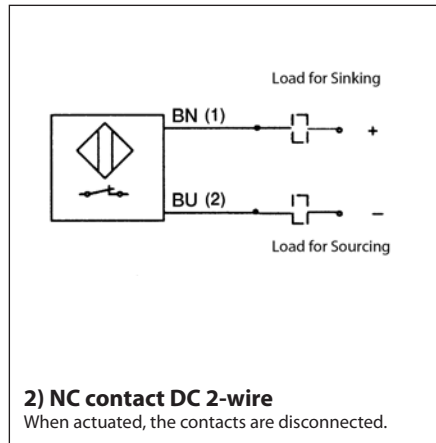
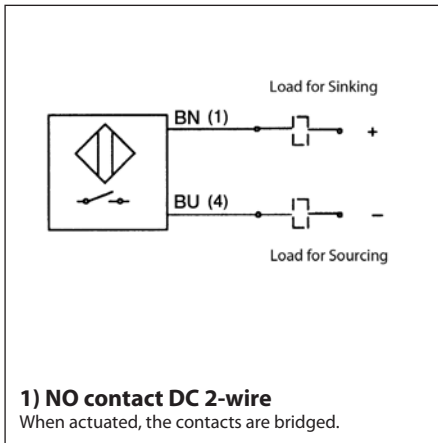
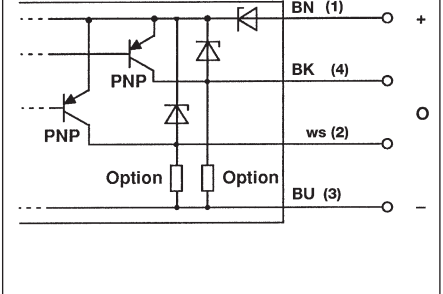

Wiring Diagrams

Types of Output AC 1

Cable colour abbreviations

BN = Brown
 BU = Blue
 BK = Black

AC 2-wire
 (circuit schematic)

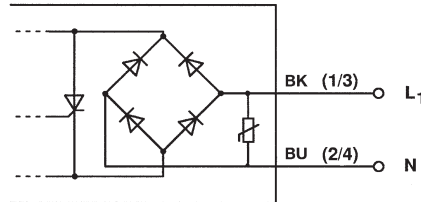

AC 3-wire
 (circuit schematic)

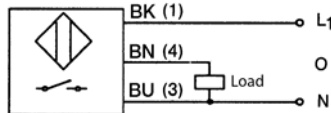
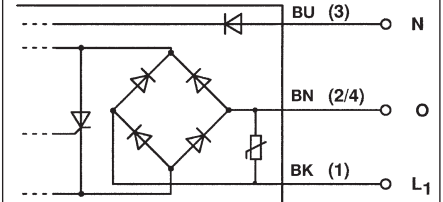

1) NO contact AC 3-wire

When actuated, a thyristor connected across a rectifier bridge applies the operating voltage to the output.

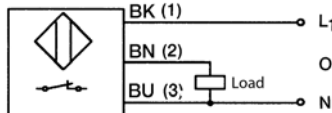

2) NC contact AC 3-wire

When actuated, a thyristor connected across a rectifier bridge disconnects the operating voltage from the output.

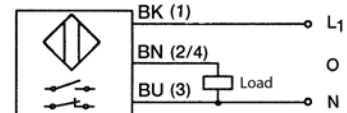

3) NC/NO contact programmable AC 3-wire

The AC NO contact 1) or AC NC contact 2) function can be selected by means of a built-in changeover switch.

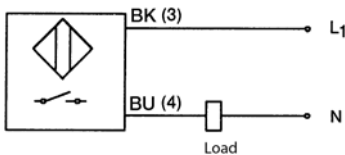

4) NO contact AC 2-wire

When actuated, a thyristor connected across a rectifier bridge applies the load to the operating voltage.

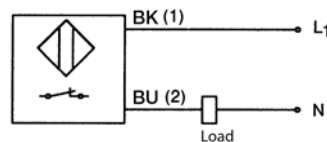

5) NC contact AC 2-wire

When actuated, a thyristor connected across a rectifier bridge disconnects the load from the operating voltage.

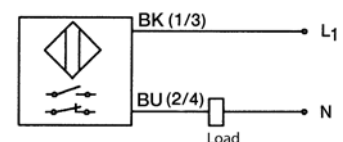

6) NC/NO contact programmable AC 2-wire

The AC NO contact 4) or AC NC contact 5) function can be selected by means of a built-in changeover switch.

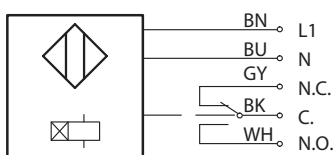

7) AC relay output

With adjustable pickup delay

Optoelectronic Sensors 1

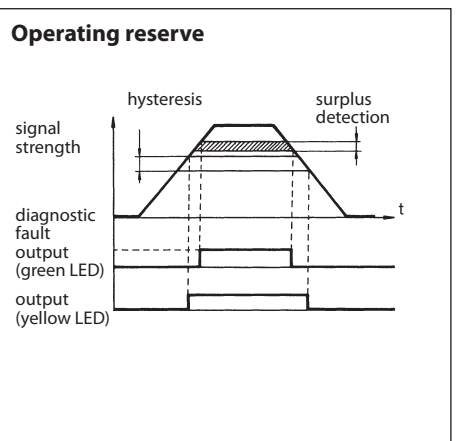
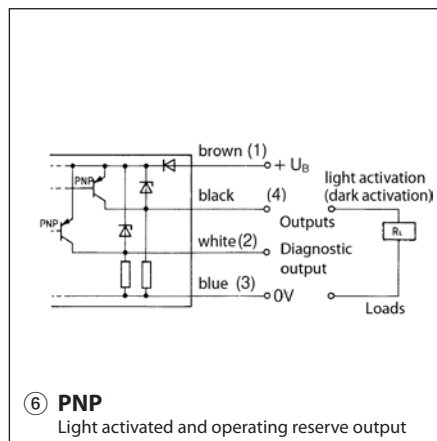
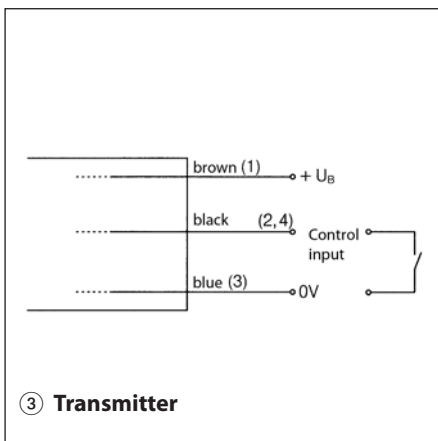
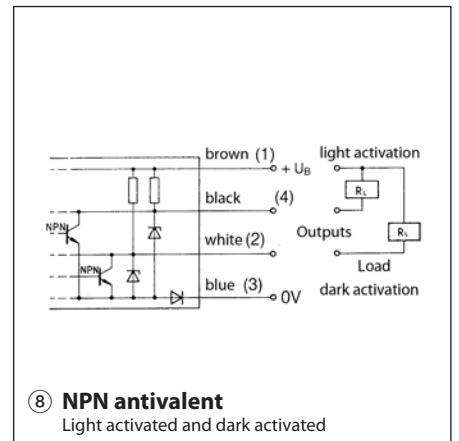
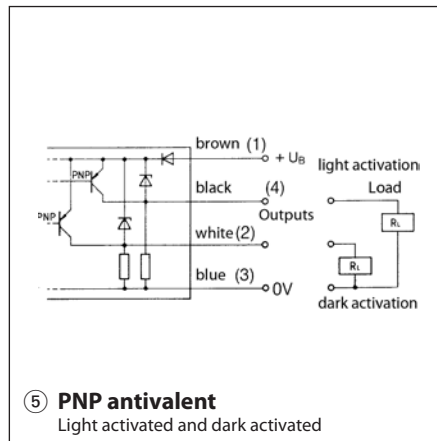
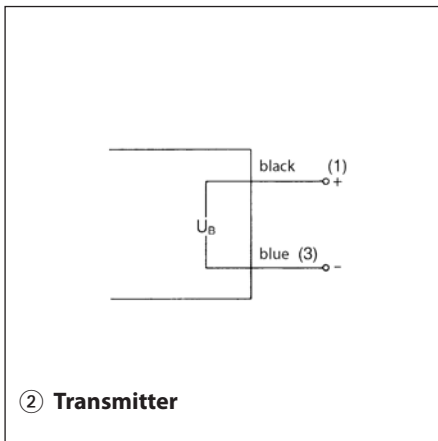
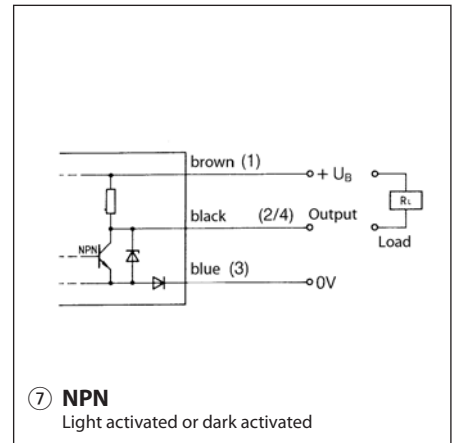
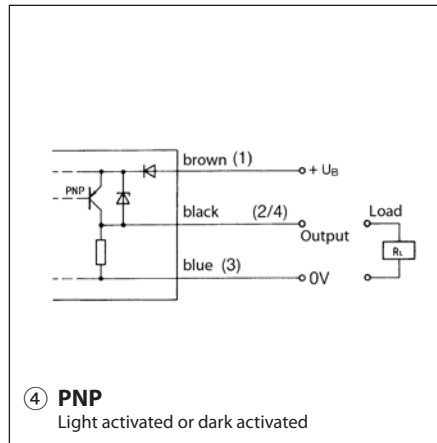
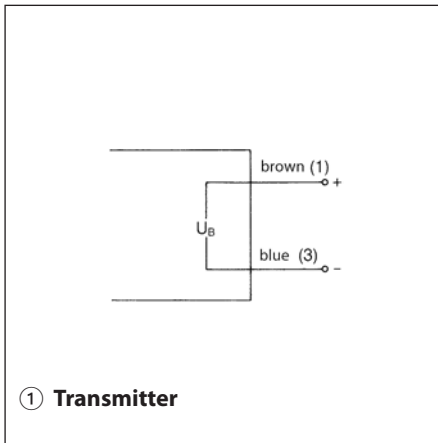

Wiring Diagrams

Optoelectronic Sensors 2

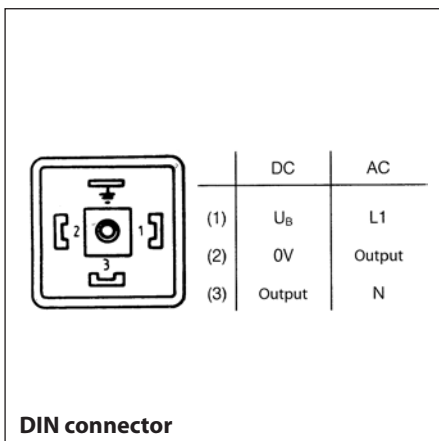
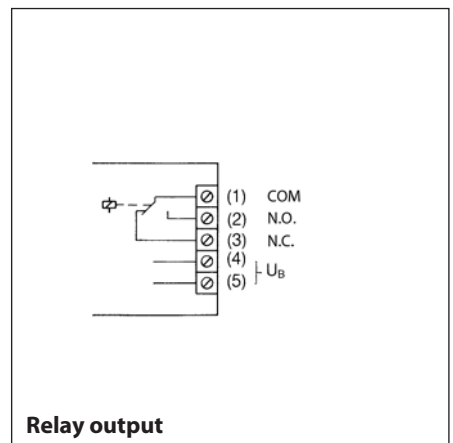
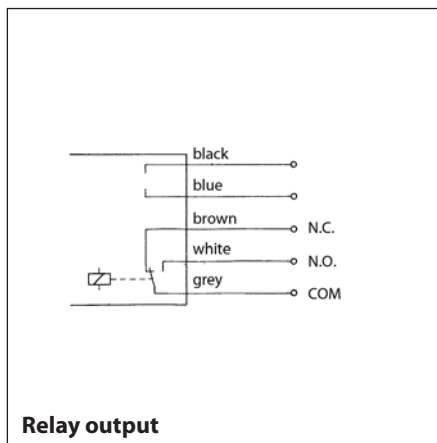
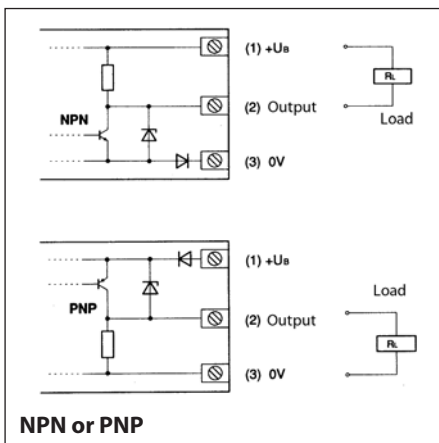
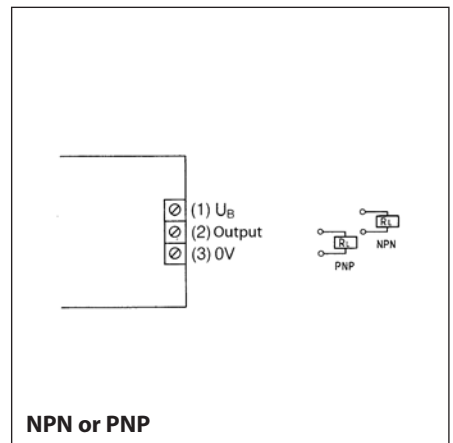
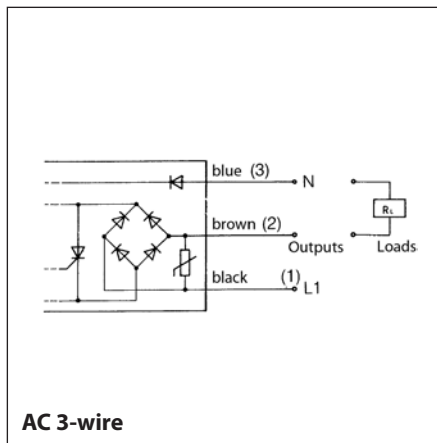
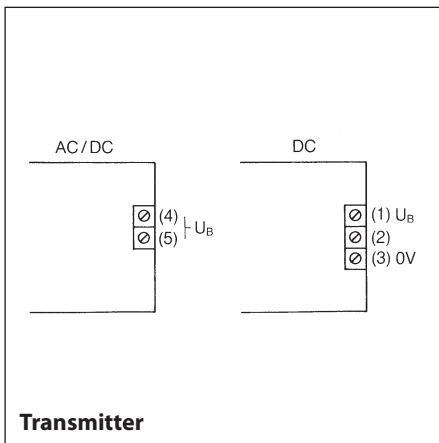







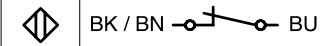

Type of Contact

Electric Loading Capacity of Reed Contacts AC/DC

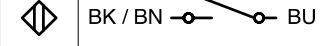
Contact type ID	Power	Voltage	Current
R	3 VA	28 V	0.25 A
X	5 VA	100 V	0.25 A
B	10 VA	250 V	0.5 A
Y	10 VA	100 V	0.5 A
A	20 VA	250 V	0.5 A
K	30 VA	250 V	0.5 A
H	60 VA	250 V	1.0 A
L	60 VA	250 V	1.0 A
M	80 VA	250 V	1.0 A
F	100 VA	250 V	3.0 A
G	250 VA*	250 V	5.0 A*
P	250 VA*	250 V	5.0 A*

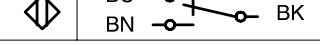
* Maximum make current for the duration of 2 ms
2.5 A; 100 W/VA in continuous operation

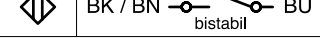
Wiring Diagrams Electromechanical Magnetic Switches

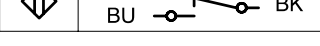
contact	 
NO contact	 
Changeover contact	 
Bistable ON-OFF	 S 
Bistable Changeover contact	 N 

Wiring Diagrams Electronic Magnetic Switches

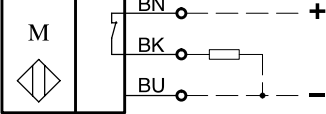
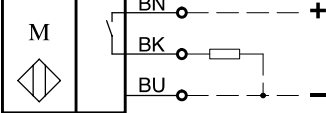
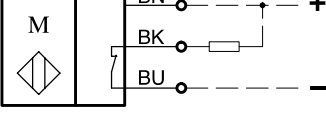
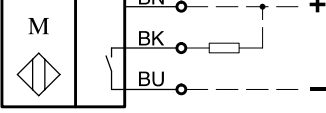
NC contact, PNP	
NO contact, PNP/PNP, bistable	
NC contact, NPN	
NO contact, NPN	



**Switch systems –
Economy meets safety**



**Sensor systems –
Compact intelligence**



**Enclosure systems –
Function and design**

www.bernstein.eu

Contact

**International Headquarters
BERNSTEIN AG**
Tieloser Weg 6
32457 Porta Westfalica
Phone +49 571 793-0
Fax +49 571 793-555
info@de.bernstein.eu
www.bernstein.eu

**Denmark
BERNSTEIN A/S**
Phone +45 7020 0522
Fax +45 7020 0177
info@dk.bernstein.eu

**France
BERNSTEIN S.A.R.L.**
Phone +33 1 64 66 32 50
Fax +33 1 64 66 10 02
info@fr.bernstein.eu

**Italy
BERNSTEIN S.r.l.**
Phone +39 035 4549037
Fax +39 035 4549647
info@it.bernstein.eu

**United Kingdom
BERNSTEIN Ltd**
Phone +44 1922 744999
Fax +44 1922 457555
info@uk.bernstein.eu

**Austria
BERNSTEIN GmbH**
Phone +43 2256 62070-0
Fax +43 2256 62618
info@at.bernstein.eu

**Switzerland
BERNSTEIN (Schweiz) AG**
Phone +41 44 775 71-71
Fax +41 44 775 71-72
info@ch.bernstein.eu

**Hungary
BERNSTEIN Kft.**
Phone +36 1 4342295
Fax +36 1 4342299
info@hu.bernstein.eu

**China
BERNSTEIN Safe Solutions
(Taicang) Co., Ltd.**
Phone +86 512 81608180
Fax +86 512 81608181
info@bernstein-safesolutions.cn